



RECEIVED-FPSC

00 JAN 25 PM 4:42

RECORDS AND REPORTING

January 24, 2000

Susan S. Masterton  
Attorney

Law/External Affairs  
Post Office Box 2214  
Tallahassee, FL 32318-2214  
Voice 850 599 1560  
Fax 850 878 0777  
susan.masterton@mail.sprint.com

Ms. Blanca S. Bayo, Director  
Division of Records and Reporting  
Florida Public Service Commission  
2540 Shumard Oak Boulevard  
Tallahassee, Florida 32399-0850

000085-TP

RE: Notice of Adoption of Covad/Sprint Interconnection and Resale Agreement  
by New Edge Networks, Inc. d/b/a New Edge Networks

Dear Ms. Bayo:

Sprint-Florida, Incorporated hereby provides notice to the Florida Public Service Commission of the adoption by New Edge Networks, Inc. d/b/a New Edge Networks, of the Interconnection and Resale Agreement for the State of Florida entered into by and between Sprint-Florida Incorporated and Covad Communications Company and approved by the Commission on November 8, 1999. New Edge Networks, is adopting the agreement as provided by Section 252(i) of the Telecom Act of 1996. Enclosed is the original signed and five (5) copies of the agreement between Sprint-Florida and New Edge Networks for your records.

Thank you for your assistance in this matter. If you have any questions, please do not hesitate to contact me at (850) 599-1560.

Sincerely,

Susan S. Masterton

Enclosures

cc: Walter D'Haeseleer  
Victor Cordiano

RECEIVED & FILED  
FPSC DIVISION OF RECORDS

DOCUMENT NUMBER-DATE  
01064 JAN 25 00  
FPSC-RECORDS/REPORTING

## **Master Network Interconnection and Resale Agreement**

This Master Network Interconnection and Resale Agreement ("Agreement") between New Edge Networks, Inc. d/b/a New Edge Networks and Sprint-Florida, Incorporated (Sprint), herein collectively, "the Parties", is entered into this 15th day of December, 1999 for the State of Florida and is effective upon this date or the date of Commission approval if required.

NOW THEREFORE, the parties agree as follows:

The Parties agree that the Agreement between the Parties shall consist of the Interconnection and Resale Agreement for the State of Florida entered into by and between Sprint and

Dieca Communications, Inc.

d/b/a Covad Communications Company

and filed with the Florida Commission on the 16th day of September, 1999 and approved on the 8<sup>th</sup> of November, 1999 (herein the "Covad - FL Agreement"), amended as follows:

### **TERM:**

This agreement shall be in force until the 31st day of July, 2001.

### **RATES:**

All rates provided under this agreement include the subsequent amendments executed by Sprint and Covad – FL.

### **CONDITIONS:**

All services provided under this agreement will be consistent with the decisions of courts having jurisdiction over this agreement, including but not limited to the decisions of the 8th Circuit Court of Appeals and the United States Supreme Court."

In Attachment III, Article 5, add a new Section 5.3.1 as follows:

- 5.3.1 If New Edge Networks requests an ADSL loop, for which the effective loop length exceeds the ADSL standard of 18 kft (subject to gauge design used in an area), Sprint will only provide a Non-Standard Data Line. Additional non-recurring charges for engineering and load coil removal will apply, plus trip charges and any applicable maintenance charges. Non-Standard Data Lines will not be subject to the performance measurements included in the interconnection agreement.

**NOTICES:**

Except as otherwise provided, all notices and other communication hereunder shall be deemed to have been duly given when made in writing and delivered in person or deposited in the United States mail, certified mail, postage paid, return receipt requested and addressed as follows:

To New Edge Networks      Ms. Stacey Waddell  
Vice-President – Carrier Relations  
New Edge Networks  
PO Box 5159  
3000 Columbia House Blvd  
Vancouver, WA 98668  
Facsimile: 360-693-9997

To Sprint:                      Vice-President - Carrier Services  
Mailstop: KSOPHM0316-3B925  
Sprint  
6480 Sprint Parkway  
Overland Park, KS 66251  
Facsimile: 913-315-0627

Copy To:                        Sprint  
Field Service Manager  
555 Lake Border Drive  
Apopka, FL 32703

New Edge Networks is hereby substituted in the Covad - FL Agreement for Covad - FL and Sprint is substituted for Company. The Agreement shall be modified as identified above and in all other respects the Covad - FL Agreement shall remain unchanged.

IN WITNESS WHEREOF, the Parties thereto have caused this Agreement to be executed by their duly respective authorized representatives.

Sprint-Florida, Incorporated

New Edge Networks

By: 

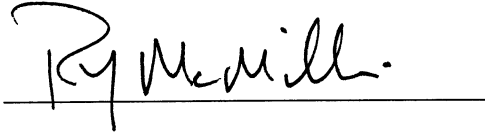
By: 

Name: William E. Cheek

Name: Robert Y. McMillin

Title: VP-Sales & Account Mgmt

Title: Director – Regulatory Affairs

Date: 12/20/99

Date: 12/14/99

ATTACHMENT: Interconnection and Resale Agreement for the State of Florida entered into by and between Sprint and Covad - FL filed with the Florida Commission on the 16<sup>th</sup> day of September, 1999 and approved on the 8<sup>th</sup> day of November, 1999.



**MASTER INTERCONNECTION AND RESALE AGREEMENT  
FOR THE STATE OF FLORIDA**

*AUGUST 1, 1999*

*DIECA COMMUNICATIONS, INC.*

*d/b/a COVAD COMMUNICATIONS COMPANY*

*and*

*SPRINT-FLORIDA, INCORPORATED*

## TABLE OF CONTENTS

Page No.

### **PART A - DEFINITIONS**

1. DEFINED TERMS .....	2
------------------------	---

### **PART B - GENERAL TERMS AND CONDITIONS**

1. SCOPE OF THIS AGREEMENT .....	12
2. REGULATORY APPROVALS.....	13
3. TERM AND TERMINATION.....	13
4. POST TERMINATION INTERIM SERVICE ARRANGEMENTS .....	14
5. CHARGES AND PAYMENT .....	15
6. AUDITS AND EXAMINATIONS .....	16
7. INTELLECTUAL PROPERTY RIGHTS.....	17
8. LIMITATION OF LIABILITY .....	18
9. INDEMNIFICATION .....	18
10. BRANDING.....	19
11. CONFIDENTIALITY AND PUBLICITY .....	19
12. DISCLAIMER OF WARRANTIES.....	21
13. ASSIGNMENT AND SUBCONTRACT.....	21
14. GOVERNING LAW .....	21
15. RELATIONSHIP OF PARTIES .....	21
16. NO THIRD PARTY BENEFICIARIES.....	22
17. NOTICES .....	22
18. WAIVERS .....	22
19. SURVIVAL.....	23
20. FORCE MAJEURE.....	23
21. DISPUTE RESOLUTION.....	23
22. COOPERATION ON FRAUD.....	24
23. TAXES .....	24
24. AMENDMENTS AND MODIFICATIONS .....	25

25. SEVERABILITY .....25

26. HEADINGS NOT CONTROLLING.....25

27. ENTIRE AGREEMENT .....25

28. COUNTERPARTS.....25

29. SUCCESSORS AND ASSIGNS.....25

30. IMPLEMENTATION PLAN.....25

31. FEDERAL JURISDICTIONAL AREAS.....27

**ATTACHMENT I - GENERAL PRINCIPLES**

1. PRICE SCHEDULE .....28

2. LOCAL SERVICE RESALE.....28

3. INTERCONNECTION AND RECIPROCAL COMPENSATION.....28

4. UNBUNDLED NETWORK ELEMENTS .....29

**ATTACHMENT II - LOCAL RESALE**

1. TELECOMMUNICATIONS SERVICES PROVIDED FOR RESALE.....49

2. GENERAL TERMS AND CONDITIONS.....49

**ATTACHMENT III - NETWORK ELEMENTS**

1. GENERAL.....52

2. UNBUNDLED NETWORK ELEMENTS .....52

3. BONA FIDE REQUEST PROCESS FOR FURTHER UNBUNDLING.....53

4. NETWORK INTERFACE DEVICE.....54

5. LOOP .....55

6. LOCAL SWITCHING.....57

7. TANDEM SWITCHING .....58

8. TRANSPORT.....60

9. SIGNALING SYSTEMS AND DATABASES.....60

10. OPERATOR SERVICES .....64

11. DIRECTORY ASSISTANCE SERVICE.....65

**ATTACHMENT IV - INTERCONNECTION**

1. LOCAL INTERCONNECTION TRUNK ARRANGEMENT .....66

2.	INTERCONNECTION COMPENSATION MECHANISMS.....	67
3.	SIGNALING.....	68
4.	NETWORK SERVICING.....	69
5.	NETWORK MANAGEMENT .....	70
6.	USAGE MEASUREMENT .....	71
7.	TRANSIT TRAFFIC .....	71
8.	RESPONSIBILITIES OF THE PARTIES .....	72
<b>ATTACHMENT V - INTERIM NUMBER PORTABILITY</b>		
1.	SPRINT PROVISION OF INTERIM NUMBER PORTABILITY.....	74
2.	INTERIM NUMBER PORTABILITY .....	74
3.	REQUIREMENTS FOR INP.....	75
<b>ATTACHMENT VI - LOCAL NUMBER PORTABILITY</b>		
1.	INTRODUCTION.....	78
2.	TRANSITION FROM INP TO LNP.....	78
3.	TESTING.....	79
4.	ENGINEERING AND MAINTENANCE.....	79
5.	E911/911.....	79
6.	BILLING .....	80
<b>ATTACHMENT VII - GENERAL BUSINESS REQUIREMENTS</b>		
1.	PROCEDURES.....	81
2.	ORDERING AND PROVISIONING .....	82
3.	BILLING .....	88
4.	PROVISION OF SUBSCRIBER USAGE DATA .....	89
5.	GENERAL NETWORK REQUIREMENTS .....	94
6.	MISCELLANEOUS SERVICES AND FUNCTIONS.....	96
<b>ATTACHMENT VIII - REPORTING STANDARDS</b>		
1.	GENERAL.....	110
2.	PARITY AND QUALITY MEASUREMENTS .....	110
<b>ATTACHMENT IX – PHYSICAL COLLOCATION.....</b>		



## INTERCONNECTION AND RESALE AGREEMENT

This Interconnection and Resale Agreement (the "Agreement"), entered into this *1st* day of *August*, 1999, is entered into by and between DIECA Communications, Inc. d/b/a Covad Communications Company ("Covad"), a California corporation, and Sprint-Florida, Incorporated ("Sprint"), a Florida corporation, to establish the rates, terms and conditions for local interconnection, local resale, and purchase of unbundled network elements (individually referred to as the "service" or collectively as the "services").

WHEREAS, the Parties wish to interconnect their local exchange networks for the purposes of transmission and termination of calls, so that customers of each can receive calls that originate on the other's network and place calls that terminate on the other's network, and for Covad's use in the provision of exchange access ("Local Interconnection"); and

WHEREAS, Covad wishes to purchase Telecommunications Services for resale to others, and Sprint is willing to provide such service; and

WHEREAS, COVAD COMMUNICATIONS COMPANY wishes to purchase unbundled network elements, ancillary services and functions and additional features ("Network Elements"), and to use such services for itself or for the provision of its Telecommunications Services to others, and Sprint is willing to provide such services; and

WHEREAS, the Parties intend the rates, terms and conditions of this Agreement, and their performance of obligations thereunder, to comply with the Communications Act of 1934, as amended (the "Act"), the Rules and Regulations of the Federal Communications Commission ("FCC"), and the orders, rules and regulations of the Florida Public Service Commission (the "Commission"); and

WHEREAS, the parties wish to replace any and all other prior agreements, written and oral, applicable to the state of Florida.

Now, therefore, in consideration of the terms and conditions contained herein, Covad and Sprint hereby mutually agree as follows:

## PART A -- DEFINITIONS

### 1. DEFINED TERMS

- 1.1. Certain terms used in this Agreement shall have the meanings as otherwise defined throughout this Agreement. Other terms used but not defined herein will have the meanings ascribed to them in the Act or in the Rules and Regulations of the FCC or the Commission. The Parties acknowledge that other terms appear in this Agreement which are not defined or ascribed as stated above. The parties agree that any such terms shall be construed in accordance with their customary usage in the telecommunications industry as of the effective date of this Agreement.
- 1.2. “911 Site Administrator” is a person assigned by Covad to establish and maintain E911 service location information for its subscribers.
- 1.3. “911 Service” means a universal telephone number which gives the public direct access to the Public Safety Answering Point (PSAP). Basic 911 service collects 911 calls from one or more local exchange switches that serve a geographic area. The calls are then sent to the correct authority designated to receive such calls.
- 1.4. “Access Service Request (ASR)” means the industry standard forms and supporting documentation used for ordering Access Services. The ASR may be used to order trunking and facilities between Covad and Sprint for Local Interconnection.
- 1.5. “Access Services” refers to interstate and intrastate switched access and private line transport services.
- 1.6. “Act” means the Communications Act of 1934, as amended.
- 1.7. “Affiliate” is as defined in the Act.
- 1.8. “Ancillary Traffic” means all traffic destined for ancillary services, or that may have special billing requirements, including, but not limited to the following:
  - 1.8.1. Directory Assistance;
  - 1.8.2. 911/E911;
  - 1.8.3. Operator call termination (busy line interrupt and verify); and Information services requiring special billing (e.g., 900 and 950).
- 1.9. “Automated Message Accounting (AMA)” is the structure inherent in switch technology that initially records telecommunication message information. AMA format is contained in the Automated Message Accounting document, published by Bellcore as GR-1100-CORE which defines the industry standard for message recording.
- 1.10. “Automatic Location Identification (ALI)” is a feature developed for E911 systems that provides for a visual display of the caller’s telephone number, address and the names of the emergency response agencies that are responsible for that address.

- 1.11. “Automatic Location Identification/Data Management System (ALI/DMS)” means the emergency service (E911/911) database containing subscriber location information (including name, address, telephone number, and sometimes special information from the local service provider) used to determine to which Public Safety Answering Point (PSAP) to route the call.
- 1.12. “ALI Gateway“ is a telephone company computer facility that interfaces with Covad’s 911 administrative site to receive Automatic Location Identification data from Covad.
- 1.13. “Automatic Number Identification (ANI)” is a feature that identifies and displays the number of a telephone line that originates a call.
- 1.14. “Automatic Route Selection (ARS)” is a service feature associated with a specific grouping of lines that provides for automatic selection of the least expensive or most appropriate transmission facility for each call based on criteria programmed into the system.
- 1.15. “ATU – C” refers to an ADSL Transmission Unit – Central Office.
- 1.16. “ATU – R” refers to an ADSL Transmission Unit – Remote.
- 1.17. “Busy Line Verify/Busy Line Verify Interrupt (BLV/BLVI)” means an operator call in which the caller inquires as to the busy status of, or requests an interruption of a call on another subscriber’s telephone line.
- 1.18. “Business Day(s)” means the days of the week excluding Saturdays, Sundays, and all Sprint holidays.
- 1.19. “Carrier Access Billing System (CABS)” is the system which is defined in a document prepared under the direction of the Billing Committee of the OBF. The CABS document is published by Bellcore in Volumes 1, 1A, 2, 3, 3A, 4 and 5 as Special Reports SR-OPT-001868, SR-OPT-001869, SR-OPT-001871, SR-OPT-001872, SR-OPT-001873, SR-OPT-001874, and SR-OPT-001875, respectively, and contains the recommended guidelines for the billing of access and other connectivity services. Sprint’s carrier access billing system is its Carrier Access Support System (CASS). CASS mirrors the requirements of CABS.
- 1.20. “Common Channel Signaling (CCS)” is a method of digitally transmitting call set-up and network control data over a digital signaling network fully separate from the public switched telephone network that carries the actual call.
- 1.21. “Calling Party Number (CPN)” is CCS parameter which refers to the number transmitted through the network identifying the calling party.
- 1.22. “Central Office Switch” (“Central Office”, or “CO”), “End Office”, or “Tandem”, or Remote Switch are switching facilities within the public switched telecommunications network, including, but not limited to:
  - 1.22.1. “End Office Switch” is a switch from which end user Telephone Exchange Services are directly connected and offered.
  - 1.22.2. “Tandem Switch” is a switch which is used to connect and switch trunk circuits

between and among Central Office Switches.

- 1.22.3. "Remote Switch" is a switch that is away from the host or control office. All or most of the central control equipment for the remote switch is located at the host or control office.
- 1.23. "Centrex" means a Telecommunications Service associated with a specific grouping of lines that uses central office switching equipment for call routing to handle direct dialing of calls, and to provide numerous private branch exchange-like features.
- 1.24. "Charge Number" is a CCS parameter which refers to the number transmitted through the network identifying the billing number of the calling party.
- 1.25. "CLASS/LASS" (Bellcore Service Mark) refers to service features that utilize the capability to forward a calling party's number between end offices as part of call setup. Features include Automatic Callback, Automatic Recall, Caller ID, Call Trace, and Distinctive Ringing.
- 1.26. "Competitive Local Exchange Carrier (CLEC) or Alternative Local Exchange Carrier (ALEC)" means any entity or person authorized to provide local exchange services in competition with an ILEC .
- 1.27. "Covad 911 Database Records" are the Covad subscriber records to be provided by Covad to Sprint for inclusion in Sprint's E911 database.
- 1.28. "Commission" means the Florida Public Service Commission.
- 1.29. "Common Transport" provides a local interoffice transmission path between the Sprint Tandem Switch and a Sprint or Covad end office switch. Common Transport is shared between multiple customers and is required to be switched at the Tandem.
- 1.30. "Confidential and/or Proprietary Information" has the meaning set forth in Article 11 of Part A -- General Terms and Conditions.
- 1.31. "Contract Year" means a twelve- (12) month period during the term of the contract commencing on the Effective Date and each anniversary thereof.
- 1.32. "Control Office" is an exchange carrier center or office designated as the Party's single point of contact for the provisioning and maintenance of its portion of local interconnection arrangements.
- 1.33. "Custom Calling Features" means a set of Telecommunications Service features available to residential and single-line business customers including call-waiting, call-forwarding and three-party calling.
- 1.34. "Customer Proprietary Network Information (CPNI)" means:
  - 1.34.1. information that relates to the quantity, technical configuration, type, destination, and amount of use of a Telecommunications Service subscribed to by any customer of a

Telecommunications Carrier, and that is made available to the carrier by the customer solely by virtue of the carrier customer relationship; and

- 1.34.2. information contained in the bills pertaining to telephone exchange service or telephone toll service received by a customer of a carrier.
- 1.35. “Database Management System (DBMS)” is a computer process used to store, sort, manipulate and update the data required to provide selective routing and ALI.
- 1.36. “Dedicated Transport” provides a local interoffice transmission path between Sprint and/or Covad central offices. Dedicated Transport is limited to the use of a single customer and does not require switching at a Tandem.
- 1.37. “Directory Assistance Database” refers to any subscriber record used by Sprint in its provision of live or automated operator-assisted directory assistance including but not limited to 411, 555-1212, NPA-555-1212.
- 1.38. “Directory Assistance Services” provides listings to callers. Directory Assistance Services may include the option to complete the call at the caller’s direction.
- 1.39. “Discloser” means that Party to this Agreement which has disclosed Confidential Information to the other Party.
- 1.40. “DSLAM” refers to a Digital Subscriber Line Access Multiplexer.
- 1.41. “Duct” is a single enclosed path to house facilities to provide telecommunications services.
- 1.42. “Enhanced 911 Service (E911)” means a telephone communication service which will automatically route a call dialed "9-1-1" to a designated public safety answering point (PSAP) attendant and will provide to the attendant the calling party’s telephone number and, when possible, the address from which the call is being placed and the emergency response agencies responsible for the location from which the call was dialed.
- 1.43. “E911 Message Trunk” is a dedicated line, trunk or channel between two central offices or switching devices which provides a voice and signaling path for E911 calls.
- 1.44. “Effective Date” is either thirty (30) days after the date referenced in the opening paragraph of the Agreement, the filing date of this Agreement with the Commission if the Commission has defined the Effective Date as such, or as otherwise required by the Commission.
- 1.45. “Electronic Interfaces” means access to operations support systems consisting of preordering, ordering, provisioning, maintenance and repair and billing functions.
- 1.46. “Emergency Response Agency” is a governmental entity authorized to respond to requests from the public to meet emergencies.
- 1.47. “EMI” (Exchange Message Interface System) is the Industry standard for exchanging telecommunications message information for billable, non-billable, sample settlement and study records. The EMI is published by ATIS (Alliance for Telecommunications Industry Solutions).”

- 1.48. “Environmental Hazard” means any substance the presence, use, transport, abandonment or disposal of which:
- 1.48.1. requires investigation, remediation, compensation, fine or penalty under any Applicable Law (including, without limitation, the Comprehensive Environmental Response Compensation and Liability Act, Superfund Amendment and Reauthorization Act, Resource Conservation Recovery Act, the Occupational Safety and Health Act and provisions with similar purposes in applicable foreign, state and local jurisdictions); or
  - 1.48.2. poses risks to human health, safety or the environment (including, without limitation, indoor, outdoor or orbital space environments) and is regulated under any Applicable Law.
- 1.49. “Emergency Service Number (ESN)” is a number assigned to the ALI and selective routing databases for all subscriber telephone numbers. The ESN designates a unique combination of fire, police and emergency medical service response agencies that serve the address location of each in-service telephone number.
- 1.50. “Enhanced Directory Assistance” refers to directory Assistance services, including but not limited to reverse search, talking yellow pages, and locator services.
- 1.51. “Expanded Interconnection Service (EIS)” is the collocation arrangement which Sprint provides in its designated wire centers.
- 1.52. “Grandfathered Service” means service which is no longer available for new customers and is limited to the current customer at their current locations with certain provisioning limitations, including but not limited to upgrade denials, feature adds/changes and responsible/billing party.
- 1.53. “FCC” means the Federal Communications Commission.
- 1.54. “Incumbent Local Exchange Carrier (ILEC)” means any local exchange carrier that was, as of February 8, 1996, deemed to be a member of the Exchange Carrier Association as set for the in 47 CFR § 69.601 (b) of the FCC’s regulations.
- 1.55. “Interexchange Carrier (IXC)” means a provider of interexchange telecommunications services.
- 1.56. “Interim Number Portability (INP)” is a service arrangement whereby subscribers who change local service providers may retain existing telephone numbers without impairment of quality, reliability, or convenience when remaining at their current location or changing their location within the geographic area served by the initial carrier’s serving central office. Upon implementation of Local Number Portability, defined herein, INP services will be discontinued.
- 1.57. “Line Information Data Base (LIDB)” means a Service Control Point (SCP) database that provides for such functions as calling card validation for telephone line number cards issued by Sprint and other entities and validation for collect and billed-to-third services.

- 1.58. “Local Loop” refers to a transmission path between the main distribution frame [cross-connect], or its equivalent, in a Sprint Central Office or wire center, and up to the Network Interface Device at a customer’s premises, to which Covad is granted exclusive use. This includes, but is not limited to, two-wire and four-wire cooper analog voice-grade loops, two-wire and four-wire loops that are conditioned to transmit the digital signals needed to provide services such as ISDN and DS1-level signals.
- 1.59. “Local Number Portability (LNP)” means the ability of users of Telecommunications Services to retain, at the same Sprint served rate center, existing telecommunications numbers without impairment of quality, reliability, or convenience when switching from one telecommunications carrier to another.
- 1.60. “Local Service Request (LSR)” means an industry standard form or a mutually agreed upon change thereof, used by the Parties to add, establish, change or disconnect local services.
- 1.61. “Local Traffic,” for the purposes of this Agreement the Parties shall agree that “Local Traffic” means traffic (excluding CMRS traffic) that is originated and terminated within Sprint’s local calling area, or mandatory expanded area service (EAS) area, as defined by State commissions or, if not defined by State commissions, then as defined in existing Sprint tariffs. For this purpose, Local Traffic does not include any traffic that is transmitted to or returned from the Internet at any point during the duration of the transmission between the Parties. Neither Party waives its’ rights to participate and fully present its’ respective positions in any proceeding dealing with the compensation for Internet traffic.
- 1.62. “Master Street Address Guide (MSAG)” is a database defining the geographic area of an E911 service. It includes an alphabetical list of the street names, high-low house number ranges, community names, and emergency service numbers provided by the counties or their agents to Sprint.
- 1.63. “Multiple Exchange Carrier Access Billing (MECAB)” refers to the document prepared by the Billing Committee of the Alliance for Telecommunications Industry Solutions’ (ATIS) Ordering and Billing Forum (OBF). The MECAB document contains the recommended guidelines for the billing of an access service provided to a customer by two or more providers or by one provider in two or more states within a single LATA.
- 1.64. “Multiple Exchange Carrier Ordering and Design (MECOD) Guidelines for Access Services - Industry Support Interface” refers to a document developed by the Ordering/Provisioning Committee of ATIS OBF. The MECOD document contains the recommended guidelines for processing orders for access service which is to be provided by two or more telecommunications carriers.
- 1.65. “North American Numbering Plan (NANP)” means the system or method of telephone numbering employed in the United States, Canada, and certain Caribbean countries. It denotes the three-digit Numbering Plan Area code and a seven digit telephone number made up of a three-digit Central Office code plus a four-digit station number.
- 1.66. “National Emergency Number Association (NENA)” is an association with a mission to foster the technological advancement, availability and implementation of 911 nationwide.

- 1.67. “Network Element” as defined in the Act.
- 1.68. “Numbering Plan Area (NPA)” (sometimes referred to as an area code) is the three-digit indicator which is designated by the first three digits of each 10-digit telephone number within the NANP. Each NPA contains 800 possible NXX Codes. There are two general categories of NPA, “Geographic NPAs” and “Non-Geographic NPAs.” A “Geographic NPA” is associated with a defined geographic area, and all telephone numbers bearing such NPA are associated with services provided within that geographic area. A “Non-Geographic NPA,” also known as a “Service Access Code (SAC Code)” is typically associated with a specialized telecommunications service which may be provided across multiple geographic NPA areas; 500, 800, 900, 700, and 888 are examples of Non-Geographic NPAs.
- 1.69. “NXX,” “NXX Code,” “NNX,” “COC,” “Central Office Code,” or “CO Code” is the three-digit switch entity indicator which is defined by the fourth, fifth and sixth digits of a 10-digit telephone number within NANP.
- 1.70. “OBF” means the Ordering and Billing Forum, which functions under the auspices of the Carrier Liaison Committee (CLC) of the Alliance for Telecommunications Industry Solutions (ATIS)
- 1.71. “Operator Systems” is the Network Element that provides operator and automated call handling with billing, special services, subscriber telephone listings, and optional call completion services.
- 1.72. “Operator Services” provides for:
- 1.72.1. operator handling for call completion (e.g., collect calls);
  - 1.72.2. operator or automated assistance for billing after the subscriber has dialed the called number (e.g., credit card calls); and
  - 1.72.3. special services (e.g., BLV/BLI, Emergency Agency Call).
- 1.73. “Parity” means, subject to the availability, development and implementation of necessary industry standard Electronic Interfaces, the provision by Sprint of services, Network Elements, functionality or telephone numbering resources under this Agreement to Covad, including provisioning and repair, at least equal in quality to those offered to Sprint, its Affiliates or any other entity that obtains such services, Network Elements, functionality or telephone numbering resources. Until the implementation of necessary Electronic Interfaces, Sprint shall provide such services, Network Elements, functionality or telephone numbering resources on a non-discriminatory basis to Covad as it provides to its Affiliates or any other entity that obtains such services, Network Elements, functionality or telephone numbering resources.
- 1.74. “P.01 Transmission Grade Of Service (GOS)” means a trunk facility provisioning standard with the statistical probability of no more than one call in 100 blocked on initial attempt during the average busy hour.
- 1.75. “Parties” means, jointly, Sprint-Florida, Incorporated and Covad, and no other entity,



affiliate, subsidiary or assign.

- 1.76. “Party” means either Sprint-Florida, Incorporated or Covad, and no other entity, affiliate, subsidiary or assign.
- 1.77. “Percent Local Usage (PLU)” is a calculation which represents the ratio of the local minutes to the sum of local and intraLATA toll minutes between exchange carriers sent over Local Interconnection Trunks. Directory assistance, BLV/BLVI, 900, and 976 transiting calls from other exchange carriers and switched access calls are not included in the calculation of PLU.
- 1.78. “Point Of Interconnection (POI)” is a mutually agreed upon point of demarcation where the networks of Sprint and Covad interconnect for the exchange of traffic.
- 1.79. “Point of Presence (POP)” means an IXC’s point of presence.
- 1.80. “Proprietary Information” shall have the same meaning as Confidential Information.
- 1.81. “Public Safety Answering Point (PSAP)” is the public safety communications center where 911 calls placed by the public for a specific geographic area will be answered.
- 1.82. “Rate Center” means the geographic point and corresponding geographic area which are associated with one or more particular NPA-NXX codes which have been assigned to Sprint or Covad for its provision of Basic Exchange Telecommunications Services. The “rate center point” is the finite geographic point identified by a specific V&H coordinate, which is used to measure distance-sensitive end user traffic to/from the particular NPA-NXX designations associated with the specific Rate Center. The “rate center area” is the exclusive geographic area identified as the area within which Sprint or Covad will provide Basic Exchange Telecommunications Services bearing the particular NPA-NXX designations associated with the specific Rate Center. The Rate Center point must be located within the Rate Center area.
- 1.83. “Recipient” means that party to this Agreement (a) to which Confidential Information has been disclosed by the other party or (b) who has obtained Confidential Information in the course of providing services under this Agreement.
- 1.84. “Rebranding” occurs when Covad purchases a wholesale service from Sprint when Covad’s brand is substituted for the Sprint brand.
- 1.85. “Reseller” is a category of Local Exchange service providers who obtain dial tone and associated Telecommunications Services from another provider for resale to their end user subscribers.
- 1.86. “Routing Point” means a location which Sprint or Covad has designated on its own network as the homing (routing) point for traffic inbound to Basic Exchange Services provided by Sprint or Covad which bear a certain NPA-NXX designation. The Routing Point is employed to calculate mileage measurements for the distance-sensitive transport element charges of Switched Access Services. Pursuant to Bellcore Practice BR 795-100-100, the Routing Point may be an “End Office” location, or a “LEC Consortium Point of Interconnection.” Pursuant to that same Bellcore Practice, examples of the latter shall be

designated by a common language location identifier (CLLI) code with (x)KD in positions 9, 10, 11, where (x) may be any alphanumeric A-Z or 0-9. The above referenced Bellcore document refers to the Routing Point as the Rating Point. The Rating Point/Routing Point need not be the same as the Rate Center Point, nor must it be located within the Rate Center Area, but must be in the same LATA as the NPA-NXX.

- 1.87. "Small Exchange Carrier Access Billing (SECAB)" means the document prepared by the Billing Committee of the OBF. The SECAB document, published by ATIS as Special Report SR OPT-001856, contains the recommended guidelines for the billing of access and other connectivity services.
- 1.88. "Selective Routing" is a service which automatically routes an E911 call to the PSAP that has jurisdictional responsibility for the service address of the telephone that dialed 911, irrespective of telephone company exchange or wire center boundaries.
- 1.89. "Signaling Transfer Point (STP)" means a signaling point that performs message routing functions and provides information for the routing of messages between signaling points within or between CCIS networks. A STP transmits, receives and processes CCIS messages.
- 1.90. "Switch" means a Central Office Switch as defined in this Part A.
- 1.91. "Switched Access Detail Usage Data" means a category 1101XX record as defined in the EMI Bellcore Practice BR 010-200-010.
- 1.92. "Switched Exchange Access Service" means the offering of transmission or switching services to Telecommunications Carriers for the purpose of the origination or termination of Telephone Toll Service. Switched Exchange Access Services include: Feature Group A, Feature Group B, Feature Group D, 800/888 access and 900 access and their successor or similar Switched Exchange Access Services.
- 1.93. "Synchronous Optical Network (SONET)" is an optical interface standard that allows interworking of transmission products from multiple vendors (i.e., mid-span meets). The base rate is 51.84 MHps (OC-1/STS-1 and higher rates are direct multiples of the base rate up to 1.22 GHps).
- 1.94. "Tandem Office Switches", "Tandem", and "Tandem Switching" describe Class 4 switches which are used to connect and switch trunk circuits between and among end office switches and other tandems.
- 1.95. "Tariff" means a filing made at the state or federal level for the provision of a telecommunications service by a telecommunications carrier that provides for the terms, conditions and pricing of that service. Such filing may be required or voluntary and may or may not be specifically approved by the Commission or FCC.
- 1.96. "Technically Feasible" refers solely to technical or operational concerns, rather than economic, space, or site considerations.
- 1.97. "Telecommunications" as defined in the Act.
- 1.98. "Telecommunications Carrier" as defined in the Act.

- 1.99. "Telecommunication Services" means the offering of Telecommunications for a fee directly to the public, or to such classes of users as to be effectively available directly to the public, regardless of the facilities used.
- 1.100. "Thousands Block Of Numbers" shall mean 1000 or more consecutive numbers beginning and ending on a digit boundary, e.g., 949-1000 to 949-1999.
- 1.101. "Transit Service" means the delivery of Local or non-Local Traffic by Sprint or Covad, that originated on one Party's network, transited through the other Party's network, and terminated to a third party Telecommunications Carrier's network.
- 1.102. "Transit Traffic" means Local or non-Local traffic that originated on one Party's network, transited through the other Party's network, and terminated to a third party Telecommunications Carrier's network.
- 1.103. "Trunk-Side" refers to a Central Office Switch connection that is capable of, and has been programmed to treat the circuit as, connecting to another switching entity or another central office switch. Trunk side connections offer those transmission and signaling features appropriate for the connection of switching entities, and cannot be used for the direct connection of ordinary telephone station sets.
- 1.104. "Voluntary Federal Subscriber Financial Assistance Programs" are government programs that subsidize the provision of Telecommunications Services to low-income subscribers, pursuant to requirements established by the appropriate state regulatory body.
- 1.105. "Wholesale Service" as defined in the Act.
- 1.106. "Wire Center" denotes a building or space within a building which serves as an aggregation point on a given carrier's network, where transmission facilities and circuits are connected or switched. Wire center can also denote a building in which one or more central offices, used for the provision of Basic Exchange Services and access services, are located. However, for purposes of EIC service, Wire Center shall mean those points eligible for such connections as specified in the FCC Docket No. 91-141, and rules adopted pursuant thereto.
- 1.107. "xDSL" refers to a generic term for a new series of high speed transmission protocols, equipment, and services designed to operate over copper wire. This series includes but is not limited to ADSL, VDSL, SDSL, and others.

**PART B – GENERAL TERMS AND CONDITIONS**

**1. SCOPE OF THIS AGREEMENT**

1.1. This Agreement, including Parts A, B, and Attachments I through VIII, specifies the rights and obligations of each party with respect to the establishment, purchase, and sale of Local Interconnection, resale of Telecommunications Services and Unbundled Network Elements. Certain terms used in this Agreement shall have the meanings defined in PART A -- DEFINITIONS, or as otherwise elsewhere defined throughout this Agreement. Other terms used but not defined herein will have the meanings ascribed to them in the Act, in the FCC's, and in the Commission's Rules and Regulations. PART B sets forth the general terms and conditions governing this Agreement. The attachments set forth, among other things, descriptions of the services, pricing, technical and business requirements, and physical and network security requirements.

**LIST OF ATTACHMENTS:**

I.	Price Schedule
II.	Local Resale
III.	Network Elements
IV.	Interconnection
V.	Interim Number Portability
VI.	Local Number Portability
VII.	General Business Requirements
VIII.	Reporting Standards
IX	Physical Collocation

- 1.2. Sprint and Covad agree that this Agreement does not limit Sprint's right to discontinue any interconnection arrangement, Telecommunications Service, or Network Element provided or required hereunder, unless such discontinuance goes against a Commission ruling. Sprint shall provide Covad with thirty (30) days prior written notice of such discontinuation of such service, element or arrangement. Sprint agrees to cooperate with Covad and/or the appropriate regulatory body with any transition resulting from such discontinuation of service and to minimize the impact to customers which may result from such discontinuance of service.
- 1.3. Sprint shall provide notice of network changes and upgrades in accordance with §§ 51.325 through 51.335 of Title 47 of the Code of Federal Regulations.
- 1.4. The services and facilities to be provided to Covad by Sprint in satisfaction of this Agreement may be provided pursuant to Sprint tariffs and then current practices. Should there be a conflict between the terms of this Agreement and any such tariffs and practices, the terms of the this agreement shall control to the extent allowed by law or Commission order. Where services and facilities provided by Sprint are not incorporated into this

Agreement, the terms of the tariff shall control the provision of such services and facilities.

## **2. REGULATORY APPROVALS**

- 2.1. This Agreement, and any amendment or modification hereof, will be submitted to the Commission for approval in accordance with § 252 of the Act within thirty (30) days after obtaining the last required Agreement signature. Sprint and Covad shall use their best efforts to obtain approval of this Agreement by any regulatory body having jurisdiction over this Agreement. In the event any governmental authority or agency rejects any provision hereof, the Parties shall negotiate promptly and in good faith such revisions as may reasonably be required to achieve approval.
- 2.2. The Parties acknowledge that the respective rights and obligations of each Party as set forth in this Agreement are based on the texts of the Act and the rules and regulations promulgated thereunder by the FCC and the Commission as of the Effective Date (“Applicable Rules”). In the event of any amendment of the Act, any effective legislative action or any effective regulatory or judicial order, rule, regulation, arbitration award, dispute resolution procedures under this Agreement or other legal action purporting to apply the provisions of the Act to the Parties or in which the FCC or the Commission makes a generic determination that is generally applicable which revises, modifies or reverses the Applicable Rules (individually and collectively, Amended Rules), either Party may, by providing written notice to the other Party, require that the affected provisions of this Agreement be renegotiated in good faith and this Agreement shall be amended accordingly to reflect the pricing, terms and conditions of each such Amended Rules relating to any of the provisions in this Agreement.
- 2.3. Notwithstanding any other provision of this Agreement to the contrary § 2.2 hereof shall control. Any rates, terms or conditions thus developed or modified shall be substituted in place of those previously in effect and shall be deemed to have been effective under this Agreement as of the effective date established by the amended rules, whether such action was commenced before or after the Effective Date of this Agreement. Should the Parties be unable to reach agreement with respect to the applicability of such order or the resulting appropriate modifications to this Agreement, either party may invoke the Dispute Resolution provisions of this Agreement, it being the intent of the parties that this Agreement shall be brought into conformity with the then current obligations under the Act as determined by the amended rules.
- 2.4. Additional services, beyond those specified herein, requested by either party relating to the subject matter of this Agreement will be incorporated into this Agreement by written amendment hereto.

## **3. TERM AND TERMINATION**

- 3.1. This Agreement shall be deemed effective upon the Effective Date, provided however that if Covad has any outstanding past due obligations to Sprint, this Agreement will not be effective until such time as any past due obligations with Sprint are paid in full. No order or request for services under this Agreement shall be processed before the Effective Date,

except as may otherwise be agreed in writing between the Parties, provided Covad has established a customer account with Sprint and has completed the Implementation Plan described in Article 30 hereof.

- 3.2. Except as provided herein, Sprint and Covad agree to provide service to each other on the terms defined in this Agreement for a period of **two (2) years** ending 7/31/2001 (“End Date”).
- 3.3. In the event that Covad desires uninterrupted service under this Agreement during negotiations, Covad shall provide to Sprint written notification appropriate under the Act, and if the Parties are actually in arbitration or mediation before the appropriate Commission or FCC prior to the End Date, this Agreement will continue in effect only until the issuance of an order approving the new Agreement, whether a final non-appealable order or not, by the Commission or FCC resolving the issues set forth in such arbitration or mediation request.
- 3.4. In the event of default, the non-defaulting Party may immediately terminate this Agreement in whole or in part. Default is defined to include:
  - 3.4.1. Either Party’s insolvency or initiation of bankruptcy or receivership proceedings by or against the Party; or
  - 3.4.2. Either Party’s material breach of any of the terms or conditions hereof, including the failure to make any undisputed payment when due provided that the non-defaulting Party so advises the defaulting Party in writing of the event of the alleged default and the defaulting Party does not remedy the alleged default within sixty (60) days after written notice thereof.
- 3.5. Termination of this Agreement for any cause shall not release either Party from any liability which at the time of termination has already accrued to the other Party or which thereafter may accrue in respect to any act or omission prior to termination or from any obligation which is expressly stated herein to survive termination.
- 3.6. In the event this agreement is terminated under § 3.4 Sprint may immediately discontinue processing orders for new service from Covad and file with the Commission to terminate this agreement and reassign Covad’s customers pursuant to the Commission’s guidelines for CLECs that abandon service.
- 3.7. Notwithstanding the above, should Sprint sell or trade substantially all the assets in an exchange or group of exchanges that Sprint uses to provide Telecommunications Services then Sprint will use its best efforts to incorporate appropriate continuity of service and continuity of agreement provisions into any sale or trade agreement so that Covad, its customers and its end-users will retain service continuity during the term of this agreement.

#### **4. POST TERMINATION INTERIM SERVICE ARRANGEMENTS**

- 4.1. In the event that this Agreement expires under § 3.2, it is the intent of the Parties to provide in this Article for interim service arrangements between the Parties at the time of expiration

so that service to end users will not be interrupted should a new agreement not be consummated prior to the End Date. Therefore, except in the case of termination as a result of either Party's default under § 3.4, or for termination upon sale under § 3.7, for service made available under this Agreement and existing as of the End Date, the Parties agree that those services may continue uninterrupted at the request of either Party provided that:

- 4.1.1. a new agreement is voluntarily entered into by the Parties; or
- 4.1.2. service is provided under such standard terms and conditions or tariffs approved by and made generally available by the Commission, if they exist at the time of termination; or
- 4.1.3. Covad elects to take service pursuant to the entire terms and conditions of an existing agreement between Sprint and another CLEC for the remaining term of that agreement. If neither § 4.1.1 or § 4.1.2 are in effect, and Covad does not designate an agreement under this subsection, Sprint may designate such agreement.

## **5. CHARGES AND PAYMENT**

- 5.1. In consideration of the services provided by Sprint under this Agreement, Covad shall pay the charges set forth in Attachment I subject to the provisions of §§ 2.2 and 2.3 hereof. The billing and payment procedures for charges incurred by Covad hereunder are set forth in Attachment VII.
- 5.2. In addition to any other applicable charges under this Article 5 and Attachment I, if Covad purchases unbundled Local Switching elements, Covad shall pay Sprint for intrastate toll minutes of use traversing such unbundled Local Switching elements, intrastate carrier common line and interconnection charges as outlined on Attachment I hereto and any explicit intrastate universal service mechanism based on access charges.
- 5.3. Subject to the terms of this Agreement, the Parties shall pay invoices by the due date shown on the invoice or within 30 days of the Bill date, whichever comes later. For invoices not paid when due, late payment charges will be assessed under § 5.66. If the payment due date is a Saturday, Sunday or a designated bank holiday, payment shall be made the next business day.
- 5.4. Billed amounts for which written, itemized disputes or claims have been filed are not due for payment until such disputes or claims have been resolved in accordance with the provisions governing dispute resolution of this Agreement. Itemized, written disputes must be filed with Sprint's National Exchange Access Center ("NEAC") no later than the due date of the related invoice. A copy of the dispute must be sent with the remittance of the remainder of the invoice.
- 5.5. If Bill has been disputed by Covad and the dispute is upheld by Sprint, and the payment by Covad has resulted in an overpayment, Sprint will refund the amount of overpayment to Covad with an additional payment equal to the lesser of one and one-half percent (1.5%) per month or the maximum rate allowed by law for commercial transactions, of the amount of the overpayment, calculated based on the number of months from the date Sprint received

- Covad's payment, until the overpayment amount is paid in full by Sprint.
- 5.6. Sprint will assess late payment charges to Covad equal to the lesser of one and one-half percent (1.5%) per month or the maximum rate allowed by law for commercial transactions, of the balance due, until the amount due is paid in full.
  - 5.7. In addition to late payment charges, Sprint will use the following collection procedures in connection with Covad's past due amounts.
    - 5.7.1. First, the late payment charge described in § 5.6 above will be added to accounts that are not paid within a thirty (30) day period.
    - 5.7.2. Second, a notice will be sent to Covad on day 31 stating that unless full payment is received within the next thirty (30) days Sprint will suspend processing new orders.
    - 5.7.3. Third, if the Covad account remains delinquent on day 61 Sprint will send a second notice to Covad stating that Sprint has suspended processing new orders and unless payment is received by day 90, service for all Covad end user customers will be suspended.
    - 5.7.4. Fourth, should the Covad account remain outstanding on day 91 Sprint will deny service and send a letter to Covad stating that their service has been suspended for non-payment.
  - 5.8. Sprint reserves the right to periodically revise its collection procedure to conform to then current business practices and regulations. Sprint will provide timely notification to Covad of changes to its collection practice in a manner consistent with its own customer notification.

## **6. AUDITS AND EXAMINATIONS**

- 6.1. As used herein "Audit" shall mean a comprehensive review of services performed under this Agreement; "Examination" shall mean an inquiry into a specific element of or process related to services performed under this Agreement billed amounts. Either party (the "Requesting Party") may perform one (1) Audit per twelve (12) month period commencing with the Effective Date. The Audit period will include no more than the preceding twelve (12) month period as of the date of the Audit request. The Requesting Party may perform Examinations as it deems necessary, with the assistance of the other Party, which will not be unreasonably withheld.
- 6.2. Upon thirty (30) days written notice by the Requesting Party to Audited Party, Requesting Party shall have the right through its authorized representative to make an Audit or Examination, during normal business hours, of any records, accounts and processes which contain information bearing upon the provision of the services provided and performance standards agreed to under this Agreement. Within the above-described thirty (30) day period, the Parties shall reasonably agree upon the scope of the Audit or Examination, the documents and processes to be reviewed, and the time, place and manner in which the Audit or Examination shall be performed. Audited Party agrees to provide Audit or Examination



support, including appropriate access to and use of Audited Party's facilities (e.g.: conference rooms, telephones, copying machines).

- 6.3. Each party shall bear its own expenses in connection with the conduct of the Audit or Examination. The reasonable cost of special data extraction required by the Requesting Party to conduct the Audit or Examination will be paid for by the Requesting Party. For purposes of this § 6.3, a "Special Data Extraction" shall mean the creation of an output record or informational report (from existing data files) that is not created in the normal course of business. If any program is developed to Requesting Party's specifications and at Requesting Party's expense, Requesting Party shall specify at the time of request whether the program is to be retained by Audited party for reuse for any subsequent Audit or Examination.
- 6.4. Adjustments based on the audit findings may be applied to the twelve (12) month period included in the audit. Adjustments, credits or payments shall be made and any corrective action shall commence within thirty (30) days from receipt of requesting Party's receipt of the final audit report to compensate for any errors or omissions which are disclosed by such Audit or Examination and are agreed to by the Parties. Interest shall be calculated in accordance with § 5.5 herein.
- 6.5. Neither such right to examine and audit nor the right to receive an adjustment shall be affected by any statement to the contrary appearing on checks or otherwise, unless such statement expressly waiving such right appears in writing, is signed by the authorized representative of the party having such right and is delivered to the other party in a manner sanctioned by this Agreement.
- 6.6. This Article 6 shall survive expiration or termination of this Agreement for a period of one (1) year after expiration or termination of this Agreement.

## **7. INTELLECTUAL PROPERTY RIGHTS**

- 7.1. Any intellectual property which originates from or is developed by a Party shall remain in the exclusive ownership of that Party. Except for a limited license to use patents or copyrights to the extent necessary for the Parties to use any facilities or equipment (including software) or to receive any service solely as provided under this Agreement, no license in patent, copyright, trademark or trade secret, or other proprietary or intellectual property right now or hereafter owned, controlled or licensable by a Party, is granted to the other Party or shall be implied or arise by estoppel.
- 7.2. Neither Party shall have any obligation to defend, indemnify or hold harmless, or acquire any license or right for the benefit of, or owe any other obligation or any liability to, the other Party based on or arising from any claim, demand, or proceeding by any third party alleging or asserting that the use of any circuit, apparatus or system, or the use of any software, or the performance of any service or method, or the provision or use of any facilities by either party under this Agreement, constitutes direct or contributory infringement, or misuse or misappropriation of any patent, copyright, trademark, trade secret, or any other proprietary or intellectual property right of any third party.

- 7.3. Following notice of an infringement claim against Sprint based on the use by Covad of a service or facility, Covad shall at Covad's expense, procure from the appropriate third parties the right to continue to use the alleged infringing intellectual property or if Covad fails to do so, Sprint may charge Covad for such costs as permitted under a Commission order.

## **8. LIMITATION OF LIABILITY**

- 8.1. Except as otherwise set forth in this Agreement, neither Party shall be responsible to the other for any indirect, special, consequential or punitive damages, including (without limitation) damages for loss of anticipated profits or revenue or other economic loss in connection with or arising from anything said, omitted, or done hereunder (collectively "Consequential Damages"), whether arising in contract or tort, provided that the foregoing shall not limit a Party's obligation under Article 9 to indemnify, defend, and hold the other party harmless against amounts payable to third parties. Notwithstanding the foregoing, except in case of willful misconduct or gross negligence, in no event shall Sprint's liability to Covad for a service outage exceed an amount equal to the proportionate charge for the service(s) or unbundled element(s) provided for the period during which the service was affected.

## **9. INDEMNIFICATION**

- 9.1. Each Party agrees to indemnify and hold harmless the other Party from and against claims for damage to tangible personal or real property and/or personal injuries arising out of the negligence or willful act or omission of the indemnifying Party or its agents, servants, employees, contractors or representatives. To the extent not prohibited by law, each Party shall defend, indemnify, and hold the other Party harmless against any loss to a third party arising out of the negligence or willful misconduct by such indemnifying Party, its agents, or contractors in connection with its provision of service or functions under this Agreement. Notwithstanding the above, in the case of any loss alleged or damage claim made by a Customer of either Party in connection with the service provided by that Party, and which allegation or claim relates in some way to a service provided under this Agreement, the Party whose customer alleged such loss shall indemnify the other Party and hold it harmless against any or all of such loss alleged by each and every Customer which arises out of the negligence or willful misconduct of the indemnifying Party. The indemnifying Party under this Article agrees to defend any suit brought against the other Party either individually or jointly with the indemnified Party for any such loss, injury, liability, claim or demand. The indemnified Party agrees to notify the other Party promptly, in writing, of any written claims, lawsuits, or demands for which it is claimed that the indemnifying Party is responsible under this Article and to cooperate in every reasonable way to facilitate defense or settlement of claims. The indemnifying Party shall have complete control over defense of the case and over the terms of any proposed settlement or compromise thereof. The indemnifying Party shall not be liable under this Article for settlement by the indemnified Party of any claim, lawsuit, or demand, if the indemnifying Party has not approved the settlement in advance, unless the indemnifying Party has had the defense of the claim, lawsuit, or demand tendered to it in writing and has failed to assume such defense. In the event of such failure to assume

defense, the indemnifying Party shall be liable for any reasonable settlement made by the indemnified Party without approval of the indemnifying Party.

- 9.2. Each Party agrees to indemnify and hold harmless the other Party from all claims and damages arising from the Indemnifying Party's discontinuance of service to one of the Indemnifying Party's subscribers for nonpayment.
- 9.3. When the lines or services of other companies and Carriers are used in establishing connections to and/or from points not reached by a Party's lines, neither Party shall be liable for any act or omission of the other companies or Carriers.
- 9.4. In addition to its indemnity obligations hereunder, each Party shall, to the extent allowed by law or Commission Order, provide, in its tariffs and contracts with its subscribers that relate to any Telecommunications Services or Network Element provided or contemplated under this Agreement, that in no case shall such Party or any of its agents, contractors or others retained by such Party be liable to any subscriber or third party for (i) any loss relating to or arising out of this Agreement, whether in contract or tort, that exceeds the amount such Party would have charged the applicable subscriber for the service(s) or function(s) that gave rise to such loss, and (ii) Consequential Damages (as defined in Article 8 above).

## **10. BRANDING**

- 10.1. Covad shall provide the exclusive interface to Covad subscribers, except as Covad shall otherwise specify for the reporting of trouble or other matters identified by Covad for which Sprint may directly communicate with Covad subscribers. In those instances where Covad requests that Sprint personnel interface with Covad subscribers, such Sprint personnel shall inform the Covad subscribers that they are representing Covad, or such brand as Covad may specify.
- 10.2. Other business materials furnished by Sprint to Covad subscribers shall bear no corporate name, logo, trademark or tradename.
- 10.3. Except as specifically permitted by a Party, in no event shall either Party provide information to the other Party's subscribers about the other Party or the other Party's products or services.
- 10.4. Sprint shall share pertinent details of Sprint's training approaches related to branding with Covad to be used by Sprint to assure that Sprint meets the branding requirements agreed to by the Parties.
- 10.5. This Article 10 shall not confer on either Party any rights to the service marks, trademarks and/or trade names owned by or used in connection with services by the other Party, except as expressly permitted in writing by the other Party.

## **11. CONFIDENTIALITY AND PUBLICITY**

- 11.1. All information which is disclosed by one party ("Disclosing Party") to the other ("Recipient") in connection with this Agreement, or acquired in the course of performance

of this Agreement, shall be deemed confidential and proprietary to the Disclosing Party and subject to this Agreement, such information including but not limited to, orders for services, usage information in any form, and CPNI as that term is defined by the Act and the rules and regulations of the FCC (“Confidential and/or Proprietary Information”).

- 11.2. During the term of this Agreement, and for a period of one (1) year thereafter, Recipient shall (i) use it only for the purpose of performing under this Agreement, (ii) hold it in confidence and disclose it only to employees or agents who have a need to know it in order to perform under this Agreement, and (iii) safeguard it from unauthorized use or Disclosure using no less than the degree of care with which Recipient safeguards its own Confidential Information.
- 11.3. Recipient shall have no obligation to safeguard Confidential Information (i) which was in the Recipient’s possession free of restriction prior to its receipt from Disclosing Party, (ii) which becomes publicly known or available through no breach of this Agreement by Recipient, (iii) which is rightfully acquired by Recipient free of restrictions on its Disclosure, or (iv) which is independently developed by personnel of Recipient to whom the Disclosing Party’s Confidential Information had not been previously disclosed. Recipient may disclose Confidential Information if required by law, a court, or governmental agency, provided that Disclosing Party has been notified of the requirement promptly after Recipient becomes aware of the requirement, and provided that Recipient undertakes all lawful measures to avoid disclosing such information until Disclosing Party has had reasonable time to obtain a protective order. Recipient agrees to comply with any protective order that covers the Confidential Information to be disclosed.
- 11.4. Each Party agrees that Disclosing Party would be irreparably injured by a breach of this Article 11 by Recipient or its representatives and that Disclosing Party shall be entitled to seek equitable relief, including injunctive relief and specific performance, in the event of any breach of this Article 11. Such remedies shall not be exclusive, but shall be in addition to all other remedies available at law or in equity.
- 11.5. Unless otherwise agreed, neither Party shall publish or use the other Party's logo, trademark, service mark, name, language, pictures, symbols or words from which the other Party's name may reasonably be inferred or implied in any product, service, advertisement, promotion, or any other publicity matter, except that nothing in this paragraph shall prohibit a Party from engaging in valid comparative advertising. This § 11.5 shall confer no rights on a Party to the service marks, trademarks and trade names owned or used in connection with services by the other Party or its Affiliates, except as expressly permitted by the other Party.
- 11.6. Notwithstanding the public nature of this Agreement, each Party shall obtain the other Party's prior approval before discussing specific provisions of this Agreement in any press release or in any press or media interviews. Such prior approval shall not be unreasonably withheld. In no event shall either Party mischaracterize the contents of this Agreement in any public statement or in any representation to a governmental entity or member thereof.
- 11.7. Except as otherwise expressly provided in this Article 11, nothing herein shall be construed as limiting the rights of either Party with respect to its customer information under any

applicable law, including without limitation § 222 of the Act.

## **12. DISCLAIMER OF WARRANTIES**

12.1. EXCEPT AS SPECIFICALLY PROVIDED ELSEWHERE IN THIS AGREEMENT TO THE CONTRARY, NEITHER PARTY MAKES ANY REPRESENTATIONS OR WARRANTIES, EXPRESS OR IMPLIED, WITH RESPECT TO QUALITY, FUNCTIONALITY OR CHARACTERISTICS OF THE SERVICES PROVIDED PURSUANT TO THIS AGREEMENT, INCLUDING, BUT NOT LIMITED TO, IMPLIED WARRANTIES OF MERCHANTABILITY AND/OR FITNESS FOR A PARTICULAR PURPOSE. NO REPRESENTATION OR STATEMENT MADE BY EITHER PARTY OR ANY OF ITS AGENTS OR EMPLOYEES, ORAL OR WRITTEN, INCLUDING, BUT NOT LIMITED TO, ANY SPECIFICATIONS, DESCRIPTIONS OR STATEMENTS PROVIDED OR MADE SHALL BE BINDING UPON EITHER PARTY AS A WARRANTY.

## **13. ASSIGNMENT AND SUBCONTRACT**

- 13.1. If any Affiliate of either Party succeeds to that portion of the business of such Party that is responsible for, or entitled to, any rights, obligations, duties, or other interests under this Agreement, such Affiliate may succeed to those rights, obligations, duties, and interest of such Party under this Agreement. In the event of any such succession hereunder, the successor shall expressly undertake in writing to the other Party the performance and liability for those obligations and duties as to which it is succeeding a Party to this Agreement. Thereafter, the successor Party shall be deemed Carrier or Sprint and the original Party shall be relieved of such obligations and duties, except for matters arising out of events occurring prior to the date of such undertaking.
- 13.2. Except as herein before provided, and except for an assignment confined solely to moneys due or to become due, any assignment of this Agreement or of the work to be performed, in whole or in part, or of any other interest of a Party hereunder, without the other Party's written consent, which consent shall not be unreasonably withheld or delayed, shall be void. It is expressly agreed that any assignment of monies shall be void to the extent that it attempts to impose additional obligations other than the payment of such moneys on the other Party or the assignee additional to the payment of such moneys.

## **14. GOVERNING LAW**

14.1. This Agreement shall be governed by and construed in accordance with the Act, orders of the Commission, and the FCC's Rules and Regulations, except insofar as state law may control any aspect of this Agreement, in which case the domestic laws of the State of Florida, without regard to its conflicts of laws principles, shall govern. In all other respects, in the event of a conflict between the provisions of this Agreement and the Act, the provisions of the Act shall govern.

## **15. RELATIONSHIP OF PARTIES**

15.1. It is the intention of the Parties that each Party shall be an independent contractor and nothing contained herein shall constitute the Parties as joint venturers, partners, employees or agents of one another, and neither Party shall have the right or power to bind or obligate the other.

**16. NO THIRD PARTY BENEFICIARIES**

16.1. The provisions of this Agreement are for the benefit of the Parties hereto and not for any other person, and this Agreement shall not provide any person not a party hereto with any remedy, claim, liability, reimbursement, right of action, or other right in excess of those existing without reference hereto. This shall not be construed to prevent Carrier from providing its Telecommunications Services to other carriers.

**17. NOTICES**

17.1. Except as otherwise provided herein, all notices or other communication hereunder shall be deemed to have been duly given when made in writing and delivered in person or deposited in the United States mail, certified mail, postage prepaid, return receipt requested and addressed as follows:

If to Sprint:	Director Local Carrier Markets Sprint 4220 Shawnee Mission Pkwy Mailstop KSFRWB0301 Fairway, KS 66205	If to Covad:	Vice President and General Counsel Covad Communications 2330 Central Expressway, Building B Santa Clara, CA 95050
with a copy to:	Regional Director Sprint Corp. 555 Lake Border Drive Apopka, FL 32703 Facsimile: 407-889-6779	With a Copy to:	

17.2. If personal delivery is selected to give notice, a receipt of such delivery shall be obtained. The address to which notices or communications may be given to either party may be changed by written notice given by such Party to the other pursuant to this Article 17.

**18. WAIVERS**

18.1. No waiver of any provisions of this Agreement and no consent to any default under this Agreement shall be effective unless the same shall be in writing and properly executed by or on behalf of the Party against whom such waiver or consent is claimed.

- 18.2. No course of dealing or failure of any Party to strictly enforce any term, right, or condition of this Agreement in any instance shall be construed as a general waiver or relinquishment of such term, right or condition.
- 18.3. Waiver by either party of any default by the other Party shall not be deemed a waiver of any other default.

## **19. SURVIVAL**

- 19.1. Termination of this Agreement, or any part hereof, for any cause shall not release either Party from any liability which at the time of termination had already accrued to the other Party or which thereafter accrues in any respect to any act or omission occurring prior to the termination or from an obligation which is expressly stated in this Agreement to survive termination including but not limited to §§ 5, 6, 7, 8, 11, 16, 18, 21.

## **20. FORCE MAJEURE**

- 20.1. Neither Party shall be held liable for any delay or failure in performance of any part of this Agreement from any cause beyond its control and without its fault or negligence, such as acts of God, acts of civil or military authority, embargoes, epidemics, war, terrorist acts, riots, insurrections, fires, explosions, earthquakes, nuclear accidents, floods, power blackouts, strikes, work stoppage affecting a supplier or unusually severe weather. However, even during situations of force majeure, Sprint shall provide service to Covad that is comparable to the service that it provides its retail customers, itself, or other CLECs. No delay or other failure to perform shall be excused pursuant to this Article 20 unless delay or failure and consequences thereof are beyond the control and without the fault or negligence of the Party claiming excusable delay or other failure to perform. In the event of any such excused delay in the performance of a Party's obligation(s) under this Agreement, the due date for the performance of the original obligation(s) shall be extended by a term equal to the time lost by reason of the delay. In the event of such delay, the delaying Party shall perform its obligations at a performance level no less than that which it uses for its own operations. In the event of such performance delay or failure by Sprint, Sprint agrees to resume performance in a nondiscriminatory manner and not favor its own provision of Telecommunications Services above that of Covad.

## **21. DISPUTE RESOLUTION**

- 21.1. The Parties recognize and agree that the Commission has continuing jurisdiction to implement and enforce all terms and conditions of this Agreement. Accordingly, the Parties agree that any dispute arising out of or relating to this Agreement that the Parties themselves cannot resolve may be submitted to the Commission for resolution. The Parties agree to seek expedited resolution by the Commission, and shall request that resolution occur in no event later than sixty (60) days from the date of submission of such dispute. If the Commission appoints an expert(s) or other facilitator(s) to assist in its decision making, each party shall pay half of the fees and expenses so incurred. During the Commission proceeding each Party shall continue to perform its obligations under this Agreement provided, however, that neither Party shall be required to act in any unlawful fashion. This

provision shall not preclude the Parties from seeking relief available in any other forum.

- 21.2. If any portion of an amount due to a Party (“the Billing Party”) under this Agreement is subject to a bona fide dispute between the Parties, the Party billed (the “Non-Paying Party”) shall within thirty (30) days of its receipt of the invoice containing such disputed amount give written notice to the Billing Party at the address(es) indicated in Article 17 herein of the amounts it disputes (“Disputed Amounts”) and include in such notice the specific details and reasons for disputing each item. The Non-Paying Party shall pay when due all undisputed amounts to the Billing Party, and shall include a copy of the dispute with the payment of the undisputed amounts. The balance of the Disputed Amount, after the necessary adjustments have been made for the disputed amounts found in Covad’s favor, shall be paid with late charges, if appropriate, upon final determination of such dispute.
- 21.3. If the Parties are unable to resolve the issues related to the Disputed Amounts in the normal course of business within thirty (30) days after delivery to the Billing Party of notice of the Disputed Amounts, each of the Parties shall appoint a designated representative that has authority to settle the dispute and that is at a higher level of management than the persons with direct responsibility for administration of this Agreement. The designated representatives shall meet as often as they reasonably deem necessary in order to discuss the dispute and negotiate in good faith in an effort to resolve such dispute. The specific format for such discussions will be left to the discretion of the designated representatives, however all reasonable requests for relevant information made by one Party to the other Party shall be honored.
- 21.4. If the Parties are unable to resolve issues related to the Disputed Amounts within thirty (30) days after the Parties’ appointment of designated representatives pursuant to § 21.3, then either Party may file a complaint with the Commission to resolve such issues or proceed with any other remedy pursuant to law or equity. The Commission may direct payment of any or all funds plus applicable late charges to be paid to either Party.

## **22. COOPERATION ON FRAUD**

- 22.1. The Parties agree that they shall cooperate with one another to investigate, minimize and take corrective action in cases of fraud. The Parties’ fraud minimization procedures are to be cost effective and implemented so as not to unduly burden or harm one party as compared to the other.

## **23. TAXES**

- 23.1. Any Federal, state or local excise, license, sales, use, or other taxes or tax-like charges (excluding any taxes levied on income) resulting from the performance of this Agreement shall be borne by the Party upon which the obligation for payment is imposed under applicable law, even if the obligation to collect and remit such taxes is placed upon the other Party. Any such taxes shall be shown as separate items on applicable billing documents between the Parties. The Party obligated to collect and remit taxes shall do so unless the other Party provides such Party with the required evidence of exemption. The Party so obligated to pay any such taxes may contest the same in good faith, at its own expense, and



shall be entitled to the benefit of any refund or recovery, provided that such party shall not permit any lien to exist on any asset of the other party by reason of the contest. The Party obligated to collect and remit taxes shall cooperate fully in any such contest by the other Party by providing records, testimony and such additional information or assistance as may reasonably be necessary to pursue the contest.

## **24. AMENDMENTS AND MODIFICATIONS**

24.1. No provision of this Agreement shall be deemed waived, amended or modified by either party unless such a waiver, amendment or modification is in writing, dated, and signed by both Parties.

## **25. SEVERABILITY**

25.1. Subject to Part B, Article 2, if any part of this Agreement is held to be invalid for any reason, such invalidity will affect only the portion of this Agreement which is invalid. In all other respects this Agreement will stand as if such invalid provision had not been a part thereof, and the remainder of the Agreement shall remain in full force and effect.

## **26. HEADINGS NOT CONTROLLING**

26.1. The headings and numbering of Articles, Sections, Parts and Attachments in this Agreement are for convenience only and shall not be construed to define or limit any of the terms herein or affect the meaning or interpretation of this Agreement.

## **27. ENTIRE AGREEMENT**

27.1. This Agreement, including all Parts and Attachments and subordinate documents attached hereto or referenced herein, all of which are hereby incorporated by reference herein, constitute the entire matter thereof, and supersede all prior oral or written agreements, representations, statements, negotiations, understandings, proposals, and undertakings with respect to the subject matter thereof.

## **28. COUNTERPARTS**

28.1. This Agreement may be executed in counterparts. Each counterpart shall be considered an original and such counterparts shall together constitute one and the same instrument.

## **29. SUCCESSORS AND ASSIGNS**

29.1. This Agreement shall be binding upon, and inure to the benefit of, the Parties hereto and their respective successors and permitted assigns.

## **30. IMPLEMENTATION PLAN**

30.1. This Agreement sets forth the overall standards of performance for services, processes, and systems capabilities that the Parties will provide to each other, and the intervals at which

those services, processes and capabilities will be provided. The Parties understand that the arrangements and provision of services described in this Agreement shall require technical and operational coordination between the Parties. Accordingly, the Parties agree to form a team (the "Implementation Team") that shall develop and identify those processes, guidelines, specifications, standards and additional terms and conditions necessary to support the terms of this Agreement. Each Party shall designate, in writing, no more than four (4) persons to be permanent members of the Implementation Team; provided that either Party may include in meetings or activities such technical specialists or other individuals as may be reasonably required to address a specific task, matter or subject. Each Party may replace its representatives by delivering written notice thereof to the other Party.

30.2. The agreements reached by the Implementation Team shall be documented in an operations manual (the "Implementation Plan") within one hundred-twenty (120) days of both Parties having designated members of the Implementation Team. The Implementation Plan shall address the following matters, and may include any other matters agreed upon by the Implementation Team:

- 30.2.1. the respective duties and responsibilities of the Parties with respect to the administration and maintenance of the interconnections (including signaling) specified in Attachment 3 and the trunk groups specified in Attachment 4 and, including standards and procedures for notification and discoveries of trunk disconnects;
- 30.2.2. disaster recovery and escalation provisions;
- 30.2.3. access to Operations Support Systems functions provided hereunder, including gateways and interfaces;
- 30.2.4. escalation procedures for ordering, provisioning, billing, and maintenance;
- 30.2.5. single points of contact for ordering, provisioning, billing, and maintenance;
- 30.2.6. service ordering and provisioning procedures, including provision of the trunks and facilities;
- 30.2.7. provisioning and maintenance support;
- 30.2.8. conditioning and provisioning of collocation space and maintenance of Virtually Collocated equipment;
- 30.2.9. procedures and processes for Directories and Directory Listings;
- 30.2.10. billing processes and procedures;
- 30.2.11. network planning components including time intervals;
- 30.2.12. joint systems readiness and operational readiness plans;
- 30.2.13. appropriate testing of services, equipment, facilities and Network Elements;
- 30.2.14. monitoring of inter-company operational processes;

- 30.2.15. procedures for coordination of local PIC changes and processing;
  - 30.2.16. physical and network security concerns; and
  - 30.2.17. Completion of CLEC Checklist and supporting documentation to establish a billing account; and
  - 30.2.18. such other matters specifically referenced in this Agreement that are to be agreed upon by the Implementation Team and/or contained in the Implementation Plan.
- 30.3. The Implementation Plan may be amended from time to time by the Implementation Team, as the team deems appropriate. Unanimous written consent of the permanent members of the Implementation Team shall be required for any action of the Implementation Team. If the Implementation Team is unable to act, the existing provisions of the Implementation Plan shall remain in full force and effect.

**31. FEDERAL JURISDICTIONAL AREAS**

- 31.1. Covad understands and agrees that this agreement serves as actual notice that Sprint and its Affiliates have entered into a binding contract to provide exclusive telecommunications services for the Army and Air Force Exchange Service (“AAFES”) during the term of this agreement. The AAFES contract specifies, among other things, that Sprint shall provide all telecommunications services to officer and enlisted temporary living facilities (commonly named Bachelor Officer Quarters and Bachelor Enlisted Quarters) and to all unaccompanied enlisted personnel barracks on United States Army bases. Covad agrees it will not market to or attempt to secure any customer located in an area governed by this exclusive telecommunications service provider contract.

IN WITNESS WHEREOF, each of the Parties has caused this Agreement to be executed by its duly authorized representatives.

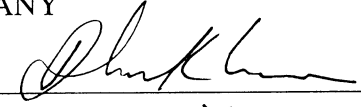
<b>“Sprint”</b>	SPRINT-FLORIDA, INCORPORATED	<b>“COVAD”</b>	DIECA COMMUNICATIONS, INC. d/b/a COVAD COMMUNICATIONS COMPANY
By: _____		By: _____	
Name (typed): _____	William E. Cheek	Name (typed): _____	Dhruv Khanna
Title: _____	VP – Sales & Acct Mgmt	Title: _____	Executive VP & General Counsel
Date: _____	<u>9/3/99</u>	Date: _____	<u>8/10/99</u>

**ATTACHMENT I**  
**GENERAL PRINCIPLES**

**1. PRICE SCHEDULE**

- 1.1. Subject to the provisions of Part B, Article 2 of this Agreement, all rates provided under this Agreement shall remain in effect for the term of this Agreement.

**2. LOCAL SERVICE RESALE**

- 2.1. The rates that Covad shall pay to Sprint for Local Resale are as set forth in Table 1 of this Attachment and shall be applied consistent with the provisions of Attachment II of this Agreement.

**3. INTERCONNECTION AND RECIPROCAL COMPENSATION**

- 3.1. The rates to be charged for the exchange of Local Traffic are set forth in Table 1 of this Attachment and shall be applied consistent with the provisions of Attachment IV of this Agreement. . Under this agreement, Sprint is only required to compensate COVAD for terminating Local Traffic.
- 3.2. Compensation for the termination of toll traffic and the origination of 800 traffic between the interconnecting parties shall be based on the applicable access charges in accordance with FCC and Commission Rules and Regulations and consistent with the provisions of Attachment IV of this Agreement.
- 3.3. INP is available in all Sprint service areas where LNP is not available. Once LNP is available, all INP arrangements will be converted to LNP. Where INP is available and a toll call is completed through Sprint's INP arrangement (e.g., remote call forwarding) to Covad's subscriber, Covad shall be entitled to applicable access charges in accordance with the FCC and Commission Rules and Regulations. If a national standard billing method has not been developed for a Covad to directly bill a carrier access for a toll call that has been completed using interim number portability, then the blended rate per line method described in § 3.3.1 herein will be used.
- 3.3.1. The Parties will jointly determine the amount of traffic that will be considered INP'ed traffic for compensation purposes. The ported party shall charge the porting party on a per line basis using an average of Sprint's per line minutes of use and Sprint's access rates in lieu of any other compensation charges for terminating such traffic. The traffic that is not identified as INP'ed will be compensated as local interconnection as set forth in § 3.1.
- 3.3.2. For compensation of the INP Local Traffic, the Parties shall jointly develop a process which will allow compensation for INP'ed traffic to be based on the initial origination point and final terminated point of the INP'ed call. The full reciprocal compensation rate, as listed in the Pricing Schedule, shall apply for Local Traffic, and full switched access charges, as listed in applicable tariffs, shall apply for

intraLATA and interLATA. All three sets of rates will be weighted together based on the agreed minutes of use patterns to establish a single rate per INP line.

- 3.3.3. Covad shall pay a transit rate, comprised of the transport and tandem rate elements, as set forth in Table 1 of this Attachment when Covad uses a Sprint access tandem to terminate a local call to a third party LEC or another CLEC. Sprint shall pay Covad a transit rate equal to the Sprint rate referenced above when Sprint uses a Covad switch to terminate a local call to a third party LEC or another CLEC.
- 3.4. To receive reciprocal compensation for local calls, the call must both originate and terminate within the Sprint's tariffed local calling area, including mandatory EAS areas. Covad will identify the Percent Local Usage (PLU) factor on each interconnection order to identify the "Local Traffic", as defined herein, that will be considered as local for reciprocal compensation purposes. Sprint may request Covad's traffic study documentation of the PLU at any time to verify the factor, and may compare the documentation to studies developed by Sprint. Should the documentation indicate that the factor should be changed by Sprint, the Parties agree that any changes will only be retroactive to traffic for the previous 90 days. For non-local traffic, the Parties agree to exchange traffic and to compensate one another based on the rates and elements included in each Party's access tariffs.

#### 4. UNBUNDLED NETWORK ELEMENTS

- 4.1. The charges that Covad shall pay to Sprint for unbundled local loops are set forth in the table associated with 47 CFR §51.513. After the Commission conducts a pricing procedure in conformity with the FCC pricing rules (47 CFR §51.501 et seq), the Parties shall amend Table 1 of this Attachment I to include charges for unbundled local loops.
- 4.2. The charges that Covad shall pay to Sprint for other Unbundled Network Elements are set forth in Table 1 of this Attachment I.

**TABLE 1**

RESALE DISCOUNTS			
Other than Operator/DA		19.40%	
Op Assist/DA		12.10%	
USAGE FILE CHARGES:			
Message Provisioning, per message		\$0.005	
Data Transmission, per message		\$0.002	
Tape Charge, per tape		\$50.00	
RATE ELEMENT	SOURCE	RECURRING RATE	NRC
Service Order NRC			\$25.15
Service Order Listing Only			\$20.82
Central Office Interconnection Charge			\$10.27
Trip Charge			\$18.41
Outside Plant Interconnection (2-W)			\$59.75
Outside Plant Interconnection (4-W)			\$74.72

NID Installation Charge			\$37.36
NID Connection Charge			\$18.68
Testing			\$1.42
Loop Rework Charge (2-W)			\$37.38
Loop Rework Charge (4-W)			\$62.41
Trouble Isolation and Testing			\$66.58
OSS Service Charge		\$1.77	
<b>Bona Fide Requests</b>			
Cancellation Charges			ICB
New Unbundled Network Element (s)		ICB	ICB
New Point(s) of Interconnection		ICB	ICB
<b>Authorization/Agency</b>			
<b>Presubscription, per telephone service line or trunk</b>			
To change intralata toll carrier or interlata carrier			\$4.80
To change both intralata toll carrier and interlata carrier			
if same carrier			\$4.80
- if different carriers			\$6.24
<b>Disputed Transfer</b>			
Per residence line or trunk			\$50.00
Per Business line or trunk			\$60.00
<b>NID</b>			
1 Line		\$0.79	See NRC Section
2 Line		\$0.95	See NRC Section
SmartJack		\$12.37	See NRC Section
<b>LOOP</b>			
Analog 2-wire	Band 1	\$10.78	See NRC Section
	Band 2	\$15.41	See NRC Section
	Band 3	\$20.54	See NRC Section
	Band 4	\$27.09	See NRC Section
	Band 5	\$39.66	See NRC Section
	Band 6	\$74.05	See NRC Section
Analog 4-wire	Band 1	\$18.80	See NRC Section
	Band 2	\$26.88	See NRC Section
	Band 3	\$35.85	See NRC Section
	Band 4	\$47.24	See NRC Section
	Band 5	\$69.17	See NRC Section
	Band 6	\$129.13	See NRC Section
DS0 2 Wire Digital Data Loop or Interconnection ADSL/ISDN-BRI			
	Band 1	\$11.65	\$89.14
	Band 2	\$16.65	\$89.14
	Band 3	\$22.20	\$89.14
	Band 4	\$29.26	\$89.14
	Band 5	\$42.84	\$89.14
	Band 6	\$79.98	\$89.14

DS0 4 Wire Digital Data Loop 56 or 64 kbps			
	Band 1	\$20.30	\$89.14
	Band 2	\$29.03	\$89.14
	Band 3	\$38.72	\$89.14
	Band 4	\$51.02	\$89.14
	Band 5	\$74.70	\$89.14
	Band 6	\$139.46	\$89.14
DS1 4 Wire Digital Data Loop DS1/T1/ISDN-PRI			
	Band 1	\$64.49	\$112.75
	Band 2	\$74.96	\$112.75
	Band 3	\$84.83	\$112.75
	Band 4	\$97.36	\$112.75
	Band 5	\$124.02	\$112.75
	Band 6	\$194.40	\$112.75
	DS3	ICB	
<b>Local Switching</b>			
	Band 1	\$4.44	See NRC Section
	Band 2	\$4.99	See NRC Section
	Band 3	\$5.77	See NRC Section
	Band 4	\$6.59	See NRC Section
	Band 5	\$7.40	See NRC Section
	Band 6	\$8.43	See NRC Section
	ISDN	ICB	
	CENTREX	ICB	
	PBS	ICB	
	DS1	ICB	
<b>FEATURES</b>			
	CCF Package *	\$0.23	\$3.21
	CLASS Package *	\$4.74	\$5.76
	CENTREX Package *	\$10.47	\$36.66
	- 3 Way Conf/Consult/Hold Transfer	\$1.80	\$21.12
	- Conf Calling - 6 Way Station Control	\$2.35	\$31.00
	- Dial Transfer to Tandem Tie Line	\$0.12	\$141.86
	- Direct Connect	\$0.03	\$24.28
	- Meet Me Conference	\$17.03	\$44.86
	- Multi-Hunt Service	\$0.08	\$27.05
<b>INTERIM NUMBER PORTABILITY</b>			
	RCF Residential	Commission Order	\$0.00
	RCF Business	Commission Order	\$0.00
	Call Path Residential	Commission Order	\$0.00
	Call Path Business	Commission Order	\$0.00

	Should be tracking for potential recovery through permanent number portability.	Will be determined in Florida docket 950737-TP	
<b>INP RATES SPECIFIC TO ACCESS SETTLEMENTS</b>			
	Per INP Line	\$5.89	
<b>TANDEM SWITCHING</b>			
		\$0.002085	
<b>TRANSPORT</b>			
	DS1	See attached transport worksheet	\$222.95
	DS3	See attached transport worksheet	\$249.16
	Common	\$0.000711	N/A
<b>RECIPROCAL COMPENSATION</b>			
	End Office	\$0.003671	NA
	Tandem Switching	\$0.002085	NA
	Transport		
	DS1	Rate Varies	\$222.95
	DS3	Rate Varies	\$249.16
	Common	\$0.000711	N/A
<b>INTERCONNECTION</b>			
These rates apply when collocation is not involved. For collocation rates, see the appropriate tariff.			
	DS0 Elec X-Conn (DS0 UNECC)	\$0.94	N/A
	DS1 Elec X-Conn (DS1 UNECC)	\$2.93	N/A
	DS3 Elec X-Conn (DS3 UNECC)	\$25.85	N/A
	DS1 Facility Cross Connect: 1/2 of a DS1 UNECC consisting of one DSX panel and high frequency cable.	\$1.47	N/A
<b>COMMON CHANNEL SIGNALING INTERCONNECTION SERVICE</b>			
	STP Port	\$422.40	\$308.00
	STP Switching	\$0.76	N/A
	STP Transport Link 56.0 Kpbs SS7 Link per month	IES Tariff	N/A
	STP Transport Link 56.0 Kpbs SS7 Link per mile	IES Tariff	N/A
	STP Transport Link 1.544 Mbps SS7 Link per month	IES Tariff	N/A
	STP Transport Link 1.544 Mbps SS7 Link per mile	IES Tariff	N/A
	Multiplexing DS1 to DS0	IES Tariff	\$300.00
	Originating Point Code (OPC)	IES Tariff	\$22.30
	GlobalTitle Address Translation (GTT)	IES Tariff	\$11.15
<b>LINE INFORMATION DATABASE</b>			
	LIDB Database Transport per query	IES Tariff	\$0.0016
	LIDB Database per query	IES Tariff	\$0.0366
	Toll Free Code Access Service query	IES Tariff	\$0.008822
	Toll Free Code Optional Service query	IES Tariff	\$0.001405



<b>DIRECTORY ASSISTANCE SERVICES</b>			
DA Database Listing & Update per listing or update		\$0.05	
DA Data Base Query Service per query		\$0.0100	
<b>TOLL &amp; LOCAL OPERATOR SERVICES</b>			
Toll and Local Assistance Service (Live)		\$0.414	
<b>DA OPERATOR SERVICE</b>			
DA Operator Service (Live)		\$0.353	
<b>911 TANDEM PORT</b>			
Per DSO Equivalent Port		\$15.81	\$187.50
<b>STREET INDEX GUIDE</b>			
Monthly Charge		\$41.00	
Tape Charge		\$50.00	
<b>OPERATIONAL SUPPORT SYSTEMS</b>			
OSS Interfaces		ICB	

Exchange	CLLI	Band	2 Wire Voice Grade Rate	4 Wire Voice Grade Rate	DS0 2 Wire Digital Data Loop or Interconne ction ADSL/ISDN -BRI	DS0 4 Wire Digital Data 56 or 64 kbps	DS1 4 Wire Digital Data DS1/T1/ISDN- PRI Loop or Interconnecti on
----------	------	------	----------------------------------	----------------------------------	---	--	--

Maitland XA	MTLDFLXA	1	\$ 10.78	\$ 18.80	\$ 11.65	\$ 20.30	\$ 64.49
Maitland TC	MTLDFLTC	1	\$ 10.78	\$ 18.80	\$ 11.65	\$ 20.30	\$ 64.49
Tallahassee - Calhoun	TLHSFLXA	1	\$ 10.78	\$ 18.80	\$ 11.65	\$ 20.30	\$ 64.49
Tallahassee - FSU	TLHSFLXE	1	\$ 10.78	\$ 18.80	\$ 11.65	\$ 20.30	\$ 64.49
Destin	DESTFLXA	1	\$ 10.78	\$ 18.80	\$ 11.65	\$ 20.30	\$ 64.49
South Fort Meyers	FTMYFLXC	1	\$ 10.78	\$ 18.80	\$ 11.65	\$ 20.30	\$ 64.49
Boca Grande	BCGRFLXA	1	\$ 10.78	\$ 18.80	\$ 11.65	\$ 20.30	\$ 64.49
Murdock	MRDCFLXA	1	\$ 10.78	\$ 18.80	\$ 11.65	\$ 20.30	\$ 64.49
Fort Myers	FTMYFLXA	1	\$ 10.78	\$ 18.80	\$ 11.65	\$ 20.30	\$ 64.49
Winter Park	WNPKFLXA	1	\$ 10.78	\$ 18.80	\$ 11.65	\$ 20.30	\$ 64.49
Fort Myers Beach	FTMBFLXA	1	\$ 10.78	\$ 18.80	\$ 11.65	\$ 20.30	\$ 64.49
Lake Brantley	LKBRFLXA	1	\$ 10.78	\$ 18.80	\$ 11.65	\$ 20.30	\$ 64.49
North Naples	NNPLFLXA	1	\$ 10.78	\$ 18.80	\$ 11.65	\$ 20.30	\$ 64.49
Naples Moorings	NPLSFLXD	1	\$ 10.78	\$ 18.80	\$ 11.65	\$ 20.30	\$ 64.49
Marco Island	MOISFLXA	2	\$ 15.41	\$ 26.88	\$ 16.65	\$ 29.03	\$ 74.96
Altamonte Springs	ALSPFLXA	2	\$ 15.41	\$ 26.88	\$ 16.65	\$ 29.03	\$ 74.96

Iona	IONAFLXA	2	\$ 15.41	\$ 26.88	\$ 16.65	\$ 29.03	\$ 74.96
Goldenrod	GLRDFLXA	2	\$ 15.41	\$ 26.88	\$ 16.65	\$ 29.03	\$ 74.96
Fort Walton Beach XB	FTWBFLXB	2	\$ 15.41	\$ 26.88	\$ 16.65	\$ 29.03	\$ 74.96
Fort Walton Beach XA	FTWBFLXA	2	\$ 15.41	\$ 26.88	\$ 16.65	\$ 29.03	\$ 74.96
Buenaventura Lakes	KSSMFLXD	2	\$ 15.41	\$ 26.88	\$ 16.65	\$ 29.03	\$ 74.96
Tallahassee - Willis	TLHSFLXB	2	\$ 15.41	\$ 26.88	\$ 16.65	\$ 29.03	\$ 74.96
Shalimar	SHLMFLXA	2	\$ 15.41	\$ 26.88	\$ 16.65	\$ 29.03	\$ 74.96
Cypress Lake XA	CYLKFLXA	2	\$ 15.41	\$ 26.88	\$ 16.65	\$ 29.03	\$ 74.96
Casselberry	CSLBFLXA	2	\$ 15.41	\$ 26.88	\$ 16.65	\$ 29.03	\$ 74.96
Fort Walton Beach XC	FTWBFLXC	2	\$ 15.41	\$ 26.88	\$ 16.65	\$ 29.03	\$ 74.96
Cypress Lake XB	CYLKFLXB	2	\$ 15.41	\$ 26.88	\$ 16.65	\$ 29.03	\$ 74.96
Orange City	ORCYFLXA	2	\$ 15.41	\$ 26.88	\$ 16.65	\$ 29.03	\$ 74.96
Ocala XJ	OCALFLXJ	2	\$ 15.41	\$ 26.88	\$ 16.65	\$ 29.03	\$ 74.96
North Fort Myers XA	NFMYFLXA	2	\$ 15.41	\$ 26.88	\$ 16.65	\$ 29.03	\$ 74.96
Cape Coral	CPCRFLXA	2	\$ 15.41	\$ 26.88	\$ 16.65	\$ 29.03	\$ 74.96
Bonita Springs	BNSPFLXA	2	\$ 15.41	\$ 26.88	\$ 16.65	\$ 29.03	\$ 74.96
Sanibel-Captiva Islands	SNISFLXA	2	\$ 15.41	\$ 26.88	\$ 16.65	\$ 29.03	\$ 74.96
West Kissimmee	KSSMFLXB	2	\$ 15.41	\$ 26.88	\$ 16.65	\$ 29.03	\$ 74.96
Kissimmee	KSSMFLXA	2	\$ 15.41	\$ 26.88	\$ 16.65	\$ 29.03	\$ 74.96
Windermere	WNDRFLXA	3	\$ 20.54	\$ 35.85	\$ 22.20	\$ 38.72	\$ 84.83
Highlands	OCALFLXC	3	\$ 20.54	\$ 35.85	\$ 22.20	\$ 38.72	\$ 84.83
Tallahassee - Perkins	TLHSFLXH	3	\$ 20.54	\$ 35.85	\$ 22.20	\$ 38.72	\$ 84.83
Eustis	ESTSFLXA	3	\$ 20.54	\$ 35.85	\$ 22.20	\$ 38.72	\$ 84.83
San Carlos Park	SCPKFLXA	3	\$ 20.54	\$ 35.85	\$ 22.20	\$ 38.72	\$ 84.83
North Cape Coral	CPCRFLXB	3	\$ 20.54	\$ 35.85	\$ 22.20	\$ 38.72	\$ 84.83
Tallahassee Blairstone	TLHSFLXD	3	\$ 20.54	\$ 35.85	\$ 22.20	\$ 38.72	\$ 84.83
Port Charlotte	PTCTFLXA	3	\$ 20.54	\$ 35.85	\$ 22.20	\$ 38.72	\$ 84.83
Golden Gate	GLGCFLXA	3	\$ 20.54	\$ 35.85	\$ 22.20	\$ 38.72	\$ 84.83
Tavares	TVRSFLXA	3	\$ 20.54	\$ 35.85	\$ 22.20	\$ 38.72	\$ 84.83
Apopka	APPKFLXA	3	\$ 20.54	\$ 35.85	\$ 22.20	\$ 38.72	\$ 84.83
Westville	WSTVFLXA	3	\$ 20.54	\$ 35.85	\$ 22.20	\$ 38.72	\$ 84.83
Ocala XA	OCALFLXA	3	\$ 20.54	\$ 35.85	\$ 22.20	\$ 38.72	\$ 84.83
Tallahassee - Mabry	TLHSFLXC	3	\$ 20.54	\$ 35.85	\$ 22.20	\$ 38.72	\$ 84.83
North Fort Myers XB	NFMYFLXB	3	\$ 20.54	\$ 35.85	\$ 22.20	\$ 38.72	\$ 84.83
Naples South East	NPLSFLXC	3	\$ 20.54	\$ 35.85	\$ 22.20	\$ 38.72	\$ 84.83
Winter Garden	WNGRFLXA	3	\$ 20.54	\$ 35.85	\$ 22.20	\$ 38.72	\$ 84.83
Leesburg	LSBGFLXA	3	\$ 20.54	\$ 35.85	\$ 22.20	\$ 38.72	\$ 84.83
Lady Lake (753)	LDLKFLXA	3	\$ 20.54	\$ 35.85	\$ 22.20	\$ 38.72	\$ 84.83
Deltona Lakes	ORCYFLXC	3	\$ 20.54	\$ 35.85	\$ 22.20	\$ 38.72	\$ 84.83
Sebring	SBNGFLXA	3	\$ 20.54	\$ 35.85	\$ 22.20	\$ 38.72	\$ 84.83
Shady Road	OCALFLXB	4	\$ 27.09	\$ 47.24	\$ 29.26	\$ 51.02	\$ 97.36
Silver Springs Shores	SVSSFLXA	4	\$ 27.09	\$ 47.24	\$ 29.26	\$ 51.02	\$ 97.36
Clermont	CLMTFLXA	4	\$ 27.09	\$ 47.24	\$ 29.26	\$ 51.02	\$ 97.36
Tallahassee Thomasville	TLHSFLXF	4	\$ 27.09	\$ 47.24	\$ 29.26	\$ 51.02	\$ 97.36
Lehigh Acres	LHACFLXA	4	\$ 27.09	\$ 47.24	\$ 29.26	\$ 51.02	\$ 97.36
East Fort Meyers	FTMYFLXB	4	\$ 27.09	\$ 47.24	\$ 29.26	\$ 51.02	\$ 97.36
Montverde	MTVRFLXA	4	\$ 27.09	\$ 47.24	\$ 29.26	\$ 51.02	\$ 97.36
Valparaiso/678	VLPRFLXA	4	\$ 27.09	\$ 47.24	\$ 29.26	\$ 51.02	\$ 97.36

Beverly Hills	BVHLFLXA	4	\$ 27.09	\$ 47.24	\$ 29.26	\$ 51.02	\$ 97.36
Cape Haze	CPHZFLXA	4	\$ 27.09	\$ 47.24	\$ 29.26	\$ 51.02	\$ 97.36
Dade City	DDCYFLXA	4	\$ 27.09	\$ 47.24	\$ 29.26	\$ 51.02	\$ 97.36
Punta Gorda	PNGRFLXA	4	\$ 27.09	\$ 47.24	\$ 29.26	\$ 51.02	\$ 97.36
Mount Dora	MTDRFLXA	4	\$ 27.09	\$ 47.24	\$ 29.26	\$ 51.02	\$ 97.36
Crestview	CRVWFLXA	4	\$ 27.09	\$ 47.24	\$ 29.26	\$ 51.02	\$ 97.36
Crystal River	CRRVFLXA	4	\$ 27.09	\$ 47.24	\$ 29.26	\$ 51.02	\$ 97.36
Lake Helen	LKHLFLXA	4	\$ 27.09	\$ 47.24	\$ 29.26	\$ 51.02	\$ 97.36
Clewiston	CLTNFLXA	4	\$ 27.09	\$ 47.24	\$ 29.26	\$ 51.02	\$ 97.36
Sea Grove Beach	SGBHFLXA	4	\$ 27.09	\$ 47.24	\$ 29.26	\$ 51.02	\$ 97.36
St. Cloud	STCDFLXA	4	\$ 27.09	\$ 47.24	\$ 29.26	\$ 51.02	\$ 97.36
Homosassa Spgs	HMSPLXA	4	\$ 27.09	\$ 47.24	\$ 29.26	\$ 51.02	\$ 97.36
Inverness	INVRFLXA	4	\$ 27.09	\$ 47.24	\$ 29.26	\$ 51.02	\$ 97.36
Oklawaha	OKLWFLXA	4	\$ 27.09	\$ 47.24	\$ 29.26	\$ 51.02	\$ 97.36
Madison	MDSNFLXA	4	\$ 27.09	\$ 47.24	\$ 29.26	\$ 51.02	\$ 97.36
Pine Island	PNISFLXA	4	\$ 27.09	\$ 47.24	\$ 29.26	\$ 51.02	\$ 97.36
Avon Park	AVPKFLXA	4	\$ 27.09	\$ 47.24	\$ 29.26	\$ 51.02	\$ 97.36
Silver Springs	SVSPFLXA	4	\$ 27.09	\$ 47.24	\$ 29.26	\$ 51.02	\$ 97.36

Belleview	BLVWFLXA	5	\$ 39.66	\$ 69.17	\$ 42.84	\$ 74.70	\$ 124.02
Chassohowitza	CHSWFLXA	5	\$ 39.66	\$ 69.17	\$ 42.84	\$ 74.70	\$ 124.02
Immokalee	IMKLFLXA	5	\$ 39.66	\$ 69.17	\$ 42.84	\$ 74.70	\$ 124.02
Wildwood	WLWDFLXA	5	\$ 39.66	\$ 69.17	\$ 42.84	\$ 74.70	\$ 124.02
Moore Heaven	MRHNFLXA	5	\$ 39.66	\$ 69.17	\$ 42.84	\$ 74.70	\$ 124.02
Arcadia	ARCDFLXA	5	\$ 39.66	\$ 69.17	\$ 42.84	\$ 74.70	\$ 124.02
Marianna	MRNNFLXA	5	\$ 39.66	\$ 69.17	\$ 42.84	\$ 74.70	\$ 124.02
Lake Placid	LKPCFLXA	5	\$ 39.66	\$ 69.17	\$ 42.84	\$ 74.70	\$ 124.02
Okeechobee	OKCBFLXA	5	\$ 39.66	\$ 69.17	\$ 42.84	\$ 74.70	\$ 124.02
Bushnell	BSHNFLXA	5	\$ 39.66	\$ 69.17	\$ 42.84	\$ 74.70	\$ 124.02
Santa Rosa Beach	SNRSFLXA	5	\$ 39.66	\$ 69.17	\$ 42.84	\$ 74.70	\$ 124.02
Alva	ALVAFLXA	5	\$ 39.66	\$ 69.17	\$ 42.84	\$ 74.70	\$ 124.02
Tallahassee XG	TLHSFLXG	5	\$ 39.66	\$ 69.17	\$ 42.84	\$ 74.70	\$ 124.02
Astor	ASTRFLXA	5	\$ 39.66	\$ 69.17	\$ 42.84	\$ 74.70	\$ 124.02
Spring Lake	SLHLFLXA	5	\$ 39.66	\$ 69.17	\$ 42.84	\$ 74.70	\$ 124.02
Wauchula	WCHLFLXA	5	\$ 39.66	\$ 69.17	\$ 42.84	\$ 74.70	\$ 124.02
Starke	STRKFLXA	5	\$ 39.66	\$ 69.17	\$ 42.84	\$ 74.70	\$ 124.02
San Antonio	SNANFLXA	5	\$ 39.66	\$ 69.17	\$ 42.84	\$ 74.70	\$ 124.02
Labelle	LBLFLXA	5	\$ 39.66	\$ 69.17	\$ 42.84	\$ 74.70	\$ 124.02
Groveland	GVLDFLXA	5	\$ 39.66	\$ 69.17	\$ 42.84	\$ 74.70	\$ 124.02
Bowling Green	BWLGFLXA	5	\$ 39.66	\$ 69.17	\$ 42.84	\$ 74.70	\$ 124.02
Fort Meade	FTMDFLXA	5	\$ 39.66	\$ 69.17	\$ 42.84	\$ 74.70	\$ 124.02
Howey-In-The-Hills	HOWYFLXA	5	\$ 39.66	\$ 69.17	\$ 42.84	\$ 74.70	\$ 124.02
Forest	OCNFFLXA	5	\$ 39.66	\$ 69.17	\$ 42.84	\$ 74.70	\$ 124.02
Trilacoochee	TLCHFLXA	5	\$ 39.66	\$ 69.17	\$ 42.84	\$ 74.70	\$ 124.02
Crawfordville	CFVLFLXA	5	\$ 39.66	\$ 69.17	\$ 42.84	\$ 74.70	\$ 124.02
Everglades	EVRGFLXA	5	\$ 39.66	\$ 69.17	\$ 42.84	\$ 74.70	\$ 124.02

Salt Springs	SSPRFLXA	6	\$ 74.05	\$ 129.13	\$ 79.98	\$ 139.46	\$ 194.40
DeFuniak Springs	DFSPFLXA	6	\$ 74.05	\$ 129.13	\$ 79.98	\$ 139.46	\$ 194.40
Umatilla	UMTLFLXA	6	\$ 74.05	\$ 129.13	\$ 79.98	\$ 139.46	\$ 194.40

Sneads	SNDSFLXA	6	\$	74.05	\$	129.13	\$	79.98	\$	139.46	\$	194.40
Williston	WLSTFLXA	6	\$	74.05	\$	129.13	\$	79.98	\$	139.46	\$	194.40
Grand Ridge	GDRGFLXA	6	\$	74.05	\$	129.13	\$	79.98	\$	139.46	\$	194.40
Zolfo Springs	ZLSPFLXA	6	\$	74.05	\$	129.13	\$	79.98	\$	139.46	\$	194.40
Monticello	MNTIFLXA	6	\$	74.05	\$	129.13	\$	79.98	\$	139.46	\$	194.40
St. Marks	STMKFLXA	6	\$	74.05	\$	129.13	\$	79.98	\$	139.46	\$	194.40
Freeport	FRPTFLXA	6	\$	74.05	\$	129.13	\$	79.98	\$	139.46	\$	194.40
Bonifay	BNFYFLXA	6	\$	74.05	\$	129.13	\$	79.98	\$	139.46	\$	194.40
Cottondale	CTDLFLXA	6	\$	74.05	\$	129.13	\$	79.98	\$	139.46	\$	194.40
Lawtey	LWTYFLXA	6	\$	74.05	\$	129.13	\$	79.98	\$	139.46	\$	194.40
Panacea	PANCFLXA	6	\$	74.05	\$	129.13	\$	79.98	\$	139.46	\$	194.40
Reynolds Hill	RYHLFLXA	6	\$	74.05	\$	129.13	\$	79.98	\$	139.46	\$	194.40
Sopchoppy	SPCPFLXA	6	\$	74.05	\$	129.13	\$	79.98	\$	139.46	\$	194.40
Malone	MALNFLXA	6	\$	74.05	\$	129.13	\$	79.98	\$	139.46	\$	194.40
Baker	BAKRFLXA	6	\$	74.05	\$	129.13	\$	79.98	\$	139.46	\$	194.40
Alford	ALFRFLXA	6	\$	74.05	\$	129.13	\$	79.98	\$	139.46	\$	194.40
Kingsley Lake	KGLKFLXA	6	\$	74.05	\$	129.13	\$	79.98	\$	139.46	\$	194.40
Greenville	GNVLFLXA	6	\$	74.05	\$	129.13	\$	79.98	\$	139.46	\$	194.40
Ponce de Leon	PNLNFLXA	6	\$	74.05	\$	129.13	\$	79.98	\$	139.46	\$	194.40
Kenansville	KNVLFLXA	6	\$	74.05	\$	129.13	\$	79.98	\$	139.46	\$	194.40
Lee	LEE FLXA	6	\$	74.05	\$	129.13	\$	79.98	\$	139.46	\$	194.40
Glendale	GLDLFLXA	6	\$	74.05	\$	129.13	\$	79.98	\$	139.46	\$	194.40
Cherry Lake	CHLKFLXA	6	\$	74.05	\$	129.13	\$	79.98	\$	139.46	\$	194.40
Greenwood	GNWDFLXA	6	\$	74.05	\$	129.13	\$	79.98	\$	139.46	\$	194.40

<b>Originating</b>	<b>Terminating</b>	<b>Dedicated DS1</b>	<b>Dedicated DS3</b>
ALFRFLXA	CTDLFLXA	\$ 86.39	\$ 1,178.36
ALFRFLXA	MRNNFLXA	\$ 149.76	\$ 2,356.73
ALSPFLXA	APPKFLXA	\$ 71.95	\$ 1,178.36
ALSPFLXA	CSLBFLXA	\$ 86.39	\$ 1,178.36
ALSPFLXA	CLBRFLAD	\$ 156.33	\$ 3,535.09
ALSPFLXA	EORNFLXA	\$ 114.14	\$ 2,356.73
ALSPFLXA	GENVFLXA	\$ 114.14	\$ 2,356.73
ALSPFLXA	GLRDFLXA	\$ 86.39	\$ 1,178.36
ALSPFLXA	LKBRFLXA	\$ 71.95	\$ 1,178.36
ALSPFLXA	LKBNFLXA	\$ 156.33	\$ 3,535.09
ALSPFLXA	MTLDFLXA	\$ 71.95	\$ 1,178.36
ALSPFLXA	MTVRFLXA	\$ 238.53	\$ 5,604.09
ALSPFLXA	ORLDFLXA	\$ 114.14	\$ 2,356.73
ALSPFLXA	OVIDFLCA	\$ 114.14	\$ 2,356.73
ALSPFLXA	KSSMFLXC	\$ 174.14	\$ 3,535.09
ALSPFLXA	SNFRFLMA	\$ 114.14	\$ 2,356.73
ALSPFLXA	WNRDFLXA	\$ 174.14	\$ 3,535.09
ALSPFLXA	WNGRFLXA	\$ 114.14	\$ 2,356.73
ALSPFLXA	WNPKFLXA	\$ 86.39	\$ 1,178.36

ALVAFLXA	BNSPFLXA	\$ 86.39	\$ 1,178.36
ALVAFLXA	CPCRFLXA	\$ 136.41	\$ 2,771.35
ALVAFLXA	FTMYFLXB	\$ 86.39	\$ 1,178.36
ALVAFLXA	RGAPFLXA	\$ 158.34	\$ 2,949.75
ALVAFLXA	FTMYFLXA	\$ 86.39	\$ 1,178.36
ALVAFLXA	FTMBFLXA	\$ 71.95	\$ 1,178.36
ALVAFLXA	LHACFLXA	\$ 86.39	\$ 1,178.36
ALVAFLXA	CPCRFLXB	\$ 136.41	\$ 2,771.35
ALVAFLXA	NFMYFLXA	\$ 136.41	\$ 2,771.35
ALVAFLXA	PNISFLXA	\$ 71.95	\$ 1,178.36
ALVAFLXA	SNISFLXA	\$ 71.95	\$ 1,178.36
ALVAFLXA	FTMYFLXC	\$ 86.39	\$ 1,178.36
APPKFLXA	CSLBFLXA	\$ 131.95	\$ 2,356.73
APPKFLXA	CLBRFLAD	\$ 114.14	\$ 2,356.73
APPKFLXA	EORNFLXA	\$ 114.14	\$ 2,356.73
APPKFLXA	GLRDFLXA	\$ 131.95	\$ 2,356.73
APPKFLXA	LKBRFLXA	\$ 71.95	\$ 1,178.36
APPKFLXA	LKBNFLXA	\$ 114.14	\$ 2,356.73
APPKFLXA	MTLDFLXA	\$ 71.95	\$ 1,178.36
APPKFLXA	MTVRFLXA	\$ 210.77	\$ 4,425.72
APPKFLXA	ORLDFLXA	\$ 114.14	\$ 2,356.73
APPKFLXA	KSSMFLXC	\$ 131.95	\$ 2,356.73
APPKFLXA	WNRDFLXA	\$ 131.95	\$ 2,356.73
APPKFLXA	WNGRFLXA	\$ 71.95	\$ 1,178.36
APPKFLXA	WNPKFLXA	\$ 71.95	\$ 1,178.36
ASTRFLXA	CLMTFLXA	\$ 202.19	\$ 4,425.72
ASTRFLXA	ESTSFLXA	\$ 202.19	\$ 4,425.72
ASTRFLXA	GVLDFLXA	\$ 318.00	\$ 7,080.06
ASTRFLXA	HOWYFLXA	\$ 326.58	\$ 7,673.08
ASTRFLXA	LDLKFLXA	\$ 265.56	\$ 6,197.11
ASTRFLXA	LSBGFLXA	\$ 202.19	\$ 4,425.72
ASTRFLXA	MTVRFLXA	\$ 326.58	\$ 7,673.08
ASTRFLXA	MTDRFLXA	\$ 202.19	\$ 4,425.72
ASTRFLXA	TVRSFLXA	\$ 202.19	\$ 4,425.72
ASTRFLXA	UMTLFLXA	\$ 138.82	\$ 3,247.36
BAKRFLXA	CRVWFLXA	\$ 124.39	\$ 3,247.36
BLVWFLXA	CITRFLXA	\$ 263.21	\$ 5,308.68
BLVWFLXA	DNLNFLXA	\$ 184.39	\$ 3,832.70
BLVWFLXA	OCNFFLXA	\$ 247.76	\$ 5,604.09
BLVWFLXA	OCALFLXC	\$ 131.95	\$ 2,356.73
BLVWFLXA	LDLKFLXB	\$ 86.39	\$ 1,771.38
BLVWFLXA	MCINFLXA	\$ 263.21	\$ 5,308.68
BLVWFLXA	OCALFLXA	\$ 138.82	\$ 2,654.34
BLVWFLXA	OKLWFLXA	\$ 71.95	\$ 1,178.36

BLWFLXA	ORSPFLXA	\$ 263.21	\$ 5,308.68
BLWFLXA	SSPRFLXA	\$ 454.53	\$ 11,117.08
BLWFLXA	SVSSFLXA	\$ 71.95	\$ 1,178.36
BVHLFLXA	CHSWFLXA	\$ 260.80	\$ 5,018.74
BVHLFLXA	CRRVFLXA	\$ 188.84	\$ 3,247.36
BVHLFLXA	HMSPFLEXA	\$ 188.84	\$ 3,247.36
BVHLFLXA	INVRFLXA	\$ 188.84	\$ 3,247.36
BNFYFLXA	RYHLFLXA	\$ 71.95	\$ 1,771.38
BNFYFLXA	WSTVFLXA	\$ 124.39	\$ 3,247.36
BNSPFLXA	CYLKFLXA	\$ 86.39	\$ 1,178.36
BNSPFLXA	FTMYFLXB	\$ 86.39	\$ 1,178.36
BNSPFLXA	FTMYFLXA	\$ 86.39	\$ 1,178.36
BNSPFLXA	FTMBFLXA	\$ 131.95	\$ 2,356.73
BNSPFLXA	GLGCFLXA	\$ 86.39	\$ 1,178.36
BNSPFLXA	NPLSFLXA	\$ 86.39	\$ 1,178.36
BNSPFLXA	NPLSFLXD	\$ 86.39	\$ 1,178.36
BNSPFLXA	NPLSFLXC	\$ 86.39	\$ 1,178.36
BNSPFLXA	NNPLFLXA	\$ 86.39	\$ 1,178.36
BWLGFLXA	WCHLFLXA	\$ 86.39	\$ 1,178.36
BWLGFLXA	ZLSPFLXA	\$ 124.39	\$ 2,654.34
KSSMFLXD	KSSMFLXA	\$ 71.95	\$ 1,771.38
BSHNFLXA	WLWDFLXA	\$ 202.19	\$ 4,425.72
CPCRFLXA	CYLKFLXA	\$ 136.41	\$ 2,771.35
CPCRFLXA	FTMYFLXB	\$ 136.41	\$ 2,771.35
CPCRFLXA	FTMYFLXA	\$ 136.41	\$ 2,771.35
CPCRFLXA	FTMBFLXA	\$ 174.82	\$ 3,949.71
CPCRFLXA	CPCRFLXB	\$ 136.41	\$ 2,771.35
CPCRFLXA	NFMYFLXA	\$ 136.41	\$ 2,771.35
CPCRFLXA	PNISFLXA	\$ 174.82	\$ 3,949.71
CPCRFLXA	SNISFLXA	\$ 174.82	\$ 3,949.71
CSLBFLXA	CLBRFLAD	\$ 174.14	\$ 3,535.09
CSLBFLXA	EORNFLXA	\$ 131.95	\$ 2,356.73
CSLBFLXA	GENVFLXA	\$ 131.95	\$ 2,356.73
CSLBFLXA	GLRDFLXA	\$ 86.39	\$ 1,178.36
CSLBFLXA	LKBRFLXA	\$ 131.95	\$ 2,356.73
CSLBFLXA	LKBNFLXA	\$ 174.14	\$ 3,535.09
CSLBFLXA	MTLDFLXA	\$ 131.95	\$ 2,356.73
CSLBFLXA	MTVRFLXA	\$ 256.34	\$ 5,604.09
CSLBFLXA	ORLDFLXA	\$ 131.95	\$ 2,356.73
CSLBFLXA	OVIDFLCA	\$ 131.95	\$ 2,356.73
CSLBFLXA	KSSMFLXC	\$ 191.95	\$ 3,535.09
CSLBFLXA	SNFRFLMA	\$ 131.95	\$ 2,356.73
CSLBFLXA	WNRDFLXA	\$ 191.95	\$ 3,535.09
CSLBFLXA	WNGRFLXA	\$ 131.95	\$ 2,356.73

CSLBFLXA	WNPKFLXA	\$ 86.39	\$ 1,178.36
CHSWFLXA	CRRVFLXA	\$ 260.80	\$ 5,018.74
CHSWFLXA	HMSPFLEXA	\$ 71.95	\$ 1,771.38
CHSWFLXA	INVRFLXA	\$ 260.80	\$ 5,018.74
CHLKFLXA	GNVFLXA	\$ 331.16	\$ 8,760.35
CHLKFLXA	LEE_FLXA	\$ 278.72	\$ 7,284.38
CHLKFLXA	MDSNFLXA	\$ 206.77	\$ 5,512.99
CLMTFLXA	CLBRFLAD	\$ 131.95	\$ 2,356.73
CLMTFLXA	ESTSFLXA	\$ 86.39	\$ 1,178.36
CLMTFLXA	GVLDFLXA	\$ 138.82	\$ 2,654.34
CLMTFLXA	HOWYFLXA	\$ 210.77	\$ 4,425.72
CLMTFLXA	LDLKFLXA	\$ 202.19	\$ 4,425.72
CLMTFLXA	LSBGFLXA	\$ 86.39	\$ 1,178.36
CLMTFLXA	LKBNFLXA	\$ 131.95	\$ 2,356.73
CLMTFLXA	MTVRFLXA	\$ 210.77	\$ 4,425.72
CLMTFLXA	MTDRFLXA	\$ 86.39	\$ 1,178.36
CLMTFLXA	ORLDFLXA	\$ 174.14	\$ 3,535.09
CLMTFLXA	KSSMFLXC	\$ 86.39	\$ 1,178.36
CLMTFLXA	TVRSFLXA	\$ 86.39	\$ 1,178.36
CLMTFLXA	UMTLFLXA	\$ 202.19	\$ 4,425.72
CLMTFLXA	WNRDFLXA	\$ 191.95	\$ 3,535.09
CLMTFLXA	WNGRFLXA	\$ 86.39	\$ 1,178.36
CTDLFLXA	MRNNFLXA	\$ 86.39	\$ 1,178.36
CFVLFLXA	ARPNFLXA *	\$ 504.27	\$ 11,821.63
CFVLFLXA	CRBLFLXA	\$ 504.27	\$ 11,821.63
CFVLFLXA	PNACFLXA	\$ 124.39	\$ 3,247.36
CFVLFLXA	SPCPFLXA	\$ 271.23	\$ 6,512.95
CFVLFLXA	STMKFLXA	\$ 124.39	\$ 3,247.36
CFVLFLXA	TLHSFLXD	\$ 271.23	\$ 6,512.95
CRWFLXA	LRHLFLXA *	\$ 71.95	\$ 1,178.36
CRRVFLXA	HMSPFLEXA	\$ 188.84	\$ 3,247.36
CRRVFLXA	INVRFLXA	\$ 188.84	\$ 3,247.36
CRRVFLXA	YNTWFLMA	\$ 227.25	\$ 4,425.72
CYLKFLXA	FTMYFLXB	\$ 86.39	\$ 1,178.36
CYLKFLXA	RGAPFLXA	\$ 71.95	\$ 1,771.38
CYLKFLXA	FTMYFLXA	\$ 86.39	\$ 1,178.36
CYLKFLXA	FTMBFLXA	\$ 71.95	\$ 1,178.36
CYLKFLXA	LHACFLXA	\$ 86.39	\$ 1,178.36
CYLKFLXA	CPCRFLXB	\$ 136.41	\$ 2,771.35
CYLKFLXA	NFMYFLXA	\$ 71.95	\$ 1,178.36
CYLKFLXA	PNISFLXA	\$ 71.95	\$ 1,178.36
CYLKFLXA	SNISFLXA	\$ 71.95	\$ 1,178.36
CYLKFLXA	FTMYFLXC	\$ 86.39	\$ 1,178.36
DDCYFLXA	SNANFLXA	\$ 86.39	\$ 1,178.36

DDCYFLXA	TLCHFLXA	\$ 86.39	\$ 1,178.36
DDCYFLXA	ZPHYFLXA	\$ 71.95	\$ 1,178.36
DFSPFLXA	FRPTFLXA	\$ 86.39	\$ 1,178.36
DFSPFLXA	GLDLFLXA	\$ 124.39	\$ 3,247.36
DFSPFLXA	PXTNFLXA *	\$ 131.95	\$ 2,356.73
DFSPFLXA	PNLNFLXA	\$ 124.39	\$ 3,247.36
ORCYFLXC	LKHNFLXA	\$ 71.95	\$ 1,771.38
ORCYFLXC	ORCYFLXA	\$ 71.95	\$ 1,771.38
DESTFLXA	FTWBFLXA	\$ 86.39	\$ 1,178.36
DESTFLXA	VLPRFLXA	\$ 86.39	\$ 1,178.36
DESTFLXA	SNRSFLXA	\$ 86.39	\$ 1,178.36
DESTFLXA	SHLMFLXA	\$ 86.39	\$ 1,178.36
DESTFLXA	VLPRFLXA	\$ 86.39	\$ 1,178.36
FTMYFLXB	RGAPFLXA	\$ 158.34	\$ 2,949.75
FTMYFLXB	FTMYFLXA	\$ 86.39	\$ 1,178.36
FTMYFLXB	FTMBFLXA	\$ 71.95	\$ 1,178.36
FTMYFLXB	LHACFLXA	\$ 86.39	\$ 1,178.36
FTMYFLXB	CPCRFLXB	\$ 136.41	\$ 2,771.35
FTMYFLXB	NFMYFLXA	\$ 136.41	\$ 2,771.35
FTMYFLXB	PNISFLXA	\$ 71.95	\$ 1,178.36
FTMYFLXB	SNISFLXA	\$ 71.95	\$ 1,178.36
FTMYFLXB	FTMYFLXC	\$ 86.39	\$ 1,178.36
ESTSFLXA	GVLDFLXA	\$ 202.19	\$ 3,832.70
ESTSFLXA	HOWYFLXA	\$ 210.77	\$ 4,425.72
ESTSFLXA	LDLKFLXA	\$ 149.76	\$ 2,949.75
ESTSFLXA	LSBGFLXA	\$ 86.39	\$ 1,178.36
ESTSFLXA	MTVRFLXA	\$ 210.77	\$ 4,425.72
ESTSFLXA	MTDRFLXA	\$ 86.39	\$ 1,178.36
ESTSFLXA	TVRSFLXA	\$ 86.39	\$ 1,178.36
ESTSFLXA	UMTLFLXA	\$ 86.39	\$ 1,178.36
OCNFFLXA	CITRFLXA	\$ 326.58	\$ 7,080.06
OCNFFLXA	DNLNFLXA	\$ 363.56	\$ 8,258.42
OCNFFLXA	OCALFLXC	\$ 138.82	\$ 3,247.36
OCNFFLXA	LDLKFLXB	\$ 307.76	\$ 7,375.47
OCNFFLXA	MCINFLXA	\$ 326.58	\$ 7,080.06
OCNFFLXA	OCALFLXA	\$ 202.19	\$ 4,425.72
OCNFFLXA	OKLWFLXA	\$ 247.76	\$ 5,604.09
OCNFFLXA	ORSPFLXA	\$ 326.58	\$ 7,080.06
OCNFFLXA	SSPRFLXA	\$ 345.60	\$ 8,760.35
OCNFFLXA	SVSSFLXA	\$ 247.76	\$ 5,604.09
FTMDFLXA	BARTFLXA	\$ 71.95	\$ 1,178.36
FTMDFLXA	LKLDLFLXA	\$ 71.95	\$ 1,178.36
RGAPFLXA	FTMYFLXC	\$ 158.34	\$ 2,949.75
FTMYFLXA	FTMBFLXA	\$ 71.95	\$ 1,178.36



FTMYFLXA	LHACFLXA	\$ 86.39	\$ 1,178.36
FTMYFLXA	CPCRFLXB	\$ 136.41	\$ 2,771.35
FTMYFLXA	NFMYFLXA	\$ 136.41	\$ 2,771.35
FTMYFLXA	PNISFLXA	\$ 71.95	\$ 1,178.36
FTMYFLXA	SNISFLXA	\$ 71.95	\$ 1,178.36
FTMBFLXA	LHACFLXA	\$ 131.95	\$ 2,356.73
FTMBFLXA	CPCRFLXB	\$ 174.82	\$ 3,949.71
FTMBFLXA	NFMYFLXA	\$ 71.95	\$ 1,178.36
FTMBFLXA	PNISFLXA	\$ 71.95	\$ 1,178.36
FTMBFLXA	SNISFLXA	\$ 71.95	\$ 1,178.36
FTWBFLXA	HLNVFLMA *	\$ 71.95	\$ 1,178.36
FTWBFLXA	VLPRFLXA	\$ 86.39	\$ 1,178.36
FTWBFLXA	SNRSFLXA	\$ 149.76	\$ 2,356.73
FTWBFLXA	SHLMFLXA	\$ 86.39	\$ 1,178.36
FTWBFLXA	VLPRFLXA	\$ 86.39	\$ 1,178.36
GLGCFLXA	MOISFLXA	\$ 86.39	\$ 1,178.36
GLGCFLXA	NPLSFLXA	\$ 86.39	\$ 1,178.36
GLGCFLXA	NPLSFLXD	\$ 86.39	\$ 1,178.36
GLGCFLXA	NPLSFLXC	\$ 86.39	\$ 1,178.36
GLGCFLXA	NNPLFLXA	\$ 86.39	\$ 1,178.36
GLRDFLXA	CLBRFLAD	\$ 174.14	\$ 3,535.09
GLRDFLXA	EORNFLXA	\$ 131.95	\$ 2,356.73
GLRDFLXA	GENVFLXA	\$ 131.95	\$ 2,356.73
GLRDFLXA	LKBRFLXA	\$ 131.95	\$ 2,356.73
GLRDFLXA	LKBNFLXA	\$ 174.14	\$ 3,535.09
GLRDFLXA	MTLDLXA	\$ 131.95	\$ 2,356.73
GLRDFLXA	MTVRFLXA	\$ 256.34	\$ 5,604.09
GLRDFLXA	ORLDFLXA	\$ 131.95	\$ 2,356.73
GLRDFLXA	OVDFLCA	\$ 131.95	\$ 2,356.73
GLRDFLXA	KSSMFLXC	\$ 191.95	\$ 3,535.09
GLRDFLXA	SNFRFLMA	\$ 131.95	\$ 2,356.73
GLRDFLXA	WNDRFLXA	\$ 191.95	\$ 3,535.09
GLRDFLXA	WNGRFLXA	\$ 131.95	\$ 2,356.73
GLRDFLXA	WNPKFLXA	\$ 86.39	\$ 1,178.36
GDRGFLXA	MRNNFLXA	\$ 86.39	\$ 1,178.36
GDRGFLXA	SNDSFLXA	\$ 86.39	\$ 1,178.36
GNVFLXA	LEE_FLXA	\$ 196.34	\$ 5,018.74
GNVFLXA	MDSNFLXA	\$ 124.39	\$ 3,247.36
GNVFLXA	MNTIFLXA	\$ 138.82	\$ 2,654.34
GNVFLXA	TLHSFLXA	\$ 138.82	\$ 2,654.34
GNWDFLXA	MALNFLXA	\$ 86.39	\$ 1,178.36
GNWDFLXA	MRNNFLXA	\$ 86.39	\$ 1,178.36
GVLDLXA	HOWYFLXA	\$ 263.21	\$ 5,901.70
GVLDLXA	LDLKFLXA	\$ 202.19	\$ 4,425.72

GVLDFLXA	LSBGFLXA	\$ 138.82	\$ 2,654.34
GVLDFLXA	MTVRFLXA	\$ 326.58	\$ 7,080.06
GVLDFLXA	MTDRFLXA	\$ 202.19	\$ 3,832.70
GVLDFLXA	TVRSFLXA	\$ 202.19	\$ 3,832.70
GVLDFLXA	UMTLFLXA	\$ 318.00	\$ 7,080.06
OCALFLXC	CITRFLXA	\$ 210.77	\$ 3,832.70
OCALFLXC	DNLNFLXA	\$ 247.76	\$ 5,011.07
OCALFLXC	LDLKFLXB	\$ 149.76	\$ 2,949.75
OCALFLXC	MCINFLXA	\$ 210.77	\$ 3,832.70
OCALFLXC	OCALFLXA	\$ 86.39	\$ 1,178.36
OCALFLXC	OKLWFLXA	\$ 131.95	\$ 2,356.73
OCALFLXC	ORSPFLXA	\$ 210.77	\$ 3,832.70
OCALFLXC	SSPRFLXA	\$ 408.97	\$ 9,938.72
OCALFLXC	OCALFLXB	\$ 138.82	\$ 2,654.34
OCALFLXC	SVSPFLXA	\$ 71.95	\$ 1,771.38
OCALFLXC	SVSSFLXA	\$ 131.95	\$ 2,356.73
HMSPFLXA	INVRFLXA	\$ 188.84	\$ 3,247.36
HOWYFLXA	LDLKFLXA	\$ 210.77	\$ 5,018.74
HOWYFLXA	LSBGFLXA	\$ 210.77	\$ 4,425.72
HOWYFLXA	MTVRFLXA	\$ 335.16	\$ 7,673.08
HOWYFLXA	MTDRFLXA	\$ 210.77	\$ 4,425.72
HOWYFLXA	TVRSFLXA	\$ 210.77	\$ 4,425.72
HOWYFLXA	UMTLFLXA	\$ 326.58	\$ 7,673.08
KNVFLXA	KSSMFLXA	\$ 138.82	\$ 2,654.34
KNVFLXA	STCDFLXA	\$ 138.82	\$ 2,654.34
KNVFLXA	KSSMFLXB	\$ 184.39	\$ 3,832.70
KGLKFLXA	LWTYFLXA	\$ 206.77	\$ 5,512.99
KGLKFLXA	RAFRFLAB	\$ 278.72	\$ 6,691.36
KGLKFLXA	STRKFLXA	\$ 206.77	\$ 5,512.99
KSSMFLXA	CLBRFLAD	\$ 114.14	\$ 2,356.73
KSSMFLXA	HNCYFLXA	\$ 138.82	\$ 2,654.34
KSSMFLXA	STCDFLXA	\$ 138.82	\$ 2,654.34
KSSMFLXA	KSSMFLXB	\$ 71.95	\$ 1,178.36
LDLKFLXA	LSBGFLXA	\$ 86.39	\$ 1,771.38
LDLKFLXA	MTVRFLXA	\$ 274.14	\$ 6,197.11
LDLKFLXA	MTDRFLXA	\$ 149.76	\$ 2,949.75
LDLKFLXA	TVRSFLXA	\$ 149.76	\$ 2,949.75
LDLKFLXA	UMTLFLXA	\$ 265.56	\$ 6,197.11
LDLKFLXB	LSBGFLXA	\$ 86.39	\$ 1,771.38
LDLKFLXB	MTVRFLXA	\$ 274.14	\$ 6,197.11
LDLKFLXB	MTDRFLXA	\$ 149.76	\$ 2,949.75
LDLKFLXB	OCALFLXA	\$ 202.19	\$ 4,425.72
LDLKFLXB	OKLWFLXA	\$ 131.95	\$ 2,949.75
LDLKFLXB	SSPRFLXA	\$ 514.53	\$ 12,888.46

LDLKFLXB	SVSSFLXA	\$ 131.95	\$ 2,949.75
LDLKFLXB	TVRSFLXA	\$ 149.76	\$ 2,949.75
LDLKFLXB	UMTLFLXA	\$ 265.56	\$ 6,197.11
LKBRFLXA	CLBRFLAD	\$ 156.33	\$ 3,535.09
LKBRFLXA	EORNFLXA	\$ 114.14	\$ 2,356.73
LKBRFLXA	GENVFLXA	\$ 114.14	\$ 2,356.73
LKBRFLXA	LKBNFLXA	\$ 156.33	\$ 3,535.09
LKBRFLXA	MTLDFLXA	\$ 71.95	\$ 1,178.36
LKBRFLXA	MTVRFLXA	\$ 238.53	\$ 5,604.09
LKBRFLXA	ORLDFLXA	\$ 114.14	\$ 2,356.73
LKBRFLXA	OVIDFLCA	\$ 114.14	\$ 2,356.73
LKBRFLXA	KSSMFLXC	\$ 174.14	\$ 3,535.09
LKBRFLXA	SNFRFLMA	\$ 114.14	\$ 2,356.73
LKBRFLXA	WNDRFLXA	\$ 174.14	\$ 3,535.09
LKBRFLXA	WNGRFLXA	\$ 114.14	\$ 2,356.73
LKBRFLXA	WNPKFLXA	\$ 71.95	\$ 1,178.36
LKHNFLXA	ORCYFLXA	\$ 71.95	\$ 1,771.38
LWTYFLXA	RAFRLAB	\$ 278.72	\$ 6,691.36
LWTYFLXA	STRKFLXA	\$ 206.77	\$ 5,512.99
LEE_FLXA	MDSNFLXA	\$ 71.95	\$ 1,771.38
LSBGFLXA	MTVRFLXA	\$ 210.77	\$ 4,425.72
LSBGFLXA	MTDRFLXA	\$ 86.39	\$ 1,178.36
LSBGFLXA	TVRSFLXA	\$ 86.39	\$ 1,178.36
LSBGFLXA	UMTLFLXA	\$ 202.19	\$ 4,425.72
MTLDFLXA	CLBRFLAD	\$ 156.33	\$ 3,535.09
MTLDFLXA	EORNFLXA	\$ 114.14	\$ 2,356.73
MTLDFLXA	GENVFLXA	\$ 114.14	\$ 2,356.73
MTLDFLXA	LKBNFLXA	\$ 156.33	\$ 3,535.09
MTLDFLXA	MTVRFLXA	\$ 238.53	\$ 5,604.09
MTLDFLXA	ORLDFLXA	\$ 114.14	\$ 2,356.73
MTLDFLXA	OVIDFLCA	\$ 114.14	\$ 2,356.73
MTLDFLXA	KSSMFLXC	\$ 174.14	\$ 3,535.09
MTLDFLXA	SNFRFLMA	\$ 114.14	\$ 2,356.73
MTLDFLXA	WNDRFLXA	\$ 174.14	\$ 3,535.09
MTLDFLXA	WNGRFLXA	\$ 114.14	\$ 2,356.73
MTLDFLXA	WNPKFLXA	\$ 71.95	\$ 1,178.36
MALNFLXA	MRNNFLXA	\$ 86.39	\$ 1,178.36
MOISFLXA	NPLSFLXA	\$ 86.39	\$ 1,178.36
MOISFLXA	NPLSFLXD	\$ 86.39	\$ 1,178.36
MOISFLXA	NPLSFLXC	\$ 86.39	\$ 1,178.36
MOISFLXA	NNPLFLXA	\$ 86.39	\$ 1,178.36
MRNNFLXA	ALTHFLXA	\$ 71.95	\$ 1,178.36
MRNNFLXA	SNDSFLXA	\$ 86.39	\$ 1,178.36
MNTIFLXA	TLHSFLXA	\$ 138.82	\$ 2,654.34

MTVRFLXA	CLBRFLAD	\$ 256.34	\$ 5,604.09
MTVRFLXA	EORNFLXA	\$ 238.53	\$ 5,604.09
MTVRFLXA	LKBNFLXA	\$ 256.34	\$ 5,604.09
MTVRFLXA	MTDRFLXA	\$ 210.77	\$ 4,425.72
MTVRFLXA	ORLDFLXA	\$ 238.53	\$ 5,604.09
MTVRFLXA	KSSMFLXC	\$ 210.77	\$ 4,425.72
MTVRFLXA	TVRSFLXA	\$ 210.77	\$ 4,425.72
MTVRFLXA	UMTLFLXA	\$ 210.77	\$ 4,425.72
MTVRFLXA	WNDRFLXA	\$ 210.77	\$ 4,425.72
MTVRFLXA	WNGRFLXA	\$ 124.39	\$ 3,247.36
MTVRFLXA	WNPKFLXA	\$ 196.34	\$ 4,425.72
MTDRFLXA	TVRSFLXA	\$ 86.39	\$ 1,178.36
MTDRFLXA	UMTLFLXA	\$ 202.19	\$ 4,425.72
NPLSFLXA	NPLSFLXC	\$ 86.39	\$ 1,178.36
NPLSFLXA	NNPLFLXA	\$ 86.39	\$ 1,178.36
NPLSFLXD	NPLSFLXC	\$ 86.39	\$ 1,178.36
NPLSFLXD	NNPLFLXA	\$ 86.39	\$ 1,178.36
NPLSFLXC	NNPLFLXA	\$ 86.39	\$ 1,178.36
VLPRFLXA	SHLMFLXA	\$ 86.39	\$ 1,178.36
CPCRFLXB	NFMYFLXA	\$ 136.41	\$ 2,771.35
CPCRFLXB	PNISFLXA	\$ 174.82	\$ 3,949.71
CPCRFLXB	SNISFLXA	\$ 174.82	\$ 3,949.71
NFMYFLXA	PNISFLXA	\$ 71.95	\$ 1,178.36
NFMYFLXA	SNISFLXA	\$ 71.95	\$ 1,178.36
OCALFLXA	CITRFLXA	\$ 263.21	\$ 5,308.68
OCALFLXA	DNLNFLXA	\$ 184.39	\$ 3,832.70
OCALFLXA	MCINFLXA	\$ 263.21	\$ 5,308.68
OCALFLXA	OKLWFLXA	\$ 71.95	\$ 1,178.36
OCALFLXA	ORSPFLXA	\$ 263.21	\$ 5,308.68
OCALFLXA	SSPRFLXA	\$ 408.97	\$ 9,938.72
OCALFLXA	OCALFLXB	\$ 138.82	\$ 2,654.34
OCALFLXA	SVSPFLXA	\$ 158.34	\$ 2,949.75
OCALFLXA	SVSSFLXA	\$ 71.95	\$ 1,178.36
OKLWFLXA	CITRFLXA	\$ 196.34	\$ 3,832.70
OKLWFLXA	DNLNFLXA	\$ 229.95	\$ 5,011.07
OKLWFLXA	MCINFLXA	\$ 196.34	\$ 3,832.70
OKLWFLXA	ORSPFLXA	\$ 196.34	\$ 3,832.70
OKLWFLXA	SSPRFLXA	\$ 454.53	\$ 11,117.08
OKLWFLXA	SVSSFLXA	\$ 71.95	\$ 1,178.36
ORCYFLXA	DBRYFLXA	\$ 71.95	\$ 1,178.36
ORCYFLXA	DELDFLXA	\$ 71.95	\$ 1,178.36
ORCYFLXA	DLSPFLXA	\$ 71.95	\$ 1,178.36
PNACFLXA	ARNPFLXA *	\$ 628.66	\$ 15,068.99
PNACFLXA	SPCPFLXA	\$ 395.62	\$ 9,760.31

PNACFLXA	STMKFLXA	\$ 248.78	\$ 6,494.72
PNACFLXA	TLHSFLXD	\$ 395.62	\$ 9,760.31
PNISFLXA	SNISFLXA	\$ 71.95	\$ 1,178.36
KSSMFLXC	CLBRFLAD	\$ 131.95	\$ 2,356.73
KSSMFLXC	EORNFLXA	\$ 174.14	\$ 3,535.09
KSSMFLXC	LKBNFLXA	\$ 131.95	\$ 2,356.73
KSSMFLXC	ORLDFLXA	\$ 174.14	\$ 3,535.09
KSSMFLXC	KSSMFLXB	\$ 86.39	\$ 1,178.36
KSSMFLXC	WNDRFLXA	\$ 149.76	\$ 2,356.73
KSSMFLXC	WNGRFLXA	\$ 86.39	\$ 1,178.36
KSSMFLXC	WNPKFLXA	\$ 131.95	\$ 2,356.73
RYHLFLXA	WSTVFLXA	\$ 196.34	\$ 5,018.74
SSPRFLXA	CITRFLXA	\$ 533.35	\$ 12,593.05
SSPRFLXA	DNLNFLXA	\$ 570.34	\$ 13,771.42
SSPRFLXA	MCINFLXA	\$ 533.35	\$ 12,593.05
SSPRFLXA	ORSPFLXA	\$ 533.35	\$ 12,593.05
SSPRFLXA	SVSSFLXA	\$ 454.53	\$ 11,117.08
SNANFLXA	TLCHFLXA	\$ 149.76	\$ 2,356.73
SNANFLXA	ZPHYFLXA	\$ 131.95	\$ 2,356.73
SNRSFLXA	SGBHFLXA	\$ 86.39	\$ 1,178.36
SBNGFLXA	SLHLFLXA	\$ 124.39	\$ 2,654.34
SHLMFLXA	VLPRFLXA	\$ 86.39	\$ 1,178.36
SVSSFLXA	CITRFLXA	\$ 196.34	\$ 3,832.70
SVSSFLXA	DNLNFLXA	\$ 229.95	\$ 5,011.07
SVSSFLXA	MCINFLXA	\$ 196.34	\$ 3,832.70
SVSSFLXA	ORSPFLXA	\$ 196.34	\$ 3,832.70
SPCPFLXA	ARNPFLXA *	\$ 504.27	\$ 11,821.63
SPCPFLXA	CRBLFLXA	\$ 504.27	\$ 11,821.63
SPCPFLXA	STMKFLXA	\$ 395.62	\$ 9,760.31
SPCPFLXA	TLHSFLXD	\$ 271.23	\$ 6,512.95
STCDFLXA	CLBRFLAD	\$ 114.14	\$ 2,356.73
STCDFLXA	KSSMFLXB	\$ 71.95	\$ 1,178.36
STMKFLXA	ARNPFLXA *	\$ 628.66	\$ 15,068.99
STMKFLXA	TLHSFLXD	\$ 395.62	\$ 9,760.31
STRKFLXA	KYHGFLMA *	\$ 278.72	\$ 6,691.36
STRKFLXA	RAFRFLAB	\$ 278.72	\$ 6,691.36
TLHSFLXA	ARNPFLXA *	\$ 263.21	\$ 5,308.68
TLHSFLXA	BRSTFLXA	\$ 131.95	\$ 2,356.73
TLHSFLXA	CRBLFLXA	\$ 263.21	\$ 5,308.68
TLHSFLXA	CHTHFLXA	\$ 263.21	\$ 5,308.68
TLHSFLXA	GNBOFLXA	\$ 131.95	\$ 2,356.73
TLHSFLXA	GRETFLXA	\$ 131.95	\$ 2,356.73
TLHSFLXA	HAVNFLMA	\$ 131.95	\$ 2,356.73
TLHSFLXA	HSFRFLXA *	\$ 131.95	\$ 2,356.73

TLHSFLXA	PRRYFLXA*	\$ 263.21	\$ 5,308.68
TLHSFLXA	QNCYFLXA	\$ 131.95	\$ 2,356.73
TLHSFLXA	TLHSFLXE	\$ 86.39	\$ 1,178.36
TLHSFLXA	TLHSFLXC	\$ 86.39	\$ 1,178.36
TLHSFLXA	TLHSFLXH	\$ 86.39	\$ 1,178.36
TLHSFLXA	TLHSFLXB	\$ 86.39	\$ 1,178.36
TLHSFLXA	TLHSFLXF	\$ 149.76	\$ 2,356.73
TLHSFLXE	ARNFLXA *	\$ 326.58	\$ 6,487.04
TLHSFLXE	BRSTFLXA	\$ 131.95	\$ 2,356.73
TLHSFLXE	CRBLFLXA	\$ 326.58	\$ 6,487.04
TLHSFLXE	CHTHFLXA	\$ 326.58	\$ 6,487.04
TLHSFLXE	GNBOFLXA	\$ 131.95	\$ 2,356.73
TLHSFLXE	GRETFLXA	\$ 131.95	\$ 2,356.73
TLHSFLXE	HAVNFLMA	\$ 131.95	\$ 2,356.73
TLHSFLXE	HSFRFLXA *	\$ 131.95	\$ 2,356.73
TLHSFLXE	QNCYFLXA	\$ 131.95	\$ 2,356.73
TLHSFLXE	TLHSFLXC	\$ 86.39	\$ 1,178.36
TLHSFLXE	TLHSFLXH	\$ 86.39	\$ 1,178.36
TLHSFLXE	TLHSFLXB	\$ 86.39	\$ 1,178.36
TLHSFLXE	TLHSFLXF	\$ 149.76	\$ 2,356.73
TLHSFLXC	ARNFLXA *	\$ 326.58	\$ 6,487.04
TLHSFLXC	BRSTFLXA	\$ 131.95	\$ 2,356.73
TLHSFLXC	CRBLFLXA	\$ 326.58	\$ 6,487.04
TLHSFLXC	CHTHFLXA	\$ 326.58	\$ 6,487.04
TLHSFLXC	GNBOFLXA	\$ 131.95	\$ 2,356.73
TLHSFLXC	GRETFLXA	\$ 131.95	\$ 2,356.73
TLHSFLXC	HAVNFLMA	\$ 131.95	\$ 2,356.73
TLHSFLXC	HSFRFLXA *	\$ 131.95	\$ 2,356.73
TLHSFLXC	QNCYFLXA	\$ 131.95	\$ 2,356.73
TLHSFLXC	TLHSFLXH	\$ 86.39	\$ 1,178.36
TLHSFLXC	TLHSFLXB	\$ 86.39	\$ 1,178.36
TLHSFLXC	TLHSFLXF	\$ 149.76	\$ 2,356.73
TLHSFLXH	ARNFLXA *	\$ 326.58	\$ 6,487.04
TLHSFLXH	BRSTFLXA	\$ 131.95	\$ 2,356.73
TLHSFLXH	CRBLFLXA	\$ 326.58	\$ 6,487.04
TLHSFLXH	CHTHFLXA	\$ 326.58	\$ 6,487.04
TLHSFLXH	GNBOFLXA	\$ 131.95	\$ 2,356.73
TLHSFLXH	GRETFLXA	\$ 131.95	\$ 2,356.73
TLHSFLXH	HAVNFLMA	\$ 131.95	\$ 2,356.73
TLHSFLXH	HSFRFLXA *	\$ 131.95	\$ 2,356.73
TLHSFLXH	QNCYFLXA	\$ 131.95	\$ 2,356.73
TLHSFLXH	TLHSFLXB	\$ 86.39	\$ 1,178.36
TLHSFLXH	TLHSFLXF	\$ 149.76	\$ 2,356.73
TLHSFLXB	ARNFLXA *	\$ 326.58	\$ 6,487.04

TLHSFLXB	BRSTFLXA	\$ 71.95	\$ 1,178.36
TLHSFLXB	CRBLFLXA	\$ 326.58	\$ 6,487.04
TLHSFLXB	CHTHFLXA	\$ 326.58	\$ 6,487.04
TLHSFLXB	GNBOFLXA	\$ 71.95	\$ 1,178.36
TLHSFLXB	GRETFLXA	\$ 71.95	\$ 1,178.36
TLHSFLXB	HAVNFLMA	\$ 71.95	\$ 1,178.36
TLHSFLXB	HSFRFLXA *	\$ 71.95	\$ 1,178.36
TLHSFLXB	QNCYFLXA	\$ 71.95	\$ 1,178.36
TLHSFLXD	ARNPFLXA *	\$ 326.58	\$ 6,487.04
TLHSFLXD	BRSTFLXA	\$ 131.95	\$ 2,356.73
TLHSFLXD	CRBLFLXA	\$ 326.58	\$ 6,487.04
TLHSFLXD	CHTHFLXA	\$ 326.58	\$ 6,487.04
TLHSFLXD	GNBOFLXA	\$ 131.95	\$ 2,356.73
TLHSFLXD	GRETFLXA	\$ 131.95	\$ 2,356.73
TLHSFLXD	HAVNFLMA	\$ 131.95	\$ 2,356.73
TLHSFLXD	HSFRFLXA *	\$ 131.95	\$ 2,356.73
TLHSFLXD	QNCYFLXA	\$ 131.95	\$ 2,356.73
TLHSFLXD	TLHSFLXA	\$ 86.39	\$ 1,178.36
TLHSFLXD	TLHSFLXE	\$ 149.76	\$ 2,356.73
TLHSFLXD	TLHSFLXC	\$ 86.39	\$ 1,178.36
TLHSFLXD	TLHSFLXH	\$ 149.76	\$ 2,356.73
TLHSFLXD	TLHSFLXB	\$ 86.39	\$ 1,178.36
TLHSFLXD	TLHSFLXF	\$ 149.76	\$ 2,356.73
TLHSFLXF	ARNPFLXA *	\$ 389.95	\$ 7,665.40
TLHSFLXF	BRSTFLXA	\$ 131.95	\$ 2,356.73
TLHSFLXF	CRBLFLXA	\$ 389.95	\$ 7,665.40
TLHSFLXF	CHTHFLXA	\$ 389.95	\$ 7,665.40
TLHSFLXF	GNBOFLXA	\$ 131.95	\$ 2,356.73
TLHSFLXF	GRETFLXA	\$ 131.95	\$ 2,356.73
TLHSFLXF	HAVNFLMA	\$ 131.95	\$ 2,356.73
TLHSFLXF	HSFRFLXA *	\$ 131.95	\$ 2,356.73
TLHSFLXF	QNCYFLXA	\$ 131.95	\$ 2,356.73
TLHSFLXF	TLHSFLXB	\$ 86.39	\$ 1,178.36
TVRSFLXA	UMTLFLXA	\$ 202.19	\$ 4,425.72
TLCHFLXA	ZPHYFLXA	\$ 131.95	\$ 2,356.73
WCHLFLXA	ZLSPFLXA	\$ 124.39	\$ 2,654.34
KSSMFLXB	CLBRFLAD	\$ 71.95	\$ 1,178.36
KSSMFLXB	HNCYFLXA	\$ 184.39	\$ 3,832.70
WLSTFLXA	BRSNFLMA	\$ 71.95	\$ 1,178.36
WDRFLXA	CLBRFLAD	\$ 174.14	\$ 3,535.09
WDRFLXA	EORNFLXA	\$ 174.14	\$ 3,535.09
WDRFLXA	LKBNFLXA	\$ 174.14	\$ 3,535.09
WDRFLXA	ORLDFLXA	\$ 174.14	\$ 3,535.09
WDRFLXA	WNGRFLXA	\$ 86.39	\$ 1,178.36

WDRFLXA	WPKFLXA	\$ 131.95	\$ 2,356.73
WGRFLXA	CLBRFLAD	\$ 131.95	\$ 2,356.73
WGRFLXA	EORNFLXA	\$ 114.14	\$ 2,356.73
WGRFLXA	LKBNFLXA	\$ 131.95	\$ 2,356.73
WGRFLXA	ORLDFLXA	\$ 114.14	\$ 2,356.73
WGRFLXA	WPKFLXA	\$ 71.95	\$ 1,178.36
WPKFLXA	CLBRFLAD	\$ 114.14	\$ 2,356.73
WPKFLXA	EORNFLXA	\$ 71.95	\$ 1,178.36
WPKFLXA	GENVFLXA	\$ 71.95	\$ 1,178.36
WPKFLXA	LKBNFLXA	\$ 114.14	\$ 2,356.73
WPKFLXA	ORLDFLXA	\$ 71.95	\$ 1,178.36
WPKFLXA	OVIDFLCA	\$ 71.95	\$ 1,178.36
WPKFLXA	SNFRFLMA	\$ 71.95	\$ 1,178.36



**ATTACHMENT II**  
**LOCAL RESALE**

**1. TELECOMMUNICATIONS SERVICES PROVIDED FOR RESALE**

- 1.1. At the request of Covad, and pursuant to the requirements of the Act, and FCC and Commission Rules and Regulations, Sprint shall make available to Covad for resale Telecommunications Services that Sprint currently provides or may provide hereafter at retail to subscribers who are not telecommunications carriers. Such resale may be as allowed by the FCC and Commission. The Telecommunications Services provided by Sprint to Covad pursuant to this Attachment II are collectively referred to as "Local Resale."
- 1.2. To the extent that this Attachment describes services which Sprint shall make available to Covad for resale pursuant to this Agreement, this list of services is neither all inclusive nor exclusive.

**2. GENERAL TERMS AND CONDITIONS**

- 2.1. Pricing. The prices charged to Covad for Local Resale are set forth in Attachment I of this Agreement.
  - 2.1.1. CENTREX Requirements
    - 2.1.1.1. At Covad's option, Covad may purchase the entire set of CENTREX features or a subset of any such features.
    - 2.1.1.2. All features and functions of CENTREX Service, including CENTREX Management System (CMS), whether offered under tariff or otherwise, shall be available to Covad for resale.
    - 2.1.1.3. Sprint shall make information required for an "as is" transfer of CENTREX subscriber service, features, functionalities and CMS capabilities available to Covad.
    - 2.1.1.4. Consistent with Sprint's tariffs, Covad, at its expense, may collect all data and aggregate the CENTREX local exchange, and IntraLATA traffic usage of Covad subscribers to qualify for volume discounts on the basis of such aggregated usage.
    - 2.1.1.5. Covad may request that Sprint suppress the need for Covad subscribers to dial "9" when placing calls outside the CENTREX System. Should Covad request this capability for its subscriber, the subscriber will not be able to use 4-digit dialing.
    - 2.1.1.6. Covad may resell call forwarding in conjunction with CENTREX Service.
    - 2.1.1.7. Covad may purchase any CENTREX Service for resale subject to the requirements of Sprint's tariff.

- 2.1.1.8. Sprint shall make available to Covad for resale intercom calling within the same CENTREX system. To the extent that Sprint offers its own subscribers intercom calling between different CENTREX systems, Sprint shall make such capability available to Covad for resale.
- 2.1.1.9. Covad may resell Automatic Route Selection ("ARS"). Covad may aggregate multiple Covad subscribers on dedicated access facilities where such aggregation is allowed by law, rule or regulation.
- 2.1.2. Voluntary Federal and State Subscriber Financial Assistance Programs
  - 2.1.2.1. Subsidized local Telecommunications Services are provided to low-income subscribers pursuant to requirements established by the appropriate state regulatory body, and include programs such as Voluntary Federal Subscriber Financial Assistance Program and Link-Up America. Voluntary Federal and State Subscriber Financial Assistance Programs are not Telecommunications Services that are available for resale under this Agreement. However, when a Sprint subscriber who is eligible for such a federal program or other similar state program chooses to obtain Local Resale from Covad and Covad serves such subscriber via Local Resale, Sprint shall identify such subscriber's eligibility to participate in such programs to Covad in accordance with the procedures set forth herein.
- 2.1.3. Grandfathered Services. Sprint shall offer for resale to Covad all Grandfathered Services solely for the existing grandfathered base on a customer specific basis. Sprint shall make reasonable efforts to provide Covad with advance copy of any request for the termination of service and/or grandfathering to be filed by Sprint with the Commission.
- 2.1.4. Contract Service Arrangements, Special Arrangements, and Promotions. Sprint shall offer for resale all of its Telecommunications Services available at retail to subscribers who are not Telecommunications Carriers, including but not limited to Contract Service Arrangements (or ICB), Special Arrangements (or ICB), and Promotions in excess of ninety (90) days, all in accordance with FCC and Commission Rules and Regulations.
- 2.1.5. COCOT lines will not be resold at wholesale prices under this Agreement.
- 2.1.6. Hospitality Service. Sprint shall provide all blocking, screening, and all other applicable functions available for hospitality lines under tariff.
- 2.1.7. LIDB Administration
  - 2.1.7.1. Sprint shall maintain customer information for Covad customers who subscribe to resold Sprint local service dial tone lines, in Sprint's LIDB in the same manner that it maintains information in LIDB for its own similarly situated end-user subscribers. Sprint shall update and maintain the Covad information in LIDB on the same schedule that it uses for its own similarly situated end-user subscribers.

2.1.7.2. Until such time as Sprint's LIDB has the software capability to recognize a resold number as Covad's, Sprint shall store the resold number in its LIDB at no charge and shall retain revenue for LIDB look-ups to the resold number.

**ATTACHMENT III**  
**NETWORK ELEMENTS**

**1. GENERAL**

- 1.1. Pursuant to the following terms, Sprint will unbundle and separately price and offer Unbundled Network Elements, (“UNEs”) such that Covad will be able to subscribe to and interconnect to whichever of these unbundled elements Covad requires for the purpose of providing Covad’s Telecommunications Services. Covad may use or combine such Network Elements in any manner Covad chooses to provide Telecommunication Services to its intended customers and users. Covad shall pay Sprint each month for the UNEs provisioned, and shall pay the non-recurring charges calculated in accordance with paragraph 4.1 of Attachment I of this Agreement, as identified in Attachment I, or the charges in Sprint’s tariff, or the charges agreed to by the Parties for services not listed in Attachment I. With the exception of sub-loop elements which are located outside of the central office, Sprint shall deliver the unbundled network elements purchased by Covad to the designated Covad collocation space. It is Covad’s obligation to combine Sprint-provided UNEs with any facilities and services that Covad may itself provide.

**2. UNBUNDLED NETWORK ELEMENTS**

- 2.1. Sprint shall offer UNEs to Covad for the purpose of offering Telecommunication Services to Covad customers and end users. Sprint shall offer UNEs to Covad on an unbundled basis on rates, terms and conditions that are just, reasonable, and non-discriminatory in accordance with the terms and conditions of this Agreement. The initial set of UNEs include:
- 2.1.1. Network Interface Device (“NID”)
  - 2.1.2. Local Loop
  - 2.1.3. Switching Capability
    - 2.1.3.1. Local Switching
    - 2.1.3.2. Tandem Switching
  - 2.1.4. Interoffice Transport Facilities
    - 2.1.4.1. Common
    - 2.1.4.2. Dedicated
  - 2.1.5. Signaling Networks & Call Related Databases
  - 2.1.6. Operations Support Systems
  - 2.1.7. Operator Services & Directory Assistance
- 2.2. Covad may use one or more UNEs to provide any feature, function, capability, or service option that such UNE(s) is (are) technically capable of providing. It is Covad’s obligation to

combine Sprint-provided UNEs with any and all facilities and services whether provided by Sprint, Covad, or any other party.

- 2.3. Each UNE provided by Sprint to Covad shall be at Parity with the quality of design, performance, features, functions, capabilities and other characteristics, including but not limited to levels and types of redundant equipment and facilities for power, diversity and security, that Sprint provides to itself, Sprint's own subscribers, to a Sprint Affiliate or to any other entity.

### **3. BONA FIDE REQUEST PROCESS FOR FURTHER UNBUNDLING**

- 3.1. Each Party shall promptly consider and analyze access to categories of UNE not covered in this Agreement with the submission of a Network Element Bona Fide Request hereunder. The UNE Bona Fide Request process set forth herein does not apply to those services requested pursuant to FCC Rule § 51.319 adopted in First Report & Order, CC Docket No. 96-98, (rel. Aug. 8, 1996).
- 3.2. A UNE Bona Fide Request shall be submitted in writing and shall include a technical description of each requested UNE.
- 3.3. The requesting Party may cancel a UNE Bona Fide Request at any time, but shall pay the other Party's reasonable and demonstrable costs of processing and/or implementing the UNE Bona Fide Request up to the date of cancellation.
- 3.4. Within ten (10) business days of its receipt, the receiving Party shall acknowledge receipt of the UNE Bona Fide Request.
- 3.5. Except under extraordinary circumstances, within thirty (30) days of its receipt of a UNE Bona Fide Request, the receiving Party shall provide to the requesting Party a preliminary analysis of such UNE Bona Fide Request. The preliminary analysis shall confirm that the receiving Party will offer access to the UNE or will provide a detailed explanation that access to the UNE does not qualify as a UNE that is required to be provided under the Act.
- 3.6. Upon receipt of the preliminary analysis, the requesting Party shall, within thirty (30) days, notify the receiving Party of its intent to proceed or not to proceed.
- 3.7. The receiving Party shall promptly proceed with the UNE Bona Fide Request upon receipt of written authorization from the requesting Party. When it receives such authorization, the receiving Party shall promptly develop the requested services, determine their availability, calculate the applicable prices and establish installation intervals.
- 3.8. As soon as feasible, but not more than ninety (90) days after its receipt of authorization to proceed with developing the UNE Bona Fide Request, the receiving Party shall provide to the requesting Party a UNE Bona Fide Request quote which will include, at a minimum, a description of each UNE, the availability, the applicable rates and the installation intervals.
- 3.9. Within thirty (30) days of its receipt of the UNE Bona Fide Request quote, the requesting Party must either confirm its order for the UNE Bona Fide Request pursuant to the UNE Bona Fide Request quote or seek arbitration by the Commission pursuant to § 252 of the

Act.

- 3.10. If a Party to a UNE Bona Fide Request believes that the other Party is not requesting, negotiating or processing the UNE Bona Fide Request in good faith, or disputes a determination, or price or cost quote, such Party may seek mediation or arbitration by the Commission pursuant to § 252 of the Act.

#### 4. NETWORK INTERFACE DEVICE

- 4.1. The NID is a single-line termination device or that portion of a multiple-line termination device required to terminate a single line or circuit. The function of the NID is to establish the network demarcation point between Covad and the end user of its Telecommunications Services. . The NID features two independent chambers or divisions which separate the service provider's network from the subscriber's inside wiring. Each chamber or division contains the appropriate connection points or posts to which the service provider and the subscriber each make their connections. The NID contains a protector which provides a protective ground connection, protection against lightning and other high voltage surges and is capable of terminating cables such as twisted pair cable.
- 4.2. Covad may connect its NID to Sprint's NID; may connect an unbundled loop to its NID; may connect its own Loop to Sprint's NID; or may retain the connection of an unbundled loop to Sprint's NID. Sprint will provide one NID termination for each loop. If additional NID terminations are required, Covad may request them pursuant to process detailed in Article 4 herein.
- 4.3. With respect to multiple-line termination devices, Covad shall specify the quantity of NIDs it requires within such device.

Figure 1 shows a schematic of a NID.

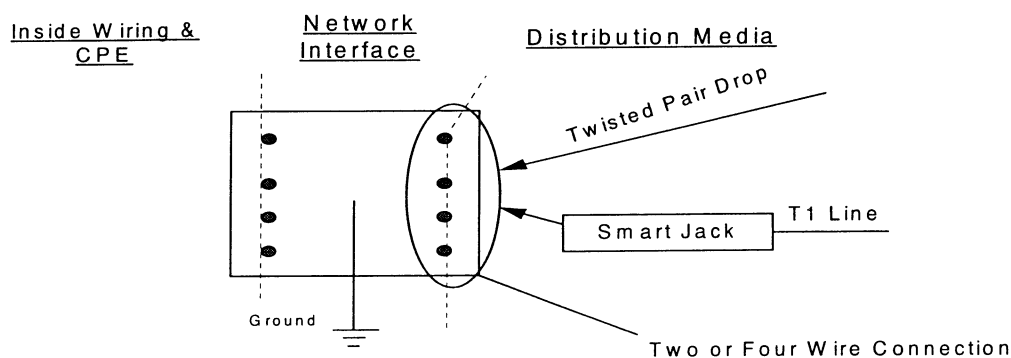

**Figure 1 - Network Interface Device**

- 4.4. Technical Requirements
  - 4.4.1. The Sprint NID shall provide a clean, accessible point of connection for the inside wiring and for the Distribution Media and/or cross connect to Covad's NID and shall maintain a connection to ground that meets the requirements set forth below. Each

party shall ground its NID independently of the other party's NID.

4.4.2. The NID shall be the interface to subscriber's premises wiring for all loop technologies.

## 5. LOOP

5.1. A Loop is a transmission path between the main distribution frame [cross-connect], or its equivalent, in a Sprint Central Office or wire center, and up to the demarcation point at a customer's premises. This includes, but is not limited to, two-wire and four-wire loops that are conditioned to provide analog voice signals, two-wire and four-wire loops that are conditioned to transmit the digital signals needed to provide services such as ISDN BRI and DS1/DS3-level signals, and two-wire and four-wire loops that are conditioned to provide xDSL services. Sprint will provide such xDSL conditioned loops unfettered by any intervening equipment (e.g., filters, load coils, range extenders, bridge taps, etc.), so that Covad can use these loops for a variety of Telecommunications Services that can be supported by use of copper by attaching appropriate terminal equipment at the ends. Where Covad has requested a loop or a portion of a loop for its exclusive use and existing Sprint facilities will not support such request, Covad will pay for that portion of the construction necessary to support its request. (That is, the cost of construction will be allocated between Covad and Sprint based on the proportion of the facility used by Covad to support its request.)

### 5.2. Loop Capabilities

5.2.1. Voice grade loops are loops that facilitate the transmission of analog voice grade signals in the 300-3000 Hz range and terminates in a 2-wire or 4-wire electrical interface at the Covad's customer's premises. Covad shall not install equipment on analog loops that exceeds the specified bandwidth.

5.2.2. Sprint will provide non-voice grade loops on the basis of the service that will be provisioned over the loop. Covad will identify either electronically or in writing (via the service order) the grade of service desired in a particular loop (e.g., ISDN-BRI, PRI, ADSL, HDSL, DS1, etc.) so that the loop may be appropriately identified, and engineered if necessary to meet the appropriate physical, electronic, and spectrum compatibility requirements. If Covad requires a change in the grade of service of a particular loop, (e.g., changing from ISDN service to ADSL), Covad shall notify Sprint electronically or in writing of the requested change in grade of service (via a service order). If Sprint finds that it is not technically feasible to provide the new level of service to Covad pursuant to applicable FCC, Commission or industry requirements or guidelines regarding spectrum management, Sprint will notify Covad that it is unable to meet the request and will provide to Covad the specific technical reason why the loop does not meet requirements. If a particular grade of service is installed, but Covad uses the loop to provide a service that exceeds the engineered capacity of a medium (i.e., Sprint believes that the new service may cause harmful interference to other services) or if the service provided by Covad causes harmful interference to other services, Sprint may suspend that particular service then notify

Covad and work with Covad to develop an agreeable resolution. Sprint will not unilaterally suspend any service based on its assessment of harmful interference without making a good faith attempt to continue service in a manner that does not cause harmful interference. If a particular grade of service is installed or confirmed by Sprint as supportable over the loop but Covad wants to use the loop to provide a service that is below the engineered capacity of the medium (i.e., Covad seeks to use a loop supporting ADSL or SDSL for only IDSL service), then Covad will notify Sprint of the change in service grade.

- 5.2.3. . Covad will submit a BFR for loops that are not currently price-listed.
  - 5.2.4. Reverse ADSL Loops. All DSL ATU-C units in Sprint's network, including those integrated into DSLAMs, should either reside within a Sprint host or remote central office. If an ADSL copper loop should start at an outside location, and is looped through a host or remote, and then to the subscriber, the copper plant from the outside location to the Sprint central office must be a facility dedicated to ADSL transmission only and not part of Sprint's regular feeder or distribution plant.
  - 5.2.5. Covad shall meet the power spectral density requirement given in the respective technical references (including their amendments, augmentations, and replacements) listed below:
  - 5.2.6. For Basic Rate ISDN: Bellcore TR-NWT-000393 Generic Requirements for ISDN Basic Access Digital Subscriber Lines.
  - 5.2.7. For HDSL installations: Bellcore TA-NWT-001210 Generic Requirements for High-Bit-Rate Digital Subscriber Lines. Some fractional T1 derived products operating at 768 kbps may use the same standard.
  - 5.2.8. For ADSL: ANSI T1.413-1995 (Issue 1) Asymmetrical Digital Subscriber Line (ADSL) Metallic Interface, and ANSI T1.413-1998 (Issue 2). . Sprint does not permit the Power Boost option used in its local network. If CLEC requests an ADSL loop, for which the effective loop length exceeds the ADSL standard of 18 kft (or less depending on the wire gauge used in an area), Sprint will only provide a Non-Standard Data Line unfettered by any intervening equipment (e.g., filters, load coils, range extenders, bridge taps, etc.). On a Non-Standard Data Line, Sprint will only provide electrical continuity and line balance.
  - 5.2.9. As an alternative to §§ 5.2.6, 5.2.7 and 5.2.8, Covad may meet the requirements delineated in the most current, approved ANSI Spectral Management Standard or operate in conformity with the requirements established by the FCC relating to spectrum management and interference. (As of the date of signature of this Agreement, current FCC requirements are contained in the *First Report and Order and Further Notice of Proposed Rulemaking, In the Matters of Deployment of Wireline Services Offering Advanced Telecommunications Capability*, FCC 99-48, March 18, 1999.)
- 5.3. Sprint will test loops in excess of 18 kilofeet and, if the loop will support ISDN-BRI, will



condition continuous copper loops in excess of 18 kilofeet (including bridged taps) to support ISDN-BRI to enable provision of Covad's IDSL (ISDN DSL) service. Other digital data loop orders will be provisioned in accordance with § 5.2.8 above.

- 5.4. If Sprint uses Digital Loop Carrier or other similar remote concentration devices, Sprint will make alternative arrangements at Covad's request and option, to provide an unbundled local loop. Alternative arrangements may include copper facilities, dedicated transmission equipment or the deployment of newer devices providing for multiple hosting. Covad agrees to reimburse Sprint for the cost of the modifications necessary to provide alternative arrangements. Such reimbursement shall be on a proportionate basis if the modification results in a shared or multiple use facility.
- 5.5. Should Sprint develop the capability to provide ADSL, SDSL and/or HDSL capable loops through Digital Loop Carrier or other similar remote concentration devices, Sprint will make that capability available to Covad on a parity basis in support of Covad Telecommunications Services. Sprint will consider Covad's present and planned use of local loops in its decision to deploy newer devices providing for multiple hosting and/or providing for support of multiple Telecommunications Services.
- 5.6. Sprint shall provide a firm order commitment to Covad for local loops as indicated in § 2.6.3 of Attachment VII. . Appropriately conditioned loops shall be made available to at the intervals noted in § 2.6.3 of Attachment VII.
- 5.7. When Sprint has completed the provisioning process, Sprint will complete the order and then Covad will be able to perform tests on the loop to verify that it meets ordered grade of service requirements before accepting the loop. Should Covad not accept the loop, Covad will report the trouble and the Sprint technician will perform any corrective action possible to turn up the circuit.

## **6. LOCAL SWITCHING**

- 6.1. Local Switching is the Network Element that provides the functionality required to connect the appropriate lines or trunks wired to the Main Distributing Frame (MDF) or Digital Cross Connect (DSX) panel to a desired line or trunk. Such functionality shall include all of the features, functions, and capabilities that the underlying Sprint switch providing such Local Switching function provides for Sprint's own services. Functionality may include, but is not limited to: line signaling and signaling software, digit reception, dialed number translations, call screening, routing, recording, call supervision, dial tone, switching, telephone number provisioning, announcements, calling features and capabilities (including call processing), Centrex, or Centrex like services, Automatic Call Distributor (ACD), CLEC pre-subscription (e.g., long distance Carrier, intraLATA toll), Carrier Identification Code (CIC) portability capabilities, testing and other operational features inherent to the switch and switch software.
- 6.2. Technical Requirements
  - 6.2.1. Sprint shall provide its standard recorded announcements (as designated by Covad) and call progress tones to alert callers of call progress and disposition. Covad will

use the BFR process for unique announcements.

- 6.2.2. Sprint shall change a subscriber from Sprint's Telecommunications Services to Covad's Telecommunications Services without loss of feature functionality unless expressly agreed otherwise by Covad.
- 6.2.3. Sprint shall control congestion points such as mass calling events, and network routing abnormalities, using capabilities such as Automatic Call Gapping, Automatic Congestion Control, and Network Routing Overflow. Application of such control shall be competitively neutral and not favor any user of unbundled switching or Sprint.
- 6.2.4. Sprint shall offer all Local Switching features that are technically feasible and provide feature offerings at Parity with those provided by Sprint to itself or any other party.
- 6.3. Interface Requirements. Sprint shall provide the following interfaces:
  - 6.3.1. Standard Tip/Ring interface including loopstart or groundstart, on-hook signaling (e.g.: for calling number, calling name and message waiting lamp);
  - 6.3.2. Coin phone signaling;
  - 6.3.3. Basic and Primary Rate Interface ISDN adhering to ANSI standards Q.931, Q.932 and appropriate Bellcore Technical Requirements;
  - 6.3.4. Two-wire analog interface to PBX to include reverse battery, E&M, wink start and DID;
  - 6.3.5. Four-wire analog interface to PBX to include reverse battery, E&M, wink start and DID; and
  - 6.3.6. Four-wire DS1 interface to PBX or subscriber provided equipment (e.g., computers and voice response systems).
- 6.4. Sprint shall provide access to interfaces, including but not limited to:
  - 6.4.1. SS7 Signaling Network, Dial Pulse or Multi-Frequency trunking if requested by Covad;
  - 6.4.2. Interface to Covad operator services systems or Operator Services through appropriate trunk interconnections for the system; and
  - 6.4.3. Interface to Covad directory assistance services through the Covad switched network or to Directory Services through the appropriate trunk interconnections for the system; and 950 access or other Covad required access to interexchange carriers as requested through appropriate trunk interfaces.

## **7. TANDEM SWITCHING**

- 7.1. Tandem Switching is the function that establishes a communications path between two

switching offices (connecting trunks to trunks) through a third switching office (the tandem switch) including but not limited to Covad, Sprint, independent telephone companies, IXCs and wireless Carriers. A host/remote end office configuration is not a Tandem Switching arrangement.

## 7.2. Technical Requirements

7.2.1. The requirements for Tandem Switching include, but are not limited to, the following:

7.2.1.1. Interconnection to Sprint tandem(s) will provide Covad local interconnection for local and toll access service purposes to the Sprint end offices and NXXs which interconnect with that tandem(s) either directly or through other Sprint facilities for local and toll service purposes, and to other companies which are likewise connected to that tandem(s).

7.2.1.2. Interconnection to a Sprint tandem for transit purposes will provide Covad interexchange access to Sprint IXCs, other local carriers, ILECs, and CMRS providers which are connected to that tandem.

7.2.1.3. Where a Sprint Tandem Switch also provides End-Office Switch functions, interconnection to a Sprint tandem serving that exchange will also provide Covad access to Sprint's end offices.

7.2.2. Tandem Switching shall preserve CLASS/LASS features and Caller ID as traffic is processed.

7.2.3. To the extent technically feasible, Tandem Switching shall record billable events for distribution to the billing center designated by Covad.

7.2.4. Tandem Switching shall control congestion using capabilities such as Automatic Congestion Control and Network Routing Overflow. Congestion control provided or imposed on Covad traffic shall be at Parity with controls being provided or imposed on Sprint traffic (e.g., Sprint shall not block Covad traffic and leave its traffic unaffected or less affected).

7.2.5. The Local Switching and Tandem Switching functions may be combined in an office. If this is done, both Local Switching and Tandem Switching shall provide all of the functionality required of each of those Network Elements in this Agreement.

7.2.6. Tandem Switching shall provide interconnection to the E911 PSAP where the underlying Tandem is acting as the E911 Tandem.

## 7.3. Interface Requirements

7.3.1. Direct trunks will be utilized for interconnection to Sprint Tandems, excluding transit traffic via common trunks as may be required under the Act.

7.3.2. Sprint shall provide all signaling necessary to provide Tandem Switching with no loss of feature functionality.

## **8. TRANSPORT**

### **8.1. Common Transport**

- 8.1.1. Common Transport provides a local interoffice transmission path between the Sprint tandem switch and a Sprint or CLEC end office switch, or between a host in one rate center and a remote in another rate center. Common transport is shared between multiple carriers and is required to be switched at the tandem.
- 8.1.2. Sprint may provide Common Transport at DS-0, DS-1, DS-3, STS-1 or higher transmission bit rate circuits.
- 8.1.3. Sprint shall be responsible for the engineering, provisioning, and maintenance of the underlying Sprint equipment and facilities that are used to provide Common Transport.

### **8.2. Dedicated Transport**

- 8.2.1. Dedicated Transport provides a local interoffice transmission path between Sprint and/or Covad offices and points of presence. Dedicated transport is limited to the use of a single carrier and does not require switching at a tandem.
- 8.2.2. Technical Requirements
  - 8.2.2.1. Where technologically feasible and available, Sprint shall offer Dedicated Transport consistent with the underlying technology as follows:
  - 8.2.2.2. When Sprint provides Dedicated Transport, the entire designated transmission circuit (e.g.: DS-1, DS-3, STS-1) shall be dedicated to Covad designated traffic.
  - 8.2.2.3. Where Sprint has technology available, Sprint shall offer Dedicated Transport using currently available technologies including, but not limited to, DS1 and DS3 transport systems, SONET (or SDH) Bi-directional Line Switched Rings, SONET (or SDH) Unidirectional Path Switched Rings, and SONET (or SDH) point-to-point transport systems (including linear add-drop systems), at all available transmission bit rates, including but not limited to OC- and OC-12.

## **9. SIGNALING SYSTEMS AND DATABASES**

### **9.1. Signaling Systems**

#### **9.1.1. Signaling Link Transport**

- 9.1.1.1. Signaling Link Transport is a set of two or four dedicated 56 Kbps transmission paths between Covad-designated Signaling Points of Interconnection (SPOI) that provides appropriate physical diversity and a cross connect at a Sprint STP site.

9.1.1.2. Technical Requirements. Signaling Link Transport shall consist of full duplex mode 56 Kbps transmission paths.

9.1.2. Signaling Transfer Points (STPs)

9.1.2.1. Signaling Transfer Points (STPs) provide functionality that enable the exchange of SS7 messages among and between switching elements, database elements and signaling transfer points.

9.1.2.2. Figure 2 depicts Signaling Transfer Points.

**Signaling Transfer Points.**

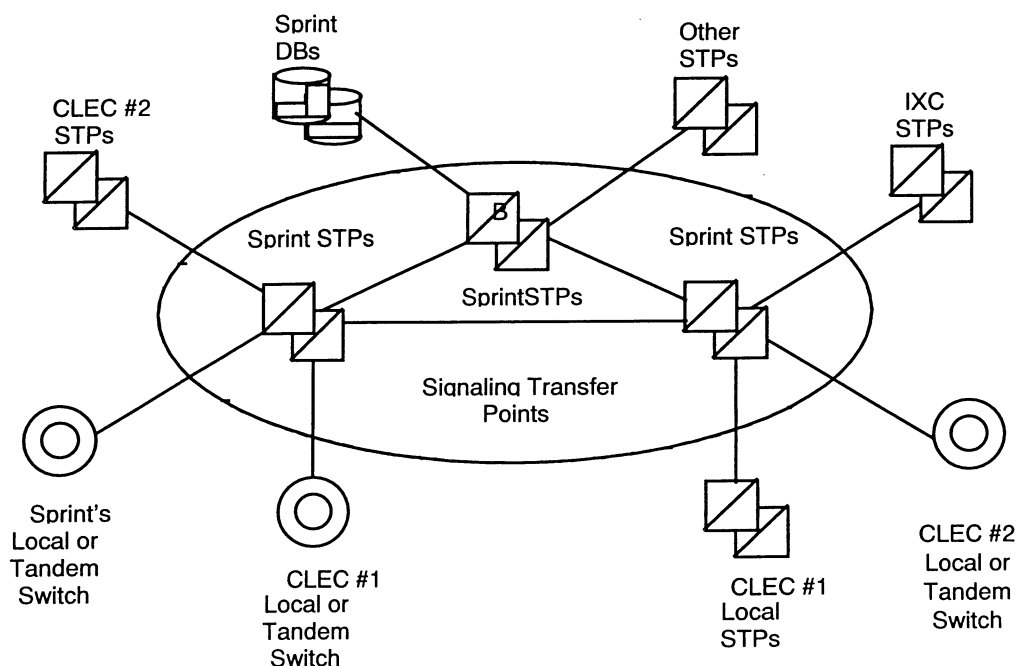

**Figure 2**

9.1.2.3. Technical Requirements. STPs shall provide access to and fully support the functions of all other Network Elements connected to the Sprint SS7 network. These include:

- 9.1.2.3.1. Sprint Local Switching or Tandem Switching;
- 9.1.2.3.2. Sprint Service Control Points/Data Bases;
- 9.1.2.3.3. Third-party local or Tandem Switching systems; and

9.1.2.3.4. Third-party-provided STPs.

9.1.2.4. Interface Requirements: Sprint shall provide the following STP options to connect Covad or Covad-designated local switching systems or STPs to the Sprint SS7 network:

9.1.2.4.1. An A-link interface from Covad local switching systems; and

9.1.2.4.2. B or D-link interface from Covad STPs.

9.1.2.4.3. Each type of interface shall be provided by one or more sets (layers) of signaling links, as follows:

9.1.2.4.4. An A-link layer shall consist of two links, as depicted in Figure 3.

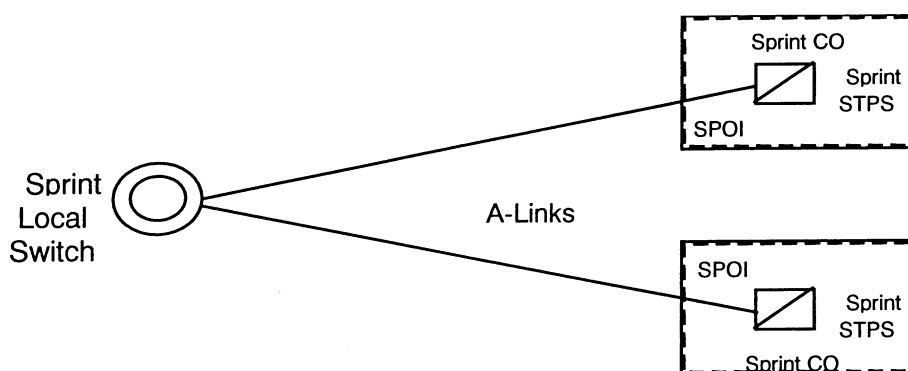

**Figure 3. A-Link Interface**

9.1.2.4.5. A B or D-link layer shall consist of four links, as depicted in Figure 4.

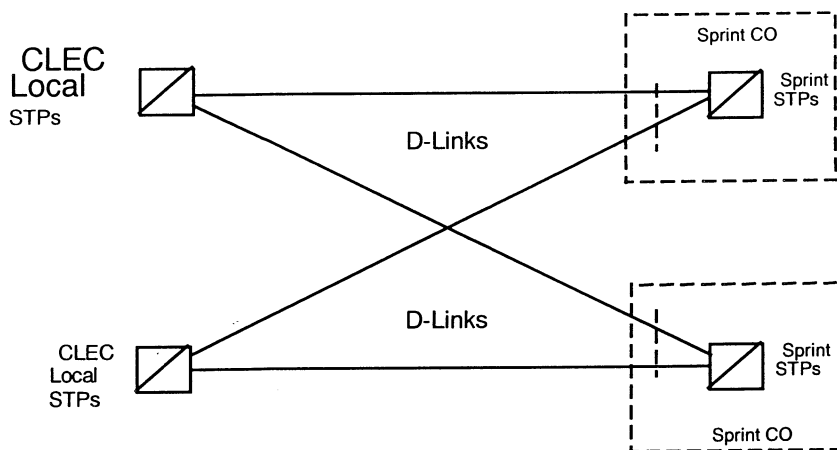

Figure 4. D-Link Interface

9.1.2.4.6. Signaling Point of Interconnection (SPOI) for each link shall be located at a cross-connect element, such as a DSX-1, in the Central Office (CO) where the Sprint STPs is located. There shall be a DS-1 or higher rate transport interface at each of the SPOIs. Each signaling link shall appear as a DS-0 channel within the DS-1 or higher rate interface.

## 9.2. Line Information Database (LIDB)

9.2.1. The LIDB is a transaction-oriented database accessible CCS networks. It contains records associated with subscribers Line Numbers and Special Billing Numbers. LIDB accepts queries from other Network Elements, or Covad's network, and provides appropriate responses. The query originator need not be the owner of LIDB data. LIDB queries include functions such as screening billed numbers that provides the ability to accept Collect or Third Number Billing calls and validation of Telephone Line Number based non-proprietary calling cards. The interface for the LIDB functionality is the interface between the Sprint CCS network and other CCS networks. LIDB also interfaces to administrative systems. The administrative system interface provides Work Centers with an interface to LIDB for functions such as provisioning, auditing of data, access to LIDB measurements and reports.

### 9.2.2. Technical Requirements

9.2.2.1. Prior to the availability of Local Number Portability, Sprint shall enable Covad to store in Sprint's LIDB any subscriber Line Number or Special Billing Number record, whether ported or not, for which the NPA-NXX or NXX-0/1XX Group is supported by that LIDB, and NPA-NXX and NXX-0/1XX Group Records, belonging to an NPA-NXX or NXX-0/1XX owned by Covad.

9.2.2.2. Subsequent to the availability of a long-term solution for Number Portability, Sprint, under the terms of a separate agreement with Covad, shall

enable Covad to store in Sprint's LIDB any subscriber Line Number or Special Billing Number record, whether ported or not, regardless of the number's NPA-NXX or NXX-0/1XX.

9.2.2.3. Sprint shall perform the following LIDB functions for Covad's subscriber records in LIDB: Billed Number Screening (provides information such as whether the Billed Number may accept Collect or Third Number Billing calls); and Calling Card Validation.

9.2.2.4. Sprint shall process Covad's subscriber records in LIDB at Parity with Sprint subscriber records, with respect to other LIDB functions Sprint shall indicate to Covad what additional functions (if any) are performed by LIDB in their network.

9.2.2.5. Sprint shall perform backup and recovery of all of Covad's data in LIDB at Parity with backup and recovery of all other records in the LIDB, including sending to LIDB all changes made since the date of the most recent backup copy.

### 9.3. Toll Free Number Database

9.3.1. The Toll Free Number Database provides functionality necessary for toll free (e.g.: 800 and 888) number services by providing routing information and additional vertical features during call set-up in response to queries from STPs. Sprint, under the terms of a separate agreement with Covad, shall provide the Toll Free Number Database in accordance with the following:

#### 9.3.2. Technical Requirements

9.3.2.1. Sprint shall make the Sprint Toll Free Number Database available for Covad to query, from Covad's designated switch including Sprint unbundled local switching with a toll-free number and originating information.

9.3.2.2. The Toll Free Number Database shall return Covad identification and, where applicable, the queried toll free number, translated numbers and instructions as it would in response to a query from a Sprint switch.

9.3.3. Interface Requirements. The signaling interface between the CLEC or other local switch and the Toll-Free Number database shall use the TCAP protocol, together with the signaling network interface.

## 10. OPERATOR SERVICES

10.1. Sprint shall provide for the routing of local Operator Services calls (including but not limited to 0+, 0-) dialed by Covad subscribers directly to either the Covad Operator Service platform to the extent Sprint's switch can perform this customized routing, or Sprint Operator Service to the extent there is a Sprint provided Operator Service platform for that serving area.

10.1.1. Sprint shall provide Operator Services to Covad as described below until, at Covad's



discretion, Sprint routes calls to the Covad Local Operator Services platform.

10.1.1.1. Sprint agrees to provide Covad subscribers the same Operator Services available to Sprint subscribers to the extent there is a Sprint provided Operator Services platform for the serving area. Sprint shall make available its service enhancements on a non-discriminatory basis.

10.1.1.2. Operator Services provided to Covad subscribers shall be branded in accordance with Part B, Article 10 of this Agreement.

10.1.1.3. Sprint shall exercise the same level of fraud control in providing Operator Service to Covad that Sprint provides for its own Operator Service.

## **11. DIRECTORY ASSISTANCE SERVICE**

11.1. Sprint shall provide for the routing of directory assistance calls (including but not limited to 411, 555-1212, NPA-555-1212) dialed by Covad subscribers directly to, at Covad's option, either (a) the Covad DA service platform to the extent Sprint's switch can perform this customized routing, or (b) Sprint's DA service platform to the extent there is a Sprint provided DA service platform for that serving area.

11.1.1. Sprint shall provide Covad with the same level of support for the provisioning of Directory Assistance as Sprint provides itself. Quality of service standards shall be measured at the aggregate level in accordance with standards and performance measurements that are at Parity with the standards and/or performance measurements that Sprint uses and/or which are required by law or regulatory agency rules or orders.

11.1.2. Directory Assistance services provided by Sprint to Covad subscribers shall be branded in accordance with Part B, Article 10 of this Agreement.

**ATTACHMENT IV  
INTERCONNECTION**

**1. LOCAL INTERCONNECTION TRUNK ARRANGEMENT**

- 1.1. The Parties agree to initially use two-way trunks (one-way directionalized) for an interim period. The Parties shall transition from directionalized two-way trunks upon mutual agreement, absent engineering or billing issues. The Parties shall transition all one-way trunks established under this Agreement.
- 1.1.1. The Parties shall initially reciprocally terminate Local Traffic and IntraLATA/InterLATA toll calls originating on the other Party's network as follows:
- 1.1.1.1. The Parties shall make available to each other two-way trunks for the reciprocal exchange of combined Local Traffic, and non-equal access IntraLATA toll traffic. Neither Party is obligated under this Agreement to order reciprocal trunks or build facilities in the establishment of interconnection arrangements for the delivery of Internet traffic. The Party serving the Internet service provider shall order trunks or facilities from the appropriate tariff of the other Party for such purposes and will be obligated to pay the full cost of such facility.
- 1.1.1.2. Separate two-way trunks will be made available for the exchange of equal-access InterLATA or IntraLATA interexchange traffic that transits Sprint's network.
- 1.1.1.3. Separate trunks will be utilized for connecting Covad's switch to each 911/E911 tandem.
- 1.1.1.4. Separate trunk groups will be utilized for connecting Covad's Operator Service Center to Sprint's Operator Service center for operator-assisted busy line interrupt/verify.
- 1.1.1.5. Separate trunk groups will be utilized for connecting Covad's switch to Sprint's Directory Assistance center in instances where Covad is purchasing Sprint's unbundled Directory Assistance service.
- 1.2. Point of Interconnection
- 1.2.1. Point of Interconnection (POI) means the physical point that establishes the technical interface, the test point, and the operational responsibility hand-off between Covad and Sprint for the local interconnection of their networks. Covad is limited to constructing one POI in each Sprint LATA.
- 1.2.2. Covad will be responsible for engineering and maintaining its network on its side of the POI. Sprint will be responsible for engineering and maintaining its network on its side of the POI.
- 1.2.3. For construction of new facilities when the parties choose to interconnect at a mid-

span meet, Covad and Sprint will jointly provision the facilities that connect the two networks. Sprint will be the “controlling carrier” for purposes of MECOD guidelines, as described in the joint implementation plan. Sprint will provide fifty percent (50%) of the facilities or to its exchange boundary, whichever is less.

1.2.4. Should Covad prefer, new interconnection facilities may be provisioned via third party facilities or Covad lease of tariffed services from Sprint. Special construction charges, if applicable, will be charged in accordance with Sprint’s access service tariff.

1.2.4.1. If third party leased facilities are used for interconnection, or if leased facilities are provided under a meet-point arrangement between Sprint and a third-party, the POI will be defined as the Sprint office in which the leased circuit terminates. Covad is responsible to terminate the leased facility in a collocation space (if unbundled loops or switched ports will be purchased in the central office) or a set of Sprint-provided DSX jacks to clearly establish the POI.

1.2.4.2. If Sprint-provided-leased facilities are used, the POI will be defined as the demarcation point between Sprint's facility and Covad's equipment as long as the end point is within Sprint's exchange area.

## **2. INTERCONNECTION COMPENSATION MECHANISMS**

2.1. Each party is responsible for bringing their facilities to POI.

2.2. Interconnection Compensation

2.2.1. If Sprint provides one-hundred percent (100%) of the facility, Sprint will charge Covad one-hundred percent (100%) of the lease rates for the facility. Covad may charge Sprint a proportionate amount of Sprint’s dedicated transport rate based on the use of the facility as described above.

2.2.2. If a meet-point is established via construction of new facilities or re-arrangement of existing physical facilities between Sprint and Covad, the relative use factor will be reduced by the proportionate length of haul provided by each party. Sprint shall be responsible for network provisioning as described in § 1.2.3 herein.

2.2.3. If Covad provides one-hundred percent (100%) of the interconnection facility via lease of meet-point circuits between Sprint and a third-party; lease of third party facilities; or construction of its own facilities; Covad may charge Sprint for proportionate amount based on relative usage using the lesser of:

2.2.3.1. Sprint’s dedicated interconnection rate;

2.2.3.2. Its own costs if filed and approved by a commission of appropriate jurisdiction; and

2.2.3.3. The actual lease cost of the interconnecting facility.

- 2.3. Compensation for Local Traffic Transport and Termination
- 2.3.1. The POI determines the point at which the originating carrier shall pay the terminating carrier for the completion of that traffic. The following compensation elements shall apply:
- 2.3.1.1. “Transport,” which includes dedicated and common transport and any necessary Tandem Switching of Local Traffic from the interconnection point between the two carriers to the terminating carrier’s end-office switch that directly serves the called end-user; and
- 2.3.1.2. “Termination,” which includes the switching of Local Traffic at the terminating carrier’s end office switch.
- 2.4. When a Covad subscriber places a call to Sprint’s subscriber, Covad will hand off that call to Sprint at the POI. Conversely, when Sprint hands off Local Traffic to Covad for Covad to transport and terminate, Sprint may use the established POI or Sprint may designate its own POI.
- 2.4.1. Covad and Sprint may each designate a POI at any technically feasible point including but not limited to any electronic or manual cross-connect points, collocations, entrance facilities, and mid-span meets. The transport and termination charges for Local Traffic flowing through a POI shall be as follows:
- 2.4.1.1. When calls from Covad are terminating on Sprint’s network through the Sprint Tandem Switch, Covad will pay Sprint for transport charges from the POI to the Tandem for dedicated transport. Covad shall also pay a charge for Tandem Switching, common transport to the end office, and end-office termination.
- 2.4.1.2. When Sprint terminates calls to Covad’s subscribers using Covad’s switch, Sprint shall pay Covad for transport charges from the POI to the Covad switching center for dedicated transport. Sprint shall also pay to Covad a charge symmetrical to its own charges for the functionality actually provided by Covad for call termination.
- 2.4.1.3. Covad may choose to establish direct trunking to any given end office. If Covad leases trunks from Sprint, it shall pay charges for dedicated transport. For calls terminating from Covad to subscribers served by these directly-trunked end offices, Covad shall also pay an end-office termination. For Sprint traffic terminating to Covad over the direct end office trunking, compensation payable by Sprint shall be the same as that detailed in § 2.4.1.2 above.

### 3. SIGNALING

- 3.1. Signaling protocol. The parties will interconnect their networks using SS7 signaling where technically feasible and available as defined in FR 905 Bellcore Standards including ISDN

user part (ISUP) for trunk signaling and TCAP for CCS-based features in the interconnection of their networks. All Network Operations Forum (NOF) adopted standards shall be adhered to.

- 3.2. Refer to Attachment III, Article 9 for detailed terms of SS7 Network Interconnection.
- 3.3. Standard interconnection facilities shall be extended superframe (ESF) with B8ZS line code. Where ESF/B8ZS is not available, Covad will agree to using other interconnection protocols on an interim basis until the standard ESF/B8ZS is available. Sprint will provide anticipated dates of availability for those areas not currently ESF/B8ZS compatible.
  - 3.3.1. Where Covad is unwilling to utilize an alternate interconnection protocol, Covad will provide Sprint an initial forecast of 64 Kbps clear channel capability (“64K CCC”) trunk quantities within thirty (30) days of the Effective Date consistent with the forecasting agreements between the parties. Upon receipt of this forecast, the parties will begin joint planning for the engineering, procurement, and installation of the segregated 64K CCC Local Interconnection Trunk Groups, and the associated ESF facilities, for the sole purpose of transmitting 64K CCC data calls between Covad and Sprint. Where additional equipment is required, such equipment would be obtained, engineered, and installed on the same basis and with the same intervals as any similar growth job for IXC, Covad, or Sprint internal customer demand for 64K CCC trunks.

#### **4. NETWORK SERVICING**

##### **4.1. Trunk Forecasting**

4.1.1. The Parties shall work towards the development of joint forecasting responsibilities for traffic utilization over trunk groups. Orders for trunks that exceed forecasted quantities for forecasted locations will be accommodated as facilities and or equipment are available. The Parties shall make all reasonable efforts and cooperate in good faith to develop alternative solutions to accommodate orders when facilities are not available. Intercompany forecast information must be provided by the Parties to each other twice a year. The initial trunk forecast meeting should take place soon after the first implementation meeting. A forecast should be provided at or prior to the first implementation meeting. The semi-annual forecasts shall project trunk gain/loss on a monthly basis for the forecast period, and shall include:

4.1.1.1. Semi-annual forecasted trunk quantities (which include baseline data that reflect actual Tandem and end office Local Interconnection and meet point trunks and Tandem-subtending Local Interconnection end office equivalent trunk requirements) for no more than two years (current plus one year);

4.1.1.2. The use of Common Language Location Identifier (CLLI-MSG), which are described in Bellcore documents BR 795-100-100 and BR 795-400-100;

4.1.1.3. Description of major network projects that affect the other Party will be

provided in the semi-annual forecasts. Major network projects include but are not limited to trunking or network rearrangements, shifts in anticipated traffic patterns, or other activities by either party that are reflected by a significant increase or decrease in trunking demand for the following forecasting period.

- 4.1.2. Parties shall meet to review and reconcile their forecasts if forecasts vary significantly.
- 4.1.3. Each Party shall provide a specified point of contact for planning forecasting and trunk servicing purposes.
- 4.1.4. Trunking can be established to Tandems or end offices or a combination of both via either one-way or two-way trunks. Trunking will be at the DS-0, DS-1, DS-3/OC-3 level, or higher, as agreed upon by Covad and Sprint.
- 4.1.5. The parties agree to abide by the following if a forecast cannot be agreed to: local interconnection trunk groups will be provisioned to the higher forecast. A blocking standard of one percent (1%) during the average busy hour shall be maintained. Should the Parties not agree upon the forecast, and the Parties engineer facilities at the higher forecast, the Parties agree to abide by the following:
  - 4.1.5.1. In the event that one Party over-forecasts its trunking requirements by twenty percent (20%) or more, and the other Party acts upon this forecast to its detriment, the other Party may recoup any actual and reasonable expense it incurs.
  - 4.1.5.2. The calculation of the twenty percent (20%) over-forecast will be based on the number of DS-1 equivalents for the total traffic volume to Sprint.
  - 4.1.5.3. Expenses will only be recouped for non-recoverable facilities that cannot otherwise be used at any time within twelve (12) months after the initial installation for another purpose including but not limited to: other traffic growth between the Parties, internal use, or use with another party.
- 4.2. Grade of Service. A blocking standard of one percent (1%) during the average busy hour, as defined by each Party's standards, for final trunk groups between a Covad end office and a Sprint access Tandem carrying meet point traffic shall be maintained. All other final trunk groups are to be engineered with a blocking standard of one percent (1%). Direct end office trunk groups are to be engineered with a blocking standard of one percent (1%).
- 4.3. Trunk Servicing. Orders between the Parties to establish, add, change or disconnect trunks shall be processed by use of an ASR, or another industry standard eventually adopted to replace the ASR for trunk ordering.

## 5. NETWORK MANAGEMENT

- 5.1. Protective Protocols. Either Party may use protective network traffic management controls such as 7-digit and 10-digit code gaps on traffic toward each other's network, when required

to protect the public switched network from congestion due to facility failures, switch congestion or failure or focused overload. Covad and Sprint will immediately notify each other of any protective control action planned or executed.

- 5.2. Expansive Protocols. Where the capability exists, originating or terminating traffic reroutes may be implemented by either party to temporarily relieve network congestion due to facility failures or abnormal calling patterns. Reroutes will not be used to circumvent normal trunk servicing. Expansive controls will only be used when mutually agreed to by the parties.
- 5.3. Mass Calling. Covad and Sprint shall cooperate and share pre-planning information, where available, regarding cross-network call-ins expected to generate large or focused temporary increases in call volumes, to prevent or mitigate the impact of these events on the public switched network. Mass calling numbers are not cannot be used in conjunction with INP.

## **6. USAGE MEASUREMENT**

- 6.1. Each Party shall calculate terminating interconnection minutes of use based on standard AMA recordings made within each Party's network, these recordings being necessary for each Party to generate bills to the other Party. In the event either Party cannot measure minutes terminating on its network where technically feasible, the other Party shall provide the measuring mechanism or the Parties shall otherwise agree on an alternate arrangement.
- 6.2. Measurement of minutes of use over Local Interconnection trunk groups shall be in actual conversation seconds. The total conversation seconds over each individual Local Interconnection trunk group will be totaled for the entire monthly bill period and then rounded to the next whole minute.
- 6.3. Prior to the commencement of billing for interconnection, each Party shall provide to the other, the PLU of the traffic terminated to each other over the Local Interconnection trunk groups.
  - 6.3.1. The Parties agree to review the accuracy of the PLU on a regular basis. If the initial PLU is determined to be inaccurate by more than twenty percent (20%), the Parties agree to implement the new PLU retroactively to the Effective Date of the contract.

## **7. TRANSIT TRAFFIC**

- 7.1. Transit Traffic means the delivery of local traffic by Covad or Sprint originated by the end user of one Party and terminated to a third party LEC, ILEC, or CMRS provider over the local/intraLATA interconnection trunks. The following traffic types will be delivered by either Party: local traffic and intraLATA toll and switched traffic originated from Covad or Sprint and delivered to such third party LEC, ILEC or CMRS; and intraLATA 800 traffic.
- 7.2. Terms and Conditions
  - 7.2.1. Each Party acknowledges that it is the originating Party's responsibility to enter into arrangements with each third party LEC, ILEC, or CMRS provider for the exchange of transit traffic to that third party, unless the Parties agree otherwise in writing.

7.2.2. Each Party acknowledges that the transiting Party does not have any responsibility to pay any third party LEC, ILEC, or CMRS provider charges for termination or any identifiable transit traffic from the originating Party. Both Parties reserve the right not to pay such charges on behalf of the originating Party.

### 7.3. Payment Terms and Conditions

7.3.1. In addition to the payment terms and conditions contained in other sections of this Agreement, the Parties shall compensate each other for transit service as follows:

7.3.1.1. The originating Party shall pay to the transiting Party a transit service charge as set forth in the Pricing Schedule; and

7.3.1.2. If the terminating Party requests, and the transiting Party does not provide, the terminating Party with the originating record in order for the terminating Party to bill the originating Party, the terminating Party shall default bill the transiting Party for transited traffic which does not identify the originating Party.

### 7.4. Billing Records and Exchange of Data

7.4.1. Parties will use the best efforts to convert all networks transporting transit traffic to deliver each call to the other Party's network with SS7 Common Channel Interoffice Signaling (CCIS) and other appropriate TCAP messages in order to facilitate full interoperability and billing functions. The Parties agree to send all message indicators, including originating telephone number, local routing number and CIC.

7.4.2. The transiting Party agrees to provide the terminating Party information on traffic originated by a third party CLEC, ILEC, or CMRS provider. To the extent Sprint incurs additional cost in providing this billing information, Covad agrees to reimburse Sprint for its direct costs of providing this information.

7.4.3. To the extent that the industry adopts a standard record format for recording originating and/or terminating transit calls, both Parties agree to comply with the industry-adopted format to exchange records.

## 8. RESPONSIBILITIES OF THE PARTIES

8.1. Sprint and Covad will review engineering requirements consistent with the Implementation Plan described in Part B, Article 30 and Part C, Attachment IV, Article 4 and otherwise as set forth in this Agreement.

8.2. Covad and Sprint shall share responsibility for all Control Office functions for Local Interconnection Trunks and Trunk Groups, and both parties shall share the overall coordination, installation, and maintenance responsibilities for these trunks and trunk groups.

8.3. Covad and Sprint shall.

8.3.1. Provide trained personnel with adequate and compatible test equipment to work with



each other's technicians.

- 8.3.2. Notify each other when there is any change affecting the service requested, including the due date.
- 8.3.3. Coordinate and schedule testing activities of their own personnel, and others as applicable, to ensure its interconnection trunks/trunk groups are installed per the interconnection order, meet agreed-upon acceptance test requirements, and are placed in service by the due date.
- 8.3.4. Perform sectionalization to determine if a trouble is located in its facility or its portion of the interconnection trunks prior to referring the trouble to each other.
- 8.3.5. Advise each other's Control Office if there is an equipment failure which may affect the interconnection trunks.
- 8.3.6. Provide each other with a trouble reporting/repair contact number that is readily accessible and available twenty-four (24) hours/seven (7) days a week. Any changes to this contact arrangement must be immediately provided to the other party.
- 8.3.7. Provide to each other test-line numbers and access to test lines.
- 8.3.8. Cooperatively plan and implement coordinated repair procedures for the meet point and Local Interconnection trunks and facilities to ensure trouble reports are resolved in a timely and appropriate manner.

**ATTACHMENT V**  
**INTERIM NUMBER PORTABILITY**

**1. SPRINT PROVISION OF INTERIM NUMBER PORTABILITY**

- 1.1. Sprint shall provide INP in accordance with requirements of the Act and FCC Rules and Regulations. INP shall be provided with minimum impairment of functionality, quality, reliability and convenience to subscribers of Covad services until such time as LNP service is offered in the Sprint rate center, in which case INP will be discontinued. Beginning on the date LNP is available in an area, INP orders will no longer be processed, and the Parties will work together to convert the existing INP lines to LNP.

**2. INTERIM NUMBER PORTABILITY**

- 2.1. Interim Number Portability (INP) shall be provided to the extent technical capabilities allow, by a Sprint directed Remote Call Forwarding (RCF). In the event RCF is a purchased feature of the Covad end user, there is no relationship between RCF and INP. Once LNP is generally available in Sprint's serving area, RCF will be provided only as a retail service offering by Sprint.
- 2.2. Remote Call Forwarding (RCF) is an INP method to provide subscribers with service-provider portability by redirecting calls within the telephone network. When RCF is used to provide interim number portability, calls to the ported number will first route to the Sprint switch to which the ported number was previously assigned. The Sprint switch will then forward the call to a number associated with the Covad designated switch to which the number is ported. Covad may order any additional paths to handle multiple simultaneous calls to the same ported telephone number.
- 2.3. The trunking requirements will be agreed upon by Sprint and Covad resultant from application of sound engineering principles. These trunking options may include SS7 signaling, in-band signaling, and may be one-way or two-way. The trunks used may be the same as those used for exchange of other Local Traffic and toll traffic between Sprint and Covad.
- 2.4. Local Exchange Routing Guide (LERG) Reassignment. Portability for an entire NXX shall be provided by utilizing reassignment of the block to Covad through the LERG. Updates to translations in the Sprint switching office from which the telephone number is ported will be made by Sprint prior to the date on which LERG changes become effective, in order to redirect calls to the Covad switch via route indexing.
- 2.5. Other Currently Available Number Portability Provisions:
- 2.5.1. Where SS7 is available, Sprint shall exchange with Covad, SS7 TCAP messages as required for the implementation CLASS or other features available in the Sprint network, if technically feasible.
- 2.5.2. Upon notification that Covad will be initiating INP, Sprint shall disclose to Covad

any technical or capacity limitations that would prevent use of the requested INP in the affected switching office. Sprint and Covad shall cooperate in the process of porting numbers to minimize subscriber out-of-service time, including promptly updating switch translations, where necessary, after notification that physical cut-over has been completed (or initiated), as Covad may designate.

2.5.3. For INP, Covad shall have the right to use the existing Sprint 911 infrastructure for all 911 capabilities. When RCF is used for Covad subscribers, both the ported numbers and shadow numbers shall be stored in ALI databases. Covad shall have the right to verify the accuracy of the information in the ALI databases.

2.5.3.1. When any INP method is used to port a subscriber, the donor provider must maintain the LIDB record for that number to reflect appropriate conditions as reported to it by the porting service provider. The donor must outclear call records to Covad for billing and collection from the subscriber. Until such time as Sprint's LIDB has the software capability to recognize a ported number as Covad's, Sprint shall store the ported number in its LIDB at no charge and shall retain revenue for LIDB look-ups to the ported number. At such time as Sprint's LIDB has the software capability to recognize that the ported number is Covad's then, if Covad desires to store numbers on Sprint's LIDB, the parties shall negotiate a separate LIDB database storage and look-up agreement.

2.5.4. Sprint will send a CARE transaction 2231 to notify IXC that access is now provided by a new Covad for that number.

### **3. REQUIREMENTS FOR INP**

#### **3.1. Cut-Over Process**

3.1.1. Sprint and Covad shall cooperate in the process of porting numbers from one carrier to another so as to limit service outage for the ported subscriber.

3.1.1.1. For a Coordinated Cutover Environment, Sprint and Covad will coordinate the disconnect and switch translations as close to the requested time as possible. The coordination shall be pre-specified by Covad and agreed to by both parties and in no case shall begin more than thirty (30) minutes after the agreed upon time.

3.1.1.2. For a Non-Coordinated Cutover Environment, the Parties will agree to a mutually satisfactory cutover time and Sprint shall schedule an update of disconnect and switch translations at the agreed upon cutover time. Such updates will be available to Covad at Parity with Sprint's own availability for such activity. Sprint and Covad shall each provide an appropriate operations contact with whom the Parties can contact in the event manual intervention is needed to complete the cutover. In the event of manual intervention, and if Sprint is unable to resolve the issue within sixty (60) minutes, Sprint shall notify Covad of the issue and Covad and Sprint shall determine the plan to

resolve it.

- 3.2. Testing. Sprint and Covad shall cooperate in conducting Covad's testing to ensure interconnectivity between systems. Sprint shall inform Covad of any system updates that may affect the Covad network and Sprint shall, at Covad's request, perform tests to validate the operation of the network. Additional testing requirements may apply as specified by this Agreement.
- 3.3. Installation Timeframes
  - 3.3.1. Installation Time Frames for RCF INP, where no other work is required, will be completed using Sprint's standard interval for service installation of complex services.
  - 3.3.2. If a subscriber elects to move its Telephone Exchange Service back to Sprint while on an INP arrangement, Sprint shall notify Covad of the Subscriber's termination of service with Covad and the Subscriber's instructions regarding its telephone number(s) at Parity with what is offered to other Sprint customers.
- 3.4. Call Referral Announcements. Should Covad direct Sprint to terminate INP measures, Sprint shall allow Covad to order a referral announcement available in that switch.
- 3.5. Engineering and Maintenance. Sprint and Covad will cooperate to ensure that performance of trunking and signaling capacity is engineered and managed at levels which are at Parity with that provided by Sprint to its subscribers and to ensure effective maintenance testing through activities such as routine testing practices, network trouble isolation processes and review of operational elements for translations, routing and network fault isolation.
- 3.6. Operator Services and Directory Assistance
  - 3.6.1. With respect to operator services and directory assistance associated with INP for Covad subscribers, Sprint shall provide the following:
    - 3.6.1.1. While INP is deployed:
      - 3.6.1.1.1. Sprint shall allow Covad to order provisioning of Telephone Line Number (TLN) calling cards and Billed Number Screening (BNS), in its LIDB, for ported numbers, as specified by Covad. Sprint shall continue to allow Covad access to its LIDB. Other LIDB provisions are specified in this Agreement.
      - 3.6.1.1.2. Where Sprint has control of directory listings for NXX codes containing ported numbers, Sprint shall maintain entries for ported numbers as specified by Covad.
    - 3.6.2. Sprint OSS shall meet all requirements specified in "Generic Operator Services Switching Requirements for Number Portability," Issue 1.00, Final Draft, April 12, 1996. Editor - Nortel.

- 3.7. Number Reservation. When a subscriber ports to another service provider and has previously secured, via a tariffed offering, a reservation of line numbers from the donor provider for possible activation at some future point, these reserved but inactive numbers shall “port” along with the active numbers being ported by the subscriber in order to ensure that the end user subscriber will be permitted to expand its service using the same number range it could use if it remained with the donor provider. However, Sprint will not port vacant numbers.

**ATTACHMENT VI**  
**LOCAL NUMBER PORTABILITY**

**1. INTRODUCTION**

- 1.1. Upon implementation of LNP, both Parties agree to conform and provide such LNP pursuant to FCC regulations and compliance with the Industry Forum. To the extent consistent with the FCC and Industry rules as amended from time to time, the requirements for LNP shall include the following:
- 1.1.1. Subscribers must be able to change local service providers and retain the same telephone number(s) within the serving wire center utilizing the portability method in effect within the porting MSA, as offered by the porting carrier, and within the area of portability as defined by the FCC or state commission having jurisdiction over this Agreement.
  - 1.1.2. The LNP network architecture shall not subject Parties to any degradation of service in any relevant measure, including transmission quality, switching and transport costs, increased call set-up time and post-dial delay.
  - 1.1.3. Parties agree that when an NXX is defined as portable, it shall also be defined as portable in all LNP capable offices which have direct trunks to the given switch.
  - 1.1.4. When a subscriber ports to another service provider and has previously secured a reservation of line numbers from the donor provider for possible activation at some future point, these reserved but inactive numbers shall port along with the active numbers being ported by the subscriber only in states where appropriate charges from Sprint tariffs are executed for reserved numbers.
  - 1.1.5. NXX Availability. Not all NXXs in each CO may be available for porting.
  - 1.1.6. LERG Reassignment. Portability for an entire NXX shall be provided by utilizing reassignment of the NXX to Covad through the LERG.
  - 1.1.7. Coordination of service order work outside normal business hours (8:00AM to 5:00PM) shall be at requesting Party's expense. Premium rates will apply for service order work performed outside normal business hours, weekends, and holidays.
  - 1.1.8. Mass Calling Events. Parties will notify each other at least seven (7) days in advance where ported numbers are utilized. Parties will only port mass calling numbers using switch translations and a choke network for call routing. Porting on mass calling numbers will be handled outside the normal porting process and comply with any applicable state or federal regulatory requirements developed for mass calling numbers.

**2. TRANSITION FROM INP TO LNP**

- 2.1. Existing INP Arrangements. As Sprint provisions LNP according to the industry schedule in

a Wire Center/Central Office, there will be a maximum of a ninety (90) day transition from INP to LNP. At that time, Covad will be required to fully implement LNP according to industry standards.

- 2.2. Once LNP is available in an area, all new portability will be LNP and INP will no longer be offered.

### **3. TESTING**

- 3.1. An Interconnection Agreement (or Memorandum of Understanding, or Porting Agreement) detailing conditions for LNP must be in effect between the Parties prior to testing.
- 3.2. Testing and operational issues will be addressed in the implementation plans as described in Part A, Section 30 of the agreement.
- 3.3. Covad must be NPAC certified and have met Sprint testing parameters prior to activating LNP. If LNP implementation by a CLEC/CMRS provider occurs past the FCC activation date, testing and porting will be done at Covad's expense.
- 3.4. Parties will cooperate to ensure effective maintenance testing through activities such as routine testing practices, network trouble isolation processes and review of operational elements for translations, routing and network fault isolation.
- 3.5. Parties shall cooperate in testing performed to ensure interconnectivity between systems. All LNP providers shall notify each connected provider of any system updates that may affect the Covad or Sprint network. Each LNP provider shall, at each other's request, jointly perform tests to validate the operation of the network. Additional testing requirements may apply as specified by this Agreement or in the Implementation Plan.

### **4. ENGINEERING AND MAINTENANCE**

- 4.1. Each LNP provider will monitor and perform effective maintenance through testing and the performance of proactive maintenance activities such as routine testing, development of and adherence to appropriate network trouble isolation processes and periodic review of operational elements for translations, routing and network faults.
- 4.2. It will be the responsibility of the Parties to ensure that the network is stable and maintenance and performance levels are maintained in accordance with state commission requirements. It will be the responsibility of the Parties to perform fault isolation in their network before involving other providers.
- 4.3. Additional engineering and maintenance requirements shall apply as specified in this Agreement or the Implementation Plan.

### **5. E911/911**

- 5.1. When a subscriber ports to another service provider, the donor provider shall use information provided by the porting provider to update the 911 tandem switch routing tables and 911/ALI database to correctly route, and provide accurate information to PSAP call

centers.

- 5.2. Prior to implementation of LNP, the Parties agree to develop, implement, and maintain efficient methods to maintain 911 database integrity when a subscriber ports to another service provider. The Parties agree that the customer shall not be dropped from the 911 database during the transition.

## **6. BILLING**

- 6.1. When an IXC terminates an InterLATA or IntraLATA toll call to either party's local exchange customer whose telephone number has been ported from one party to the other, the parties agree that the party to whom the number has been ported shall receive revenues from those IXC access charges associated with end office switching, local transport, RIC, and CCL, as appropriate, and such other applicable charges. The party from whom the number has been ported shall be entitled only to receive any entrance facility fees, access tandem fees and appropriate local transport charges as set forth in this Agreement. Such access charge payments will be adjusted to the extent that the paying party has already paid Reciprocal Compensation for the same minutes of use. When a call for which access charges are not applicable is terminated to a party's local exchange customer whose telephone number has been ported from the other party, the parties agree that the Reciprocal compensation arrangements described in this Agreement shall apply.
- 6.2. Non-Payment. Customers lose the right to the ported telephone number upon non-payment of charges. Sprint will not port telephone numbers of customers who have bills in default.



**ATTACHMENT VII**  
**GENERAL BUSINESS REQUIREMENTS**

**1. PROCEDURES**

- 1.1. Contact with Subscribers, customers and end-users
  - 1.1.1. Each Party at all times shall be the primary contact and account control for all interactions with its subscribers, customers and end-users, except as specified by that Party. Subscribers, customers and end-users, include active subscribers, customers and end-users, as well as those for whom service orders are pending.
  - 1.1.2. Each Party shall ensure that any of its personnel who may receive subscriber, customers or end-users, inquiries, or otherwise have opportunity for subscriber contact from the other Party's subscribers, customers and end-users, regarding the other Party's services: (i) provide appropriate referrals to subscribers, customers and end-users, who inquire about the other Party's services or products; (ii) do not in any way disparage or discriminate against the other Party, or its products or services; and (iii) do not provide information about its products or services during that same inquiry or subscriber, customer or end-user contact.
  - 1.1.3. Sprint shall not use Covad's request for subscriber, customer or end-user information, order submission, or any other aspect of Covad's processes or services to aid Sprint's marketing or sales efforts.
- 1.2. Expedite and Escalation Procedures
  - 1.2.1. Sprint and Covad shall develop mutually acceptable escalation and expedite procedures which may be invoked at any point in the Service Ordering, Provisioning, Maintenance, and Subscriber Usage Data transfer processes to facilitate rapid and timely resolution of disputes. In addition, Sprint and Covad will establish intercompany contacts lists for purposes of handling subscriber, customer and end-user and other matters which require attention/resolution outside of normal business procedures within thirty (30) days after Covad's request. Each party shall notify the other party of any changes to its escalation contact list as soon as practicable before such changes are effective.
  - 1.2.2. No later than thirty (30) days after Covad's request Sprint shall provide Covad with contingency plans for those cases in which normal Service Ordering, Provisioning, Maintenance, Billing, and other procedures for Sprint's unbundled Network Elements, features, functions, and resale services are inoperable.
- 1.3. Subscriber of Record. Sprint shall recognize Covad as the Subscriber of Record for all Network Elements or services for resale ordered by Covad and shall send all notices, invoices, and information which pertain to such ordered services directly to Covad. Covad will provide Sprint with addresses to which Sprint shall send all such notices, invoices, and information.

## 1.4. Service Offerings

- 1.4.1. Sprint shall provide Covad with access to new services, features and functions concurrent with Sprint's notice to Covad of such changes, if such service, feature or function is installed and available in the network or as soon thereafter as it is installed and available in the network, so that Covad may conduct market testing.
- 1.4.2. Essential Services. For purposes of service restoral, Sprint shall designate a Covad access line as an Essential Service Line (ESL) at Parity with Sprint's treatment of its own subscribers and applicable state law or regulation, if any.
- 1.4.3. Blocking Services. Upon request from Covad, employing Sprint-approved LSR documentation, Sprint shall provide blocking of 700, 900, and 976 services, or other services of similar type as may now exist or be developed in the future, and shall provide Billed Number Screening (BNS), including required LIDB updates, or equivalent service for blocking completion of bill-to-third party and collect calls, on a line, PBX, or individual service basis. Blocking shall be provided the extent (a) it is an available option for the Telecommunications Service resold by Covad, or (b) it is technically feasible when requested by Covad as a function of unbundled Network Elements.
- 1.4.4. Training Support. Sprint shall provide training, on a non-discriminatory basis, for all Sprint employees who may communicate, either by telephone or face-to-face, with Covad subscribers. Such training shall include compliance with the branding requirements of this Agreement including without limitation provisions of forms, and unbranded "Not at Home" notices.

## 2. ORDERING AND PROVISIONING

- 2.1. Ordering and Provisioning Parity. Sprint shall provide necessary ordering and provisioning business process support as well as those technical and systems interfaces as may be required to enable Covad to provide the same level and quality of service for all resale services, functions, features, capabilities and unbundled Network Elements at Parity.
- 2.2. National Exchange Access Center (NEAC)
  - 2.2.1. Sprint shall provide a NEAC or equivalent which shall serve as Covad's point of contact for all activities involved in the ordering and provisioning of Sprint's unbundled Network Elements, features, functions, and resale services.
  - 2.2.2. The NEAC shall provide to Covad a nationwide telephone number (available from 6:00 a.m. to 8:00 p.m. Eastern Standard Time, Monday through Friday, and 8:00 am through 5:00 P.M. Eastern Standard Time on Saturday) answered by competent, knowledgeable personnel and trained to answer questions and resolve problems in connection with the ordering and provisioning of unbundled Network Elements (except those associated with local trunking interconnection), features, functions, capabilities, and resale services.

- 2.2.3. Sprint shall provide, as requested by Covad, through the NEAC, provisioning and premises visit installation support in the form of coordinated scheduling, status, and dispatch capabilities during Sprint's standard business hours and at other times as agreed upon by the parties to meet subscriber demand.
- 2.3. Street Address Guide (SAG). Within thirty (30) days of Covad's written request, Sprint shall provide to Covad the SAG data, or its equivalent, in an electronic format mutually agreeable to the parties. All changes and updates to the SAG shall be provided to in a mutually agreed format and timeframe.
- 2.4. CLASS and Custom Features. Where generally available in Sprints serving area, Covad, at the tariff rate, may order the entire set of CLASS, CENTREX and Custom features and functions, or a subset of any one of such features.
- 2.5. Number Administration/Number Reservation
  - 2.5.1. Sprint shall provide testing and loading of Covad's NXX on the same basis as Sprint provides itself or its affiliates. Further, Sprint shall provide Covad with access to abbreviated dialing codes, , and the ability to obtain telephone numbers, including vanity numbers, while a subscriber is on the phone with Covad. When Covad uses numbers from a Sprint NXX, Sprint shall provide the same range of number choices to Covad, including choice of exchange number, as Sprint provides its own subscribers. Reservation and aging of Sprint NXX's shall remain Sprint's responsibility.
  - 2.5.2. In conjunction with an order for service, Sprint shall accept Covad orders for vanity numbers and blocks of numbers for use with complex services including, but not limited to, DID, CENTREX, and Hunting arrangements, as requested by Covad.
  - 2.5.3. For simple services number reservations and aging of Sprint's numbers, Sprint shall provide real-time confirmation of the number reservation when the Electronic Interface has been implemented. For number reservations associated with complex services, Sprint shall provide confirmation of the number reservation within twenty-four (24) hours of Covad's request. Consistent with the manner in which Sprint provides numbers to its own subscribers, no telephone number assignment is guaranteed until service has been installed.
- 2.6. Service Order Process Requirements
  - 2.6.1. Service Migrations and New Subscriber Additions
    - 2.6.1.1. For resale services, other than for a Covad order to convert "as is" a Covad subscriber, Sprint shall not disconnect any subscriber service or existing features at any time during the migration of that subscriber to Covad service without prior Covad agreement.
    - 2.6.1.2. For services provided through UNEs, Sprint shall recognize Covad as an agent, in accordance with OBF developed processes, for the subscriber, customer or end-user in coordinating the disconnection of services provided

by another CLEC or Sprint. Sprint shall re-use existing facilities of Covad end-users by transferring existing facilities to Covad as UNEs when Covad's UNE order represents the change of the end user's local service to Covad. In addition, Sprint and Covad will work cooperatively to minimize service interruptions during the conversion.

2.6.1.3. Unless otherwise directed by Covad and when technically capable, when Covad orders resale Telecommunications Services or UNEs all trunk or telephone numbers currently associated with existing services shall be retained without loss of feature capability and without loss of associated ancillary services including, but not limited to, Directory Assistance and 911/E911 capability.

2.6.1.4. For subscriber conversions requiring coordinated cut-over activities, on a per order basis, Sprint, to the extent resources are readily available, and Covad will agree on a scheduled conversion time, which will be a designated time period within a designated date.

2.6.1.4.1. Any request made by Covad to coordinate conversions after normal working hours, or on Saturday's or Sunday's or Sprint holidays shall be performed at Covad's expense.

2.6.1.5. A general Letter of Agency (LOA) initiated by Covad or Sprint will be required to process a PLC or PIC change order. Providing the LOA, or a copy of the LOA, signed by the end user will not be required to process a PLC or PIC change ordered by Covad or Sprint. Covad and Sprint agree that PLC and PIC change orders will be supported with appropriate documentation and verification as required by FCC and Commission rules. In the event of a subscriber complaint of an unauthorized PLC record change where the Party that ordered such change is unable to produce appropriate documentation and verification as required by FCC and Commission rules (or, if there are no rules applicable to PLC record changes, then such rules as are applicable to changes in long distance carriers of record), such Party shall be liable to pay and shall pay all nonrecurring and/or other charges associated with reestablishing the subscriber's local service with the original local carrier.

2.6.2. Intercept Treatment and Transfer Service Announcements. Sprint shall provide unbranded intercept treatment and transfer of service announcements to Covad's subscribers. Sprint shall provide such treatment and transfer of service announcement in accordance with local tariffs and as provided to similarly situated Sprint subscribers for all service disconnects, suspensions, or transfers.

2.6.3. Due Date

2.6.3.1. Sprint shall supply Covad with due date intervals to be used by Covad personnel to determine service installation dates.

- 2.6.3.2. Sprint shall use best efforts complete orders by the Covad requested DDD within agreed upon intervals.
- 2.6.4. Subscriber Premises Inspections and Installations
  - 2.6.4.1. Covad shall perform or contract for all Covad's needs assessments, including equipment and installation requirements required beyond the Demarcation/NID, located at the subscriber premises.
  - 2.6.4.2. Sprint shall provide Covad with the ability to schedule subscriber premises installations at the same morning and evening commitment level of service offered Sprint's own customers. The parties shall mutually agree on an interim process to provide this functionality during the implementation planning process.
- 2.6.5. Firm Order Confirmation (FOC)
  - 2.6.5.1. Sprint shall provide to Covad, a Firm Order Confirmation (FOC) for each Covad order. The FOC shall contain the appropriate data elements as defined by the OBF standards.
  - 2.6.5.2. For a revised FOC, Sprint shall provide standard detail as defined by the OBF standards.
  - 2.6.5.3. Sprint shall provide to Covad the date that service is scheduled to be installed.
- 2.6.6. Order Rejections
  - 2.6.6.1. Sprint shall reject and return to Covad any order that Sprint cannot provision, due to technical reasons, missing information, or jeopardy conditions resulting from Covad ordering service at less than the standard order interval. When an order is rejected, Sprint shall, in its reject notification, specifically describe all of the reasons for which the order was rejected. Before rejecting the order Sprint shall review the entire order and identify all possible reasons for rejection. Complete reject notices will be sent to Covad in the same intervals as FOC..
- 2.6.7. Service Order Changes
  - 2.6.7.1. In no event will Sprint change a Covad initiated service order without a new service order directing said change. If an installation or other Covad ordered work requires a change from the original Covad service order in any manner, Covad shall initiate a revised service order. If requested by Covad, Sprint shall then provide Covad an estimate of additional labor hours and/or materials.
    - 2.6.7.1.1. When a service order is completed, the cost of the work performed will be reported promptly to Covad.

- 2.6.7.2. If a Covad subscriber requests a service change at the time of installation or other work being performed by Sprint on behalf of Covad, Sprint, while at the subscriber premises, shall direct the Covad subscriber to contact Covad, and Covad will initiate a new service order.
- 2.7. Network Testing. Sprint shall perform all its standard pre-service testing prior to the completion of the service order.
- 2.8. Service Suspensions/Restorations. Upon Covad's request through an Industry Standard, OBF, Suspend/Restore Order, or mutually agreed upon interim procedure, Sprint shall suspend or restore the functionality of any Network Element, feature, function, or resale service to which suspend/restore is applicable. Sprint shall provide restoration priority on a per network element basis in a manner that conforms with any applicable regulatory Rules and Regulations or government requirements.
- 2.9. Order Completion Notification. Upon completion of the requests submitted by Covad, Sprint shall provide to Covad a completion notification in an industry standard, OBF, or in a mutually agreed format. The completion notification shall include detail of the work performed, to the extent this is defined within OBF guidelines, and in an interim method until such standards are defined.
- 2.10. Specific Unbundling Requirements. Covad may order and Sprint shall provision unbundled Network Elements. However, it is Covad's responsibility to combine the individual network elements should it desire to do so.
- 2.11. Systems Interfaces and Information Exchanges
- 2.11.1. General Requirements
- 2.11.1.1. Sprint shall provide to Covad Electronic Interface(s) for transferring and receiving information and executing transactions for all business functions directly or indirectly related to Service Ordering and Provisioning of Network Elements, features, functions and Telecommunications Services. The Interface(s) shall be developed/designed for the transmission of data from Covad to Sprint, and from Sprint to Covad.
- 2.11.1.2. Interim interfaces or processes may be modified, if so agreed by Covad and Sprint, during the interim period.
- 2.11.1.3. Until the Electronic Interface is available, Sprint agrees that the NEAC or similar function will accept Covad orders. Orders will be transmitted to the NEAC via an interface or method agreed upon by Covad and Sprint.
- 2.11.2. For any Covad subscriber Sprint shall provide, subject to applicable rules, orders, and decisions, Covad with access CPNI without requiring Covad to produce a signed LOA, based on Covad's blanket representation that subscriber has authorized Covad to obtain such CPNI.
- 2.11.2.1. The preordering Electronic Interface includes the provisioning of CPNI

from Sprint to Covad. The Parties agree to execute a LOA agreement with the Sprint end user prior to requesting CPNI for that Sprint end user, and to request end user CPNI only when the end user has specifically given permission to receive CPNI. The Parties agree that they will conform to FCC and/or state regulations regarding the provisioning of CPNI between the parties, and regarding the use of that information by the requesting party.

- 2.11.2.2. The requesting Party will document end user permission obtained to receive CPNI, whether or not the end user has agreed to change local service providers. For end users changing service from one party to the other, specific end user LOAs may be requested by the Party receiving CPNI requests to investigate possible slamming incidents, and for other reasons agreed to by the Parties.
- 2.11.2.3. The receiving Party may also request documentation of an LOA if CPNI is requested and a subsequent service order for the change of local service is not received. On a schedule to be determined by Sprint, Sprint will perform a comparison of requests for CPNI to service orders received for the change of Local Service to Covad. Sprint will produce a report of unmatched requests for CPNI, and may require an LOA from Covad for each unmatched request. Covad agrees to provide evidence of end user permission for receipt of CPNI for all end users in the request by Sprint within three (3) business days of receipt of a request from Sprint. Should Sprint determine that there has been a substantial percentage of unmatched LOA requests, Sprint reserves the right to immediately disconnect the preordering Electronic Interface.
- 2.11.2.4. If Covad is not able to provide the LOA for ninety-five percent (95%) of the end users requested by Sprint, or if Sprint determines that an LOA is inadequate, Covad will be considered in breach of the agreement. Covad can cure the breach by submitting to Sprint evidence of an LOA for each inadequate or omitted LOA within three (3) business days of notification of the breach.
- 2.11.2.5. Should Covad not be able to cure the breach in the timeframe noted above, Sprint will discontinue processing new service orders until, in Sprint's determination, Covad has corrected the problem that caused the breach.
- 2.11.2.6. Sprint will resume processing new service orders upon Sprint's timely review and acceptance of evidence provided by Covad to correct the problem that caused the breach.
- 2.11.2.7. If Covad and Sprint do not agree that Covad requested CPNI for a specific end user, or that Sprint has erred in not accepting proof of an LOA, the Parties may immediately request dispute resolution in accordance with Part B. Sprint will not disconnect the preordering Electronic Interface during the Alternate Dispute Resolution process.
- 2.11.2.8. When available per Electronic Interface Implementation Plan, Sprint shall

provide to Covad Electronic Interface to Sprint information systems to allow Covad to assign telephone number(s) (if the subscriber does not already have a telephone number or requests a change of telephone number) at Parity.

2.11.2.9. When available per Electronic Interface Implementation Plan, Sprint shall provide to Covad an Electronic Interface to schedule dispatch and installation appointments at Parity.

2.11.2.10. When available per Electronic Interface Implementation Plan, Sprint shall provide to Covad an Electronic Interface to Sprint subscriber information systems which will allow Covad to determine if a service call is needed to install the line or service at Parity.

2.11.2.11. When available per Electronic Interface Implementation Plan, Sprint shall provide to Covad an Electronic Interface to Sprint information systems which will allow Covad to provide service availability dates at Parity.

2.11.2.12. When available per Electronic Interface Implementation Plan, Sprint shall provide to Covad an Electronic Interface which transmits status information on service orders at Parity. Until an Electronic Interface is available, Sprint agrees that Sprint will provide proactive status on service orders at the following critical intervals: acknowledgment, firm order confirmation, and completion according to interim procedures to be mutually developed.

## 2.12. Standards

2.12.1. General Requirements. Covad and Sprint shall agree upon the appropriate ordering and provisioning codes to be used for UNEs. These codes shall apply to all aspects of the unbundling of that element and shall be known as data elements as defined by the Telecommunications Industry Forum Electronic Data Interchange Service Order Subcommittee (TCIF-EDI-SOSC).

## 3. BILLING

- 3.1. Sprint shall comply with various industry, OBF, and other standards referred to throughout this Agreement. Sprint will review any changes to industry standards, and implement the changes within the industry-defined window. Sprint will notify Covad of any deviations to the standards.
- 3.2. Sprint shall bill Covad for each service supplied by Sprint to Covad pursuant to this Agreement at the rates set forth in this Agreement.
- 3.3. Sprint shall provide to Covad a single point of contact for interconnection at the National Access Service Center (NASC), and Network Elements and resale at Sprint's NEAC, to handle any Connectivity Billing questions or problems that may arise during the implementation and performance of the terms and conditions of this Agreement.
- 3.4. Sprint shall provide a single point of contact for handling of any data exchange questions or problems that may arise during the implementation and performance of the terms and



conditions of this Agreement.

- 3.5. Subject to the terms of this Agreement, Covad shall pay Sprint within thirty (30) days from the Bill Date. If the payment due date is a Saturday, Sunday or has been designated a bank holiday payment shall be made the next business day.
- 3.6. Billed amounts for which written, itemized disputes or claims have been filed shall be handled in accordance with the procedures set forth in Part B, Article 21 of this Agreement.
- 3.7. Sprint will assess late payment charges to Covad in accordance with Part B, § 5.5 of this Agreement.
- 3.8. Sprint shall credit Covad for incorrect Connectivity Billing charges including without limitation: overcharges, services ordered or requested but not delivered, interrupted services, services of poor quality and installation problems if caused by Sprint. Sprint will include a payment of interest in accordance with Part B, §5.6. Such reimbursements shall be set forth in the appropriate section of the Connectivity Bill pursuant to CABS, or SECAB standards.
- 3.9. Where Parties have established interconnection, Sprint and the Covad agree to conform to MECAB and MECOD guidelines. They will exchange Billing Account Reference and Bill Account Cross Reference information and will coordinate Initial Billing Company/Subsequent Billing Company billing cycles. Sprint and Covad will exchange the appropriate records to bill exchange access charges to the IXC. Sprint and Covad agree to capture EMI records for inward terminating and outward originating calls and send them to the other, as appropriate, in daily or other agreed upon interval, via and agreed upon media (e.g.: Connect Direct, cartridge or magnetic tape).
- 3.10. Revenue Protection. Sprint shall make available to Covad, at Parity with what Sprint provides to itself, its Affiliates and other local telecommunications carriers, all present and future fraud prevention or revenue protection features, including prevention, detection, or control functionality embedded within any of the Network Elements. These features include, but are not limited to screening codes, information digits assigned such as information digits '29' and '70' which indicate prison and COCOT pay phone originating line types respectively, call blocking of domestic, international, 800, 888, 900, NPA-976, 700, 500 and specific line numbers, and the capability to require end-user entry of an authorization code for dial tone. Sprint shall, when technically capable and consistent with the implementation schedule for Operations Support Systems (OSS), additionally provide partitioned access to fraud prevention, detection and control functionality within pertinent OSS.

#### **4. PROVISION OF SUBSCRIBER USAGE DATA**

- 4.1. This Article 4 sets forth the terms and conditions for Sprint's provision of Recorded Usage Data (as defined in this Attachment VIII) to Covad and for information exchange regarding long distance billing. The parties agree to record call information for interconnection in accordance with this Article 4. To the extent technically feasible, each party shall record all call detail information associated with completed calls originated by or terminated to the other Party's local exchange subscriber. Sprint shall record for Covad the messages that

Sprint records for and bills to its end users. These records shall be provided at a party's request and shall be formatted pursuant to Bellcore's EMI standards and the terms and conditions of this Agreement. These records shall be transmitted to the other party on non-holiday business days in EMI format via CDN, or provided on a cartridge or magnetic tape. Sprint and Covad agree that they shall retain, at each party's sole expense, copies of all EMI records transmitted to the other party for at least forty-five (45) calendar days after transmission to the other party.

#### 4.2. General Procedures

4.2.1. Sprint shall comply with various industry and OBF standards referred to throughout this Agreement.

4.2.2. Sprint shall comply with OBF standards when recording and transmitting Usage Data.

4.2.3. Sprint shall record all usage originating from Covad subscribers using resold services ordered by Covad, where Sprint records those same services for Sprint subscribers. Recorded Usage Data includes, but is not limited to, the following categories of information:

4.2.3.1. Use of CLASS/LASS/Custom Features that Sprint records and bills for its subscribers on a per usage basis.

4.2.3.2. Calls to Information Providers (IP) reached via Sprint facilities will be provided in accordance with § 4.2.7.

4.2.3.3. Calls to Directory Assistance where Sprint provides such service to a Covad subscriber.

4.2.3.4. Calls completed via Sprint-provided Operator Services where Sprint provides such service to Covad's local service subscriber and where Sprint records such usage for its subscribers using Industry Standard Bellcore EMI billing records.

4.2.3.5. For Sprint-provided Centrex Service, station level detail.

4.2.4. Retention of Records. Sprint shall maintain a machine readable back-up copy of the message detail provided to Covad for a minimum of forty-five (45) calendar days. During the forty-five (45) day period, Sprint shall provide any data back-up to Covad upon the request of Covad. If the forty-five (45) day has expired, Sprint may provide the data back-up at Covad's expense.

4.2.5. Sprint shall provide to Covad Recorded Usage Data for Covad subscribers. Sprint shall not submit other Covad local usage data as part of the Covad Recorded Usage Data.

4.2.6. Sprint shall not bill directly to Covad subscribers any recurring or non-recurring charges for Covad's services to the subscriber except where explicitly permitted to do so within a written agreement between Sprint and Covad.

- 4.2.7. Sprint will record 976/N11 calls and transmit them to the IP for billing. Sprint will not bill these calls to either the Covad or the Covad's end user.
- 4.2.8. Sprint shall provide Recorded Usage Data to Covad billing locations as agreed to by the Parties.
- 4.2.9. Sprint shall provide a single point of contact to respond to Covad call usage, data error, and record transmission inquiries.
- 4.2.10. Sprint shall provide Covad with a single point of contact and remote identifiers (IDs) for each sending location.
- 4.2.11. Covad shall provide a single point of contact responsible for receiving usage transmitted by Sprint and receiving usage tapes from a courier service in the event of a facility outage.
- 4.2.12. Sprint shall bill and Covad shall pay the charges for Recorded Usage Data. Billing and payment shall be in accordance with the applicable terms and conditions set forth herein.

#### 4.3. Charges

- 4.3.1. Access services, including revenues associated therewith, provided in connection with the resale of services hereunder shall be the responsibility of Sprint and Sprint shall directly bill and receive payment on its own behalf from an IXC for access related to interexchange calls generated by resold or rebranded customers.
- 4.3.2. Sprint will be responsible for returning EMI records to IXCs with the proper EMI Return Code along with the Operating Company Number (OCN) of the associated ANI, (i.e., Billing Number).
- 4.3.3. Sprint will deliver a monthly statement for wholesale services in the medium (e.g.: NDM, paper, diskette, cartridge, magnetic tape, or CD-ROM) requested by Covad as follows:
  - 4.3.3.1. Invoices will be provided in a standard Carrier Access Billing format or other such format as Sprint may determine;
  - 4.3.3.2. Where local usage charges apply and message detail is created to support available services, the originating local usage at the call detail level in standard EMI industry format will be exchanged daily or at other mutually agreed upon intervals, and Covad will pay Sprint for providing such call detail;
  - 4.3.3.3. The Parties will work cooperatively to exchange information to facilitate the billing of in and out collect and inter/intra-region alternately billed messages;
  - 4.3.3.4. Sprint agrees to provide information on the end-user's selection of special features where Sprint maintains such information (e.g.: billing

method, special language) when Covad places the order for service;

4.3.3.5. Monthly recurring charges for Telecommunications Services sold pursuant to this Agreement shall be billed monthly in advance.

4.3.3.6. Sprint shall bill for message provisioning and, if applicable data tape charges, related to the provision of usage records. Sprint shall also bill Covad for additional copies of the monthly invoice.

4.3.4. For billing purposes, and except as otherwise specifically agreed to in writing, the Telecommunications Services provided hereunder are furnished for a minimum term of one month. Each month is presumed to have thirty (30) days.

#### 4.4. Central Clearinghouse & Settlement

4.4.1. Sprint and Covad shall agree upon Clearinghouse and Incollect/Outcollect procedures.

4.4.2. Sprint shall settle with Covad for both intra-region and inter-region billing exchanges of calling card, bill-to-third party, and collect calls under separately negotiated settlement arrangements.

#### 4.5. Lost Data

4.5.1. Loss of Recorded Usage Data. Covad Recorded Usage Data determined to have been lost, damaged or destroyed as a result of an error or omission by Sprint in its performance of the recording function shall be recovered by Sprint at no charge to Covad. In the event the data cannot be recovered by Sprint, Sprint shall estimate the messages and associated revenue, with assistance from Covad, based upon the method described below. This method shall be applied on a consistent basis, subject to modifications agreed to by Sprint and Covad. This estimate shall be used to adjust amounts Covad owes Sprint for services Sprint provides in conjunction with the provision of Recorded Usage Data.

4.5.2. Partial Loss. Sprint shall review its daily controls to determine if data has been lost. When there has been a partial loss, actual message and minute volumes shall be reported, if possible through recovery as discussed in 4.1.4.1 above. Where actual data are not available, a full day shall be estimated for the recording entity, as outlined in the following paragraphs. The amount of the partial loss is then determined by subtracting the data actually recorded for such day from the estimated total for such day.

4.5.3. Complete Loss. When Sprint is unable to recover data as discussed in 4.1.4.1 above estimated message and minute volumes for each loss consisting of an entire AMA tape or entire data volume due to its loss prior to or during processing, lost after receipt, degaussed before processing, receipt of a blank or unreadable tape, or lost for other causes, shall be reported.

4.5.4. Estimated Volumes. From message and minute volume reports for the entity

experiencing the loss, Sprint shall secure message/minute counts for the four (4) corresponding days of the weeks preceding that in which the loss occurred and compute an average of these volumes. Sprint shall apply the appropriate average revenue per message (“arpm”) agreed to by Covad and Sprint to the estimated message volume for messages for which usage charges apply to the subscriber to arrive at the estimated lost revenue.

- 4.5.5. If the day of loss is not a holiday but one (1) (or more) of the preceding corresponding days is a holiday, use additional preceding weeks in order to procure volumes for two (2) non-holidays in the previous two (2) weeks that correspond to the day of the week that is the day of the loss
- 4.5.6. If the loss occurs on a weekday that is a holiday (except Christmas and Mother’s day), Sprint shall use volumes from the two (2) preceding Sundays.
- 4.5.7. If the loss occurs on Mother’s day or Christmas day, Sprint shall use volumes from that day in the preceding year multiplied by a growth factor derived from an average of Covad’s most recent three (3) month message volume growth. If a previous year’s message volumes are not available, a settlement shall be negotiated.

#### 4.6. Testing, Changes and Controls

- 4.6.1. The Recorded Usage Data, EMI format, content, and transmission process shall be tested as agreed upon by Covad and Sprint.
- 4.6.2. Control procedures for all usage transferred between Sprint and Covad shall be available for periodic review. This review may be included as part of an Audit of Sprint by Covad or as part of the normal production interface management function. Breakdowns which impact the flow of usage between Sprint and Covad must be identified and jointly resolved as they occur. The resolution may include changes to control procedures, so similar problems would be avoided in the future. Any changes to control procedures would need to be mutually agreed upon by Covad and Sprint.
- 4.6.3. Sprint Software Changes
  - 4.6.3.1. When Sprint plans to introduce any software changes which impact the format or content structure of the usage data feed to Covad, designated Sprint personnel shall notify Covad no less than ninety (90) calendar days before such changes are implemented.
  - 4.6.3.2. Sprint shall communicate the projected changes to Covad’s single point of contact so that potential impacts on Covad processing can be determined.
  - 4.6.3.3. Covad personnel shall review the impact of the change on the entire control structure. Covad shall negotiate any perceived problems with Sprint and shall arrange to have the data tested utilizing the modified software if required.

- 4.6.3.4. If it is necessary for Sprint to request changes in the schedule, content or format of usage data transmitted to Covad, Sprint shall notify Covad.
- 4.6.4. Covad Requested Changes:
  - 4.6.4.1. Covad may submit a purchase order to negotiate and pay for changes in the content and format of the usage data transmitted by Sprint.
  - 4.6.4.2. When the negotiated changes are to be implemented, Covad and/or Sprint shall arrange for testing of the modified data.
- 4.7. Information Exchange and Interfaces
  - 4.7.1. Product/Service Specific. Sprint shall provide a Bellcore standard 42-50-01 miscellaneous charge record to support the Special Features Star Services if these features are part of Sprint's offering and are provided for Sprint's subscribers on a per usage basis.
  - 4.7.2. Rejected Recorded Usage Data
    - 4.7.2.1. Upon agreement between Covad and Sprint, messages that cannot be rated and/or billed by Covad may be returned to Sprint via CDN or other medium as agreed by the Parties. Returned messages shall be sent directly to Sprint in their original EMI format utilizing standard EMI return codes.
    - 4.7.2.2. Sprint may correct and resubmit to Covad any messages returned to Sprint. Sprint will not be liable for any records determined by Sprint to be billable to a Covad end user. Covad will not return a message that has been corrected and resubmitted by Sprint. Sprint will only assume liability for errors and unguideables caused by Sprint.

## **5. GENERAL NETWORK REQUIREMENTS**

- 5.1. Sprint shall provide repair, maintenance and testing for all resold Telecommunications Services and such UNEs that Sprint is able to test, in accordance with the terms and conditions of this Agreement.
- 5.2. During the term of this Agreement, Sprint shall provide necessary maintenance business process support as well as those technical and systems interfaces at Parity. Sprint shall provide Covad with maintenance support at Parity.
- 5.3. Sprint shall provide on a regional basis, a point of contact for Covad to report vital telephone maintenance issues and trouble reports twenty four (24) hours and seven (7) days a week.
- 5.4. Sprint shall provide Covad maintenance dispatch personnel on the same schedule that it provides its own subscribers.
- 5.5. Sprint shall cooperate with Covad to meet maintenance standards for all Telecommunications Services and unbundled network elements ordered under this Agreement. Such maintenance standards shall include, without limitation, standards for

testing, network management, call gapping, and notification of upgrades as they become available.

- 5.6. All Sprint employees or contractors who perform repair service for Covad subscribers shall follow Sprint standard procedures in all their communications with Covad subscribers. These procedures and protocols shall ensure that:
  - 5.6.1. Sprint employees or contractors shall perform repair service that is equal in quality to that provided to Sprint subscribers; and
  - 5.6.2. Trouble calls from Covad shall receive response time priority that is equal to that of Sprint subscribers and shall be handled on a “first come first served” basis regardless of whether the subscriber is a Covad subscriber or a Sprint subscriber.
- 5.7. Sprint shall provide Covad with scheduled maintenance for resold lines, including, without limitation, required and recommended maintenance intervals and procedures, for all Telecommunications Services and network elements provided to Covad under this Agreement equal in quality to that currently provided by Sprint in the maintenance of its own network. Covad shall perform its own testing for UNEs.
- 5.8. Sprint shall give maximum advanced notice to Covad of all non-scheduled maintenance or other planned network activities to be performed by Sprint on any network element, including any hardware, equipment, software, or system, providing service functionality of which Covad has advised Sprint may potentially impact Covad subscribers.
- 5.9. Notice of Network Event. Each party has the duty to alert the other of any network events that can result or have resulted in service interruption, blocked calls, or negative changes in network performance.
  - 5.9.1.
- 5.10. On all misdirected calls from Covad subscribers requesting repair, Sprint shall provide such Covad subscriber with the correct Covad repair telephone number as such number is provided to Sprint by Covad. Once the Electronic Interface is established between Sprint and Covad, Sprint agrees that Covad may report troubles directly to a single Sprint repair/maintenance center for both residential and small business subscribers, unless otherwise agreed to by Covad.
- 5.11. Upon establishment of an Electronic Interface, Sprint shall notify Covad via such electronic interface upon completion of trouble report. The report shall not be considered closed until such notification is made. Covad will contact its subscriber to determine if repairs were completed and confirm the trouble no longer exists.
- 5.12. Sprint shall perform all testing for resold Telecommunications Services.
- 5.13. Sprint shall provide test results to Covad, if appropriate, for trouble clearance. In all instances, Sprint shall provide Covad with the disposition of the trouble.
- 5.14. If Sprint initiates trouble handling procedures, it will bear all costs associated with that

activity. If Covad requests the trouble dispatch, and either there is no trouble found, or the trouble is determined to be beyond the end user demarcation point, then Covad will bear the cost.

## **6. MISCELLANEOUS SERVICES AND FUNCTIONS**

### **6.1. General**

6.1.1. To the extent that Sprint does not provide the services described in this Article 12 to itself, Sprint will use reasonable efforts to facilitate the acquisition of such services for or by Covad through the existing service provider. Covad must contract directly with the service provider for such services.

### **6.1.2. Basic 911 and E911 General Requirements**

6.1.2.1. Basic 911 and E911 provides a caller access to the appropriate emergency service bureau by dialing a 3-digit universal telephone number (911). Basic 911 and E911 access from Local Switching shall be provided to Covad in accordance with the following:

6.1.2.2. E911 shall provide additional routing flexibility for 911 calls. E911 shall use subscriber data, contained in the ALI/DMS, to determine to which PSAP to route the call.

6.1.2.3. Basic 911 and E911 functions provided to Covad shall be at Parity with the support and services that Sprint provides to its subscribers for such similar functionality.

6.1.2.4. Basic 911 and E911 access when Covad purchases Local Switching shall be provided to Covad in accordance with the following:

6.1.2.4.1. Sprint shall conform to all state regulations concerning emergency services.

6.1.2.4.2. For E911, Sprint shall use its service order process to update and maintain subscriber information in the ALI/DMS. Through this process, Sprint shall provide and validate Covad subscriber information resident or entered into the ALI/DMS.

6.1.2.4.3. Sprint shall provide for overflow 911 traffic to be routed to Sprint Operator Services or, at Covad's discretion, directly to Covad operator services.

6.1.3. Basic 911 and E911 access from the Covad local switch shall be provided to Covad in accordance with the following:

6.1.3.1. If required by Covad, Sprint, at Covad's sole expense, shall interconnect direct trunks from the Covad network to the E911 PSAP, or the E911



Tandems as designated by Covad. Such trunks may alternatively be provided by Covad.

6.1.3.2. In government jurisdictions where Sprint has obligations under existing agreements as the primary provider of the 911 System to the county (Host SPRINT), Covad shall participate in the provision of the 911 System as follows:

6.1.3.2.1. Each party shall be responsible for those portions of the 911 System for which it has control, including any necessary maintenance to each party's portion of the 911 System.

6.1.3.2.2. Host SPRINT shall be responsible for maintaining the E-911 database. Sprint shall be responsible for maintaining the E-911 routing database.

6.1.4. If a third party is the primary service provider to a government agency, Covad shall negotiate separately with such third party with regard to the provision of 911 service to the agency. All relations between such third party and Covad are totally separate from this Agreement and Sprint makes no representations on behalf of the third party.

6.1.5. If Covad or its Affiliate is the primary service provider to a government agency, Covad and Sprint shall negotiate the specific provisions necessary for providing 911 service to the agency and shall include such provisions in an amendment to this Agreement.

6.1.6. Interconnection and database access shall be priced as specified in Attachment I.

6.1.7. Sprint shall comply with established, competitively neutral intervals for installation of facilities, including any collocation facilities, diversity requirements, etc.

6.1.8. In a resale situation, where it may be appropriate for Sprint to update the ALI database, Sprint shall update such database with Covad data in an interval at Parity with that experienced by Sprint subscribers.

6.1.9. Sprint shall transmit to Covad daily all changes, alterations, modifications, and updates to the emergency public agency telephone numbers linked to all NPA NXX's. This transmission shall be electronic and be a separate feed from the subscriber listing feed.

6.1.10. Sprint shall provide to Covad the necessary UNEs for Covad to provide E911/911 services to government agencies. If such elements are not available from Sprint, Sprint shall offer E911/911 service for resale by Covad to government agencies.

6.1.11. The following are Basic 911 and E911 Database Requirements

6.1.11.1. The ALI database shall be managed by Sprint, but is the property of Sprint and Covad for those records provided by Covad.

- 6.1.11.2. To the extent allowed by the governmental agency, and where available, copies of the MSAG shall be provided within three business days from the time requested and provided on diskette, magnetic tape, or in a format suitable for use with desktop computers.
  - 6.1.11.3. Covad shall be solely responsible for providing Covad database records to Sprint for inclusion in Sprint's ALI database on a timely basis.
  - 6.1.11.4. Sprint and Covad shall arrange for the automated input and periodic updating of the E911 database information related to Covad end users. Sprint shall work cooperatively with Covad to ensure the accuracy of the data transfer by verifying it against the MSAG. Sprint shall accept electronically transmitted files or magnetic tape that conform to NENA Version #2 format.
  - 6.1.11.5. Covad shall assign an E911 database coordinator charged with the responsibility of forwarding Covad end user ALI record information to Sprint or via a third-party entity, charged with the responsibility of ALI record transfer. Covad assumes all responsibility for the accuracy of the data that Covad provides to Sprint.
  - 6.1.11.6. Covad shall provide information on new subscribers to Sprint within one (1) business day of the order completion. Sprint shall update the database within two (2) business days of receiving the data from Covad. If Sprint detects an error in the Covad provided data, the data shall be returned to Covad within two (2) business days from when it was provided to Sprint. Covad shall respond to requests from Sprint to make corrections to database record errors by uploading corrected records within two (2) business days. Manual entry shall be allowed only in the event that the system is not functioning properly.
  - 6.1.11.7. Sprint agrees to treat all data on Covad subscribers provided under this Agreement as confidential and to use data on Covad subscribers only for the purpose of providing E911 services.
  - 6.1.11.8. Sprint shall adopt use of a Covad Code (NENA standard five-character field) on all ALI records received from Covad. The Covad Code will be used to identify the Covad of record in LNP/INP configurations.
  - 6.1.11.9. Sprint shall identify which ALI databases cover which states, counties or parts thereof, and identify and communicate a Point of Contact for each.
- 6.1.12. The following are basic 911 and E911 Network Requirements
- 6.1.12.1. Sprint, at Covad's option, shall provide a minimum of two (2) E911 trunks per 911 switching entity, or that quantity which will maintain P.01 transmission grade of service, whichever is the higher grade of service. Where applicable these trunks will be dedicated to routing 911 calls from Covad's switch to a Sprint selective router.

- 6.1.12.2. Sprint shall provide the selective routing of E911 calls received from Covad's switching office. This includes the ability to receive the ANI of Covad's subscriber, selectively route the call to the appropriate PSAP, and forward the subscriber's ANI to the PSAP. Sprint shall provide Covad with the appropriate CLLI codes and specifications regarding the Tandem serving area associated addresses and meet-points in the network.
- 6.1.12.3. Covad shall ensure that its switch provides an eight-digit ANI consisting of an information digit and the seven-digit exchange code. Covad shall also ensure that its switch provides the line number of the calling station. Where applicable, Covad shall send a ten-digit ANI to Sprint when there is an ANI failure the Covad shall send the Central Office Trunk Group number in the Emergency Service Central Office (ESCO) format.
- 6.1.12.4. Each ALI discrepancy report shall be jointly researched by Sprint and Covad. Corrective action shall be taken immediately by the responsible party.
- 6.1.12.5. Where Sprint controls the 911 network, Sprint should provide Covad with a detailed written description of, but not limited to, the following information:
  - 6.1.12.5.1. Geographic boundaries of the government entities, PSAPs, and exchanges as necessary.
  - 6.1.12.5.2. LECs rate centers/exchanges, where "Rate Center" is defined as a geographically specified area used for determining mileage dependent rates in the Public Switched Telephone Network.
  - 6.1.12.5.3. Technical specifications for network interface, Technical specifications for database loading and maintenance.
  - 6.1.12.5.4. Sprint shall identify special routing arrangements to complete overflow.
  - 6.1.12.5.5. Sprint shall begin restoration of E911 and/or E911 trunking facilities immediately upon notification of failure or outage. Sprint must provide priority restoration of trunks or networks outages on the same terms/conditions it provides itself and without the imposition of Telecommunications Service Priority (TSP).
  - 6.1.12.5.6. Repair service shall begin immediately upon receipt of a report of a malfunction. Repair service includes testing and diagnostic service from a remote location, dispatch of or in-person visit(s) of personnel. Technicians will be dispatched without delay.

- 6.1.12.6. Sprint shall identify any special operator-assisted calling requirements to support 911.
- 6.1.12.7. Trunking shall be arranged to minimize the likelihood of central office isolation due to cable cuts or other equipment failures. There will be an alternate means of transmitting a 911 call to a PSAP in the event of failures.
- 6.1.12.8. Circuits shall have interoffice, loop and Covad system diversity when such diversity can be achieved using existing facilities. Circuits will be divided as equally as possible across available Covad systems. Diversity will be maintained or upgraded to utilize the highest level of diversity available in the network.
- 6.1.12.9. All 911 trunks must be capable of transmitting and receiving Baudot code or ASII necessary to support the use of Telecommunications Devices for the Deaf (TTY/TDDs).

#### 6.1.13. Basic 911 and E911 Additional Requirements

- 6.1.13.1. All Covad lines that have been ported via INP shall reach the correct PSAP when 911 is dialed. Sprint shall send both the ported number and the Covad number (if both are received from Covad). The PSAP attendant shall see both numbers where the PSAP is using a standard ALI display screen and the PSAP extracts both numbers from the data that is sent.
- 6.1.13.2. Sprint shall work with the appropriate government agency to provide Covad the ten-digit POTS number of each PSAP which sub-tends each Sprint selective router/911 Tandem to which Covad is interconnected.
- 6.1.13.3. Sprint shall notify Covad 48 hours in advance of any scheduled testing or maintenance affecting Covad 911 service, and provide notification as soon as possible of any unscheduled outage affecting Covad 911 service.
- 6.1.13.4. Covad shall be responsible for reporting all errors, defects and malfunctions to Sprint. Sprint shall provide Covad with the point of contact for reporting errors, defects, and malfunctions in the service and shall also provide escalation contacts.
- 6.1.13.5. Covad may enter into subcontracts with third parties, including Covad Affiliates, for the performance of any of Covad's duties and obligations stated herein.
- 6.1.13.6. Sprint shall provide sufficient planning information regarding anticipated moves to SS7 signaling, for 911 services, for the next twelve (12) months.
- 6.1.13.7. Sprint shall provide notification of any impacts to the 911 services provided by Sprint to Covad resulting from of any pending Tandem moves, NPA splits, or scheduled maintenance outages, with enough time to react.
- 6.1.13.8. Sprint shall identify process for handling of "reverse ALI" inquiries by

public safety entities.

6.1.13.9. Sprint shall establish a process for the management of NPA splits by populating the ALI database with the appropriate new NPA codes.

## 6.2. Directory Assistance Service

6.2.1. Sprint shall provide for the routing of directory assistance calls (including but not limited to 411, 555-1212, NPA-555-1212) dialed by Covad subscribers directly to, at Covad's option, either (a) the Covad DA service platform to the extent Sprint's switch can perform this customized routing, or (b) Sprint DA service platform to the extent there is a DA service platform for that serving area.

6.2.2. Covad subscribers shall be provided the capability by Sprint to dial the same telephone numbers for access to Covad Directory Assistance that Sprint subscribers dial to access Sprint Directory Assistance.

6.2.3. Should Covad elect to resell Sprint Directory Assistance, Sprint shall provide Directory Assistance functions and services to Covad for its subscribers as described below.

6.2.3.1. Sprint agrees to provide Covad subscribers with the same Directory Assistance service available to Sprint subscribers.

6.2.3.2. Sprint shall notify Covad in advance of any changes or enhancements to its DA service, and shall make available such service enhancements on a non-discriminatory basis to Covad.

6.2.3.3. Sprint shall provide Directory Assistance to Covad subscribers in accordance with Sprint's internal local operator procedures and standards.

6.2.3.4. Sprint shall provide Covad with the same level of support for the provisioning of Directory Assistance as Sprint provides itself. Quality of service standards shall be measured at the aggregate level in accordance with standards and performance measurements that are at Parity with the standards and/or performance measurements that Sprint uses and/or which are required by law, regulatory agency, or by Sprint's own internal procedures, whichever are the most rigorous.

6.2.3.5. Service levels shall comply, at a minimum, with State Regulatory Commission requirements for number of rings to answer, and disaster recovery options.

6.2.3.6. Covad or its designated representatives may inspect any Sprint owned or sub-contracted office, which provides DA services, upon five (5) business days notice to Sprint.

6.2.3.7. Directory Assistance services provided by Sprint to Covad subscribers shall be branded in accordance with Part B, Article 10 of this Agreement.

- 6.2.3.8. Sprint shall provide the following minimum Directory Assistance capabilities to Covad's subscribers:
- 6.2.3.8.1. A maximum of two subscriber listings and/or addresses or Sprint Parity per Covad subscriber request.
  - 6.2.3.8.2. Telephone number and address to Covad subscribers upon request, except for non-published/unlisted numbers, in the same states where such information is provided to Sprint subscribers.
  - 6.2.3.8.3. Upon Covad's request, call completion to the requested number for local and intraLATA toll calls shall be sent to the network specified by Covad where such call completion routing is technically feasible. If fulfillment of such routing request is not technically feasible, Sprint shall promptly notify Covad if and when such routing becomes technically feasible. Rating and billing responsibility shall be agreed to by Covad and Sprint.
  - 6.2.3.8.4. Populate the Directory Assistance database in the same manner and in the same time frame as for Sprint subscribers.
  - 6.2.3.8.5. Any information provided by a Directory Assistance Automatic Response Unit (ARU) shall be repeated the same number of times for Covad subscribers as for Sprint's subscribers.
- 6.2.3.9. Sprint shall provide Covad call detail records in a mutually agreed format and manner.

### 6.3. Operator Services

- 6.3.1. Sprint shall provide for the routing of local operator services calls (including but not limited to 0+, 0-) dialed by Covad subscribers directly to either the Covad operator service platform or Sprint operator service platform to the extent Sprint's switch can perform this customized routing, as specified by Covad.
- 6.3.2. Covad subscribers shall be provided the capability by Sprint to dial the same telephone numbers to access Covad operator service that Sprint subscribers dial to access Sprint operator service.
- 6.3.3. Should Covad elect to resell Sprint Operator Services, Sprint shall provide Operator Services to as described below.
  - 6.3.3.1. Sprint agrees to provide Covad subscribers the same Operator Services available to Sprint subscribers. Sprint shall make available its service enhancements on a non-discriminatory basis.
  - 6.3.3.2. Operator Services provided to Covad subscribers shall be branded in accordance with Part B, Article 10 of this Agreement.

6.3.3.3. Sprint shall provide the following minimum Operator Service capabilities to Covad subscribers:

- 6.3.3.3.1. Sprint shall complete 0+ and 0- dialed local calls.
- 6.3.3.3.2. Sprint shall complete 0+ intraLATA toll calls.
- 6.3.3.3.3. Sprint shall complete calls that are billed to a 0+ access calling card.
- 6.3.3.3.4. Sprint shall complete person-to-person calls.
- 6.3.3.3.5. Sprint shall complete collect calls.
- 6.3.3.3.6. Sprint shall provide the capability for callers to bill to a third party and complete such calls.
- 6.3.3.3.7. Sprint shall complete station-to-station calls.
- 6.3.3.3.8. Sprint shall process emergency calls.
- 6.3.3.3.9. Sprint shall process Busy Line Verify and Busy Line Verify and Interrupt requests.
- 6.3.3.3.10. To the extent not prohibited by law or regulation, Sprint shall process emergency call trace.
- 6.3.3.3.11. Sprint shall process operator-assisted directory assistance calls.
- 6.3.3.3.12. Sprint shall provide basic rate quotes, subject to Sprint's operator systems being capable to perform unique rating for Covad.
- 6.3.3.3.13. Sprint shall process time-and-charges requests, at Parity with Sprint's own service offerings.
- 6.3.3.3.14. Sprint shall route 0- traffic directly to a "live" operator team.
- 6.3.3.3.15. When requested by Covad, Sprint shall provide instant credit on operator services calls as provided to Sprint subscribers or shall inform Covad subscribers to call an 800 number for Covad subscriber service to request a credit. Sprint shall provide one 800 number for business subscribers and another for residential subscribers.

- 6.3.3.3.16. Caller assistance for the disabled shall be provided in the same manner as provided to Sprint subscribers.
- 6.3.3.3.17. When available, Sprint shall provide operator-assisted conference calling.
- 6.3.4. Operator Service shall provide Covad's local usage rates when providing rate quote and time-and-charges services, and subject to the provisions described herein.
- 6.3.5. Operator Service shall adhere to equal access requirements.
- 6.3.6. Sprint shall exercise the same level of fraud control in providing Operator Service to Covad that Sprint provides for its own operator service.
- 6.3.7. Sprint shall query for Billed Number Screening restrictions when handling Collect, Third Party, and Calling Card Calls, both for station to station and person to person call types.
- 6.3.8. Sprint shall provide at an aggregate level for the operator service center, service measurements and accounting reports to Covad at Parity with the service measurements and accounting reports Sprint provides itself.
- 6.3.9. Covad or its designated representatives may inspect any Sprint owned or sub-contracted office, which provides Operator Services, upon five (5) business days notice to Sprint.
- 6.3.10. Sprint shall direct Covad subscriber account and other similar inquiries to the subscriber service center designated by Covad.
- 6.3.11. Sprint shall provide call records in accordance with Article 4 of this Attachment VIII.
- 6.3.12. Sprint shall accept and process overflow 911 traffic routed from Covad to the underlying platform used to provide Operator Service where such overflow is performed by Sprint for its subscribers.
- 6.3.13. Sprint shall engineer its BLV/BLVI facilities to accommodate the anticipated volume of BLV/BLVI requests during the Busy Hour. Covad may, from time to time, provide its anticipated volume of BLV/BLVI requests to Sprint. In those instances when the BLV/BLVI systems and databases become unavailable, Sprint shall promptly inform Covad.
- 6.4. Directory Assistance and Listings Service Requests
  - 6.4.1. These requirements pertain to Sprint's DA and Listings Service Request process that enables Covad to (a) submit Covad subscriber information for inclusion in Sprint Directory Assistance and Directory Listings databases; (b) submit Covad subscriber information for inclusion in published directories; and (c) provide Covad subscriber delivery address information to enable Sprint to fulfill directory distribution obligations.



- 6.4.2. When implemented by the Parties, Sprint shall accept orders on a real-time basis via electronic interface in accordance with OBF Directory Service Request standards within three (3) months of the effective date of this Agreement. In the interim, Sprint shall create a standard format and order process by which Covad can place an order with a single point of contact within Sprint.
- 6.4.3. Sprint will provide to Covad the following Directory Listing Migration Options, valid under all access methods, including but not limited to, Resale, UNEs and Facilities-Based:
  - 6.4.3.1. Migrate with no Changes. Retain all white page listings for the subscriber in both DA and DL. Transfer ownership and billing for white page listings to Covad.
  - 6.4.3.2. Migrate with Additions. Retain all white page listings for the subscriber in both DA and DL. Incorporate the specified additional listings order. Transfer ownership and billing for the white page listings to Covad.
  - 6.4.3.3. Migrate with Deletions. Retain all white page listings for the subscriber in both DA and DL. Delete the specified listings from the listing order. Transfer ownership and billing for the white page listings to Covad.
  - 6.4.3.4. To ensure accurate order processing, Sprint or its directory publisher shall provide to Covad the following information, with updates promptly upon changes:
    - 6.4.3.4.1. A matrix of NXX to central office;
    - 6.4.3.4.2. Geographical maps if available of Sprint service area;
    - 6.4.3.4.3. A description of calling areas covered by each directory, including but not limited to maps of calling areas and matrices depicting calling privileges within and between calling areas;
    - 6.4.3.4.4. Listing format rules;
    - 6.4.3.4.5. Standard abbreviations acceptable for use in listings and addresses;
    - 6.4.3.4.6. Titles and designations; and
    - 6.4.3.4.7. A list of all available directories and their Business Office close dates
- 6.4.4. Based on changes submitted by Covad, Sprint shall update and maintain directory assistance and directory listings data for Covad subscribers who:

- 6.4.4.1. Disconnect Service;
  - 6.4.4.2. Change CLEC;
  - 6.4.4.3. Install Service;
  - 6.4.4.4. Change any service which affects DA information;
  - 6.4.4.5. Specify Non-Solicitation; and
  - 6.4.4.6. Are Non-Published, Non-Listed, or Listed.
- 6.4.5. Sprint shall not charge for storage of Covad subscriber information in the DA and DL systems.
- 6.4.6. Covad shall not charge for storage of Sprint subscriber information in the DA and DL systems.
- 6.5. Directory Listings General Requirements. Covad acknowledges that many directory functions including but not limited to yellow page listings, enhanced white page listings, information pages, directory proofing, and directory distribution are not performed by Sprint but rather are performed by and are under the control of the directory publisher. Covad acknowledges that for a Covad subscriber's name to appear in a directory, Covad must submit a Directory Service Request (DSR). Sprint shall use reasonable efforts to assist Covad in obtaining an agreement with the directory publisher that treats Covad at Parity with the publisher's treatment of Sprint.
- 6.5.1. This § 6.5.1 pertains to listings requirements published in the traditional white pages.
  - 6.5.2. Sprint shall include in its master subscriber system database all white pages listing information for Covad subscribers in Sprint territories where Covad is providing local telephone exchange services and has submitted a DSR.
  - 6.5.3. Sprint agrees to include one basic White pages listing for each Covad customer located within the geographic scope of its White Page directories, at no additional charge to Covad. A basic White Pages listing is defined as a customer name, address and either the Covad assigned number for a customer or the number for which number portability is provided, but not both numbers. Basic White Pages listings of Covad customers will be interfiled with listings of Sprint and other LEC customers.
  - 6.5.4. Covad agrees to provide Covad customer listing information, including without limitation directory distribution information, to Sprint, at no charge. Sprint will provide Covad with the appropriate format for provision of Covad customer listing information to Sprint. The parties agree to adopt a mutually acceptable electronic format for the provision of such information as soon as practicable. In the event OBF adopts an industry-standard format for the provision of such information, the parties agree to adopt such format.
  - 6.5.5. Sprint agrees to provide White Pages database maintenance services to Covad. Covad will be charged a Service Order entry fee upon submission of Service Orders

into Sprint's Service Order Entry (SOE) System, which will include compensation for such database maintenance services. Service Order entry fees apply when Service Orders containing directory records are entered into Sprint's SOE System initially, and when Service Orders are entered in order to process a requested change to directory records.

- 6.5.6. Covad customer listing information will be used solely for the provision of directory services, including the sale of directory advertising to Covad customers.
- 6.5.7. In addition to a basic White Pages listing, Sprint will provide, at the rates set forth in Attachment I of this Agreement, tariffed White Pages listings (e.g.: additional, alternate, foreign and non-published listings) for Covad to offer for resale to Covad's customers.
- 6.5.8. Sprint, or its directory publisher, agree to provide White Pages distribution services to Covad customers within Sprint's service territory at no additional charge to Covad. Sprint represents that the quality, timeliness, and manner of such distribution services will be at Parity with those provided to Sprint and to other Covad customers.
- 6.5.9. Sprint agrees to include critical contact information pertaining to Covad in the "Information Pages" of those of its White Pages directories containing information pages, provided that Covad meets criteria established by its directory publisher. Critical contact information includes Covad's business office number, repair number, billing information number, and any other information required to comply with applicable regulations, but not advertising or purely promotional material. Covad will not be charged for inclusion of its critical contact information. The format, content and appearance of Covad's critical contact information will conform to applicable Sprint directory publisher's guidelines and will be consistent with the format, content and appearance of critical contact information pertaining to all CLECs in a directory.
- 6.5.10. Sprint will accord Covad customer listing information the same level of confidentiality that Sprint accords its own proprietary customer listing information. Sprint shall ensure that access to Covad customer proprietary listing information will be limited solely to those of Sprint and Sprint's directory publisher's employees, agents and contractors that are directly involved in the preparation of listings, the production and distribution of directories, and the sale of directory advertising. Sprint will advise its own employees, agents and contractors and its directory publisher of the existence of this confidentiality obligation and will take appropriate measures to ensure their compliance with this obligation. Notwithstanding any provision herein to the contrary, the furnishing of White Pages proofs to a Covad that contains customer listings of both Sprint and Covad will not be deemed a violation of this confidentiality provision.
- 6.5.11. Sprint will sell or license Covad's customer listing information to any third parties unless Covad submits written requests that Sprint refrain from doing so. Sprint and Covad will work cooperatively to share any payments for the sale or license of Covad

customer listing information to third parties. Any payments due to Covad for its customer listing information will be net of administrative expenses incurred by Sprint in providing such information to third parties. The parties acknowledge that the release of Covad's customer listing to Sprint's directory publisher will not constitute the sale or license of Covad's customer listing information causing any payment obligation to arise pursuant to this § 6.5.11.

- 6.6. Other Directory Services. Sprint will exercise reasonable efforts to cause its directory publisher to enter into a separate agreement with Covad which will address other directory services desired by Covad as described in this § 6.6. Both parties acknowledge that Sprint's directory publisher is not a party to this Agreement and that the provisions contained in this § 6.6 are not binding upon Sprint's directory publisher.
- 6.6.1. Sprint's directory publisher will negotiate with Covad concerning the provision of a basic Yellow Pages listing to Covad customers located within the geographic scope of publisher's Yellow Pages directories and distribution of Yellow Pages directories to Covad customers.
- 6.6.2. Directory advertising will be offered to Covad customers on a nondiscriminatory basis and subject to the same terms and conditions that such advertising is offered to Sprint and other Covad customers. Directory advertising will be billed to Covad customers by directory publisher.
- 6.6.3. Directory publisher will use commercially reasonable efforts to ensure that directory advertising purchased by customers who switch their service to Covad is maintained without interruption.
- 6.6.4. Information pages, in addition to any information page or portion of an information page containing critical contact information as described above in § 6.5.9 may be purchased from Sprint's directory publisher, subject to applicable directory publisher guidelines, criteria, and regulatory requirements.
- 6.6.5. Directory publisher maintains full authority as publisher over its publishing policies, standards and practices, including decisions regarding directory coverage area, directory issue period, compilation, headings, covers, design, content or format of directories, and directory advertising sales.
- 6.7. Directory Assistance Data. This section refers to the residential, business, and government subscriber records used by Sprint to create and maintain databases for the provision of live or automated operator assisted Directory Assistance. Directory Assistance Data is information that enables telephone exchange CLECs to swiftly and accurately respond to requests for directory information, including, but not limited to name, address and phone numbers. Under the provisions of the Act and the FCC's Interconnection order, Sprint shall provide unbundled and non-discriminatory access to the residential, business and government subscriber records used by Sprint to create and maintain databases for the provision of live or automated operator assisted Directory Assistance. This access shall be provided under separate contract.

6.8. Systems Interfaces and Exchanges

6.8.1. Directory Assistance Data Information Exchanges and Interfaces

6.8.1.1. Subscriber List Information

6.8.1.1.1. Sprint shall provide to Covad, within sixty (60) days after the Approval Date of this Agreement, or at Covad's request, all published Subscriber List Information (including such information that resides in Sprint's master subscriber system/accounts master file for the purpose of publishing directories in any format as specified by the Act) via an electronic data transfer medium and in a mutually agreed to format, on the same terms and conditions and at the same rates that the Sprint provides Subscriber List Information to itself or to other third parties. All changes to the Subscriber List Information shall be provided to Covad pursuant to a mutually agreed format and schedule. Both the initial List and all subsequent Lists shall indicate for each subscriber whether the subscriber is classified as residence or business class of service.

6.8.1.1.2. Covad shall provide directory listings to Sprint pursuant to the directory listing and delivery requirements in the approved OBF format, at a mutually agreed upon timeframe. Other formats and requirements shall not be used unless mutually agreed to by the parties.

6.9. Listing Types

LISTED	The listing information is available for all directory requirements.
NON-LISTED	The listing information is available to all directory requirements, but the information does not appear in the published street directory.
NON-PUBLISHED	A directory service may confirm, by name and address, the presence of a listing, but the telephone number is not available. The listing information is not available in either the published directory or directory assistance.

**ATTACHMENT VIII**  
**REPORTING STANDARDS**

**1. GENERAL**

- 1.1. Sprint shall satisfy all service standards, intervals, measurements, specifications, performance requirements, technical requirements, and performance standards (Performance Standards) that are specified in this agreement or are required by law or regulation. In addition, Sprint's performance under this Agreement shall be provided to Covad will be at Parity with the performance Sprint provides itself for like service(s).

**2. PARITY AND QUALITY MEASUREMENTS**

- 2.1. Sprint will develop self-reporting capabilities comparing Sprint results with Covad results based on the earlier of Sprint's internal implementation of the capabilities for the state of Nevada, or the timeframe ordered by the Commission. For orders received electronically, such measures will include:
- 2.1.1. Percentage of Commitment Times Met - Service Order
    - Average FOC time
    - % of orders with jeopardy
    - % of orders with no facilities
    - Average provision interval from receipt of LSR to test and turn up
  - 2.1.2. Percentage of Commitment Times Met - Trouble Report
  - 2.1.3. Percent Repeated Trouble Reports
  - 2.1.4. Average Receive to Clear
  - 2.1.5. Percentage of Installed Orders without Repair in the first five (5) days
  - 2.1.6. Average time to respond to collocation request
  - 2.1.7. Average time to provide collocation cage
  - 2.1.8. % of time interface available
- 2.2. In the event Covad chooses to utilize the Sprint operator service platform the following measures will be implemented within six (6) months of the date of first use by Covad:
- 2.2.1. Average Operator Service Toll Answer Time; and
  - 2.2.2. Average Directory Assistance Answer Time.
- 2.3. All above measures will be implemented in a manner that is consistent with the current measures Sprint makes of its own performance.



## ATTACHMENT IX

### PHYSICAL COLLOCATION

1. Definitions. For the purposes of this Attachment, the following terms or phrases shall have the meaning set forth below:

- (2) "Cable Vault" or "Conduit Space-Fixed" shall mean a location on Sprint premises where facilities enter from the Outside Cable Duct and access the Inner Duct for internal distribution.
- (3) "Central Office Building" shall mean a structure (not including a controlled environment vault ("CEV")) housing telephone company equipment that is under the control of Sprint and for which Sprint has the obligation to grant access and/or occupation by third parties.
- (4) "Collocation Point of Termination" shall mean the physical demarcation point in a Central Office Building, agreed by Sprint and Covad, between Sprint facilities and Covad-provided facilities. Normally this demarcation point is in the collocation location. Sprint will provide the cable to Covad that terminates in the Covad collocation location.
- (5) "Date of Occupancy" shall mean the date on which Covad first occupies the collocation location pursuant to this Attachment.
- (6) "Inner Duct" or "Conduit Space-per-foot" shall mean any passage or opening in, on, under, over or through the Sprint Central Office Building cable or conduit systems.
- (8) "Outside Cable Duct" shall mean any space located outside the Sprint premises and owned by or under the control of Sprint through which Sprint runs its cable, conduit or other associated facilities.
- (9) "Premises" is defined as within the serving wire center and any adjacent vaults. (10) "Property" shall mean the Building along with any real estate owned, leased or controlled by Sprint and used by Sprint in any way relating to the Building.
- (11) "Tariffed Service" shall mean the interconnection of Covad's equipment and Sprint's equipment pursuant to the Sprint Access Service tariffs as filed with the FCC. Sprint will attempt to match the tariff, Agreement and FCC orders in a timely manner.

2. Scope of Physical Collocation.

- A. Subject to the terms and conditions hereinafter set forth, and subject to the terms of Sprint Local Telephone Companies Tariff F.C.C. 1, the Tariff terms being controlling, and in consideration of the payment by Covad of the physical collocation charges found in Sprint Local Telephone Companies Tariff F.C.C. No. 1, Sprint hereby grants to Covad, and Covad hereby accepts, a non-



exclusive license to gain access to and occupy collocation location, and to gain access to and to use the Cable Vault, Inner Duct and other associated facilities as may be necessary, for the sole and exclusive purpose of providing telecommunications service. Such service will be provided by installing, maintaining and operating such Covad equipment as Covad deems appropriate in the provision of its Telecommunications Services, which will interconnect with telecommunications services and facilities provided by Sprint. .

- B. Sprint represents that its Local Telephone Companies' Tariff F.C.C. No. 1 complies with all state and federal laws and regulations extant as of the execution of this Agreement. In the event state or federal regulations alter the rates, terms and conditions for the provision of physical collocation, Sprint shall modify its Local Telephone Companies Tariff F.C.C. No. 1 to incorporate all such alterations within such time period as the regulations themselves may require, or if not required, within ninety (90) days of the effective date of such regulations.
  - B. If a Covad occupies more than one collocation location within the Sprint premises, Covad may interconnect its equipment contained in the two separate collocation locations by the most efficient and economic means that is technically feasible in accordance with standard connection methods and procedures, sound engineering principles and safety concerns.
  - C. Covad may interconnect equipment or facilities in its collocation location(s) with equipment or facilities within another carrier's collocation location by the most efficient and economic means that is technically feasible in accordance with standard connection methods and procedures, sound engineering principles and safety concerns.
  - D. Covad shall not occupy or use the Premises, or permit the Premises to be occupied or used, for any purpose, act or thing, other than the provision of Telecommunications Services . If Sprint determines, that such purpose, act or thing: (i) is in violation of any public law, ordinance or governmental regulation; (ii) may be dangerous to persons or property; (iii) may invalidate or increase the amount of premiums for any insurance policy carried on the Building or covering its operation; or (iv) violates the terms of this License Sprint may suspend Covad operations in the relevant collocation location(s) subject to the dispute settlement mechanisms of this Agreement.
3. Condition of Proposed Collocation Location:. Covad will be afforded the opportunity to inspect the relevant premises upon making a collocation request to Sprint. Covad represents to Sprint that it will exercise the opportunity to inspect the premises and that, subject to the completion of any construction work requested by Covad which needs to be completed prior to the Date of Occupancy, Covad will inform Sprint within 20 days of the inspection of any deficiencies necessary to bring the collocation locations into full compliance with the obligations of Sprint under this Agreement.
4. Assignment. The right to occupy a collocation location is not assignable in part; any attempt to assign this License in part will be considered a material breach hereof. The right to occupy a collocation location is not assignable in whole by Covad without the prior written consent of Sprint, which consent shall not be unreasonably withheld; provided, however, that Covad may assign its right to occupy a collocation location in whole to a subsidiary or affiliate of Covad if such subsidiary or affiliate (i) agrees in writing to be bound by the terms of this Agreement, and (ii) provides Sprint with any and all evidence of its compliance with the terms hereof as would have been required of Covad had this

Agreement not been assigned, including, but not limited to, current certificates of insurance as required by Section 9 hereof. Any attempt to assign Covad's right to occupy a collocation location without such prior written consent shall be void and of no effect. Sprint's consent to any assignment of Covad's collocation location shall not be deemed a waiver of the need to obtain such consent as to any future assignment or of Sprint's right to withhold consent to such assignment. If Covad requests that Sprint consent to the assignment of Covad's right to occupy a collocation location, Covad shall pay all costs and expenses, including, but not limited to, reasonable attorneys' fees, of Sprint in evaluating, processing, documenting, administering and approving such assignment, whether or not the requested assignment is eventually approved.

In no event shall Covad's right to occupy a collocation location or any rights or privileges hereunder be an asset of Covad under any bankruptcy, insolvency or reorganization proceedings.

5. Use of Common Areas. Covad, its employees, agents and invitees shall have a non-exclusive right to use those portions of the common area of the Sprint premises as are designated by Sprint from time to time, including, but not limited to, the right to use rest rooms in proximity to Covad's collocation location(s), corridors and other access ways from the entrance to the Building, the collocation location(s), and the parking areas adjacent to the Building for vehicles of persons while working for or on behalf of Covad at the Covad's collocation location(s); provided, however, that Sprint shall have the right to reserve parking spaces for Sprint's exclusive use or use by other occupants of the Building. Sprint does not guarantee that there is or will be sufficient parking spaces in parking areas to meet Covad's needs. Sprint does not guarantee that restroom facilities or water will be available. All common areas shall remain under the exclusive control and management of Sprint, and Sprint shall have the right to change the level, location and arrangement of parking areas and other common areas as Sprint may deem necessary. Use of all common areas shall be subject to such reasonable rules and regulations as Sprint may from time to time impose.
6. Sprint's Services and Obligations. For the term of this Agreement, unless earlier terminated, Sprint shall furnish the following services:
  - A. Establishment of Collocation Enclosure. Prior to the occupancy of the collocation location by Covad, Sprint will establish a secure enclosure defining the location of the Covad's collocation location (the "Collocation Enclosure") if requested to do so by Covad.
  - B. Environmental Controls. Sprint shall furnish air conditioning and/or other environmental controls for the area in which the collocation location is located in a manner consistent with those provided elsewhere in the Building. Sprint shall furnish air conditioning and/or other environmental controls for Covad's collocation location(s) based on information provided by Covad to Sprint in its application which Covad hereby represents to Sprint is sufficient to allow the Covad installed equipment to function without risk of harm or damage to the collocation location(s), the Building or any equipment or facilities of Sprint or any other occupant of the Building.

If Covad locates equipment or facilities in its collocation location(s) which Sprint determines, in the exercise of its sole discretion, affect the temperature or other environmental conditions otherwise maintained by Sprint in the Building, Sprint reserves the right to provide and install supplementary air conditioning units or other environmental control devices in its premises, and the cost of providing, installing, operating and maintaining any such supplementary air conditioning units or other environmental control devices made necessary solely by Covad's equipment or facilities shall be paid by Covad to Sprint in an amount that is proportional to the environmental demands made by the equipment and facilities of Covad, Sprint, and other collocating carriers placed since the units and devices were last sized for the Premises.

If Covad equipment requires cooling capability in excess of that normally provided by Sprint for its own equipment, any required supplementary air conditioning required by Covad shall be paid by Covad to Sprint.

- C. Electricity. Electricity shall be provided by Sprint in sufficient amount to provide ordinary lighting, heating and air conditioning of the collocation location(s). In addition, Sprint shall provide one 15 amp, 110 volt A.C. power circuit for Covad's use. If Covad requires additional electric capacity, such capacity will be supplied by Sprint; provided, however, that the provision of such electricity shall be contingent upon Covad paying Sprint an additional fee, in an amount to be agreed upon by the parties for such additional electricity. Notwithstanding any other provision of this Agreement to the contrary, Sprint reserves the right to monitor Covad's use of electricity to determine if the electricity provided is sufficient to support the activity being carried out by the Covad at its collocation location(s). If Sprint, in the exercise of its sole discretion, determines that the electricity provided to the customer pursuant to this Section 6(c) is insufficient to support the activity being carried on by the Covad in its collocation location(s), Sprint may require the installation of additional electrical circuits to provide Covad with additional electricity and Covad shall reimburse Sprint for any expenses incurred in making such additional electrical circuits available to Covad collocation location(s) and providing such additional electricity.

Covad covenants and agrees that, absent Sprint willful misconduct or gross negligence, Sprint shall not be liable or responsible to Covad for any loss, damage or expense which Covad may sustain or incur if either the quality or character of electrical service is changed or is no longer suitable for Covad's requirements.

Covad covenants and agrees that its use of electric current shall never exceed the capacity of existing feeders to the Building or the Premises, when reviewed in conjunction with electrical usage of other occupants in the Building.

- D. Water. Sprint, where water is available for its own use, shall furnish running water from regular Building outlets for drinking, lavatory and toilet purposes drawn through fixtures installed by Sprint, for the non-exclusive use of Covad, Sprint and any other building occupant. Covad shall not waste or permit the waste of water.

- E. Fire Safety System. Subject to the provisions of Section 7(E) hereof, Sprint may furnish an existing Halon 1301 Fire Suppression System, or may, but is not obligated to, provide its equivalent, to provide fire protection in the Premises designed to comply with the National Fire Protection Association ("NFPA") 12A Standard on Halon 1301 Fire Extinguishing Systems or with NFPA standard 2001 dealing with alternative fire suppression agents. Sprint shall furnish fire and smoke detection systems designed to comply with the NFPA 72E Standard on Automatic Fire Detectors in effect as of the collocation date.

Stand alone fire extinguishers will be provided in and about the Building and the Premises by Sprint as required by applicable fire codes.

Sprint and Sprint's insurance carriers will perform regular inspections of fire protection systems, and Covad hereby agrees to provide Sprint and Sprint's insurance carriers access to its collocation location(s) for purposes of such inspections, via pass key or otherwise. Sprint agrees to provide Covad with notice of its intent to access Covad's Premises where, in Sprint's sole discretion, such notice is practicable; provided, however, that no failure of Sprint to give such notice will affect Sprint's right of access or impose any liability on Sprint. Sprint will, at its expense, maintain and repair the fire and smoke detection systems unless maintenance or repair is required due to the act or omission of Covad, its employees, agents or invitees, in which case Covad shall reimburse Sprint for the cost of such repair or replacement. If a Halon or alternative fire suppression system is in place, the Covad shall, if at fault, and at Sprint's option, replace Halon or other fire extinguishing material discharged as a result of Covad's act or omission. Covad shall have no duty to inspect fire protection systems outside its collocation location(s); provided, however, if Covad is aware of damage to the fire protection systems it shall promptly notify Sprint.

Covad is aware the Premises will contain a fire detection and may contain a fire suppression system. In the event of discharge, Sprint is relieved of all liability for damage to equipment or personal injury except in cases where such damage to equipment or personal injury is due to the gross negligence or willful misconduct of Sprint, its officers, agents or employees.

- F. Security Service. Sprint shall furnish Building and Property security in accordance with its normal business practices. Other than the locks on the entrances to any Covad collocation enclosures, Sprint shall provide no security specific to Covad's collocation location(s). Sprint shall not be liable to Covad or any other party for loss of or damage to Covad's collocation location(s) or Covad equipment by third parties unless Sprint has failed to provide Building and Property security in accordance with its normal business practices.
- G. Elevator Service. Sprint shall furnish passenger elevator service as necessary to reach Covad's collocation location(s) or common areas to which Covad has access pursuant to the terms of this Agreement 24 hours a day, seven days a week. Freight elevator service when used by Covad's contractors, employees or agents shall be provided at times reasonably satisfactory to Sprint.
- H. Repairs. Sprint shall, at its sole expense, except as hereinafter provided, provide repair and maintenance of heating, cooling and lighting equipment and regularly scheduled refurbishments

or decorating to Covad's collocation location(s), Building and Property, in a manner consistent with Sprint's normal business practices.

Sprint shall not be obligated to inspect Covad collocation location(s), make any repairs or perform any maintenance unless first notified of the need in writing by Covad. If Sprint shall fail to commence such repairs or maintenance within 20 days after written notification, provided that such delays are not caused by Covad, Covad's sole right and remedy shall be, after further notice to Sprint, to make such repairs or perform such maintenance and to deduct that cost and expenses from the physical collocation fees payable; provided, however, that the amount of such deduction shall not exceed the reasonable value of such repairs or maintenance.

Sprint shall, where practical, provide Covad with 24 hours prior notice before making repairs and/or performing maintenance relating to Covad collocation location(s); provided, however, that Sprint shall have no obligation to provide such notice if Sprint determines, in the exercise of its sole discretion, that such repair or maintenance must be done sooner in order to preserve the safety of the Building or Covad's collocation location(s), or if required to do so by any court or governmental authority. Work shall be completed during normal working hours or at other times identified by Sprint; provided, however, that Covad shall pay Sprint for overtime and for any other expenses incurred if such work is done during other than normal working hours at Covad's request. Covad shall have the right, at its sole expense, to be present during repair or maintenance of the Premises.

The cost of all repairs and maintenance performed by or on behalf of Sprint to Covad's collocation location(s) which are, in Sprint's reasonable judgment, beyond normal repair and maintenance, or are made necessary as a result of misuse or neglect by Covad or Covad's employees, invitees or agents, shall be paid by Covad to Sprint within 10 days after being billed for such repairs and maintenance by Sprint.

- I. Interruption of Services. Sprint reserves the right to stop any service when Sprint deems such stoppage necessary by reason of accident or emergency, or for repairs, improvements or otherwise; however, Sprint agrees to use its best efforts not to interfere with Covad's use of Premises. Sprint does not warrant that any service will be free from interruptions caused by labor controversies, accidents, inability to obtain fuel, water or supplies, governmental regulations, or other causes beyond the reasonable control of Sprint.

No such interruption of service shall be deemed an eviction or disturbance of Covad's use of its collocation location(s) or any part thereof, or render Sprint liable to Covad for damages, by abatement of Covad Fees or otherwise, except as set forth in the Tariff, or relieve Covad from performance of its obligations under this Agreement. Covad hereby waives and releases all other claims against Sprint for damages for interruption or stoppage of service.

Sprint shall have the right to reduce heat, light, water and power as required by any mandatory or voluntary conservation programs.

- J. Covad Right of Access. Subject to reasonable building rules and any applicable Security Arrangements, Covad shall have the right of entry 24 hours per day to the Building, common areas, Covad collocation location(s) and common cable space. Prior notification to Sprint may be required.

Sprint, at Covad's expense, may issue non-employee photo identification cards for each Covad employee or vendor. Temporary identification cards may otherwise be provided by Sprint for employees or agents, contractors and invitees of Covad who may require occasional access to the Premises.

Sprint may issue access cards, codes, or keys to Covad's listed employees or vendors where such systems are available and their use by Covad will not otherwise compromise building security.

Sprint reserves the right to close and keep locked all entrance and exit doors of the Building during hours Sprint may deem advisable for the adequate protection of the Building. Use of the Building at any time it is unattended by appropriate Sprint personnel, or on Sundays and state and federal or other holidays recognized by Sprint, or, if Covad's collocation location(s) is not fully segregated from areas of the building containing Sprint equipment, may result in Covad requiring security accompaniment and shall be subject to such reasonable rules and regulations as Sprint may from time to time prescribe.

## 7. Covad's Obligations.

- A. Access Right of Sprint. Covad will allow Sprint access to its collocation location(s) at all times, via pass key or otherwise, to allow Sprint to react to emergencies, to maintain the space (not including Covad's equipment), and to monitor compliance with the rules and regulations of the Occupational Health and Safety Administration or Sprint, or other regulations and standards including but not limited to those related to fire, safety, health, and environmental safeguards. Except in emergencies or unless Covad has waived such notice elsewhere in this Agreement, and if conditions permit, Sprint will provide Covad with notice of its intent to access Covad's collocation location(s), thereby providing Covad the option to be present at the time of access. Covad shall not attach, or permit to be attached, additional locks or similar devices to any door or window, nor change existing locks or the mechanism thereof.
- B. Inspection and Janitorial. Covad shall regularly inspect its collocation location(s) to ensure they are in good working condition. Covad shall promptly notify Sprint of any damage to its collocation location(s) or of the need to perform any repair or maintenance of the collocation location(s), fixtures and appurtenances (including hardware, heating, cooling, ventilating, electrical and other mechanical facilities in the collocation locations). Covad shall provide regular janitorial service to its collocation location(s) and keep the collocation location(s) clean and trash free.
- C. Security Arrangements. Covad agrees to abide by all of Sprint's security practices for non-Sprint employees with access to the Building, including, without limitation:

- (1) Covad will supply to Sprint, and update as changes occur, a list of its employees or approved vendors who require access to the Building. The list will include the social security numbers of all such individuals.
  - (2) Covad is responsible for returning identification and access cards, codes, or keys of its terminated employees or its employees who no longer require access to its collocation locations. All cards, codes, or keys must be returned upon termination of this Agreement. Unreturned or replacement cards, codes, or keys may be subject to a fee at the discretion of Sprint.
  - (3) Covad's employees, agents, invitees and vendors must display identification cards at all times.
  - (4) Covad will assist Sprint in validation and verification of identification of its employees, agents, invitees and vendors by providing a telephone contact available 24 hours a day, seven days a week to verify identification.
  - (5) In a manner consistent with Building regulations, Covad shall list all furniture, equipment and similar articles Covad desires to remove from its collocation locations or the Building and deliver a copy to Sprint and procure a removal permit from building security authorizing Building employees to permit such articles to be removed.
  - (6) Before leaving its collocation location(s) unattended, Covad shall close and securely lock any doors and windows and shut off unnecessary equipment in the collocation location(s). Any damage resulting from Covad's failure to do so shall be the responsibility of Covad.
  - (7) Covad shall post in a prominent location visible from the common Building area, the names and telephone numbers of emergency contact personnel along with names and telephone numbers of their superiors for 24 hour emergency use by Sprint. Covad shall promptly update this information as changes occur.
- D. Telephone. Covad shall, at its own expense, install and maintain regular business telephone service in its collocation location. Sprint will facilitate the provisioning of such service.
- E. Fire Protection Systems. Covad shall, with the prior written consent of Sprint, have the right to provide additional fire protection systems within its collocation location(s); provided, however, that Covad may not install or use sprinklers or carbon dioxide fire suppression systems within the Building or its collocation location(s). If any governmental bureau, department or organization or Sprint's insurance carrier requires that changes, modifications, or alterations be made to the fire protection system, or that additional stand alone fire extinguishing, detection or protection devices be supplied within Covad's collocation locations, such changes, modifications or additions shall be made by Sprint and Covad shall reimburse Sprint for the cost thereof. If any governmental bureau, department or organization or Sprint's insurance carrier requires that changes or modifications be made to the fire protection system or that additional stand alone fire extinguishing, detection or protection devices be supplied within that portion of the Building in

which Covad's collocation location(s) in general are located, such changes, modifications, or additions shall be made by Sprint and Covad shall reimburse Sprint for the cost thereof in the same proportion as the square footage of Covad's collocation location(s) as compared to the total square footage of all areas occupied by Sprint and other collocating carriers in the affected portion of the Building.

- F. Hazardous Materials. Covad shall identify and shall notify Sprint in writing of any Hazardous Materials Covad may bring onto the Property, and will provide Sprint copies of any inventories or other data provided to State Emergency Response Commissions ("SERCs"), Local Emergency Planning Committees ("LEPCs"), or any other governmental agencies if required by the Emergency Planning and Community Right to Know Act (41 U.S.C. 11001, et seq.). Covad, its agents and employees shall transport, store and dispose of Hazardous Materials in accordance with all applicable federal, state or local laws, ordinances, rules and regulations. Covad will promptly notify Sprint of any releases of Hazardous Materials and will copy Sprint on any notification of or correspondence with any governmental agency which may be required by any environmental law as a result of such release.

Covad shall provide Sprint copies of all Material Safety Data Sheets ("MSDSs") for materials or chemicals regulated under the OSHA Hazard Communication Standard (29 C.F.R. 1910.1200) that are brought onto the property. All such materials shall be labeled in accordance with 29 C.F.R. 1910.1200, and applicable state regulations if such regulations are more stringent.

If Sprint discovers that Covad has brought onto Sprint's Property Hazardous Materials without notification, or is storing or disposing of such materials in violation of any applicable environmental law, Sprint may, at Sprint's option and without penalty, remove such Hazardous Materials, terminate this License, or suspend performance hereunder. Covad shall be responsible for, without cost to Sprint, the complete remediation of any releases or other conditions caused by its storage, use or disposal of Hazardous Materials. Covad shall also be responsible for removing and disposing of all Hazardous Materials on its Premises at the termination of this Agreement.. If Sprint elects to terminate this License or discontinue the performance of services hereunder due to the storage, use or disposal of Hazardous Materials contrary to the terms of this License, Covad shall be responsible for all costs and expenses associated with such termination or suspension of service in addition to being responsible for any remedies available to Sprint for defaults under this Agreement.

Covad shall indemnify and hold harmless Sprint, its successors and assigns against, and in respect of, any and all damages, claims, losses, liabilities and expenses, including, without limitation, all legal, accounting, consulting, engineering and other expenses, which may be imposed upon, or incurred by, Sprint or asserted against Sprint by any other party or parties (including, without limitation, Sprint's employees and/or contractors and any governmental entity) arising out of, or in connection with, Covad's use, storage or disposal of Hazardous Materials.

For purposes of this Section, "Hazardous Materials" shall mean any toxic substances and/or hazardous materials or hazardous wastes (including, without limitation, asbestos) as defined in,



or pursuant to, the OSHA Hazard Communication Standard (29 CFR Part 1910, Subpart Z), the Resource Conservation and Recovery Act of 1976 (42 U.S.C. Section 6901, et seq.), or regulations adopted pursuant to those statutes, the Toxic Substances Control Act (15 U.S.C. Section 2601, et seq.), the Comprehensive Environmental Response, Compensation and Liability Act (42 U.S.C. Section 9601, et seq.) or any other federal, state or local environmental law, ordinance, rule or regulation. The provisions of this Section shall survive the termination, cancellation, modification or recession of this Agreement.

- G. Various Prohibited Uses. Covad shall not do or permit anything to be done upon its collocation location(s), or bring or keep anything thereon which is in violation of any federal, state or local laws or regulations (including environmental laws or regulations not previously described), or any rules, regulations or requirements of the local fire department, Fire Insurance Rating Organization, or any other similar authority having jurisdiction over the Building. Covad shall not do or permit anything to be done upon its collocation locations which may in any way create a nuisance, disturb, endanger, or otherwise interfere with the telecommunications services of Sprint, any other occupant of the Building, their patrons or customers, or the occupants of neighboring property, or injure the reputation of the Property.

Covad shall not, without the prior written consent of Sprint: (i) install or operate any lead-acid batteries, refrigerating, heating or air conditioning apparatus or carry on any mechanical business in its collocation location(s); (ii) use its collocation location(s) for housing, lodging or sleeping purposes; (iii) permit preparation or warming of food, presence of cooking or vending equipment, sale of food or smoking in its collocation location(s); or (iv) permit the use of any fermented, intoxicating or alcoholic liquors or substances in its collocation location(s) or permit the presence of any animals except those used by the visually impaired. Sprint may, in its sole discretion, withhold such consent, or impose any condition in granting it, and revoke its consent at will.

- H. Rules of Conduct. Covad, its employees, agents, contractors, and business invitees shall (i) comply with all rules and regulations which Sprint may from time to time adopt for the safety, environmental protection, care, cleanliness and/or preservation of the good order of the Building, the Property and Covad's collocation location(s) and its tenants and occupants, and (ii) comply, at its own expense, with all ordinances which are applicable to its collocation locations and with all lawful orders and requirements of any regulatory or law enforcement agency requiring the correction, prevention and abatement of nuisances in or upon its collocation location(s) during the Term of this License or any extension hereof.

- I. Alterations. Covad shall not make installations, structural alterations, or additions in or to its collocation location(s) without submitting plans and specifications to Sprint and securing the prior written consent of Sprint in each instance. Covad shall include in its plans information related to the impact on power or air conditioning requirements. Sprint's consent shall not be unreasonably withheld or unduly delayed for alterations to Covad's collocation locations that do not adversely affect the Building's appearance, value, structural strength and mechanical integrity. Such work shall be done at the sole expense of Covad.

All installations, alterations and additions shall be constructed in a good and workmanlike manner and only new and good grades of material shall be used, and shall comply with all insurance requirements, governmental requirements, and terms of this Agreement. Work shall be performed at such times and in such manner as to cause a minimum of interference with Sprint's transaction of business. Covad shall permit Sprint to inspect all construction operations within its collocation location(s) and to approve contractors not previously certified, which approval shall not be unreasonably withheld. If alterations are made by Covad's contractors, Covad shall furnish to Sprint prior to commencement thereof, any required building permits and certificates of insurance or performance bonds of Covad's contractors and sub-contractors. Any such insurance to be provided by Covad's contractors or sub-contractors shall provide for coverage in amounts not less than as required by Sprint of Covad under Section 9 of this Attachment. Upon completion of any installation, alteration or addition, contractor's affidavits and full and final waivers of lien covering all labor and material expended and used shall be furnished to Sprint. Covad and its contractors and sub-contractors shall hold Sprint harmless from all claims, costs, damages, liens and expenses which may arise out of or be connected in any way with installations, alterations or additions.

All installations, alterations and additions which take the form of fixtures, except trade fixtures, placed in the collocation location(s) by and at the expense of Covad or others shall become the property of Sprint, and shall remain upon and be surrendered with the collocation location(s). Upon termination of this Agreement, however, Sprint shall have the right to require Covad to remove such fixtures and installations, alterations or additions at Covad's expense, and to surrender the collocation location(s) in the same condition as it was prior to the making of any or all such improvements, reasonable wear and tear excepted.

All fixtures and other equipment to be used by Covad in, about or upon its collocation location(s) shall be subject to the prior written approval of Sprint, which shall not be unreasonably withheld.

- J. Fireproofing Policy. Covad shall not cut or drill into, drive nails or screws into, install conduit or wires, or in any way deface any part of the Building, outside or inside, without the prior written consent of Sprint. If Covad desires signal, communications, alarm or other utility or service connections installed or changed, the same shall be made by and at the expense of Covad. Sprint shall have the right of prior approval of such utility or service connections, and shall direct where and how all connections and wiring for such service shall be introduced and run. In all cases, in order to maintain the integrity of the Halon space for proper Halon concentration, and to ensure compliance with Sprint's fireproofing policy, any penetrations by Covad, whether in its collocation location(s), the Building or otherwise, shall be sealed as quickly as possible by Covad with Sprint-approved fire barrier sealants, or by Sprint at Covad's cost.
- K. Overload Any Floor. Covad shall not exceed the Uniformly Distributed Live Load Capacity.
- L. Signs. Covad shall not paint, display, inscribe or affix any sign, trademark, picture, advertising, notice, lettering or direction on any part of the outside or inside of the Building, or on its collocation location(s), without the prior written consent of Sprint except that Covad shall clearly

mark and delineate its collocation location(s) by signage and/or floor markings to avoid misidentification with equipment and facilities belonging to Sprint or other collocating carriers..

- M. Advertising. Covad shall not use the name of the Building or Sprint for any purpose other than that of a business address of Covad, or use any picture or likeness of the Building on any letterhead, envelope, circular, notice, or advertisement, without the prior written consent of Sprint.
  - N. Articles Sold. Covad shall not exhibit, sell or offer for sale, rent or exchange in its collocation location(s) or on the Property any article, thing or service except those ordinarily embraced within the use of the collocation location(s) specified in Section 2 of this Attachment without the prior written consent of Sprint.
  - O. Cleanliness and Obstruction of Public Areas. Covad shall not place anything or allow anything to be placed near the glass of any door, partition or window which Sprint determines is unsightly from outside the Premises; take or permit to be taken in or out of other entrances of the Building, or take or permit to be taken on any passenger elevators, any item normally taken through service entrances or elevators; or whether temporarily, accidentally, or otherwise, allow anything to remain in, place or store anything in, or obstruct in any way, any passageway, exit, stairway, elevator, or shipping platform. Covad shall lend its full cooperation to keep such areas free from all obstruction and in a clean and sightly condition, move all supplies, furniture and equipment directly to its collocation location(s) as soon as received, and move all such items and waste, other than waste customarily removed by employees of the Building.
  - P. Equipment Grounding. Covad equipment shall be connected to Sprint's grounding system.
  - Q. Representations and Warranties. Covad hereby represents and warrants that the information provided to Sprint in any application or other documentation relative to Covad's request for telecommunications facility interconnection and Sprint premises collocation as contemplated in this Attachment is and shall be true and correct, and that Covad has all necessary corporate and regulatory authority to conduct business as a telecommunications carrier. Any violation of this Section shall be deemed a material breach of this Agreement.
8. Rights Reserved to Sprint. Sprint shall have the following rights, and others not specifically excluded in this Attachment, exercisable without notice and without liability to Covad for damage or injury to property, person or business (all claims for damage being hereby released), and without effecting an eviction or disturbance of Covad's use or possession or giving rise to any claim for offsets, or abatement of rent:
- A. To change the name or street address of the Building;
  - B. To install and maintain signs on the exterior and interior of the Building or anywhere on the Property;

- C. To designate all sources furnishing sign painting and lettering, ice, mineral or drinking water, beverages, foods, towels, vending machines or toilet supplies used or consumed in the Premises;
- D. To have pass keys or access cards with which to unlock all doors in Covad's collocation location(s), excluding any Covad safes;
- E. To enter the Covad's collocation locations for the purposes of examining or inspecting same and of making such repairs or alterations as Sprint deems necessary for health and safety reasons. Covad hereby waives any claim for damage, injury, interference with Covad's business, any loss of occupancy or quiet enjoyment of the its collocation location(s), and any other loss occasioned by the exercise of Sprint's access rights, except in the event such damages result solely from the gross negligence or willful misconduct of Sprint.
- F. To use any means Sprint may deem proper to gain access to Covad's collocation location(s) in an emergency. Entry into the Covad collocation location(s) obtained by Sprint by any such means in an emergency shall not be deemed to be forcible or unlawful entry into or a detainment of or an eviction of Covad from its collocation location(s) or any portion thereof;
- G. If it becomes necessary in Sprint's reasonable judgment, and there are no other reasonable alternatives available, Sprint shall have the right, for good cause shown, and upon 30 days prior notice, to reclaim Covad's collocation location or any portion thereof, any Inner Duct, Outside Cable Duct, Cable Vault space or other Sprint-provided facility. In such cases, Sprint will reimburse Covad for reasonable direct costs and expenses in connection with such reclamation and use best efforts to provide Covad alternative facilities of identical functionality.
- H. To utilize the space within the Building in such a manner as will best enable it to fulfill its own service requirements and obligations owed to other carriers pursuant to federal statute and regulations;
- I. To require all persons entering or leaving the Building during such hours as Sprint may from time to time reasonably determine to identify themselves to a watchman by registration or otherwise and to establish their right to leave or enter, and to exclude or expel any solicitor or person at any time from Covad's collocation location(s) or the Property. Sprint assumes no responsibility and shall not be liable for any damage resulting from the admission or refusal to admit any authorized or unauthorized person to the Building, provided that such damage is not the result of gross negligence or willful misconduct on the part of Sprint;
- J. To approve the weight, size and location of safes, computers and all other heavy articles in and about the Covad collocation location(s) and the Building, and to require all such items and other office furniture and equipment to be moved in and out of the Building or collocation location(s) only at such times and in such a manner as Sprint shall direct and in all events at Covad's sole risk and responsibility;
- K. At any time, to decorate and to make, at its own expense, repairs, alterations, additions and improvements, structural or otherwise, in or to the Covad collocation location(s), the Property, or

any part thereof (including, without limitation, the permanent or temporary relocation of any existing facilities such as parking lots or spaces), and to perform any acts related to the safety, protection or preservation thereof, and during such operations to take into and through Covad collocation location(s) or any part of the Property all material and equipment required, and to close or suspend temporarily operation of entrances, doors, corridors, elevators or other facilities, provided that Sprint shall limit inconvenience or annoyance to Covad as reasonably possible under the circumstances and that Sprint use reasonable efforts to avoid hindering or disrupting the telecommunications services of Covad

- L. To do or permit to be done any work in Sprint premises external to the Covad collocation location(s) or the Property or any adjacent or nearby building, land, street or alley;
  - M. To grant to anyone the exclusive right to conduct any business or render any service on the Sprint premises, provided such exclusive right shall not operate to exclude Covad from the use expressly permitted by this Attachment, unless Sprint exercises its right to terminate a Covad collocation location(s). Interconnection Agreement
  - N. To close the Building at such reasonable times as Sprint may determine, subject to Covad's right to admittance under such reasonable regulations as shall be prescribed from time to time by Sprint;
  - O. If it becomes necessary in Sprint's reasonable judgment, and there are no other reasonable alternatives, to require Covad to move to equivalent space in the Sprint's premises upon receipt of sixty (60) days written notice from Sprint, in which event, Sprint shall pay all moving costs, and the collocation payments provided for herein shall remain the same;
  - P. To designate all spaces to be occupied by Covad's facilities under this Attachment in accordance with applicable federal statutes and regulations and in light of Covad's requests made prior to and following Covad's initial inspection of the premises; Sprint still reviewing
  - Q. To perform all work, using Sprint employees or contractors, necessary to ready the Premises for Covad's use pursuant to Covad's collocation request;
  - R. To exercise all other rights reserved by Sprint pursuant to the provisions of this Attachment; and
  - S. To inspect the installation of Covad equipment in the Covad's collocation location(s) prior to the connection of Covad facilities to the Sprint facilities.
9. Insurance. Covad shall carry insurance, at Covad's expense, insuring Covad and, except for worker's compensation, naming Sprint as additional insured and/or loss payee, as its interest may appear. Such insurance shall contain such terms and conditions, provide such coverages and exclusions and be written by such companies as Sprint shall, in the exercise of its reasonable discretion, find satisfactory. As of the Commencement Date, Covad shall maintain the following coverages in the following amounts; provided, however, that Sprint retains the right to require additional and/or different coverages and amounts for good cause shown during the period of Covad physical collocation:

- (1) Commercial general liability, occurrence form, in limits of not less than \$1,000,000 combined single limit for bodily injury, personal injury and property damage liability insurance to include coverage for products/completed operations and explosion, collapse and underground liability;
- (2) "All Risk" property insurance on a full replacement cost basis, insuring Covad's real and personal property situated on or within the Property. Covad may elect to insure business interruption and contingent business interruption, as it is agreed that Sprint has no liability for loss of profit or revenues should an interruption of service occur;
- (3) Business auto insurance, including all owned, non-owned and hired automobiles, in an amount of not less than \$1,000,000 combined single limit for bodily injury and property damage liability;
- (4) Worker's compensation insurance in accordance with statutory requirements, and employers' liability with a minimum amount of \$500,000 per accident; and
- (5) Umbrella or excess liability in an amount not less than \$5,000,000 per occurrence and aggregate to provide excess limits over all primary liability coverages.

The limits of the insurance policies obtained by Covad as required above shall in no way limit Covad's liability to Sprint should Covad be liable to Sprint under the terms of this Attachment or otherwise.

Covad shall furnish to Sprint a certificate or certificates of insurance, satisfactory in form and content to Sprint, evidencing that the above coverage is in force and has been endorsed to guarantee that the coverage will not be cancelled or materially altered without first giving at least 30 days prior written notice to Sprint.

All policies required of Covad shall contain evidence of the insurer's waiver of the right of subrogation against Sprint for any insured loss covered thereunder. All policies of insurance shall be written as primary policies and not contributing with or in excess of the coverage, if any, that Sprint may carry. Any other provisions contained in this Section or elsewhere in this Attachment notwithstanding, the amounts of all insurance required to be obtained by Covad shall not be less than an amount sufficient to prevent Sprint from becoming a co-insurer.

12. Partial Destruction. If the Covad collocation location(s) or a portion thereof sufficient to make the collocation location(s) substantially unusable shall be destroyed or rendered unoccupiable by fire or other casualty, Sprint may, at its option, terminate the license, restore the Covad's collocation location to its previous condition, or construct a new collocation location for Covad. If Sprint restores its premises, or constructs new premises, Sprint will take Covad's needs for space into account when restoring or constructing the premises. .

Notwithstanding any other provision of this Agreement to the contrary, if any casualty provision of this Attachment is the result of any act, omission or negligence of Covad, its agents, employees, contractors, licensees, customers or business invitees, unless Sprint otherwise elects, this License shall not terminate, and, if Sprint elects to make such repairs, Covad shall reimburse Sprint for the cost of such repairs, or Covad shall repair such damage, including damage to the Building and the area surrounding it, and the collocation fees shall not abate.

. If the building is damaged by fire or other casualty to the extent that portions are rendered unoccupiable, notwithstanding that Covad's collocation location(s) may be directly unaffected, Sprint may, at its election, terminate the License by giving written notice of its intent to terminate the License.

Notwithstanding any other provision of the License, Sprint shall not be liable for any repair or restoration until, and then only to the extent that, insurance proceeds are received.

13. Eminent Domain. If the Property, or any portion thereof which includes a substantial part of the Covad's collocation location(s), shall be taken or condemned by any competent authority for any public use or purpose, the Covad's physical collocation shall end upon, and not before, the date when the possession of the part so taken shall be required for such use or purpose. If any condemnation proceeding shall be instituted in which it is sought to take or damage any part of the Property, or if the grade of any street or alley adjacent to the Property is changed by any competent authority and such change of grade makes it necessary or desirable to remodel the Property to conform to the changed grade, Sprint shall have the right to terminate this License, or modify Covad's physical collocation in conformity with applicable federal and state regulations relating to collocation upon not less than 30 days notice. No money or other consideration shall be payable by Sprint to Covad for such termination or modification. Covad shall have no right to share in the condemnation award or in any judgment for damages caused by such eminent domain proceedings.
14. License Termination. At the termination of Covad's physical collocation by lapse of time or otherwise:
  - A. Surrender of Keys. Covad shall surrender all keys, access cards and Sprint-provided photo identification cards to its collocation locations and the Building to Sprint, and shall make known to Sprint the combination of all combination locks remaining on its collocation locations.
  - B. Vacate Premises. Covad shall remove its equipment from the Premises within 30 days.
  - C. Return of Premises. Covad shall return to Sprint the collocation location(s) and all equipment and fixtures of Sprint in as good a condition and state of repair as when Covad originally took possession, normal wear and tear or damage by fire or other casualty excepted. Covad shall be responsible to Sprint for the cost of any repairs that shall be made necessary by the acts or omissions of the Covad or of its agents, employees, contractors or business invitees. Sprint reserves the right to oversee Covad's withdrawal from the collocation location(s) and Covad agrees to comply with all directives of Sprint regarding the removal of equipment and restoration of the collocation location(s), including, without limitation, Sprint's directive to

return the collocation location(s) in other than its original condition on the Date of Occupancy; provided, however, that Covad shall not be responsible for placing the collocation location(s) in other than its original condition if to do so would put Covad to additional expense above and beyond that which would be necessary to return the collocation location(s) in its original condition.

- D. Removal of Additions. All installations, additions, hardware, non-trade fixtures and improvements, temporary or permanent, except movable furniture and equipment belonging to Covad, in or upon the Premises, whether placed there by Covad or Sprint, shall be Sprint's property and shall remain upon the collocation location(s), all without compensation, allowance or credit to Covad; provided, however, that if prior to such termination or within 10 days thereafter, Sprint so directs, Covad shall promptly remove the installations, additions, hardware, non-trade fixtures and improvements, placed in or upon the Premise by Covad, failing which Sprint may remove the same, and Covad shall, upon demand, pay to Sprint the cost of such removal and of any necessary restoration of the collocation location(s). No cable shall be removed from Inner Duct or Outside Cable Duct except as directed by Sprint.
- E. Property Presumed Abandoned. All fixtures, installations, and personal property belonging to Covad not removed from the Premises upon termination of physical collocation and not required by Sprint to have been removed as provided in this Attachment, shall be conclusively presumed to have been abandoned by Covad and title thereto shall pass to Sprint under this Attachment as if by a Bill of Sale.
- F. Delay of Surrender. If the collocation location(s) is not surrendered at the termination of the physical collocation, Covad shall indemnify Sprint against loss or liability resulting from delay by Covad in so surrendering the collocation location(s), including, without limitation, any claims made by any succeeding tenant founded on such delay.

16. Remedies of Sprint. All rights and remedies of Sprint herein enumerated shall be cumulative and none shall exclude any other right or remedy allowed by law.

- A. Surrender of Premises. Upon any termination of this Agreement, whether by lapse of time or otherwise, or upon any termination of Covad's right to possession without termination of this Agreement, Covad shall surrender possession and vacate the collocation location(s) within 30 days, and deliver possession thereof to Sprint, and hereby grant to Sprint full and free license to enter into and upon the collocation location in such event with or without process of law and to expel or remove Covad and to remove any and all property, without being deemed in any manner guilty of trespass, eviction or forcible entry or conversion of property, and without relinquishing any other right given to Sprint hereunder or by operation of law.
- E. Sale of Building or Change in Building Lease Terms. If the owner of the Building or Sprint sells, transfers or assigns any interest in the Building, or there is any material change in the Lease to which the Building is subject, and such sale, transfers assignment or material change in the Lease gives rise to an obligation which is inconsistent with this Agreement, Sprint's



performance under this Agreement shall be excused to the extent of the inconsistency. Sprint hereby agrees that it will use its reasonable efforts to avoid any such inconsistency including, but not limited to, providing for Covad's continued occupancy of its collocation locations in any such sale, transfer or assignment; provided, however, that this obligation shall in no way obligate Sprint to incur any out of pocket expenses in its efforts to avoid such inconsistencies.

17. Bankruptcy. If any voluntary or involuntary petition or similar pleading under any section or sections of any bankruptcy act shall be filed by or against Covad, or any voluntary or involuntary proceeding in any court or tribunal shall be instituted to declare Covad insolvent or unable to pay Covad's debts, or Covad makes an assignment for the benefit of its creditors, or a trustee or receiver is appointed for Covad or for the major part of Covad's property, Sprint may, if Sprint so elects but not otherwise, and with or without notice of such election or other action by Sprint, forthwith terminate this Agreement.
19. Asbestos. Covad is aware the Building in which the Premises is located may contain or have contained asbestos or asbestos containing building materials, and Covad hereby releases and agrees to hold Sprint harmless from any and all liability to Covad or any of its employees, agents or invitees as a result thereof. Covad acknowledges that it has a right to inspect Sprint premises after making a request for collocation and will inform Sprint of any unsatisfactory conditions within 20 days of such inspection..
20. Subordination. This Attachment shall at all times be subject and subordinate to the lien of any mortgage (which term shall include all security instruments) that may be placed on the collocation location and Covad agrees, upon demand, to execute any instrument as may be required to effectuate such subordination.