

ORIGINAL

1
2
3
4
5
6
7
8
9
10
11
12
13
14
15
16
17
18
19
20
21
22
23
24
25

BELLSOUTH TELECOMMUNICATIONS, INC.

DIRECT TESTIMONY OF W. KEITH MILNER

BEFORE THE FLORIDA PUBLIC SERVICE COMMISSION

DOCKET NO. 000731-TP

NOVEMBER 15, 2000

Q. PLEASE STATE YOUR NAME, YOUR BUSINESS ADDRESS, AND YOUR POSITION WITH BELLSOUTH TELECOMMUNICATIONS, INC. ("BELLSOUTH").

A. My name is W. Keith Milner. My business address is 675 West Peachtree Street, Atlanta, Georgia 30375. I am Senior Director - Interconnection Services for BellSouth. I have served in my present position since February 1996.

Q. PLEASE SUMMARIZE YOUR BACKGROUND AND EXPERIENCE.

A. My business career spans over 30 years and includes responsibilities in the areas of network planning, engineering, training, administration, and operations. I have held positions of responsibility with a local exchange telephone company, a long distance company, and a research and development company. I have extensive experience in all phases of telecommunications network planning, deployment, and operations in both the domestic and international arenas.

1 I graduated from Fayetteville Technical Institute in Fayetteville, North
2 Carolina, in 1970, with an Associate of Applied Science in Business
3 Administration degree. I later graduated from Georgia State University
4 in 1992 with a Master of Business Administration degree.

5

6 Q. HAVE YOU TESTIFIED PREVIOUSLY BEFORE ANY STATE PUBLIC
7 SERVICE COMMISSION?

8

9 A. I have previously testified before the state Public Service Commissions
10 in Alabama, Florida, Georgia, Kentucky, Louisiana, Mississippi, and
11 South Carolina, the Tennessee Regulatory Authority, and the North
12 Carolina Utilities Commission on the issues of technical capabilities of
13 the switching and facilities network introduction of new service
14 offerings, expanded calling areas, unbundling, and network
15 interconnection.

16

17 Q. WHAT IS THE PURPOSE OF YOUR TESTIMONY TODAY?

18

19 A. In my testimony, I will address the technical aspects of network related
20 issues which have been raised in the Petition for Arbitration filed by
21 AT&T Communications of the Southern States, Inc. and TCG South
22 Florida (collectively "AT&T") in this docket. Specifically, I will address
23 the following issues, in whole or in part: Issues 8, 13-14, 18-21, 23,
24 and 25.

25

1 **Issue 8: What terms and conditions, and what separate rates if any,**
2 **should apply for AT&T to gain access to and use BellSouth facilities to**
3 **serve multi-unit installations?**

4

5 Q. BEFORE YOU GET INTO THE DETAILS OF THE DISPUTE
6 EMBEDDED IN THIS ISSUE, CAN YOU BRIEFLY DESCRIBE THE
7 PHYSICAL PLANT WE WILL BE TALKING ABOUT?

8

9 A. This issue involves multi-tenant units, either high rise buildings or
10 multiple buildings on a campus or garden-type apartments. I want to
11 describe the loop that we use to serve these types of customers. For
12 simplicity, a metallic loop (that is, one that does not use equipment
13 referred to as Digital Loop Carrier) that connects to a customer located
14 in a high rise building can be thought of having several parts: loop
15 feeder, loop distribution, intra-building network cable (INC) (sometimes
16 referred to as "riser cable"), and network terminating wire (NTW). The
17 loop then terminates in a network interface device (NID). I will
18 describe each of these separate items on the following pages.

19

20 Q. PLEASE DISCUSS THE LOOP FEEDER YOU MENTIONED.

21

22 A. Loop feeder has been referred to as "the first mile" of the loop in that it
23 is the first section of cable leaving the BellSouth central office headed
24 towards a customer's premises. The copper pairs of the loop feeder
25 cable are then individually cross-connected to pairs in smaller cables

1 called loop distribution. The loop distribution cables serve all the
2 houses or businesses in a sub-section of one of the central office's
3 serving areas.

4

5 Q. PLEASE DESCRIBE WHAT YOU REFERRED TO AS LOOP
6 DISTRIBUTION.

7

8 A. Loop distribution facilities have been referred to as the "last mile"
9 because these are the facilities that go the "last mile" to the customer's
10 premises. The loop distribution cables are used to, in effect, "fan out"
11 the cable pairs from the loop feeder cables. In this regard, the cables
12 one would see within a sub-division are generally the loop distribution
13 cables. Between the loop feeder cable and the loop distribution cable
14 is a cabinet, above ground "hut", or below ground "controlled
15 environment vault" within which cross-connections and/or electronics
16 are located.

17

18 Q. WHAT IS INTRA-BUILDING NETWORK CABLE (INC), WHICH IS
19 SOMETIMES REFERRED TO AS "RISER CABLE"?

20

21 A. At a single family home, the loop distribution element connects with
22 what we call a drop wire and the drop wire then connects to the NID
23 I mentioned. In multi-story buildings, INC is that part of BellSouth's
24 loop facilities extending from the building's cable entrance (often in the
25 basement or on the first floor) and rising to each floor. Sometimes INC

1 is connected to NTW, which is in turn connected to the NID. In other
2 cases, NTW is connected directly to the entrance cable. In either
3 case, the NTW terminates at the end-user's NID. INC is used not only
4 to multi-story building situations but also in campus situations where
5 cabling must be run from a central point to each of multiple one-story
6 buildings on the property. Thus, INC is a part of that sub-loop element
7 referred to as loop distribution and is located on the network side of the
8 demarcation point between BellSouth's loop facilities and the inside
9 wire at an end user customer's premises.

10

11 Q. YOU HAVE MENTIONED NETWORK TERMINATING WIRE (NTW).
12 PLEASE TELL US WHAT THAT IS.

13

14 A. In multi-story buildings, NTW is connected to the INC at cross-connect
15 terminals, usually on each floor of the building, and "fans out" the cable
16 pairs to individual customer suites or rooms on the floor. In other
17 structures such as "garden apartments", there is typically no INC (as
18 described previously) and, thus, the NTW connects directly to
19 BellSouth's loop distribution facilities. In this sense, NTW is the "last"
20 component of BellSouth's loop on the network side of the demarcation
21 point. Depending on the Alternative Local Exchange Carrier's
22 (ALEC's) network needs, NTW is a BellSouth sub-loop UNE offering
23 which can be purchased alone or in conjunction with INC when the
24 ALEC purchases unbundled INC. However, ALEC requests for INC as
25 a stand-alone UNE (i.e., without NTW) would be considered by

1 BellSouth via the Bona Fide Request (BFR) process.

2

3 **Q. ARE INTRA-BUILDING NETWORK CABLE (INC) AND NETWORK**
4 **TERMINATING WIRE (NTW) PART OF BELLSOUTH'S LOOP, OR**
5 **ARE THEY "INSIDE WIRE"?**

6

7 **A. INC and NTW are sub-elements of the loop. They are not inside wire**
8 **as that term has traditionally been used. ALECs are entitled to obtain**
9 **sub-loop elements on an unbundled basis, and BellSouth is entitled to**
10 **be compensated for the parts of BellSouth's loop used by an ALEC,**
11 **including INC and NTW. The loop, including all sub-elements, is on**
12 **the network side of the demarcation point or NID.**

13

14 **Q. PLEASE DESCRIBE THE NETWORK INTERFACE DEVICE (NID)**

15

16 **A. Simply stated, the NID provides a demarcation point between**
17 **BellSouth's facilities (that is, the loop) and the customer's facilities (that**
18 **is, the inside wire). Thus, the NID provides a way to connect the loop**
19 **to the inside wire. In some cases, the NID integrates other**
20 **components; for example, a lightning protector or loopback test**
21 **electronics.**

22

23 **Q. WHAT IS BELLSOUTH'S PROPOSAL FOR PROVIDING ACCESS TO**
24 **INTRA-BUILDING NETWORK CABLE (INC) AND/OR NETWORK**
25 **TERMINATING WIRE (NTW)?**

1
2
3
4
5
6
7
8
9
10
11
12
13
14
15
16
17
18
19
20
21
22
23
24
25

A. BellSouth will provide access to INC and/or NTW wire pairs as requested by the ALEC by terminating such pairs on separate connecting blocks serving as an access terminal for the ALEC. BellSouth currently has its own terminal in each garden apartment arrangement or high rise building. BellSouth will create a separate access terminal for any building for which such service is requested. With regard to garden apartments, BellSouth will prewire the necessary pairs to serve each facility on the access terminal BellSouth builds. For garden apartments, this means that each cable pair available to serve customers in that garden apartment building will appear on BellSouth's terminal and on the access terminal. An ALEC wanting to serve a customer in the garden apartment situation would build its terminal at that location and then wire its cable pair to the appropriate prewired location on the access terminal.

The treatment for high rise buildings will be different. BellSouth will still build an access terminal to complement BellSouth's own terminal located in the high rise building. The ALEC wanting to access those facilities will still have to build its own terminal for its cable pairs. However, rather than prewiring the access terminal, BellSouth proposes that it will then receive orders from the ALEC and will wire the access terminal it has created as facilities are needed by the ALECs.

1 BellSouth does not propose to prewire every pair to the access
2 terminal in high rise buildings because it is simply impractical to do so.
3 The garden apartment terminal might have 20 to 25 loops terminated
4 on it, thus making prewiring the access terminal something that can be
5 done with a reasonable effort. On the other hand, high rise buildings
6 may have hundreds or even thousands of pairs, which would make
7 prewiring the access terminal impractical.

8

9 **Q. WHAT IS YOUR UNDERSTANDING OF THE DISPUTE BETWEEN**
10 **AT&T AND BELL SOUTH REGARDING THIS ISSUE?**

11

12 **A. There are four parts to this issue. First AT&T wants this Commission**
13 **to revisit an earlier decision that it made when it determined that**
14 **BellSouth would be allowed to create the "access" terminal located**
15 **between BellSouth's terminal and the ALEC's terminal serving any**
16 **particular garden apartment, and by necessary extension, any high rise**
17 **building. Second, assuming AT&T convinces the Commission to**
18 **revisit this issue in the first instance, AT&T then wants to argue that it**
19 **should have direct access to certain sub-loop elements including NTW**
20 **and INC without the use of the access terminal. That is, AT&T**
21 **evidently thinks that it, and presumably any other ALEC in the state,**
22 **should have the right to go into an equipment closet or some other**
23 **place where BellSouth has network facilities, and be able to tap into**
24 **those facilities directly rather than being required to use the access**
25 **terminal that I described above. The third part of this issue involves a**

1 dispute over what sub-loop elements AT&T gets when AT&T
2 purchases unbundled NTW. The fourth sub-part deals with access to
3 the so-called "first" NTW pair, an issue that BellSouth believes settled
4 but which AT&T nonetheless raises.

5

6 **Q. TURNING TO THE FIRST SUB-ISSUE, HAS THIS COMMISSION**
7 **ALREADY DECIDED THE ISSUE OF WHETHER THERE SHOULD**
8 **BE AN ACCESS TERMINAL IN BOTH THE CASE OF GARDEN**
9 **APARTMENTS AND HIGH RISE BUILDINGS?**

10

11 **A. Yes. This Commission has considered the issue of access to the sub-**
12 **loop element referred to as NTW in the arbitration proceedings**
13 **between BellSouth and MediaOne in Docket No. 990149-TP.**

14

15 This Commission denied MediaOne direct access to NTW and
16 required an access terminal to be placed between BellSouth's network
17 and MediaOne's network. The access terminal gives MediaOne the
18 access to NTW it desires without reducing network reliability and
19 security. BellSouth believes the underlying issues here (that is,
20 providing an ALEC unbundled access to INC while preserving network
21 reliability and security) are the same as were addressed in the
22 MediaOne arbitration cited above. This Commission determined that
23 MediaOne and others could gain access to unbundled NTW without
24 reducing network security and reliability by adopting BellSouth's
25 proposed form of access. A portion of that Order follows:

1
2
3
4
5
6
7
8
9
10
11
12
13
14
15
16
17
18
19
20
21
22
23
24
25

The record does not contain evidence of any case which would support a proposal where one party is seeking to use its own personnel to, in effect, modify the configuration of another party's network without the owning party being present. We find that MediaOne's proposal to physically separate BellSouth's NTW cross-connect facility from BellSouth's outside distribution cross-connect facilities is an unrealistic approach for meeting its objectives. Therefore, BellSouth is perfectly within its rights to not allow MediaOne technicians to modify BellSouth's network.

Based on the evidence presented at the hearing, we believe that it is in the best interests of the parties that the physical interconnection of MediaOne's network be achieved as proposed by BellSouth.

BellSouth believes the use of access terminals as ordered by the Florida Commission gives ALECs the requested access to unbundled sub-loop elements while still maintaining network reliability and security. Such access should apply to all sub-loop elements, including access to INC.

Q. WHAT DID MEDIAONE WANT WITH REGARD TO NETWORK TERMINATING WIRE (NTW) IN THE ARBITRATION REFERENCED?

1 A. As with AT&T in this proceeding, MediaOne wanted direct access to
2 BellSouth's terminals at which BellSouth terminates its NTW for
3 multiple residential dwelling units without the involvement of a
4 BellSouth technician.

5

6 Q. WHAT WAS BELLSOUTH'S PROPOSAL AS PRESENTED IN THE
7 MEDIAONE DOCKETS?

8

9 A. I proposed the following in my direct testimony:

10

11 BellSouth offers a reasonable method of access to the
12 NTW in BellSouth's garden terminal. Using BellSouth's
13 proposed method, the ALEC installs its own terminal in
14 proximity to the BellSouth garden terminal. BellSouth
15 installs an access terminal that contains a cross-connect
16 panel on which BellSouth will extend the ALEC requested
17 NTW pairs from the garden terminal. The ALEC will then
18 extend a tie cable from their terminal and connect to the
19 pairs they have requested. The ALEC would then install
20 its own Network Interface Device (NID) within the end-
21 user apartment and connect the ALEC requested pair(s)
22 to this NID. This manner of access retains network
23 reliability, integrity, and security for both BellSouth's
24 network and the ALEC's network.

25

1 Q. HAS THIS ISSUE BEEN CONSIDERED BY ANY OTHER STATE
2 COMMISSION IN BELLSOUTH'S REGION?

3
4 A. Yes. The Georgia Public Service Commission considered a similar
5 request by MediaOne. In Georgia the Commission also required the
6 use of an access terminal, but concluded that a BellSouth employee
7 did not have to be present when a MediaOne employee moved loops
8 from one terminal to the other. BellSouth obviously believes that the
9 Florida Commission's decision is more appropriate and serves to
10 protect the network more than the decision reached in Georgia

11
12 Q. HOW DOES THIS RELATE TO THE ISSUE OF ACCESS TO FACILITIES IN
13 HIGH RISE BUILDINGS?

14
15 A. Just as there was a very good reason to require an access terminal in
16 the garden apartment situation, there is even a better reason to require
17 such an access terminal in high rise buildings, for the reasons I
18 articulate below. I would note that my remarks here also address the
19 second sub-issue, which involves what the Commission should do if it
20 determines that it will revisit the issue of requiring an access terminal
21 between BellSouth's terminal and the ALECs' terminals for situations
22 where INC and NTW are involved.

23
24 Specifically, even in a simple residential garden apartment situation,
25 bridging the working pairs over to the access terminal could, in fact,

1 disturb working customers' services. In a commercial high-rise
2 building involving business customers with high-speed digital data
3 services operating 24 hours per day, the problem is even more acute.
4 Any disturbance of a working circuit would cause irreparable harm to
5 existing services and subject BellSouth to lawsuits and out-of-service
6 claims. Furthermore, such interruptions could and would be
7 considered by some customers as a serious breach of security.

8
9 Further, and while I am in no way disparaging AT&T's or any other
10 ALEC's technicians, with direct access it is possible for AT&T's or
11 other ALECs' technicians to intentionally or unintentionally disrupt
12 BellSouth's and other ALECs' end user services. That simply presents
13 an unnecessary risk for all involved parties, end users, BellSouth, other
14 ALECs, and AT&T itself (i.e., because such actions by some other
15 ALEC could have the same disrupting effect on existing sub-loop
16 elements that AT&T is utilizing.)

17
18 Further, with direct access, BellSouth would be at AT&T's and other
19 ALECs' mercy to tell BellSouth how, when, where, and the amount of
20 BellSouth's facilities that were being used. I will discuss the record
21 keeping issues involved below, but the bottom line is that such
22 uncontrolled access to these sub-loop elements would have a totally
23 debilitating effect on BellSouth's ability to maintain accurate cable
24 inventory records. It would be simply impossible for BellSouth to ever
25 have an accurate record of its facilities if every ALEC in the state had

1 direct access to these facilities. Of course, the lack of accurate
2 inventory information would result in imminent failure of BellSouth's
3 (and ALECs' using loops and sub-loop elements acquired from
4 BellSouth) service provisioning, maintenance and repair processes. I
5 do want to be perfectly clear about this. What we are talking about
6 here, if AT&T gets its way, is allowing technicians from any and every
7 ALEC in Florida to walk into an equipment room in a high rise building
8 and start appropriating pairs and facilities for its own use, without
9 consulting with anyone and without any obligation to keep appropriate
10 records so that the next person in the room knows what belongs to
11 whom. It doesn't take much imagination to know what a disaster this
12 would end up being for BellSouth and for the customers in the building
13 in question. It should be noted that *any* mechanized cable
14 management system (CMS) available in the telecommunications
15 market today has at its core the fundamental requirement that the
16 manager of the CMS maintain absolute and full control over cable pair
17 assignment. To do otherwise would result in chaotic failure of the
18 service delivery and maintenance system.

19

20 Q. PLEASE DISCUSS THE ISSUE YOU MENTIONED REGARDING
21 KEEPING RECORDS IF THE ALECs ARE ALLOWED TO WORK
22 DIRECTLY ON BELL SOUTH'S TERMINAL IN CIRCUMSTANCES
23 SUCH AS THOSE WE ARE TALKING ABOUT HERE.

24

25 A. Keeping accurate records of what pairs are spare, working, or

1 defective is critical to ensuring high quality service, both in provisioning
2 new or additional customer lines and in repairing existing customers'
3 service. In the case of INC, maintaining accurate inventory records is
4 especially critical. NTW records consist generally as paper tags for
5 each pair of wires that are present at the NTW garden terminal. A
6 technician can usually determine the use to which a particular pair is
7 being put while on-site either via the tag or by electrically testing the
8 NTW. However, such "intrusive testing" by electrically testing the NTW
9 is the cause of disturbance on the line. This is because such intrusive
10 testing cannot be done without interrupting existing line transmissions.
11 Such disturbances can quickly lead to end user dissatisfaction.

12
13 INC cable records are even more problematic because they are
14 mechanized records not available at the access terminal. As
15 mechanically inventoried records, individual assignments of INC pairs
16 are made as orders for service are processed. Should particular INC
17 pairs become unusable, a notation is made in the records system so
18 that the pairs are not assigned as the need arises for additional pairs.
19 Thus, a field technician has no way of using particular INC pairs
20 without risking disruption of service to existing end users. As I
21 discussed earlier, using a test set to determine whether the cable pair
22 is in use would disrupt an in-progress transmission. Utilizing INC pairs
23 at random could result in taking an existing end user out of service, or
24 in having the new end user's service be inoperable because of a faulty
25 INC pair. Should a technician by chance choose a spare INC pair and

1 **successfully install the end user's service, there is no means of**
2 **protecting that service from potential disruptions resulting from the next**
3 **technician entering that work area, no matter whether that technician is**
4 **employed by BellSouth, AT&T, or another ALEC. As subsequent**
5 **technicians enter the work scene, the existing INC cable pair records**
6 **would progressively deteriorate, creating an immediate and significant**
7 **service problem that would be extremely costly and difficult to correct.**

8

9 **The bottom line is that allowing an ALEC's technician to try to locate**
10 **spare facilities to provide service will result in service degradation and**
11 **chaotic service provisioning by all carriers.**

12

13 **Q. ARE THERE OTHER CONCERNS TO REPORTING AND**
14 **INVENTORY WITH RESPECT TO THIS ISSUE?**

15

16 **A. Yes, and these comments go directly to the heart of the issue of**
17 **whether a BellSouth technician will be allowed to place the jumpers for**
18 **the ALEC between the BellSouth terminal and the access terminal**
19 **created for the use of the ALECs. Without the involvement of a**
20 **BellSouth technician, BellSouth will have no way of knowing who is**
21 **using what pair and who should be paying for what pair. It would be**
22 **entirely possible for an ALEC to provide service over a pair without**
23 **BellSouth ever knowing that it should charge the ALEC.**

24

25 **Therefore, as it did with the garden terminals, BellSouth proposes to**

1 construct an access terminal. However, it is simply not feasible to
2 prewire every cable pair in every high rise building to the access
3 terminal. Unlike the situation with the garden terminals, there can be
4 hundreds or even thousands of pairs in a high rise building. What
5 BellSouth proposes therefore, is that it not prewire every cable pair, but
6 rather that it be allowed to take orders from the ALECs to prewire just
7 what each ALEC needs, as the ALEC needs the facilities.

8

9 **Q. HAVE YOU PREPARED AN EXHIBIT WHICH ILLUSTRATES**
10 **BELLSOUTH'S PROPOSAL REGARDING SUB-LOOP UNBUNDLING**
11 **IN A MULTI-STORY BUILDING?**

12

13 **A. Yes. Exhibit WKM-1, which is attached to this testimony, contains**
14 **three (3) pages that I hope will aid in understanding this issue. Page 1**
15 **shows a typical serving arrangement in multi-story buildings for which**
16 **BellSouth is, at present, the sole provider of telephone service. Page 2**
17 **shows BellSouth's proposed form of access for an ALEC to the sub-**
18 **loop elements INC and NTW. BellSouth proposes the use of an**
19 **access terminal that is cross-connected by tie cable with the terminals**
20 **of both BellSouth and the ALEC. The access terminal for unbundled**
21 **INC (UINC) and the access terminal for unbundled network terminating**
22 **wire (UNTW) access could also serve as a single point of**
23 **interconnection for use by multiple carriers. Page 3 shows the typical**
24 **access to UNTW in a "garden" apartment complex. The point to be**
25 **made here is that the access terminal is cross-connected by tie cable**

1 pairs with the terminals of both BellSouth and the ALEC thus allowing
2 an ALEC access while preserving network reliability and security.

3

4 Q. DOES AT&T HAVE ALTERNATIVES TO USING BELLSOUTH'S
5 FACILITIES IN GARDEN STYLE APARTMENT SETTINGS?

6

7 A. Yes. Testifying on behalf of AT&T and MCI WorldCom, witness Ms.
8 Brenda Kahn, addressed alternatives during a hearing before this
9 Commission in Docket No. 990649-TP. A relevant portion of the
10 transcript from that hearing beginning on page 2383 at line 13 where
11 Ms. Kahn testified is as follows:

12

13 *Q. Ms. Kahn, did I understand you to say that you could build*
14 *the garden terminals, that your real area of concern was the*
15 *high-rise building, access to the high-rise building?*

16

17 *A. That's my understanding, that we have several ways we're*
18 *offering cable telephony today. I know my niece in Denver has*
19 *cable telephony through AT&T, and we will do what's called*
20 *direct connect where we use our own facilities end to end.*

21

22 *In these garden terminal situations, it's easier to put your*
23 *own terminal on property because you have less concern about*
24 *space limitation.*

25

26 Q. WHAT DOES AT&T PREFER IN SITUATIONS WHERE THERE ARE
27 MULTIPLE GARDEN TERMINALS?

28

29 A. AT&T apparently prefers to do it themselves as evidenced by Ms.
30 Kahn's response to this question at the aforementioned hearing
31 beginning at line 8 of page 2384 of the transcript:

1
2
3
4
5
6
7
8
9
10
11
12
13
14
15
16
17
18
19
20
21
22
23
24
25
26
27
28
29
30
31
32
33
34

Q. Is it your testimony then that you don't need direct access to the garden terminal situation in an apartment arena because you can construct your own garden terminal?

A. Well, I don't want to mislead you. I mean, there may be situations where we will want to use the BellSouth garden terminal; however, even in that situation, as I understand it, since there could be multiple garden terminals on the same property, we would prefer to actually meet the BellSouth – have the single point of interconnection at just one site rather than meeting them at, let's say, three garden terminals. So that's why I say it's more likely we build our own in a situation where there are multiple garden terminals.

Q. WOULD A COST ESTABLISHED BY THIS COMMISSION IMPEDE AT&T'S ABILITY TO COMPETE IN APARTMENT COMPLEXES?

A. Apparently not according to Ms. Kahn's comment beginning at line 17 on page 2385 of the transcript:

COMMISSIONER JABER: So if the cost is prohibitive for the apartment scenario, you have an alternative.

MS. KAHN: Yes.

Q. WHAT MEANS OF ACHIEVING A PROPERLY MAINTAINED ACCESS TERMINAL SHOULD BE ADOPTED BY THIS COMMISSION?

BellSouth believes the appropriate method is to require BellSouth to construct an access terminal for INC pairs as may be requested by an ALEC, specifically the number of pairs needed and the floors to which

1 the pairs are needed. AT&T (or another ALEC) would interconnect its
2 network to these constructed access terminals. Such a methodology
3 would permit ALECs appropriate access to end users while providing
4 both companies the ability to maintain appropriate records on an on-
5 going basis.

6

7 **Issue 13: What are the appropriate means for BellSouth to provide**
8 **unbundled local loops for provision of DSL service when such loops are**
9 **provisioned on digital loop carrier facilities?**

10

11 Q. WHAT IS YOUR UNDERSTANDING OF THE DISAGREEMENT
12 BETWEEN AT&T AND BELL SOUTH CONCERNING ISSUE 13?

13

14 A. BellSouth and AT&T disagree as to BellSouth's obligations in cases
15 where a given end user's loop is provided over equipment referred to
16 as Digital Loop Carrier and that end user wants Digital Subscriber Line
17 (xDSL) service which is incompatible with the DLC serving that end
18 user. AT&T has proposed that in such cases, BellSouth must provide
19 AT&T with three different solutions in that situation; BellSouth agrees
20 that two of the three solutions are acceptable, but the third method is
21 not.

22

23 Q. WHAT ARE THE TWO SOLUTIONS BELL SOUTH AGREES TO
24 PROVIDE TO AT&T?

25

1 **A.** The first solution is to move the end user to a loop that is suitable for
2 xDSL service. For example, if the end user is served via DLC but a
3 spare copper loop is available to the end user's premises, BellSouth
4 agrees to move the end user to the copper loop that is capable of
5 supporting xDSL services. BellSouth provides access to all its loops
6 on an unbundled basis including those loops served by DLC
7 equipment. BellSouth has developed a number of different methods
8 for providing such unbundled access, thus ensuring that each and
9 every BellSouth loop can be provided on an unbundled basis
10 regardless of whether the end user (when that end user was a
11 BellSouth customer) is served via DLC.

12
13 The second solution is to allow AT&T to collocate its Digital Subscriber
14 Line Access Multiplexer (DSLAM) in the remote terminal housing the
15 DLC and give AT&T access to the unbundled network element referred
16 to as loop distribution. BellSouth agrees that in any case where it has
17 installed its own DSLAM in a given remote terminal, BellSouth will
18 accommodate collocation requests from AT&T or any other ALEC even
19 if that means that room inside the remote terminal must be augmented
20 or that the remote terminal itself must be expanded or replaced to
21 make room for AT&T's or another ALEC's DSLAM.

22
23 **Q.** **ABOUT WHICH AT&T PROPOSED SOLUTION DO AT&T AND**
24 **BELLSOUTH DISAGREE?**

25

1 A. AT&T has proposed as a third solution to this issue that BellSouth
2 would provide an unbundled loop and, in addition, would provide a
3 functionality referred to as Asynchronous Transfer Mode (ATM)
4 switching, a form of packet switching. BellSouth opposes the use of
5 this third method for two reasons. First, this solution is not needed. If
6 the loop serving the end user is not capable of DSL service, BellSouth
7 has agreed to provide another loop that is suitable to the extent that
8 such loop exists. If a suitable loop is simply not available, or if AT&T
9 prefers to, AT&T can collocate its DSLAM within BellSouth's remote
10 terminal as I described earlier. AT&T can then use its own DSLAM
11 plus unbundled loop distribution acquired from BellSouth to provide its
12 DSL service. AT&T has two viable options for providing DSL service
13 when the end user is served via DLC. Second, the FCC's recent
14 Advanced Services Order specifically exempts BellSouth from a
15 requirement to unbundle packet switching if it meets certain
16 requirements. That requirement is to accommodate an ALEC's
17 request for collocation of the ALEC's DSLAM in remote terminals
18 where BellSouth has installed its own DSLAM. As I noted above,
19 BellSouth has agreed to such collocation. Thus, there is no
20 requirement that BellSouth provide packet switching such as ATM on
21 an unbundled basis.

22
23 Q. WHAT OTHER SOLUTION DOES BELLSOUTH OFFER?

24
25 A. BellSouth will provide to AT&T unbundled access to the high frequency

1 portion of the loop at the remote terminal as well as at the central
2 office. This arrangement is referred to as line sharing. BellSouth
3 proposes that AT&T could collocate its DSLAM equipment at the
4 remote terminal and BellSouth would provide a "splitter" at that same
5 remote terminal.

6

7 **Q. WHAT IS A SPLITTER?**

8

9 **A. Splitters are used to separate the low frequency signals (that is, the**
10 **voice service that BellSouth would continue to provide to the customer)**
11 **from the high frequency signal (that is, the xDSL data traffic). The low**
12 **frequency portion of the local loop spectrum is routed to the voice**
13 **switch via the DLC equipment. The splitter routes the high frequency**
14 **portion of the circuit to the ALEC's xDSL equipment located in its**
15 **collocation space at the serving wire center or the remote terminal.**

16

17 **Q. WHAT SOLUTION TO THIS ISSUE DOES BELLSOUTH PROPOSE?**

18

19 **A. This Commission should affirm that BellSouth has met its obligations**
20 **for providing access to unbundled loops and for collocation in its**
21 **remote terminals and as a result is not obligated to provide AT&T with**
22 **unbundled packet switching.**

23

24

25

1 **Issue 14: What coordinated cutover process should be implemented to**
2 **ensure accurate, reliable, and timely cutovers when a customer changes**
3 **local service from BellSouth to AT&T?**

4

5 Q. WHAT IS BELLSOUTH'S POSITION ON THIS ISSUE?

6

7 A. The coordinated cutover process proposed by BellSouth ensures
8 accurate, reliable, and timely cutovers. No changes in this process are
9 necessary or appropriate at this time.

10

11 BellSouth and AT&T agree on many aspects of how hot cuts should be
12 performed. For example, BellSouth agrees with AT&T that the hot cut
13 process should be well documented and that procedures should be put
14 in place that will ensure that the process is adhered to during a
15 cutover. As a result of recent hearings before the North Carolina
16 Utilities Commission addressing this issue and despite agreement
17 between BellSouth and AT&T regarding most of the steps involved in
18 the hot cut process, there remain four areas of disagreement for which
19 the parties need this Commission's help in resolving.

20

21 Q. WHAT ARE THE FOUR AREAS OF DISAGREEMENT BETWEEN
22 BELLSOUTH AND AT&T REGARDING HOW HOT CUTS SHOULD
23 BE PERFORMED?

24

25 A. The first area of disagreement deals with whether BellSouth should

1 check to determine that appropriate loop facilities are available before
2 BellSouth returns a Firm Order Confirmation or "FOC" to AT&T in
3 response to AT&T's sending its order to BellSouth. With the FOC,
4 BellSouth provides to AT&T the date that, barring unforeseen
5 circumstances such as facility shortages, severe weather, acts of God,
6 manpower shortages, and the like, BellSouth will convert service from
7 BellSouth to AT&T. No facilities check is done, and AT&T wants this
8 changed so that BellSouth performs a facilities check before returning
9 the FOC to AT&T.

10

11 In response, I would make two points. BellSouth does not perform
12 facilities check for its own retail customers prior to establishing a due
13 date for the order. Therefore, under the present process, AT&T
14 receives the same treatment that BellSouth's own retail units receive
15 when an order is placed. Second, to advance the facilities check from
16 the provisioning portion of processing an order to the "ordering" stage,
17 which is what AT&T proposes, would delay the transmission of the
18 FOC which AT&T needs in order to confirm due dates with its end user
19 and to schedule its own resources needed for the cutover. I believe
20 the existing process strikes a balance between the need for timely
21 FOC production against the few instances where facilities are not
22 immediately available. These infrequent facilities shortages impact
23 BellSouth's customers and AT&T's customers equally.

24

25 The second area of disagreement is what BellSouth should do in

1 response to an error in the database that keeps records of Connecting
2 Facilities Assignments or "CFAs". As the name implies, connecting
3 facilities are the cables between BellSouth's distributing frame and
4 AT&T's collocation arrangement in a central office. The dispute here is
5 simple. When AT&T sends an order to BellSouth, AT&T dictates which
6 of the connecting facilities BellSouth is to use to connect a particular
7 customer's loop to AT&T's collocation arrangement. When an order is
8 placed and BellSouth finds that AT&T has made an error, such that the
9 designated connecting facility is not available to be used to work the
10 order AT&T has assigned it to, BellSouth asks AT&T for a clarification.
11 BellSouth asks for a clarification from AT&T because the order cannot
12 be worked until the conflict is resolved and only AT&T knows what
13 action it wants to take (for example, to use a different cable pair or
14 disconnect the first pair) in order to resolve the discrepancy.

15

16 On the other hand, instead of its order being returned for clarification
17 when BellSouth finds that AT&T has made an error, AT&T wants
18 BellSouth to notify AT&T that the order is in a jeopardy condition. The
19 difference is significant. If a clarification is requested, AT&T must
20 resubmit the order. If BellSouth issues a "jeopardy" notice, which
21 generally means something has gone wrong and it is BellSouth's
22 responsibility, the order holds its place in queue while BellSouth
23 attempts to resolve the issue. Obviously AT&T would rather have the
24 order hold its place, rather than resubmitting the order.

25

1 However, BellSouth's mechanized systems do not allow for such
2 jeopardy notification of errors in AT&T's order. Further, even if
3 BellSouth's operations systems could treat AT&T's errors as jeopardy
4 conditions rather than clarifications, the net effect would be delays in
5 fulfilling the requests of other local service providers since BellSouth
6 would have to keep resources committed to AT&T's order until AT&T
7 resolved the jeopardy condition. I would note that a situation involving
8 CFA database discrepancies is the only situation of which I am aware
9 that could cause a clarification to be sent to AT&T after the FOC has
10 been sent to AT&T.

11
12 The third area of disagreement deals with when, before the cutover,
13 BellSouth is to call AT&T so that the final decision of whether to
14 proceed with the cutover can be made. BellSouth commits to
15 contacting AT&T 24 to 48 hours in advance of the cut to verify the
16 cutover time and to verify AT&T's readiness to convert the customer's
17 service as ordered. AT&T wants that call to always be made at 48
18 hours before the cutover. BellSouth position is that the call should be
19 made in the window of 24 to 48 hours before the cutover because
20 BellSouth does not always know with certainty 48 hours prior to the
21 cutover whether all required steps leading up to the actual cutover can
22 be completed in time. In other words, AT&T's proposal would require
23 the parties to decide 48 hours in advance whether to go forward with
24 the cutover. BellSouth's proposal would give the parties more time
25 and latitude to continue working on any remaining work steps so the

1 cutover can go forward as originally scheduled. BellSouth is willing to
2 agree with AT&T to make the 48 hour call, and to make a go/no go
3 decision, provided that BellSouth is not charged with any due date
4 misses as a result of making such a call. Our point is, of course, that if
5 the cut is ready to go, then we will make the 48 hour call anyway. If it
6 is not ready to go, it is still possible that BellSouth could resolve
7 whatever jeopardy that existed within the 24 hours after the 48 hour
8 call and before the 24 hour call. Since AT&T would take this period
9 away from BellSouth, it is not fair to charge BellSouth with due date
10 misses that could have been avoided, but for AT&T's insistence on a
11 call.

12
13 The fourth area of disagreement deals with the manner in which
14 BellSouth notifies AT&T that the cutover is complete. Based on the
15 testimony of AT&T's witness Mills in North Carolina, it appears that the
16 parties may have resolved this part of the dispute. My understanding
17 of Mr. Mills' testimony is that AT&T is willing to provide an 800 number
18 for BellSouth's use in closing out AT&T's hot cut orders and that the
19 800 number will be staffed such that BellSouth's calls will not be routed
20 to a voicemail system. At times, when attempting to close out an order
21 to AT&T, BellSouth has had difficulty reaching technicians in AT&T's
22 work centers. When this occurred, BellSouth's calls were routed to a
23 voicemail system where the BellSouth technician left a message.
24 BellSouth agrees this part of this issue can be resolved once AT&T
25 provides such an 800 number to BellSouth. BellSouth is willing to call

1 the 800 number to close out AT&T's hot cut orders.

2

3 Q. EVEN THOUGH THE FOUR REMAINING ISSUES SEEM
4 STRAIGHTFORWARD, CAN YOU PROVIDE THE COMMISSION
5 WITH SOME IDEA OF WHAT IS INVOLVED IN PERFORMING A
6 LOOP CUTOVER.

7

8 A. Yes. I have provided Exhibit WKM-2 that shows, pictorially and with a
9 brief narrative, the various work steps involved in a typical loop
10 cutover. These photographs were taken in BellSouth's Norcross,
11 Georgia, central office; however, the work steps are identical in all nine
12 states in BellSouth's region. Briefly, the work steps involved are as
13 follows:

- 14 • The BellSouth central office technician receives a call to begin
15 cutover and asks for the cable pair number of the loop to be
16 cutover. This is shown on page 1 of Exhibit WKM-2.
- 17 • The technician types the cable pair number into a database to find
18 the loop cutover work order number. This is shown on page 2 of
19 Exhibit WKM-2.
- 20 • The technician retrieves a copy of the work order for the unbundled
21 loop. This is shown on page 3 of Exhibit WKM-2.
- 22 • The technician in the BellSouth central office responds to the
23 BellSouth UNE Center's request to initiate coordination of the
24 overall cutover of service from BellSouth to the ALEC. This is
25 shown on page 4 of Exhibit WKM-2.

- 1 • The technician then verifies that the correct loop has been identified
2 for cutover. This is done using a capability referred to as Automatic
3 Number Announcement Circuit ("ANAC"). The technician attaches
4 a test set onto the loop and dials a special code. The telephone
5 number associated with that loop is played audibly. This is shown
6 on page 5 of Exhibit WKM-2.
- 7 • Next, the technician locates the existing jumper on the BellSouth
8 Main Distributing Frame ("MDF") running between the loop and the
9 BellSouth switch port. This is shown on pages 6-7 of Exhibit WKM-
10 2.
- 11 • The technician locates and removes the end of the jumper
12 connected to the BellSouth cable pair. This is shown on page 8 of
13 Exhibit WKM-2.
- 14 • The technician then locates and removes the end of the jumper
15 connected to the BellSouth switching equipment. This is shown on
16 page 9 of Exhibit WKM-2.
- 17 • The technician then connects the one end of a new jumper
18 between the loop and a connector block on a cable rack with tie
19 cables to the ALEC's collocation arrangement. This is shown on
20 page 10 of Exhibit WKM-2.
- 21 • The technician then weaves the new jumper wire through the cable
22 rack to reach the tie cables to the ALEC's collocation arrangement.
23 This is shown on page 11 of Exhibit WKM-2.
- 24 • The technician connects the second end of the new jumper to the
25 connector block and thus the tie cable to the ALEC's collocation

- 1 equipment. This is shown on page 12 of Exhibit WKM-2.
- 2 • The technician next verifies that the loop is connected to the
- 3 expected switch port and telephone number in the ALEC's switch,
- 4 again using ANAC capabilities. This is shown on page 13 of Exhibit
- 5 WKM-2
- 6 • Upon successful completion of the loop cutover, the technician
- 7 verifies with the ALEC that the order was correctly worked, closes
- 8 the work order, and notifies the UNE Center. This is shown on
- 9 page 14 of Exhibit WKM-2.

10

11 Naturally, any errors (both BellSouth's errors and the ALEC's errors)

12 slow the process while corrections are identified and made. While

13 BellSouth should clearly be responsible for its own errors, it should not

14 be held responsible for delayed cutovers due to problems or errors

15 caused by the ALEC. It is obvious from the many steps that have to be

16 taken to correctly perform a loop cutover that the timeframe

17 appropriate for a single loop would not be a reasonable timeframe for a

18 multiple loop cutover for a large end-user such as a major bank or

19 manufacturing firm as most of the individual work steps must be

20 repeated for each loop to be converted.

21

22 Q. IS BELLSOUTH IN TOTAL CONTROL OF THE LOOP CUTOVER

23 PROCESS?

24

25 A. No. As discussed above, loop cutovers require high levels of

1 coordination between BellSouth and the ALEC to which the unbundled
2 loop is being provided. If an ALEC fails to perform a function in a
3 timely fashion, the delay directly impacts the overall cutover time.
4 Therefore, any measurement of average loop cutover times will reflect
5 not only the efficiency of BellSouth's systems and employees' skills,
6 but also the efficiency of the ALEC's systems and employees' skills.
7 For example, one step in the process occurs after the loop is removed
8 from BellSouth's switch and is connected to the ALEC's switch. At this
9 point in the cutover, tests are performed to verify that the loop is
10 connected to the expected switch port and telephone number in the
11 ALEC's switch. However, if the ALEC has a defective switch port, or
12 has provided an invalid switch port number, or any of a number of
13 other possible errors occurs, BellSouth is powerless to move forward
14 until the ALEC takes appropriate corrective steps. While the ALEC is
15 doing so, the total cutover time clock is still running. Thus, while
16 BellSouth strives to complete loop cutovers in as timely and effective a
17 manner as possible, BellSouth cannot be saddled with the entire
18 responsibility for meeting the stated interval, especially given the
19 ALEC's contribution to total cutover time.

20

21 Q. CAN YOU DESCRIBE GENERALLY WHY AT&T'S ORIGINAL
22 PROPOSAL IS NOT ACCEPTABLE TO BELLSOUTH?

23

24 A. Yes. AT&T's proposed contract language, contained in Attachment 2,
25 Exhibit C of the proposed interconnection agreement, is not acceptable

1 to BellSouth. For completeness, I am first going to list the four issues
2 that I have just described and identified as still needing Commission
3 resolution. Then I will discuss the other points in AT&T's proposal that
4 were unacceptable, but that we believe we can resolve without the
5 Commission's assistance.

6

7 1. The first area of disagreement deals with AT&T's proposal that
8 BellSouth provide a facility check prior to providing a Firm Order
9 Confirmation (FOC). This would necessitate a change in
10 BellSouth's legacy operations support systems and require the
11 Loop Facility Assignment Control System (LFACS) to check facility
12 records prior to the order process. Changing the process to check
13 facilities availability prior to returning the FOC to the ALEC would
14 have the effect of slowing BellSouth's delivery of the FOC. Further,
15 except for certain access services and project managed service
16 activations, BellSouth does not check facilities availability prior to
17 committing to a due date for delivery of service to BellSouth's retail
18 customers.

19

20 2. The second area of disagreement deals with whether certain of
21 AT&T's orders should be clarified or instead placed in jeopardy
22 status. AT&T has proposed intervals for FOCs and clarification and
23 rejection notifications which are not consistent with BellSouth's
24 committed intervals. BellSouth believes its intervals for delivery of
25 FOCs and reject notifications are appropriate.

1
2
3
4
5
6
7
8
9
10
11
12
13
14
15
16
17
18
19
20
21
22
23
24
25

Further, AT&T's language states in Paragraph 2.2.3 that "In no event shall BellSouth provide AT&T either a request for clarification or a reject message after BellSouth provides AT&T with a FOC". BellSouth agrees that in most cases there should not be a clarification or reject notification after it sends the FOC to the ALEC. However, there are certain situations where a clarification or reject notification is appropriate. One such example is the situation where AT&T gives BellSouth inaccurate CFA information via AT&T's Local Service Request (LSR) to BellSouth. BellSouth has no way of verifying AT&T's CFA information at the time of receiving AT&T's LSR. At the time such errors are discovered, which is often when BellSouth's mechanized assignment systems recognize that the CFA information provided is in error (a process always performed after the FOC is delivered to the ALEC), such clarification or reject notifications are appropriate. In this case, the cause of the clarification or reject notification is the result of AT&T's error rather than BellSouth's error. If BellSouth were to simply place AT&T's order in jeopardy status, the net effect would be to delay the completion of other ALECs' orders since BellSouth would have to keep resources scheduled and committed during the time it takes for AT&T to correct its problem.

3. The third area of disagreement concerns when BellSouth should call AT&T to confirm the hot cut schedule. AT&T has proposed that

1 prior to a final decision of whether or not to proceed with a cutover,
2 BellSouth contact AT&T 48 hours before the cutover. BellSouth
3 commits to contacting AT&T 24 to 48 hours in advance of the cut to
4 verify the cutover time and to verify AT&T's readiness to convert
5 the customer's service as ordered. BellSouth's position is that the
6 call should be made in the window of 24 to 48 hours before the
7 cutover because BellSouth does not always know with certainty 48
8 hours prior to the cutover whether all required steps leading up to
9 the actual cutover can be completed in time. In other words,
10 AT&T's proposal would require the parties to decide 48 hours in
11 advance whether to go forward with the cutover. BellSouth's
12 proposal would give the parties more time and latitude to continue
13 working on any remaining work steps so the cutover can go forward
14 as originally scheduled.

15
16 4. The fourth area of disagreement deals with procedures for closing
17 out orders with AT&T after the hot cut is completed. AT&T
18 (beginning with Paragraph 3.5.10) requires BellSouth to make
19 multiple attempts to contact a live AT&T technician (rather than
20 leaving a voicemail message) to advise AT&T of completion of the
21 wiring work. BellSouth asserts that if AT&T does not want
22 BellSouth to communicate via a voicemail message when
23 BellSouth's call to AT&T is not answered, then AT&T should
24 appropriately staff its work center to handle the completion calls
25 and acceptance calls from BellSouth's technicians. Again, we think

1 this one is resolved.

2

3 **Q. WHAT OTHER AREAS OF CONTRACT LANGUAGE ARE STILL**
4 **BEING DISCUSSED BETWEEN BELL SOUTH AND AT&T?**

5

6 **A. The following areas are still being jointly discussed between BellSouth**
7 **and AT&T with anticipation that they can be resolved without requiring**
8 **the Commission's involvement:**

9

10 **1. AT&T's language dealing with coordinated and non-coordinated**
11 **order conversions is both confusing and conflicting. For example,**
12 **AT&T discusses order coordination time specific for non-**
13 **coordinated orders. The simple fact is that there is no order**
14 **coordination time specific when AT&T (or any ALEC) orders a loop**
15 **without order coordination (Paragraph 2.1). At a joint**
16 **BellSouth/AT&T negotiation meeting held on May 16, 2000, AT&T**
17 **agreed that AT&T's language was confusing and not what AT&T**
18 **meant. As a result, I understand that AT&T is in the process of**
19 **revising the language.**

20

21 **2. AT&T's language assumes that the interval for all loops is the**
22 **same, which is not the case. With AT&T's proposal then, the timing**
23 **of a pre-conversion function would be predicated on every request**
24 **having the same overall installation interval. BellSouth's pre-**
25 **conversion and conversion testing and coordination activities are**

1 predicated on when the conversion is scheduled to take place.
2 This is to meant to ensure that both parties have completed wiring,
3 translations, and continuity checks and are ready to perform the
4 conversion at a time that has a high probability of success.
5 (Paragraphs 3.4 and 3.5).

6

7 3. AT&T proposes intervals for conversions that are not realistic
8 (Paragraph 3.5.4.). BellSouth does agree that both parties should
9 complete conversions of ten (10) loops or less in 60 minutes using
10 best efforts. However, AT&T proposes that loop cutovers of more
11 than 11 loops should be cut in less than 120 minutes. This is not
12 realistic. For example, the loop cutover might be for a customer
13 with 400 loops. Under AT&T's proposal, such a cutover could take
14 no more that 120 minutes. BellSouth proposes that the parties
15 would use best efforts to convert loop cutovers ten (10) loops or
16 less as quickly as possible but in less than 60 minutes. For
17 cutovers of between 11 and than 30 loops, BellSouth proposes the
18 conversion be completed as quickly as possible but in less than in
19 120 minutes.

20

21 4. AT&T's language in Paragraph 3.5.5 again deals with a non-
22 coordinated order that has time specific conversion language.
23 Also, AT&T's proposal calls for AT&T to port a number with no
24 confirmation that BellSouth has completed its wiring. In contrast,
25 BellSouth's process calls for a notification call to AT&T be made so

1 that AT&T can then send the activate message to the Number
2 Portability Administration Center (NPAC) reducing the possibility of
3 an end user experiencing outage unnecessarily.

4
5 5. Paragraph 3.5.11 is in conflict with Paragraph 3.5.5 again dealing
6 with BellSouth calling AT&T at completion of the wiring work to
7 notify AT&T to send its activate message to NPAC. AT&T's
8 proposal again makes confusing references to non-coordinated
9 orders and activities that only are associated with coordinated
10 orders (for example, references to time specific cutovers).

11
12 6. In Paragraph 3.5.11.2, AT&T's proposal makes confusing
13 references to non-coordinated orders and activities that only are
14 associated with coordinated orders (for example, the references to
15 time specific cutovers for non-coordinated orders).

16
17 7. AT&T provides an entire appendix dealing with new loop turn up
18 that uses the same language proposed for dealing with hot cut
19 conversions. This is not appropriate since there is no conversion of
20 live service (that is, the service is not "hot" at the time the loops are
21 turned up), but rather only the turn up of new service to the end
22 user. My understanding is that AT&T admitted in a meeting with
23 BellSouth on May 16, 2000, that the language proposed was not
24 what they intended and that they would rewrite their proposal.

25

1 Q. WHAT EFFECT OR IMPACT DOES BELLSOUTH'S HOT CUT
2 PROCESS HAVE ON CUSTOMERS WANTING TO CHANGE THEIR
3 LOCAL SERVICE TO AT&T?

4
5 A. A customer may experience service outage if either service provider
6 fails to follow a rational and consistent process for converting live
7 service. However, this is not the norm nor has BellSouth exhibited a
8 pattern of failure that has resulted in the level of service outage alleged
9 to have been experienced by AT&T end users.

10
11 BellSouth uses a very detailed process for conversion of live local
12 service and uses these same procedures across the region for all
13 ALECs with a high level of success.

14
15 Q. WHAT HAS BELLSOUTH PROVIDED TO AT&T REGARDING
16 BELLSOUTH'S HOT CUT PROCEDURES?

17
18 A. BellSouth and AT&T have created a detailed flow chart depicting the
19 entire process. This process flow is attached to this testimony as
20 Exhibit WKM-3. This information was shared with AT&T on May 14,
21 1999, and AT&T concurred on June 9, 1999, that this was an accurate
22 depiction of the process. BellSouth has met with AT&T on many
23 occasions to discuss and answer questions regarding the procedures
24 utilized. When AT&T converted to Electronic Data Interchange (EDI)
25 for its coordinated hot cut orders, the flow chart was revised to reflect

1 the electronic order flow. This revised process flow is depicted on
2 Exhibit WKM-4 which is attached to this testimony and was provided to
3 AT&T on April 26, 2000. BellSouth has recently modified its flow
4 charts to more accurately depict the appropriate BellSouth work group
5 performing a given function. These changes were minor modifications
6 and do not change the scope of BellSouth's pre-conversion,
7 conversion or post-conversion responsibilities. These changes reflect
8 only processes internal to BellSouth so the changes do not alter the
9 interactions between BellSouth and AT&T. This last process flow is
10 depicted in Exhibit WKM-5 which is attached to this testimony and has
11 been discussed with AT&T. I agree that continual process
12 improvement is good business practice. Process improvements have
13 been and likely will continue to be discovered and put into day-to-day
14 practice. However, what I do not agree with is that BellSouth's
15 practices are inadequate or that AT&T's proposed processes are an
16 improvement on BellSouth's processes for the reasons I pointed out
17 earlier.

18

19 Q. HAS BELLSOUTH PROPOSED CONTRACT LANGUAGE
20 INCORPORATING THIS PROCESS FLOW?

21

22 A. Yes. BellSouth has proposed language in the current ongoing contract
23 negotiations with AT&T which supports these detailed process flows
24 and provides additional support of BellSouth's commitment to provide
25 coordinated conversions to AT&T which afford a meaningful

1 opportunity to compete for local service.

2

3 BellSouth's processes provide for a conversion, which should ensure a
4 smooth transition for an end user electing to change local service
5 providers from BellSouth to AT&T with minimal end user service
6 interruption.

7

8 Q. HAS BELLSOUTH DEVELOPED METHODS AND PROCEDURES
9 (M&Ps) FOR ITS PROCESS FLOW?

10

11 A. Yes. BellSouth's M&Ps are attached to this testimony as Exhibit
12 WKM-6 and address the following:

- 13 • BellSouth's processes when AT&T orders a coordinated conversion
14 and whether they want to set the conversion time for an offered day
15 or whether they elect to have the time mutually agreed to prior to
16 conversion.
- 17 • BellSouth's requirements to contact AT&T at any point in the
18 provisioning process where a jeopardy condition might result in a
19 conversion delay.
- 20 • BellSouth's commitment to contact AT&T 24 to 48 hours in advance
21 of the cut depending on the interval for the service ordered, to
22 negotiate a non-time-specific conversion and/or to verify AT&T's
23 readiness to convert the customer's service as ordered.
- 24 • BellSouth's testing responsibilities prior to conversion as well as on
25 the conversion date to ensure the conversion is completed

1
2
3
4
5
6
7
8
9
10
11
12
13
14
15
16
17
18
19
20
21
22
23
24
25

successfully.

- BellSouth's willingness to notify and cooperatively work with AT&T to correct any wiring defects which BellSouth identifies while performing pre-testing activities whether the fault appears to be in BellSouth's or AT&T's equipment.
- AT&T's ability to accept or reject the completion of a conversion prior to BellSouth completing the service request and BellSouth's obligation to timely notification to AT&T for the porting of telephone numbers.

Q. HOW DOES BELLSOUTH'S CONFIRMATION PROVIDE AT&T WITH A COMMITMENT FROM BELLSOUTH THAT THE HOT CUT WILL BE PERFORMED AT THE REQUESTED TIME?

A. BellSouth provides two options to AT&T that I believe allow AT&T the flexibility to meet AT&T's business needs. With the first option, AT&T can set a time for a loop conversion by ordering and paying for time specific order coordination. With this option, BellSouth commits to use best efforts to complete the conversion as specified by AT&T at the ordered time and by the offered date. If unforeseen circumstances occur during the provisioning process which may cause the date or time of the conversion to be in jeopardy, BellSouth notifies AT&T as soon as the jeopardy is identified to allow AT&T to respond to its customer as appropriate.

1 **However, if AT&T elects not to order via the first option (that is, time**
2 **specific order coordination) AT&T may request order coordination from**
3 **BellSouth. This second option provides for BellSouth and AT&T to**
4 **mutually agree on the conversion time 24 to 48 hours in advance of the**
5 **conversion. Again, if unforeseen circumstances occur that may**
6 **jeopardize BellSouth's ability to perform the conversion, BellSouth**
7 **notifies AT&T as soon as the jeopardy is identified.**

8

9 **Q. PLEASE EXPLAIN THE PROCESS ASSOCIATED WITH**
10 **MAINTAINING THE CONNECTING FACILITY ASSIGNMENT (CFA)**
11 **DATABASE.**

12

13 **A BellSouth provides AT&T with the connecting facility assignments (that**
14 **is, cable and pair assignments for the cable between AT&T's**
15 **collocation arrangement and BellSouth's equipment such as**
16 **distributing frames or cross-connect bays) assigned to AT&T at the**
17 **time AT&T's collocation arrangement is made available. AT&T is**
18 **required to maintain its own connecting facility assignment records,**
19 **just as all other ALECs are required to do, and assign each pair that**
20 **AT&T wants BellSouth to use in order to connect BellSouth's facilities**
21 **to AT&T's facilities. In a case where BellSouth's processing of an**
22 **AT&T order identifies an error (for example, AT&T's order shows an**
23 **assignment for a CFA cable pair that is already working), BellSouth**
24 **sends a clarification request back to AT&T. This is because the order**
25 **cannot be worked until the conflict is resolved and only AT&T knows**

1 what action it wants to take (for example, to use a different cable pair
2 or disconnect the first pair) in order to resolve the discrepancy.

3

4 **Q. HAS BELLSOUTH INVESTIGATED THE CLAIMS BY AT&T THAT**
5 **THE CONNECTING FACILITY ASSIGNMENT DATABASE IS NOT**
6 **CURRENT?**

7

8 **A. Yes. BellSouth has performed audits for AT&T at no charge to**
9 **reconcile AT&T records. The findings were that the BellSouth**
10 **database was correct for 95% of the more than 3,400 AT&T**
11 **assignments and that AT&T's records were incorrect for 74% of the**
12 **assignments. I have attached as Exhibit WKM-7, BellSouth's response**
13 **to AT&T dated February 28, 2000, regarding this audit. Please note**
14 **that AT&T itself shares a responsibility in keeping the database by**
15 **accurately informing BellSouth of the facility assignments it expects**
16 **BellSouth to use. AT&T, at its discretion, could verify by physical**
17 **inspection at its collocation arrangement, the facility assignments it is**
18 **assigning to BellSouth and thus minimize or eliminate this source of**
19 **database inaccuracy.**

20

21 **AT&T also incorrectly asserts that customer service is in jeopardy**
22 **when porting numbers where "create" and "concurrency" messages**
23 **are exchanged prior to the cutover from BellSouth to AT&T. In fact,**
24 **the number is actually not ported until BellSouth and AT&T have**
25 **completed the conversion and AT&T has had an opportunity to accept**

1 the service. At this point, AT&T sends the "activate" message to the
2 NPAC which results in the porting of the number. The coordinated
3 conversion process is aimed at ensuring that both parties perform
4 required pre-service testing and wiring and that the transfer of the
5 physical work is completed before the number ports from one service
6 provider to another. BellSouth's procedures provide for this and are
7 consistent with standard industry processes utilized to coordinate and
8 port numbers associated with loop conversions.

9

10 Q. WHAT SOLUTION TO THIS ISSUE DOES BELLSOUTH PROPOSE?

11

12 A. This Commission should affirm that BellSouth uses a very detailed
13 process for conversion of live local service and that no changes in the
14 process are necessary. These same procedures are used with a high
15 level of success across the region for all ALECs. BellSouth has
16 proposed language that supports these detailed process flows and
17 provides additional support of BellSouth's commitment to provide
18 coordinated conversions to AT&T which afford a meaningful
19 opportunity for AT&T to compete for local service. BellSouth's
20 processes provide for a conversion that should ensure a smooth
21 transition for an end user electing to change local service providers
22 from BellSouth to AT&T with minimal end user service interruption.

23

24 **Issue 18: What are the appropriate intervals for the delivery of**
25 **collocation space to AT&T?**

1
2
3
4
5
6
7
8
9
10
11
12
13
14
15
16
17
18
19
20
21
22
23
24
25

Q. WHAT IS BELLSOUTH'S POSITION ON THIS ISSUE?

A. BellSouth accepts the intervals that this Commission has established in arbitration proceedings to date. BellSouth acknowledges that this Commission has ordered that upon firm order by an applicant carrier, the Incumbent Local Exchange Carrier (ILEC) shall provision physical collocation within 90 calendar days or virtual collocation within 60 calendar days (PSC-99-1744-PAA-TP/PSC-99-2393-FOF-TP). These intervals will apply to both caged and cageless collocation as per this Commission's Final Order (PSC-00-0941-FOF-TP) in the Generic Collocation proceeding.

Q. WHAT PROCESS IS IN EFFECT FOR THOSE SITUATIONS SUCH AS MAJOR SYSTEM UPGRADES, DELAYED PERMITS, ETC., THAT MAY NECESSITATE EXTENDING THE PROVISIONING INTERVALS?

A. The FPSC has ordered that there is no reason for the provisioning intervals established by the Commission to be extended without agreement by the ALEC or without the filing of a request for an extension of time by the ILEC. In FPSC Order No. PSC-99-1744-PAA-TP, the Commission required that if an ILEC believed it would be unable to meet the applicable time frame, and the parties were unable to agree to an extension, the ILEC must seek an extension of time from the Commission within 45 calendar days of receipt of the firm order.

1
2
3
4
5
6
7
8
9
10
11
12
13
14
15
16
17
18
19
20
21
22
23
24
25

BellSouth has attempted to refine its processes to accommodate the types of issues that have arisen as a result of various government agencies' involvement. BellSouth has been increasingly successful in working with the various governmental agencies in reducing the permit approval interval. Further, BellSouth is communicating with the ALECs so that they have a good understanding of the issues faced in processing a collocation request.

Issue 19: When AT&T and BellSouth have adjoining facilities in a building outside BellSouth's central office, should AT&T be able to purchase cross-connect facilities to connect to BellSouth or other ALEC networks without having to collocate in BellSouth's portion of the building?

Q. WHAT IS BELLSOUTH'S POSITION ON THIS ISSUE?

A. AT&T's proposal has the effect of expanding the definition of premises beyond that which is required by the FCC regulations or that which is necessary. AT&T simply wishes to take advantage of its former corporate ownership of BellSouth. BellSouth's agreement to AT&T's terms would cause BellSouth to provide AT&T with more favorable treatment than to other local service providers. AT&T has suggested that it use cross connects between its equipment in AT&T's premises with BellSouth's equipment in the BellSouth central office. The type

1 building AT&T is referring to might be thought of as a condominium
2 arrangement because AT&T's part and BellSouth's part adjoin each
3 other and sometimes have special conduits or other structures
4 between the two parts. However, AT&T's part of the building is not
5 part of BellSouth's premises. So what AT&T is really asking for is a
6 new form of interconnection which only AT&T could use since only
7 BellSouth and AT&T have this situation. However, the recent decision
8 by the United States Court of Appeals for the District of Columbia
9 Circuit (Argued February 2, 2000, Decided March 17, 2000, No.
10 99-1176) addresses the issue of ILEC obligations to provide cross-
11 connects and held that ILECs are required to provide collocation so
12 long as that collocation was on the ILEC's premises. Following is the
13 text from that decision regarding cross connects:

14
15 One clear example of a problem that is raised by the
16 breadth of the Collocation Order's interpretation of "neces-
17 sary" is seen in the Commission's rule requiring LECs to
18 allow collocating competitors to interconnect their equipment
19 with other collocating carriers. See Collocation Order, 14
20 FCC Rcd at 4780 p 33 ("We see no reason for the incumbent
21 LEC to refuse to permit the collocating carriers to cross-
22 connect their equipment, subject only to the same reasonable
23 safety requirements that the incumbent LEC imposes on its
24 own equipment."). The obvious problem with this rule is that
25 the cross-connects requirement imposes an obligation on

1 LECs that has no apparent basis in the statute. Section
2 251(c)(6) is focused solely on connecting new competitors to
3 LECs' networks. In fact, the Commission does not even
4 attempt to show that cross-connects are in any sense "neces-
5 sary for interconnection or access to unbundled network
6 elements." Rather, the Commission is almost cavalier in
7 suggesting that cross-connects are efficient and therefore
8 justified under s 251(c)(6). This will not do. The statute
9 requires LECs to provide physical collocation of equipment as
10 "necessary for interconnection or access to unbundled net-
11 work elements at the premises of the local exchange carrier,"
12 and nothing more. As the Supreme Court made clear in
13 Iowa Utilities Board, the FCC cannot reasonably blind itself
14 to statutory terms in the name of efficiency. Chevron defer-
15 ence does not bow to such unbridled agency action. [Emphasis
16 added]

17
18 Q. HOW DID THE RECENT CIRCUIT COURT DECISION ADDRESS
19 COLLOCATION ON LEC'S PROPERTY?

20
21 A. Following is the text from the decision by the United States Court of
22 Appeals for the District of Columbia Circuit:

23
24 The FCC offers no good reason to explain why a competitor, as
25 opposed to the LEC, should choose where to establish

1 collocation on the LEC's' property; nor is there any good
2 explanation of why LECs are forbidden from requiring
3 competitors to use separate entrances to access their own
4 equipment; nor is there any reasonable justification for the rule
5 prohibiting LECs from requiring competitors to use separate or
6 isolated rooms or floors. It is one thing to say that LECs are
7 forbidden from imposing unreasonable minimum space
8 requirements on competitors; it is quite another thing, however,
9 to say that competitors, over the objection of LEC property
10 owners, are free to pick and choose preferred space on the
11 LECs' premises, subject only to technical feasibility. There is
12 nothing in s251(c)(6) that endorses this approach. The statute
13 requires only that the LECs reasonably provide space for
14 "physical collocation of equipment necessary for interconnection
15 or access to unbundled network elements at the premises of the
16 local exchange carrier," nothing more.

17
18 Even if the FCC were to find that cross-connects are "necessary for
19 interconnection or access to unbundled network elements", it is clear
20 to me that such a requirement that BellSouth provide cross-connects is
21 limited to the situation where an ALEC such as AT&T is collocated
22 within the BellSouth premise. My reading of the Circuit Court's
23 decision in no way creates a requirement that BellSouth provide AT&T
24 with cross-connects in lieu of other forms of interconnection between
25 AT&T's network and BellSouth's network.

1
2
3
4
5
6
7
8
9
10
11
12
13
14
15
16
17
18
19
20
21
22
23
24
25

Q. HAS THIS COMMISSION ADDRESSED THE ISSUE OF CROSS-CONNECTS BETWEEN COLLOCATORS?

A. Yes. In Docket Nos. 981834-TP and 990321-TP, the Commission's Staff recommended as follows:

Staff recommends that BellSouth's and GTEFL's Motions for reconsideration regarding the Commission's decision on cross-connects between collocators be granted. The FCC's Order 99-48 and the FCC Rules upon which the Commission relied for its decision on this point have been vacated by the DC Circuit. In view of the fact that a federal court has now rendered an interpretation of federal law that is directly contrary to this Commission's interpretation on this point may be considered in error. In conformance with the Court's decision, the Commission should find that ILECs are not required to allow collocators to cross-connect within a CO. Staff recommends, however, that ILECs be encouraged to consider requests by ALECs for permission to cross-connect.

At the October 17, 2000, Agenda Conference, this Commission approved the Staff's recommendation on this issue.

1 **Issue 20: Is conducting a statewide investigation of criminal history**
2 **records for each AT&T employee or agent being considered to work on**
3 **a BellSouth premises a security measure that BellSouth may impose on**
4 **AT&T?**

5

6 Q. WHAT IS YOUR UNDERSTANDING OF THE DISPUTE BETWEEN
7 BELLSOUTH AND AT&T IN ISSUE 20?

8

9 A. AT&T and BellSouth disagree as to what security measures are
10 necessary to protect BellSouth's network when AT&T's employees or
11 agents are given unescorted access to BellSouth's premises.

12

13 Q. WHAT IS BELLSOUTH'S POSITION ON THIS ISSUE?

14

15 A. BellSouth performs criminal background checks on its employees prior
16 to hiring. AT&T should do the same in order for AT&T's employees or
17 agents who enjoy unescorted access to BellSouth's central offices and
18 other premises. Such security requirements are reasonable in light of
19 the impact on public safety and the assets being protected as well as
20 the number of new entrants and other telecommunications carriers
21 who rely on the integrity and reliability of BellSouth's network. AT&T's
22 offer to indemnify BellSouth for bodily injury or property damage is not
23 sufficient in light of the asset at risk. Indemnification is an after the fact
24 solution. By requiring criminal background investigations, BellSouth is
25 seeking to protect the consumer and other ALECs up front from the

1 incumbent risks.

2

3 Although there have been no formal discussions, BellSouth is willing to
4 agree that it would be acceptable whereby any employees hired by
5 AT&T prior to January 1, 1995, would not be required to have criminal
6 background checks. That is, of course, assuming AT&T assures
7 BellSouth of no criminal activity on the part of the employee since that
8 time.

9

10 Q. DESCRIBE THE SPECIFIC SECURITY CHECKS BELLSOUTH
11 REQUIRES OF ITS EMPLOYEES, VENDORS, AND OTHER
12 AGENTS THAT ARE IN EFFECT TODAY.

13

14 A. BellSouth requires a seven (7) year criminal background check for all
15 of its employees prior to hiring, and a five (5) year criminal background
16 check for vendors and agents.

17

18 Q. ARE THERE ANY OTHER SPECIFIC REQUIREMENTS THAT THE
19 ALEC SHOULD CONSIDER WHEN ASSIGNING VENDORS AND
20 AGENTS TO BELLSOUTH'S PREMISES?

21

22 A. Yes. The ALEC should not knowingly assign to BellSouth's premises
23 any individual who was a former employee of BellSouth and whose
24 employment with BellSouth was terminated for a criminal offense

1 whether or not BellSouth sought prosecution of the individual for the
2 criminal offense.

3
4 Also, the ALEC should not knowingly assign to BellSouth's premises
5 any individual who was a former contractor of BellSouth and whose
6 access to BellSouth's premises was revoked due to commission of a
7 criminal offense whether or not BellSouth sought prosecution of the
8 individual for the criminal offense.

9
10 **Q. DOES BELLSOUTH MEET THE FCC'S REQUIREMENT THAT**
11 **PERMITS COLLOCATORS DIRECT ACCESS TO ITS EQUIPMENT**
12 **WITHOUT BEING ESCORTED BY BELLSOUTH PERSONNEL AND**
13 **WITHOUT THE COLLOCATOR'S EQUIPMENT BEING PHYSICALLY**
14 **SEPARATED BY A WALL OR OTHER STRUCTURE FROM**
15 **BELLSOUTH'S EQUIPMENT OR THE EQUIPMENT OF OTHER**
16 **ALECs?**

17
18 **A. Yes. However, the FCC's Order raises serious concerns that must be**
19 **addressed in order to retain the level of network reliability and security**
20 **that currently exists and which end users and regulators have come to**
21 **expect. BellSouth has addressed those concerns and is compliant**
22 **with the FCC's requirements. A simple reading of today's newspaper**
23 **headlines reveals the need for stringent control over the access to and**
24 **operation of the public telephone network. In order to provide**
25 **reasonable security measures, BellSouth requires that all collocators'**

1 employees and agents undergo the same level of security training, or
2 its equivalent, that BellSouth's own employees, or third party
3 contractors providing similar functions, must undergo. Each collocator
4 must provide its employees and agents with picture identification,
5 which must be worn and be visible in the collocation space or other
6 areas in and around BellSouth's central offices. In its Order, the FCC
7 permitted incumbent LECs to impose security arrangements that are
8 as stringent as the security arrangements the incumbent LEC
9 maintains at its premises for its own employees. BellSouth is not
10 requiring ALECs to perform a seven (7) year criminal background
11 investigation, as it does for its own employees. Rather, BellSouth
12 requires only a five (5) year criminal background check of BellSouth's
13 vendors and agents and for collocators' employees or agents.
14 Collocators are required to conduct an investigation of criminal history
15 records for each of the collocator's employees and agents being
16 considered for work within or upon BellSouth's premises. Restrictions
17 are imposed on a collocator's employees or agents with felony or
18 misdemeanor criminal convictions. Also, the FCC's Order provides for
19 additional security measures such as allowing BellSouth to provide a
20 cage around its own equipment. Thus, BellSouth is in compliance with
21 the security provisions required by the FCC's Order.

22

23 Q. DOES BELLSOUTH REQUIRE THAT AT&T PERFORM SECURITY
24 CHECKS OF ALL ITS EMPLOYEES?

25

1 A. No. BellSouth is indifferent to the security measures and background
2 checks AT&T makes for its employees to access its own buildings.
3 However, BellSouth is rightly concerned for proper security measures
4 and background criminal checks for those of AT&T's employees for
5 which AT&T wants unescorted access to BellSouth's premises. If
6 AT&T doesn't want to perform background criminal checks of all of its
7 employees, it need only check those of its employees it wants admitted
8 to BellSouth's premises.

9

10 Q. IS THE CRIMINAL BACKGROUND CHECK PROPOSED BY
11 BELL SOUTH EFFECTIVE IN LIMITING OR RESTRICTING A
12 WORKER FROM HARMING OR DAMAGING PROPERTY?

13

14 A. Yes. Criminal background checks are a reasonable way to prevent
15 known criminals from even being in a place where they could cause
16 harm or damage to BellSouth's or an ALEC's network

17

18 Q. DOES BELL SOUTH'S PROPOSAL IMPOSE DISCRIMINATORY
19 SECURITY REQUIREMENTS ON AT&T THAT IT DOES NOT
20 IMPOSE ON ITSELF?

21

22 A. No. ILECs such as BellSouth are entitled under the FCC's order to
23 "impose reasonable security arrangements to protect their equipment
24 and ensure network security and reliability." Advanced Services Order
25 at paragraph 46. That is all BellSouth's policy is meant to do. Again,

1 BellSouth believes a simple reading of today's newspaper headlines is
2 sufficient to underscore the public's need for secure, reliable
3 communications. BellSouth's security policies are a reasonable
4 balance between giving ALECs unfettered access to BellSouth's
5 premises while maintaining network reliability and security.

6

7 **Issue 21: Unless otherwise specified, where Attachment 4 regarding**
8 **collocation refers to days, should those days be calendar days or**
9 **business days?**

10

11 Q. WHAT IS BELLSOUTH'S POSITION ON THIS ISSUE?

12

13 A. BellSouth accepts the decision of this Commission that intervals will be
14 counted as calendar days. As I discussed in Issue 18, this
15 Commission has already determined an interval, and that interval is to
16 be reflected in calendar days.

17

18 **Issue 23: Has BellSouth provided sufficient customized routing in**
19 **accordance with State and Federal law to allow it to avoid providing**
20 **Operator Services/Directory Assistance ("OS/DA") as a UNE?**

21

22 Q. WHAT IS BELLSOUTH'S POSITION ON THIS ISSUE?

23

24 A. BellSouth has available both an Advanced Intelligent Network (AIN)
25 solution for customized routing as well as the Line Class Code (LCC)

1 solution that was advocated by AT&T during the last round of
2 arbitrations. Thus, BellSouth has met its requirement to provide
3 customized routing and as a result is not obligated to provide access to
4 operator services and directory assistance at UNE rates.

5

6 Q. WHAT DO THE FCC RULES SAY ABOUT ACCESS TO OPERATOR
7 SERVICES AND DIRECTORY ASSISTANCE?

8

9 A. The FCC's Rule 319(f) makes clear that BellSouth is not required to
10 provide access to operator services and directory assistance where it
11 provides ALECs "with customized routing or a compatible signaling
12 protocol."

13

14 Q. WHAT IS CUSTOMIZED ROUTING?

15

16 A. Customized routing (which has also been referred to as selective
17 routing) allows calls from an ALEC's customers served by a BellSouth
18 switch to reach the ALEC's choice of operator service or directory
19 assistance service platforms instead of BellSouth's operator service
20 and directory assistance service platforms. Customized routing can be
21 provided when an ALEC acquires unbundled local switching from
22 BellSouth or resells BellSouth's local exchange services.

23

24 Q. BRIEFLY DESCRIBE THE METHODS AVAILABLE FOR
25 CUSTOMIZED ROUTING.

1
2
3
4
5
6
7
8
9
10
11
12
13
14
15
16
17
18
19
20
21
22
23
24
25

A. The first method of providing customized routing that BellSouth has made available is the Line Class Code (LCC) method. The LCC method makes use of translations and routing capabilities in the end office switch. Availability of customized routing capability using LCCs is offered on a first-come, first-served basis. To date, BellSouth has not denied any request for selective routing based on lack of LCC capacity.

Q. IS THERE A LIMITATION ON THE AVAILABILITY OF CUSTOMIZED ROUTING FOR ALECs?

A. No. Although BellSouth originally believed (based on representations by AT&T and other ALECs) that ALEC demands for customized routing would exhaust available LCCs, demands to date do not suggest imminent risk of exhaustion of LCCs. However, even were that to occur (which I do not believe will in fact occur), the AIN solution discussed below would still be available. The AIN method eliminates any potential exhaust concerns about the LCC method of customized routing.

Q. PLEASE DESCRIBE THE SECOND METHOD BY WHICH BELL SOUTH PROVIDES CUSTOMIZED ROUTING.

A. The second method for providing customized routing is through the

1 use of BellSouth's AIN platform. A technical trial of customized routing
2 using BellSouth's AIN platform commenced in Louisiana, in August
3 1998, and was successfully completed in September 1998. A second
4 trial commenced from May 1999 and successfully completed in August
5 1999.

6
7 The AIN method for customized routing is available to ALECs in
8 addition to the LCC method. BellSouth has completed work on
9 enhancements to its AIN Service Management System (SMS) which
10 will facilitate ALEC's creating and updating routing information for the
11 ALEC's end user customers. BellSouth completed end-to-end testing
12 (ETET) of this enhancement on June 14, 2000. BellSouth anticipates
13 offering this enhanced method in the fourth quarter 2000.

14
15 By providing ALECs a choice of methods, BellSouth better enables
16 ALECs to compete based upon their own business plans and priorities.

17
18 Q. ARE BOTH METHODS PROPOSED BY BELL SOUTH AVAILABLE
19 TODAY?

20
21 A. Yes. Both the LCC method and the AIN method are available today.
22 The LCC method is available to ALECs in addition to BellSouth's AIN
23 version and both have been tested and proved workable. If AT&T
24 wants to use the LCC method, it merely needs to order it. Insofar as
25 tests are concerned, AT&T itself participated in cooperative testing of

1 BellSouth's AIN method for customized routing in 1997. Later
2 BellSouth offered to do a trial of the AIN method in Louisiana yet not
3 one ALEC, not even AT&T, showed the slightest interest in being part
4 of that trial. As with the LCC method, if AT&T wants to use the AIN
5 method, it merely needs to order it.

6

7 **Q. USING THE AIN SOLUTION, WOULD POST-DIALING DELAY**
8 **DURING CALL SETUP CREATE A CONCERN?**

9

10 **A. No. First of all, post dialing delay is the time between when the end**
11 **user finishes dialing and when the customer is informed (via ringing**
12 **signal, busy tone or the like) of the call's progress. All switching**
13 **systems take some time to translate the dialed digits, select an**
14 **appropriate trunk group and the like, and all these functions contribute**
15 **to post dialing delay. So, post dialing delay is not an artifact of**
16 **BellSouth's AIN customized routing solution. With the AIN solution, a**
17 **computer database is queried during call processing to determine the**
18 **ALEC's preferred routing for a particular end user. This database**
19 **query takes time and thus adds a small incremental bit of post dialing**
20 **delay to the overall processing of the call. Second, BellSouth believes**
21 **the post dialing delay will be only about one second. Third, if AT&T is**
22 **concerned with even that small an amount of post dialing delay, AT&T**
23 **can simply request the Line Class Code method and thereby eliminate**
24 **its concerns for post dialing delay.**

25

1 Q. WHY DOES BELLSOUTH CHOOSE TO PERFORM THE DATABASE
2 QUERY FROM THE AIN HUB RATHER THAN FROM EACH AND
3 EVERY END OFFICE SWITCH?
4

5 A. The AIN method of customized routing allows the use of the AIN "hub"
6 concept, which yields several advantages as follows:

- 7 • Allows the use of appropriate AIN "triggers" for all call types
8 rather than only a limited set of call types.
- 9 • Allows even those end office switches that are not AIN-capable
10 to use the AIN customized routing solution.
- 11 • Optimizes the use of trunk groups by allowing the carriage of
12 customized routing traffic over common trunk groups between
13 the end office switch and the AIN hub.

14

15 Thus, the AIN hubbing arrangement allows the use of the AIN method
16 in all switches, even those that are not AIN capable. Also, the AIN
17 hubbing arrangement allows some sharing of common trunk groups
18 that other ALECs have stated they prefer.

19

20 Q. HAS BELLSOUTH PROVIDED SUFFICIENT INFORMATION SUCH
21 AS ORDERING INSTRUCTIONS AND SUPPORTING
22 DOCUMENTATION TO AT&T FOR EACH OF THE CUSTOMIZED
23 ROUTING OPTIONS THAT BELLSOUTH WILL PROVIDE?
24

25 A. BellSouth has provided AT&T with a proposed contract language

1 addition for procedures for customized routing. (Attachment 7, Section
2 3.20 et seq.) This proposed language will provide specific ordering
3 procedures and documentation as requested by AT&T. If AT&T wants
4 the Line Class Code method of customized routing because AT&T
5 prefers it over the AIN method, AT&T should simply order the Line
6 Class Code method which is and has long been available to it.

7

8 Q. DOES BELLSOUTH HAVE AN OBLIGATION TO ROUTE OS/DA
9 CALLS USING EXISTING TANDEM ARCHITECTURE?

10

11 A. No. BellSouth has no obligation to route AT&T's operator services and
12 directory assistance traffic differently than BellSouth routes its own
13 operator services and directory assistance traffic. I am unaware of any
14 requirement that BellSouth route an ALEC's operator services and
15 directory assistance traffic via tandem. Further, that is not how
16 BellSouth routes its own operator services and directory assistance
17 traffic. Instead, BellSouth uses direct trunk groups between
18 BellSouth's end office switches and BellSouth's operator services and
19 directory assistance platforms. However, BellSouth will provide
20 unbundled tandem switching to AT&T and AT&T can use that
21 capability as it chooses, subject only to the technical capabilities of the
22 tandem switch.

23

24 Q. DOES BELLSOUTH HAVE AN OBLIGATION THAT ITS
25 CUSTOMIZED ROUTING ARCHITECTURE MUST BE FULLY

1 IMPLEMENTED AND AVAILABLE IN EVERY END OFFICE WHERE
2 TECHNICALLY FEASIBLE?

3

4 A. No. It would not be a wise decision for BellSouth to spend money to
5 equip each and every one of its end office switches for customized
6 routing on the chance that an ALEC, such as AT&T, might someday
7 order customized routing. BellSouth has no obligation to spend its
8 money in such a way. If, on the other hand, an ALEC, such as AT&T,
9 requests customized routing in each and every end office switch,
10 BellSouth will gladly fulfill that request.

11

12 Q. CAN BELLSOUTH'S CUSTOMIZED ROUTING SOLUTIONS, WHICH
13 INCLUDE BRANDED AND UNBRANDED RESPONSES, BE
14 PROVISIONED IN A SHORT TIME FRAME?

15

16 A. Yes. BellSouth's customized routing solutions can be provisioned
17 promptly and can handle both branded and unbranded responses to
18 end users' calls. AT&T need only place an order with BellSouth for
19 customized routing and BellSouth will provide it.

20

21 **Issue 25: What procedure should be established for AT&T to obtain**
22 **loop-port combinations (UNE-P) using both Infrastructure and Customer**
23 **Specific Provisioning?**

24

1 Q. WITH REGARD TO THE ISSUE OF USING LCCs FOR OS/DA
2 ROUTING, WHAT IS YOUR UNDERSTANDING OF WHAT AT&T
3 WANTS WITH REGARD TO THIS ISSUE?
4

5 A. BellSouth thinks that what AT&T is addressing is the fact that when a
6 BellSouth retail customer orders service, BellSouth defaults the
7 customer to BellSouth's own branded operation and directory services.
8 BellSouth believes that AT&T is asking BellSouth to create a situation
9 where AT&T too can have a default for its customers. That is, AT&T
10 could tell BellSouth that all of AT&T's customers should be routed to
11 an AT&T OS/DA platform, unless otherwise instructed. Alternatively,
12 AT&T could decide to tell BellSouth to route all of AT&T's traffic, unless
13 otherwise instructed, to an unbranded BellSouth OS/DA platform. If
14 this is what AT&T really wants, then BellSouth only has two issues.
15 The first is to set the level at which such instructions have to be given.
16 That is, will this default plan only apply to the region as a whole, on a
17 state-by-state basis, or perhaps on a different level. I will speak to this
18 more in a moment. Second, once the appropriate level for applying the
19 default is determined, AT&T has to tell us what the default will be. To
20 date, both of these issues have remained unresolved.
21

22 Q. WHAT IS NECESSARY FOR BELL SOUTH TO FULFILL AT&T'S
23 ORDERS FOR CUSTOMIZED ROUTING?
24

25 A. In its Order responding to BellSouth's second Louisiana 271

1 application (Louisiana II), the FCC stated that if an ALEC informed an
2 ILEC of its single set of routing instructions, that the ILEC rather than
3 the ALEC could determine the appropriate Line Class Code to use in
4 for a given order. Following is the FCC's statement in paragraph 224
5 of its Louisiana II order:

6
7 We agree with BellSouth, that a competitive LEC must tell
8 BellSouth how to route its customers' calls. If a competitive
9 LEC wants all of its customer calls routed in the same way, it
10 should be able to inform BellSouth, and BellSouth should be
11 able to build the corresponding routing instructions into its
12 systems just as BellSouth has done for itself. If, however, a
13 competitive LEC has more than one set of routing instructions for
14 its customers, it seems reasonable and necessary for BellSouth
15 to require the competitive LEC to include in its order an indicator
16 that will inform BellSouth which selective routing pattern to use.
17 [Emphasis added]

18
19 To this point, no single routing instruction has been given to BellSouth
20 by AT&T.

21
22 BellSouth has no problem with the FCC's position, provided a single
23 routing instruction is given as the default. Line Class Codes are
24 assigned based on factors such as assigned class of service and the
25 routing desired by the ALEC for a given end user. I would note that

1 AT&T could decide to treat two single-party residential customers
2 differently in terms of how those customers' calls to operator services
3 or directory assistance are handled. For one customer, AT&T could
4 decide that the customer's calls to operator services and directory
5 assistance were to be handled on an unbranded basis using
6 BellSouth's operators. For the second customer, AT&T could decide
7 that the customer's calls to operator services and directory assistance
8 were to be routed to AT&T's own operators for special treatment. Both
9 these arrangements are possible but obviously only AT&T knows how
10 it wants each of its customers treated. If AT&T wants to call one of
11 these patterns its "default" pattern and then change the default for the
12 second customer, that's fine. But AT&T needs to tell BellSouth what it
13 wants to do in the first instance.

14

15 **Q. WHAT SPECIFIC INPUT DOES AT&T NEED TO PROVIDE TO**
16 **BELLSOUTH ?**

17

18 **A. First, AT&T needs to provide BellSouth with an indicator in its order for**
19 **customized routing that would inform BellSouth how to "map" or route**
20 **AT&T's customer to AT&T's choice of handling (branded, unbranded,**
21 **etc.). Obviously, only AT&T knows how it wants each of its customers**
22 **treated. Once an agreed upon default routing plan is established, the**
23 **appropriate LCC could be assigned to individual customer orders.**

24

1 **Second, AT&T needs to discuss with BellSouth the geographic scope**
2 **of its default routing plan (region, state, LATA, etc.) so BellSouth can**
3 **construct the required translations tables. In paragraph 224 of the**
4 **FCC's Louisiana II order, it states that if an ALEC has more than one**
5 **set of routing instructions for all its customers, it would be appropriate**
6 **for BellSouth to require the ALEC to include in the ALEC's order an**
7 **indicator that would inform BellSouth which selective routing pattern to**
8 **use. This would imply application on a region-wide basis. Thus,**
9 **BellSouth believes the FCC intended for an ALEC to have a default**
10 **routing plan for the entire region. To be as granular as to establish**
11 **routing patterns for each BellSouth end office must surely be "more**
12 **than one set of routing instructions". In addition, having different**
13 **default routing plans for each central office would not be practical as**
14 **BellSouth has more than 1,600 central offices in its nine-state region.**

15
16 **Q. IS BELLSOUTH WILLING TO DO WHAT AT&T WANTS?**

17
18 **A. Yes, provided AT&T tells BellSouth what it actually wants and the**
19 **request is reasonable. Having one set of default routing instructions**
20 **for all of AT&T's customers in BellSouth's nine-state region is**
21 **reasonable. Having over 1,600 sets of default routing instructions (that**
22 **is, one for each BellSouth central office) is not reasonable.**

23
24 **Q. HAS AT&T GIVEN BELLSOUTH A DEFAULT ROUTING PLAN FOR**
25 **AT&T's CUSTOMERS?**

1

2 A. No. Instead of committing to a single routing plan as contemplated by
3 the FCC's Order, AT&T still insists that routing decisions (and thus
4 assignment of Line Class Codes) are situational and that AT&T will
5 decide on a routing pattern by end office, by LATA, or by state, at
6 AT&T's option. Thus it is clear that even now AT&T has no single
7 default routing plan that it can or will convey to BellSouth that is
8 instructive of how certain customers are to be handled. So AT&T
9 wants BellSouth to read AT&T's mind and assign Line Class Codes
10 correctly. This is simply not possible. If AT&T will commit to the single
11 default routing plan contemplated by the FCC in its Louisiana II order
12 and will inform BellSouth of its routing plan, then and only then can
13 BellSouth correctly assign Line Class Codes on AT&T's orders.

14

15 Q. WHAT DOES BELLSOUTH PROPOSE TO RESOLVE THIS ISSUE?

16

17 A. BellSouth asks this Commission to affirm that it has met its
18 requirements for providing customized routing and that BellSouth is not
19 required to provide operator services and directory assistance as
20 unbundled network elements at cost based rates.

21

22 Q. DOES THIS CONCLUDE YOUR TESTIMONY?

23

24 A. Yes.

Typical existing serving arrangement

BellSouth Telecommunications, Inc.
Florida Public Service Commission
Docket No. 000731-TP
Exhibit WKM-1
Page 1 of 3

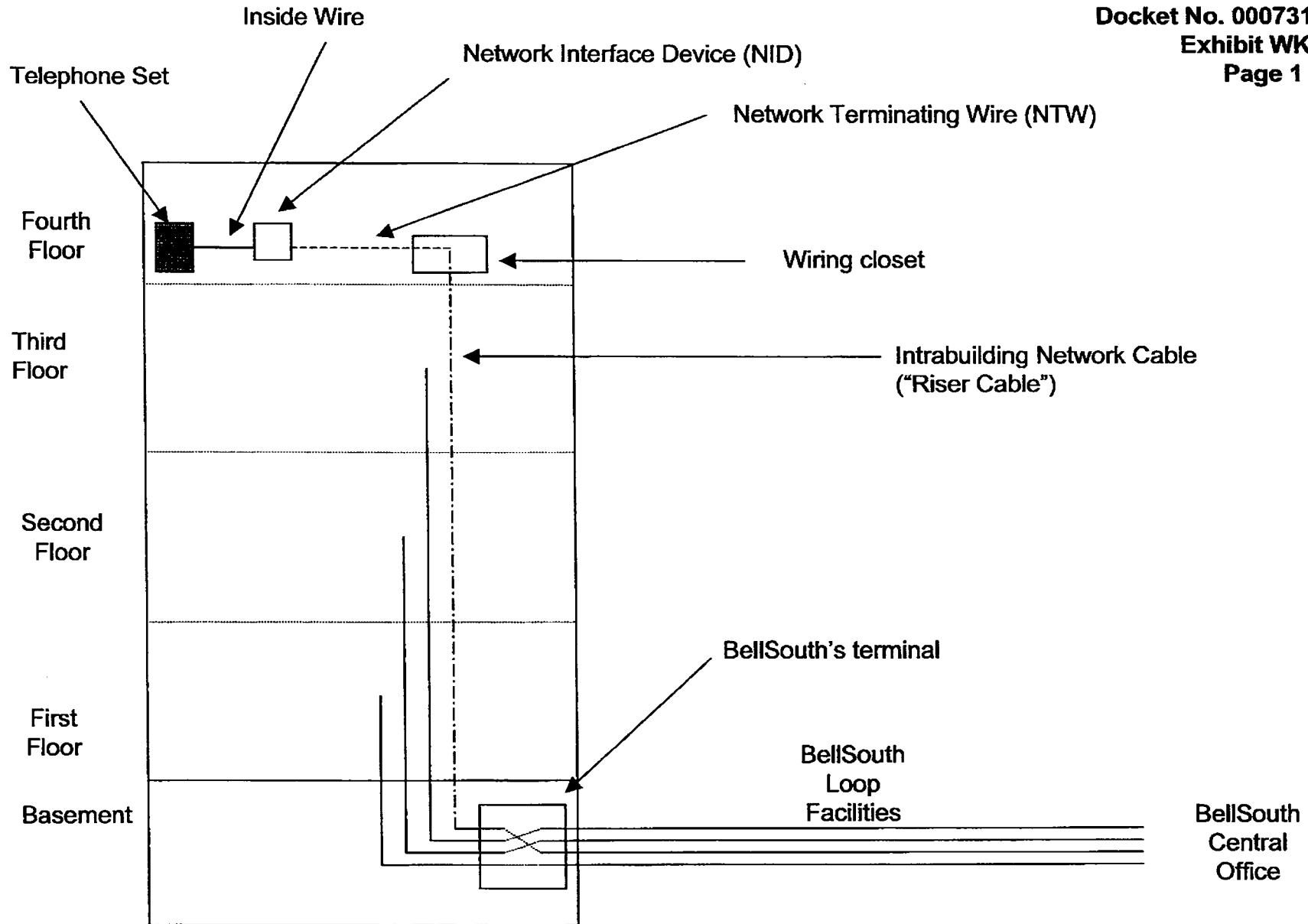

BellSouth's proposed form of access

BellSouth Telecommunications, Inc.
Florida Public Service Commission
Docket No. 000731-TP
Exhibit WKM-1
Page 2 of 3

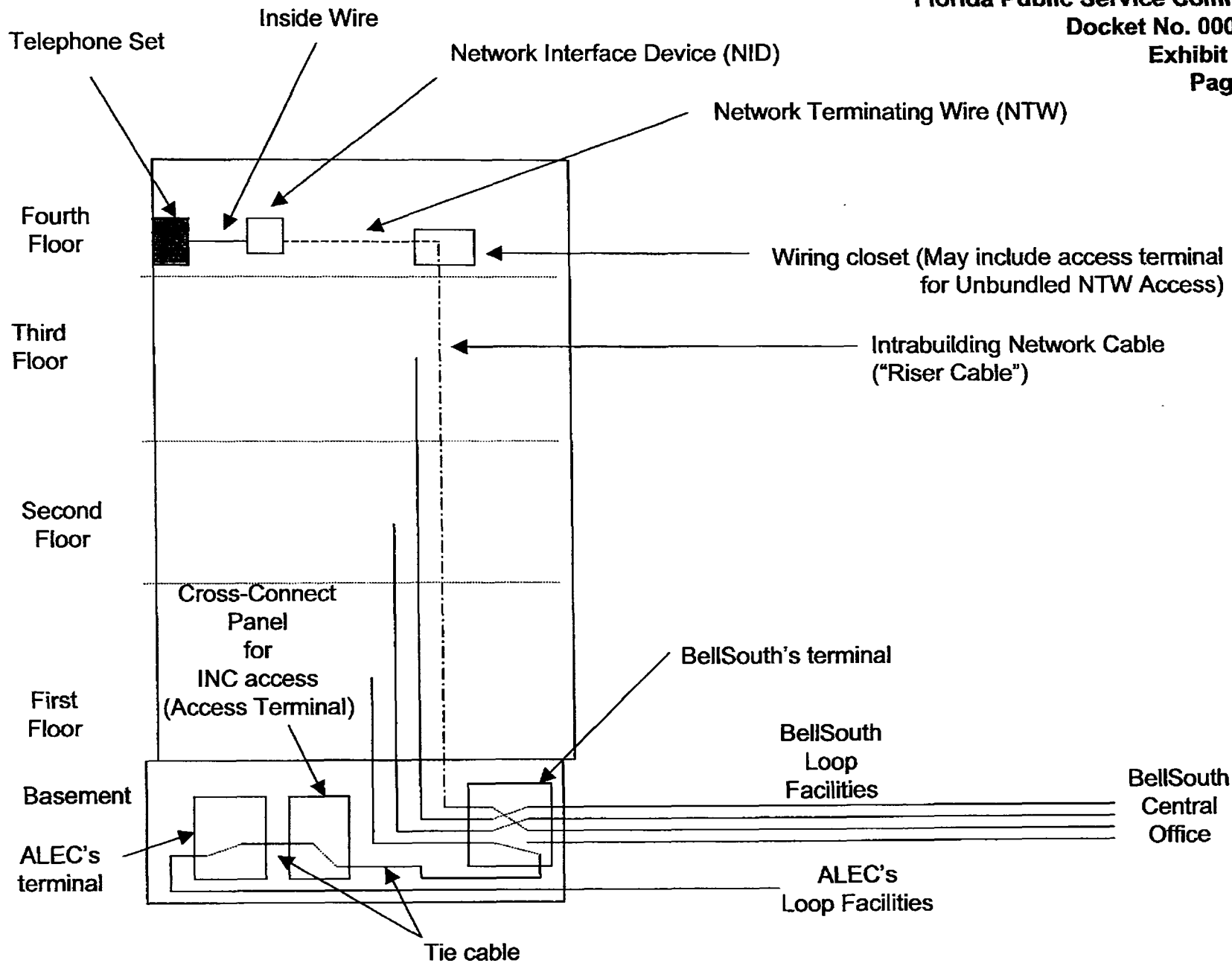

**Typical access to unbundled network terminating wire
in "garden" apartment**

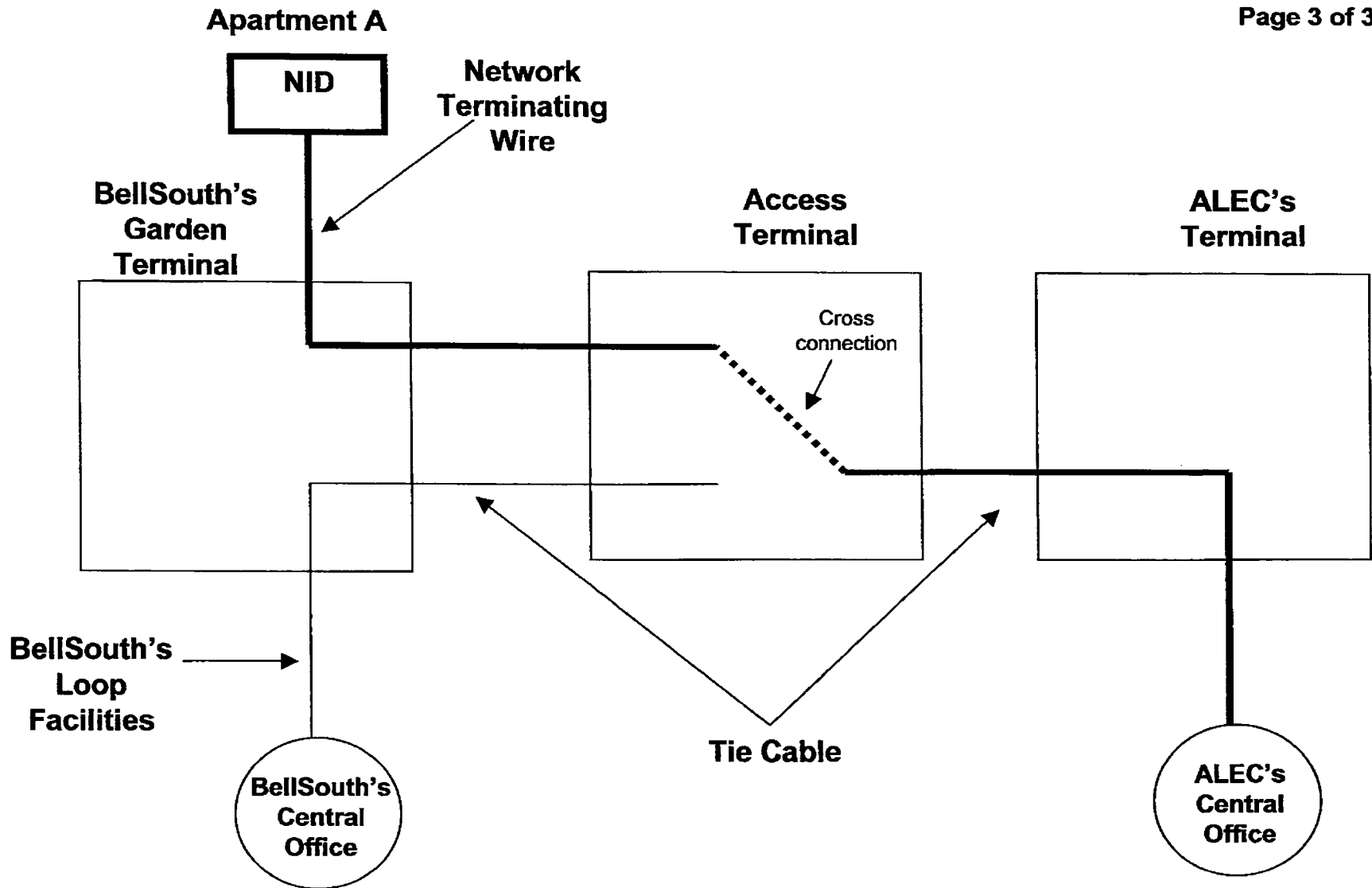

LOOP CUTOVER PROCESS

Step 1: Technician gets call to begin cutover. Asks for cable pair information.

BellSouth Telecommunications, Inc.

Florida Public Service Commission

Docket No.000731-TP

Exhibit WKM-2

Page 1 of 14

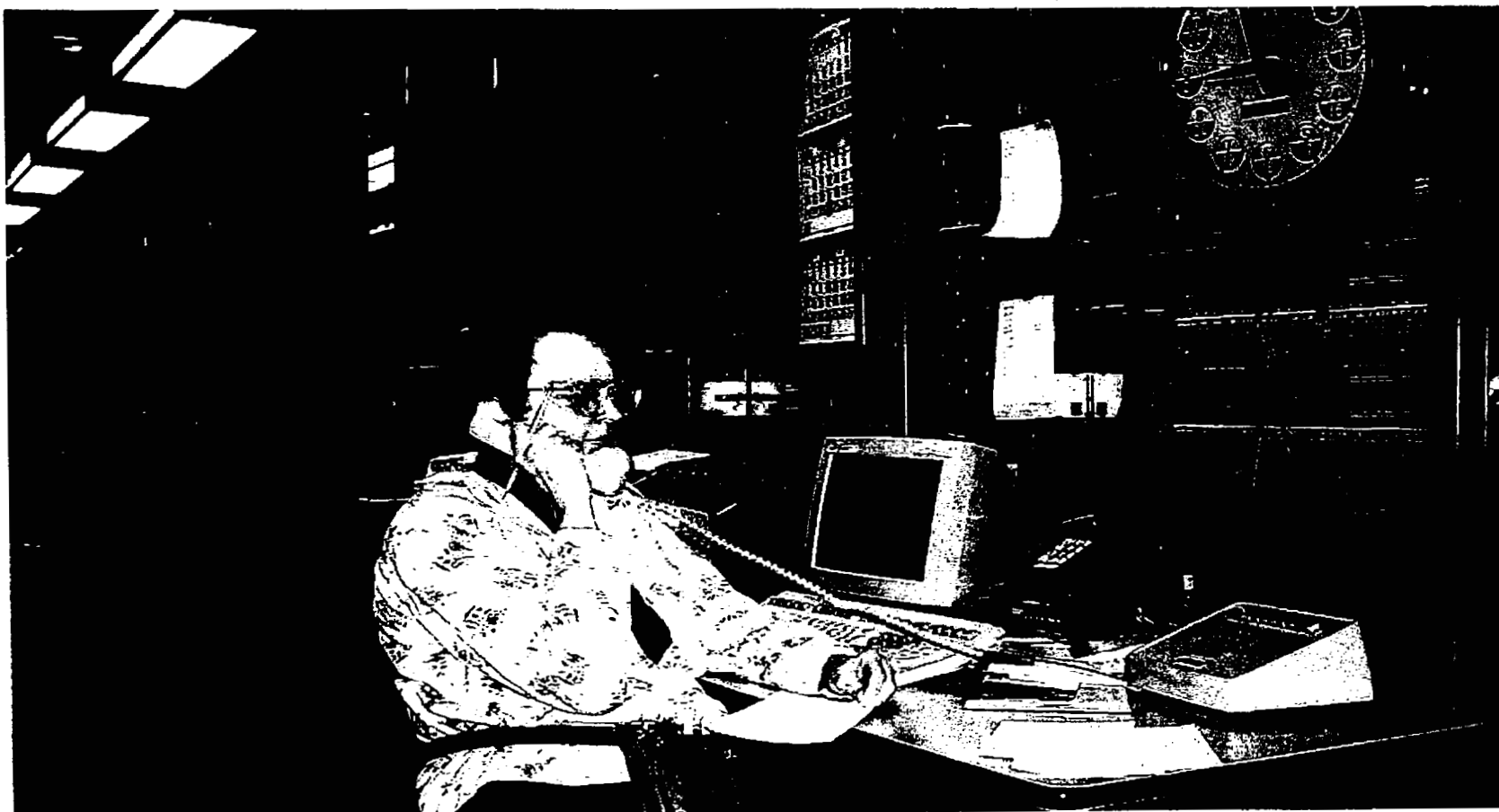

LOOP CUTOVER PROCESS

Step 2: Technician types in cable pair number to obtain order number.



LOOP CUTOVER PROCESS

Step 3: Technician retrieves copy of work order.





LOOP CUTOVER PROCESS
Step 4: Technician responds to UNE Center
request to initiate overall cutover of service
from BellSouth to ALEC.

LOOP CUTOVER PROCESS

Step 5: Technician conducts ANAC test to verify that correct loop is being cutover.



LOOP CUTOVER PROCESS

Step 6: Technician walks along Main Distributing Frame to locate both ends of jumper to be cut.



LOOP CUTOVER PROCESS

Step 7: Technician locates precise location of jumper.



LOOP CUTOVER PROCESS

Step 8: Technician locates and removes end of jumper connected to the BellSouth cable pair.

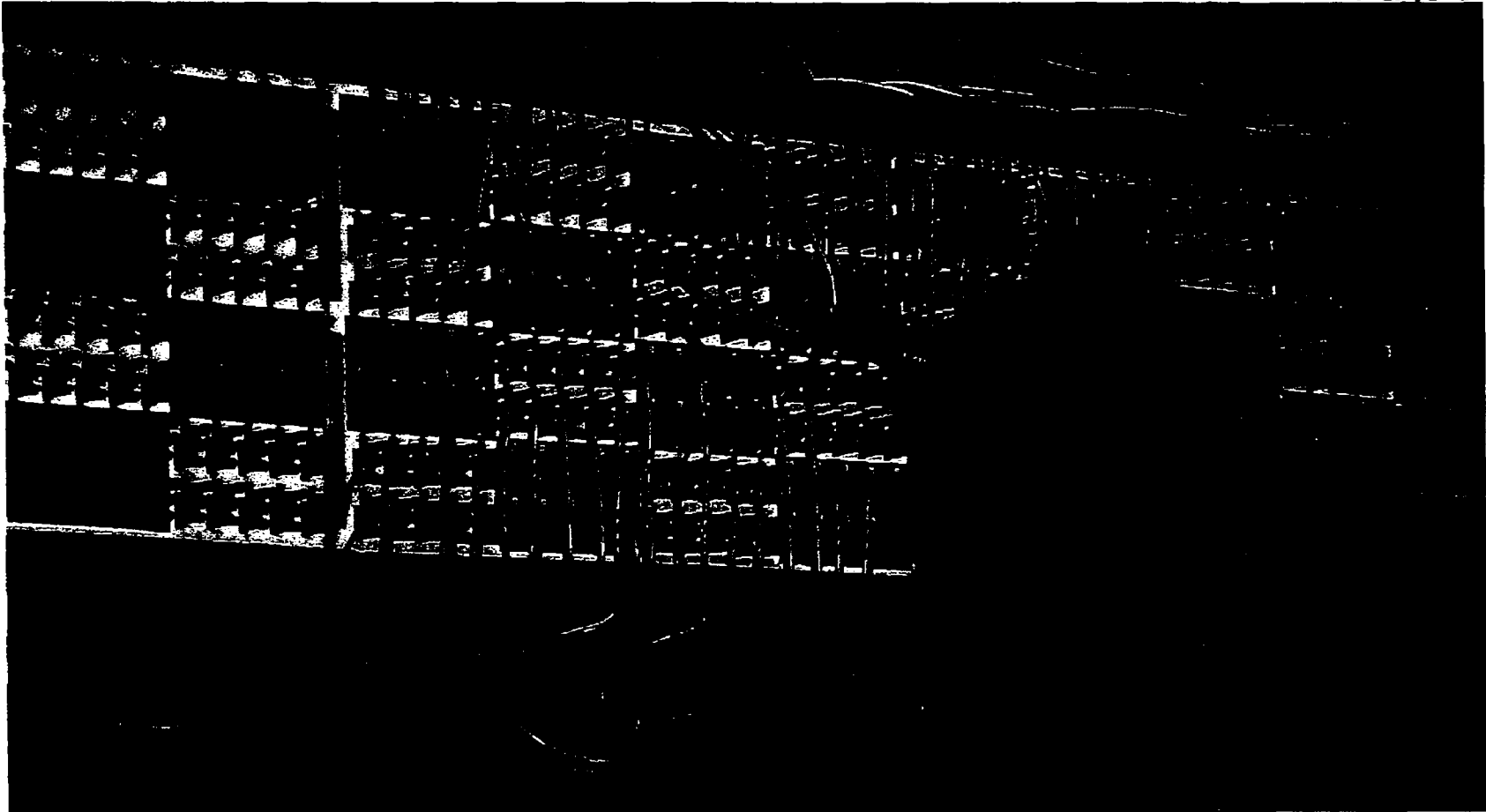

LOOP CUTOVER PROCESS

Step 9: Technician locates and removes end of jumper connected to the switching equipment.

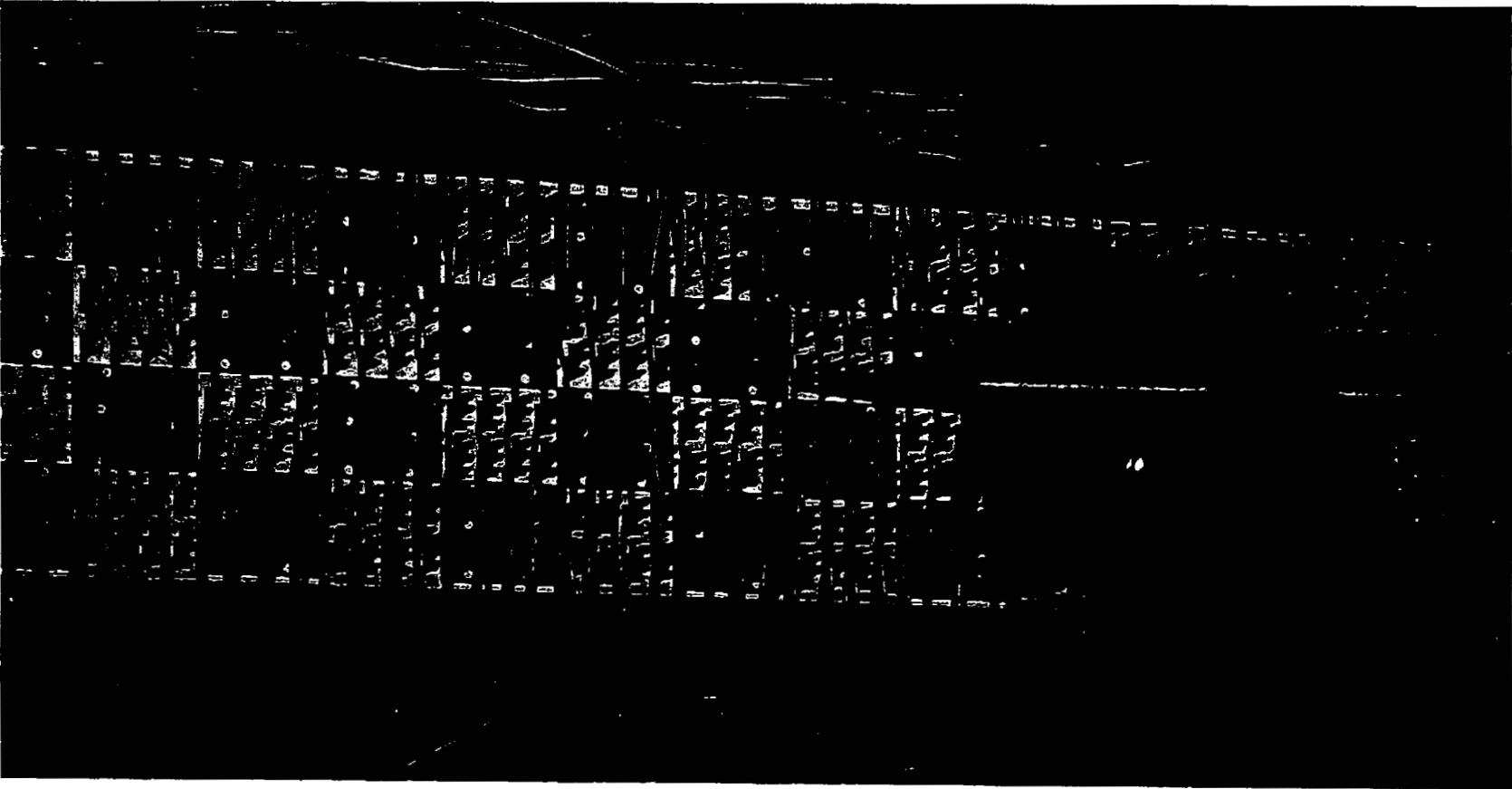

BellSouth Telecommunications, Inc.
Florida Public Service Commission

LOOP CUTOVER PROCESS

Docket No.000731-TP

Step 10: Technician places new jumper on MDF.

Exhibit WKM-2

Page 10 of 14

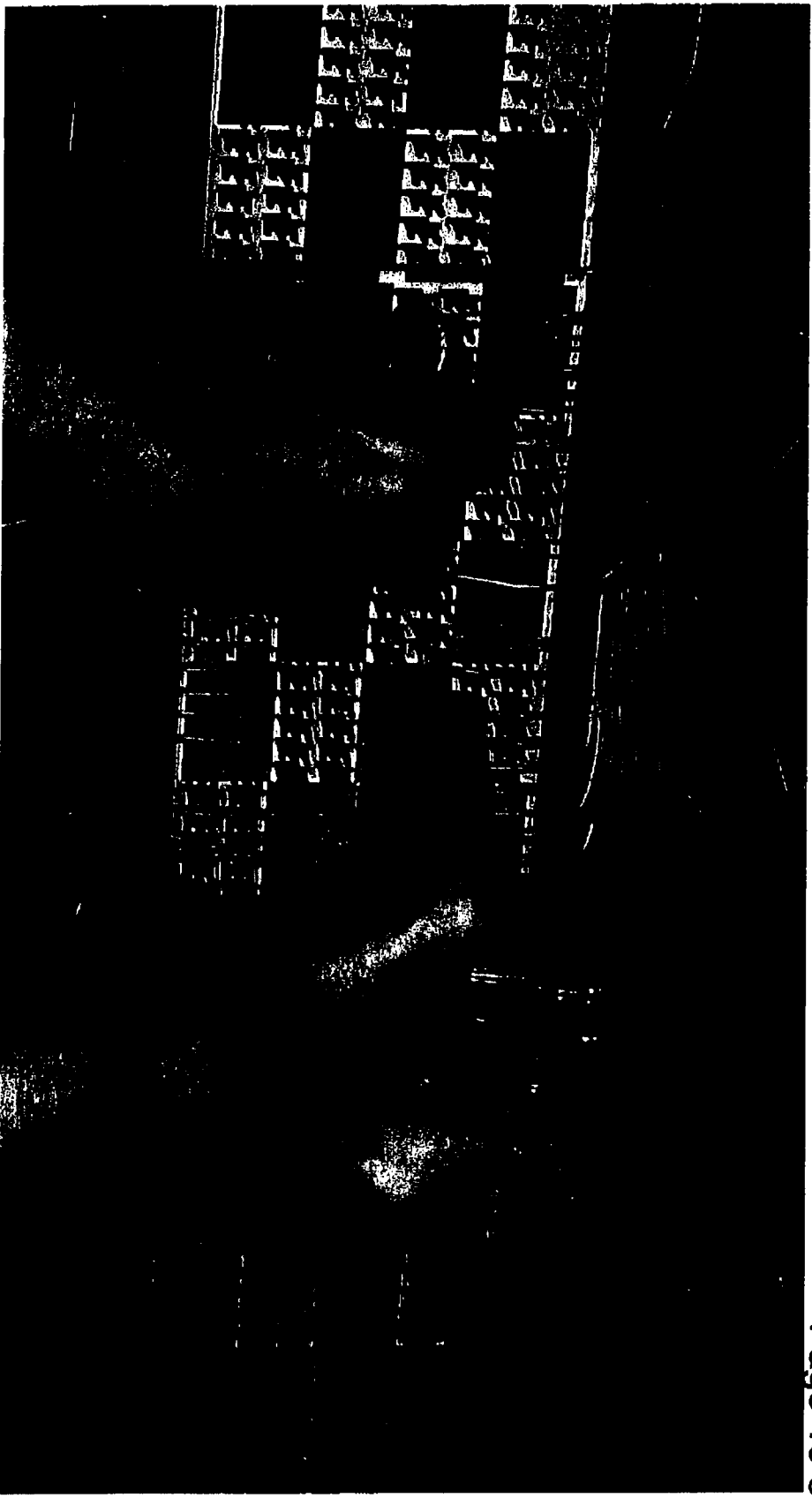

LOOP CUTOVER PROCESS

Step 11: Technician weaves wire through cable rack to reach tie cable to ALEC's collocation equipment.

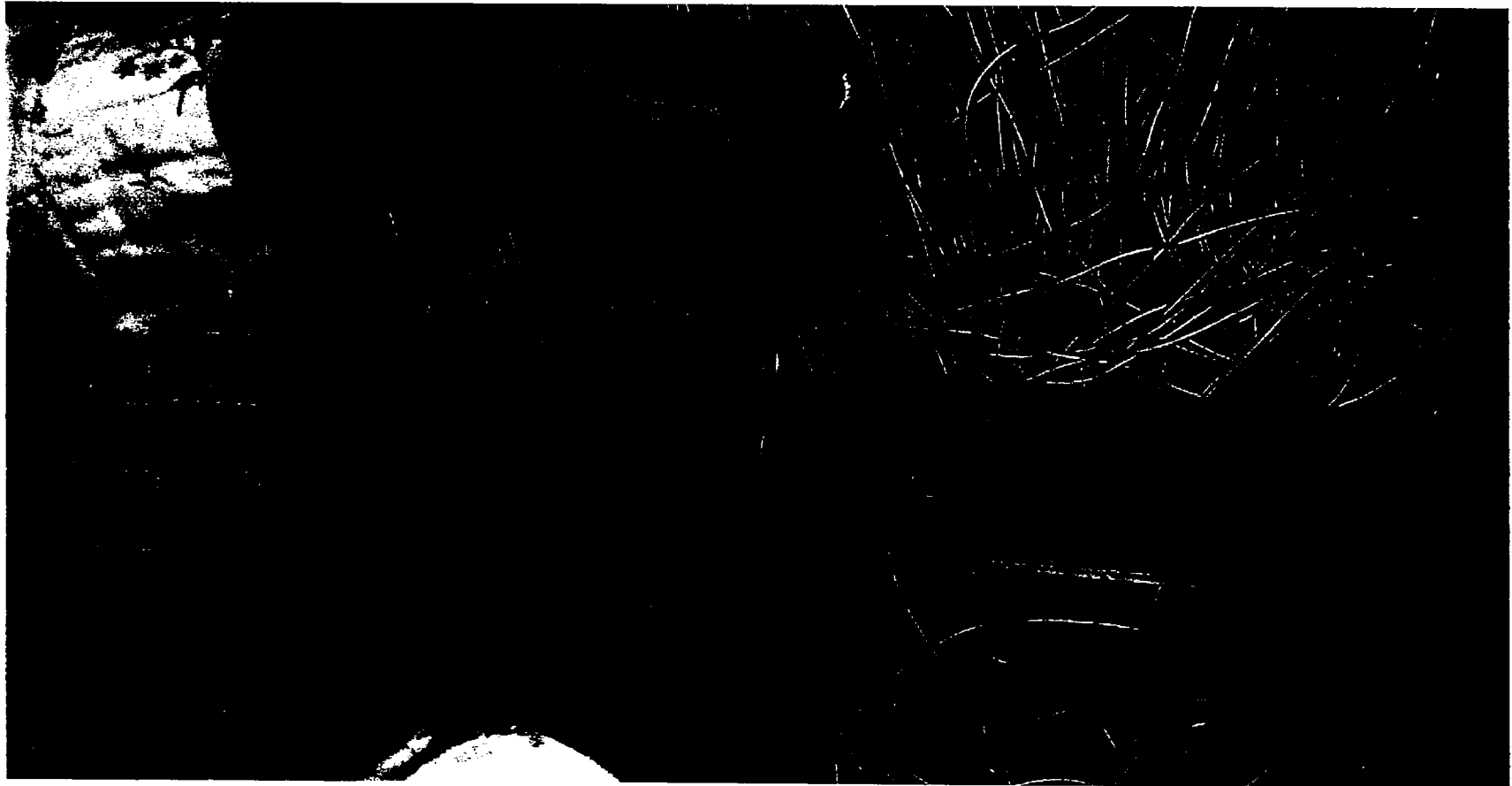

LOOP CUTOVER PROCESS

Step 12: Technician connects new jumper
on frame to tie cables to ALEC equipment.

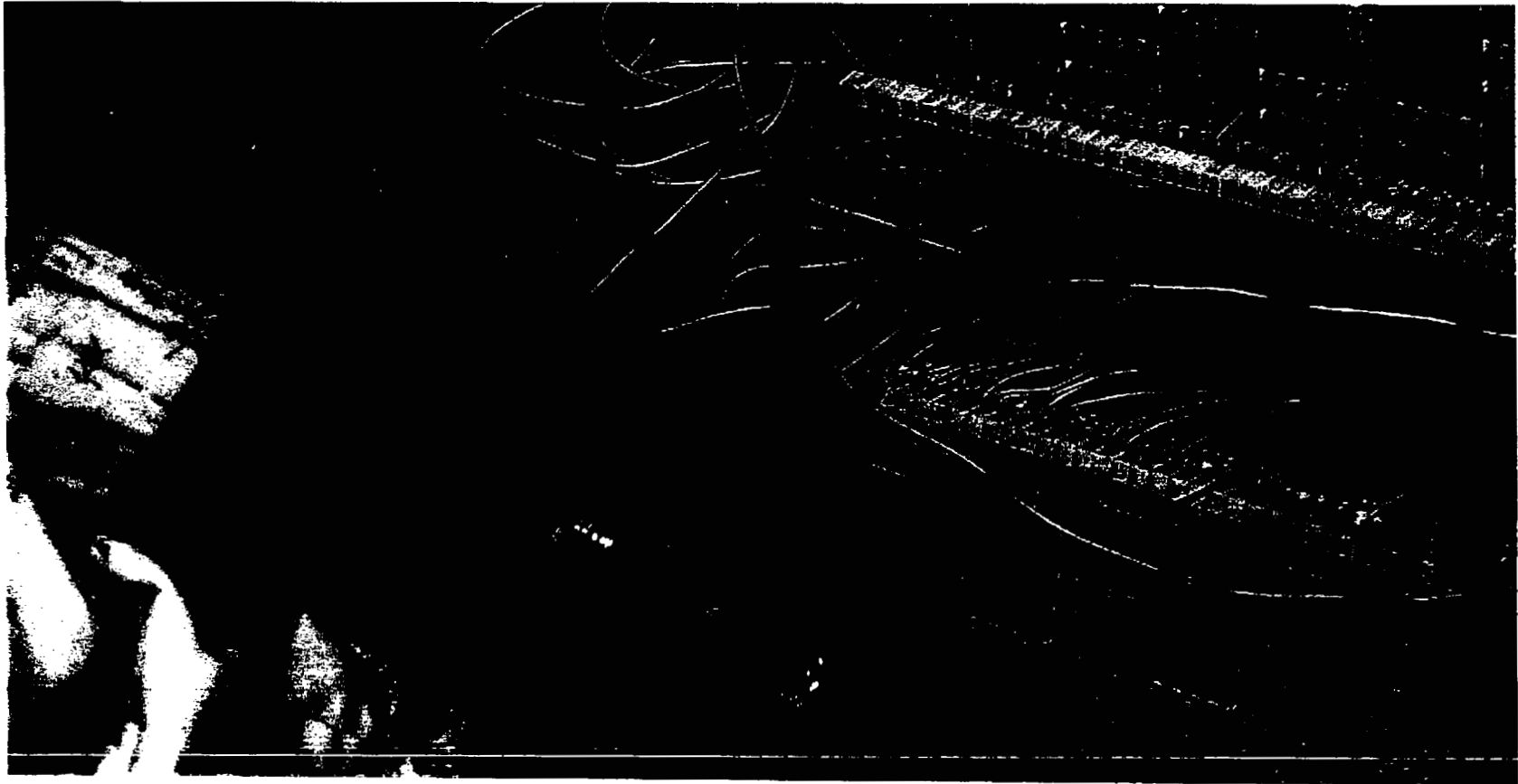

LOOP CUTOVER PROCESS

Step 12: Technician connects new jumper on frame to tie cables to ALEC equipment.

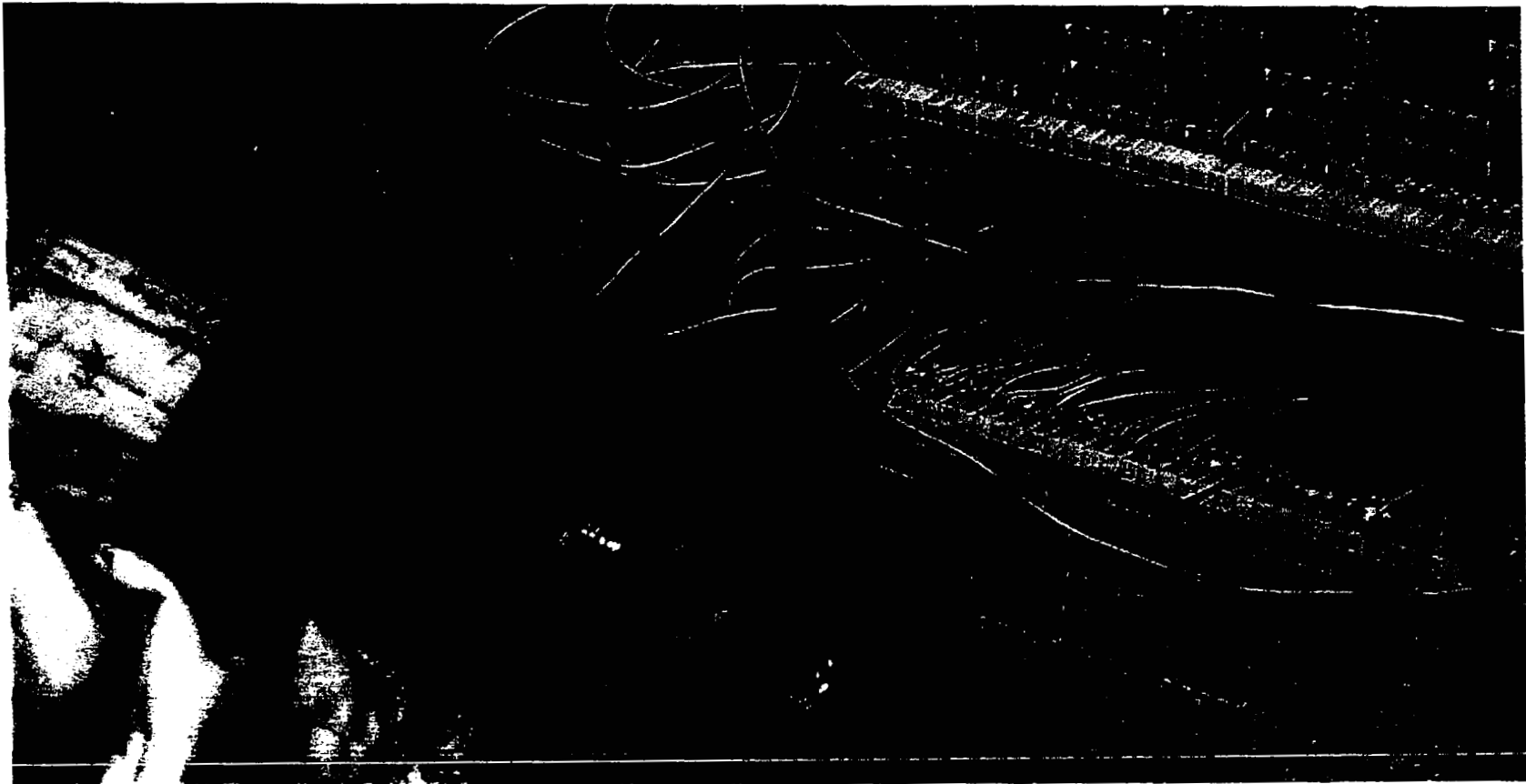

LOOP CUTOVER PROCESS

Step 14: Technician verifies cutover with ALEC, closes order, and notifies the UNE Center.



Coordinated Hot Cut Process

Assumption: Non-Complex, Designed Unbundled Voice Loop, CO Conversion, with LNP

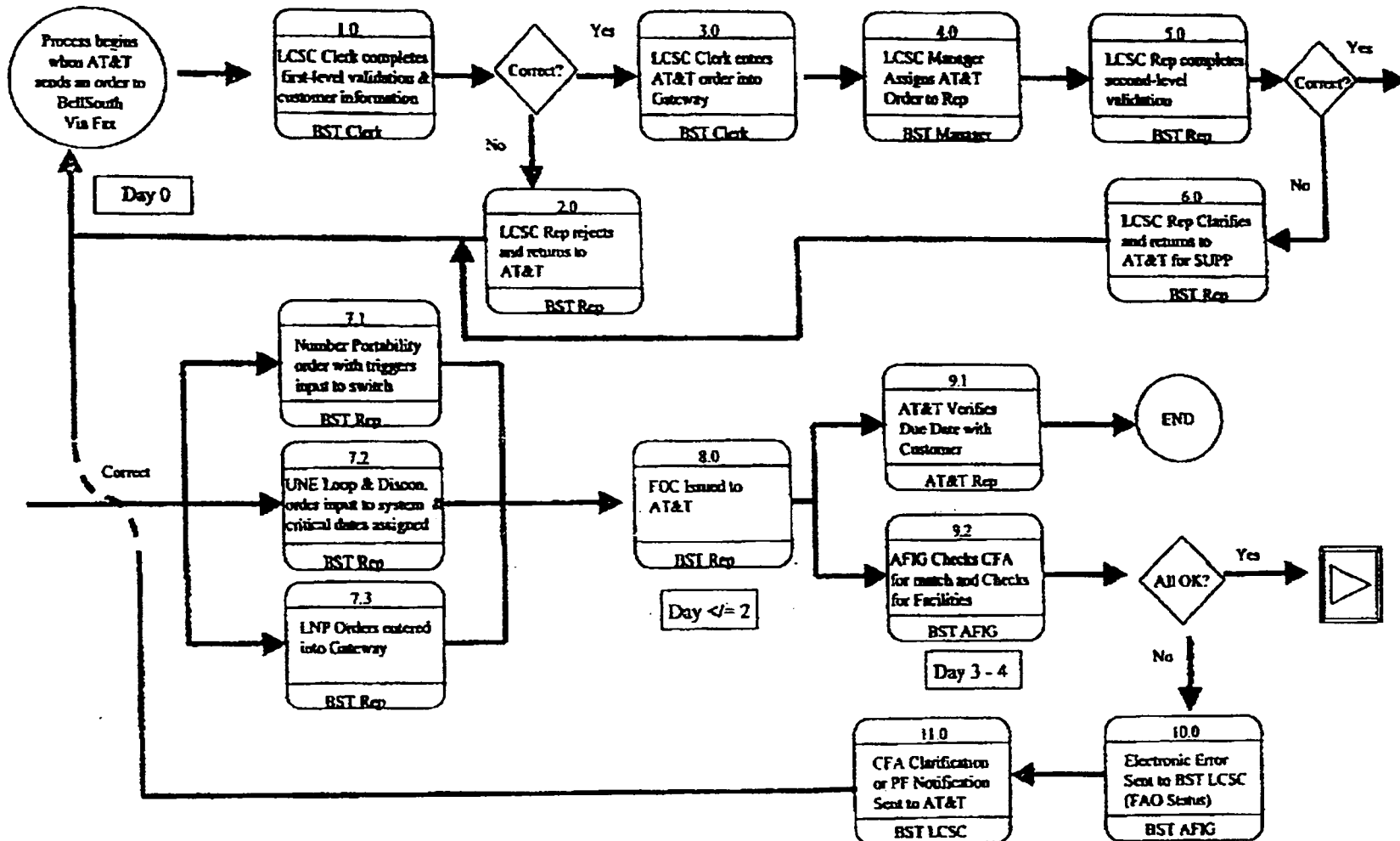

Coordinated Hot Cut Process

Assumption: Non-Complex, Designed Unbundled Voice Loop, CO Conversion, with LNP

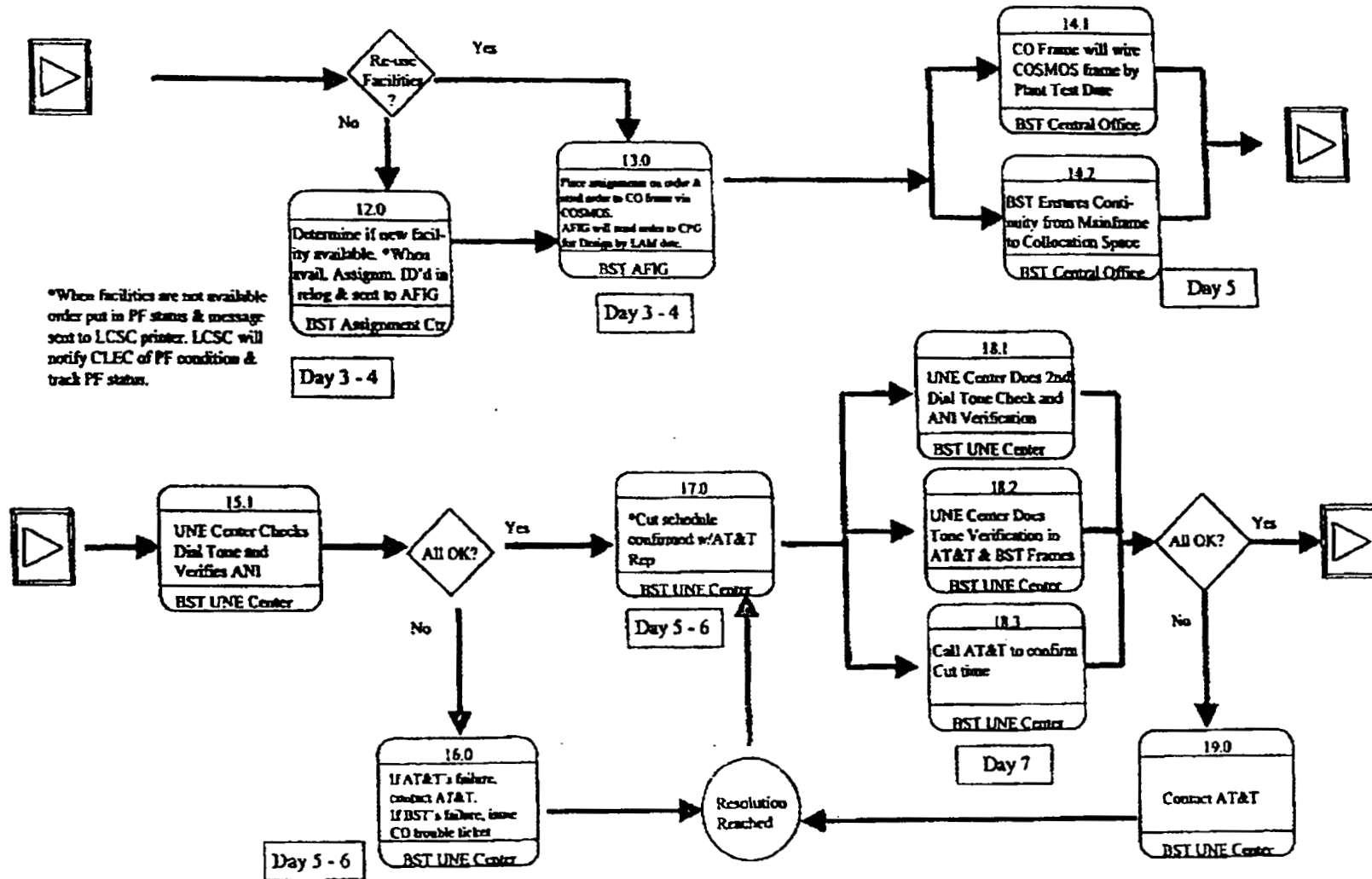

*When facilities are not available order put in PF status & message sent to LCSC printer. LCSC will notify CLEC of PF condition & track PF status.

*Note: UNEC should call AT&T Rep 24 hours before Cut. If call is not made, AT&T will call UNEC.

Issue 2,
 4/18/00

Coordinated Hot Cut Process

Assumption: Non-Complex, Designed Unbundled Voice Loop, CO Conversion, with LNP

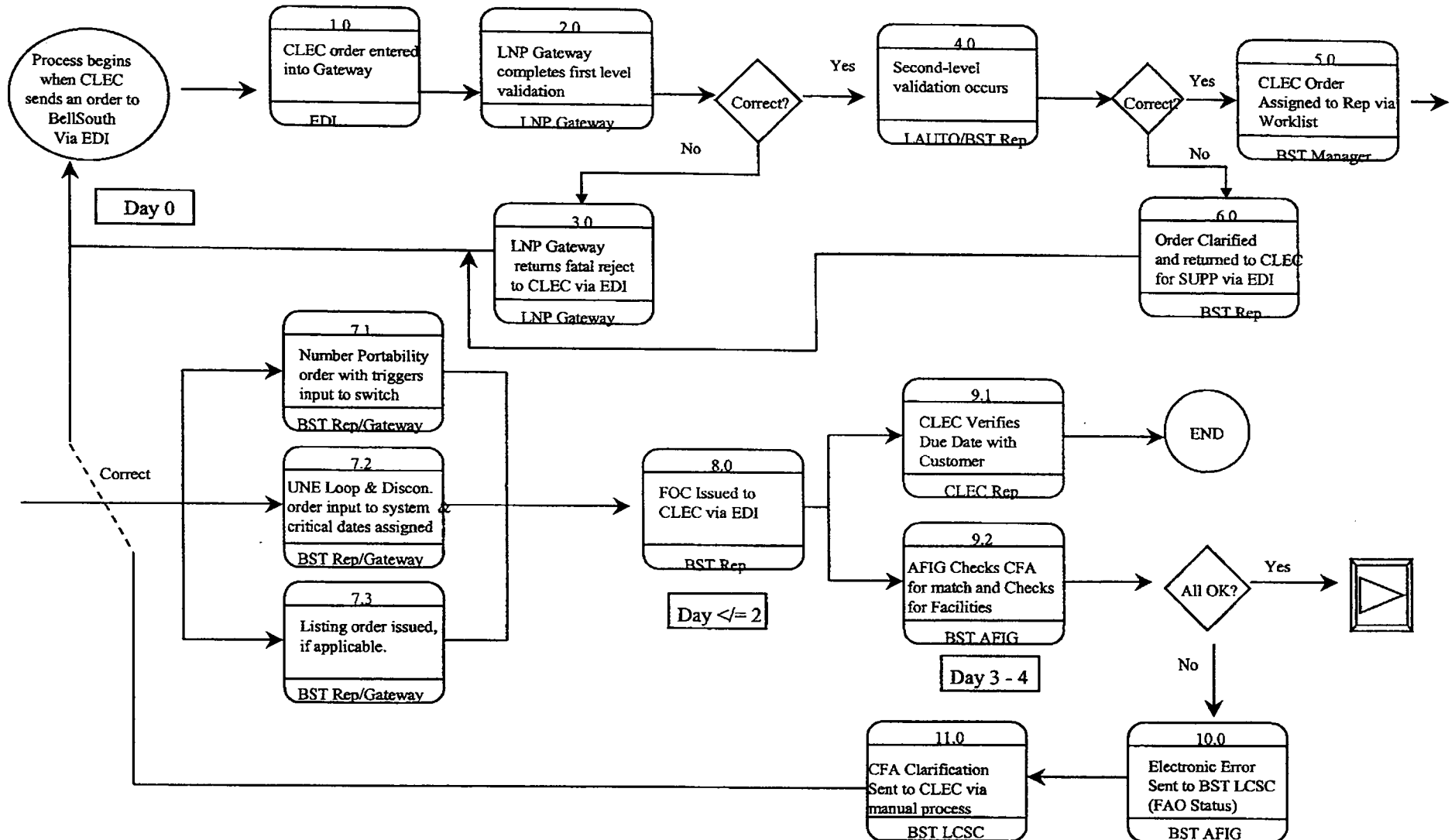

Coordinated Hot Cut Process

Assumption: Non-Complex, Designed Unbundled Voice Loop, CO Conversion, with LNP

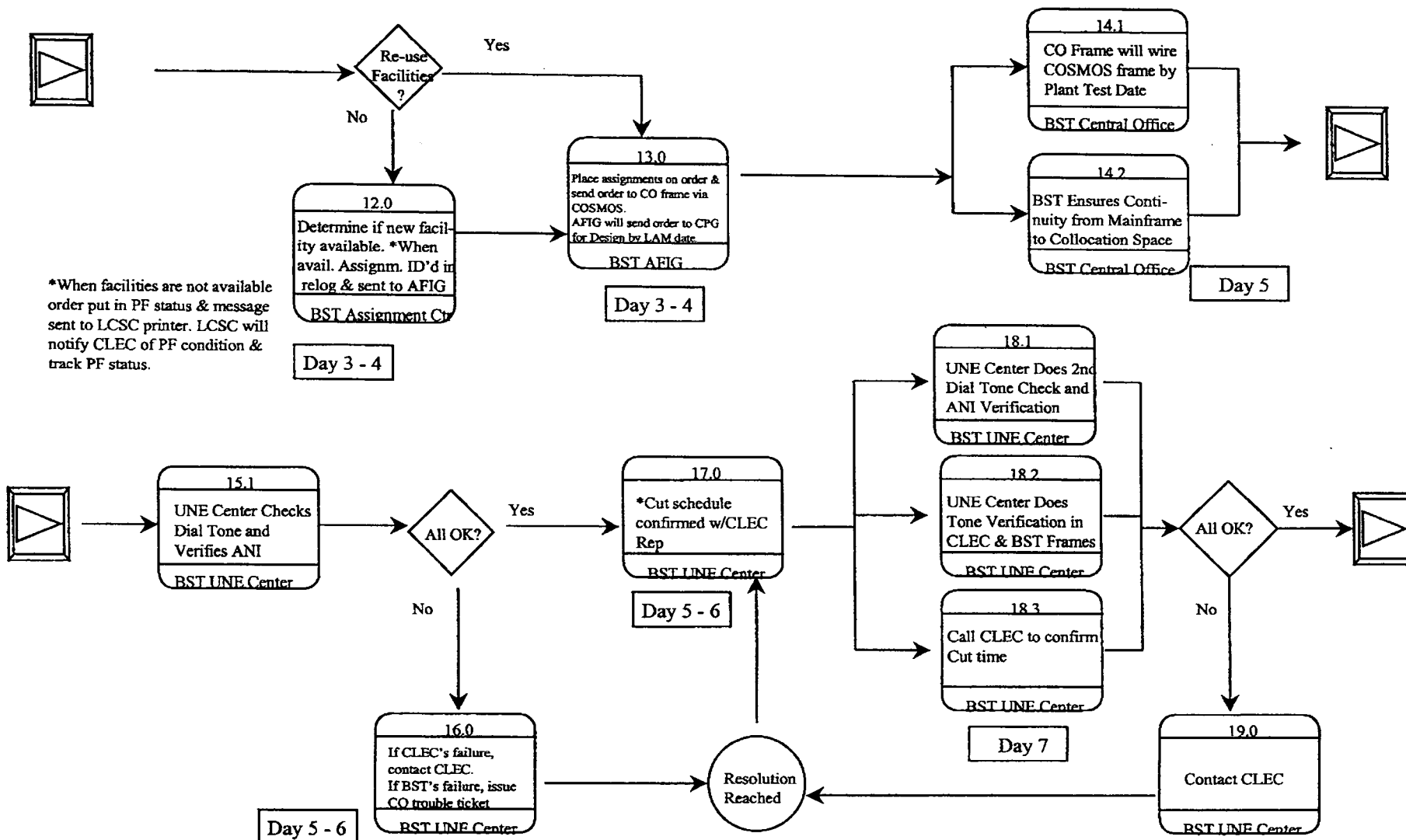

*Note: Within some contracts, UNEC should call CLEC Rep 24 hours before Cut. If call is not made, CLEC will call UNEC.

Coordinated Hot Cut Process

Assumption: Non-Complex, Designed Unbundled Voice Loop, CO Conversion, with LNP

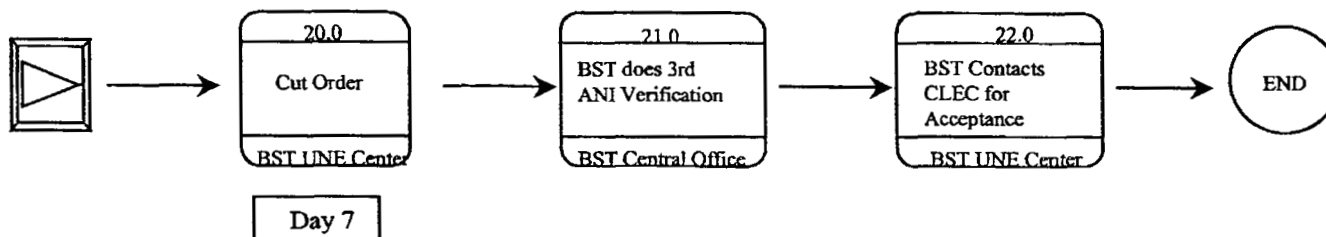

Critical Dates used internally by BellSouth

Service Issue Date

Line Assign Made

Design Verify Assign

Wire Office Toll

Frame Completion Date

Plant Test Date

Due Date

Note: When an order is issued (SID), pseudo order drops to WFA-C to alert UNE Center. Order is screened until designed, then loaded to a UNE technician. The UNE technician will begin testing and verification activity within 24-48 hours prior to the scheduled Due Date.

Issue 2,
 4/18/00

Coordinated Hot Cut Process

Assumption: Non-Complex, Designed Unbundled Voice Loop, CO Conversion, with LNP

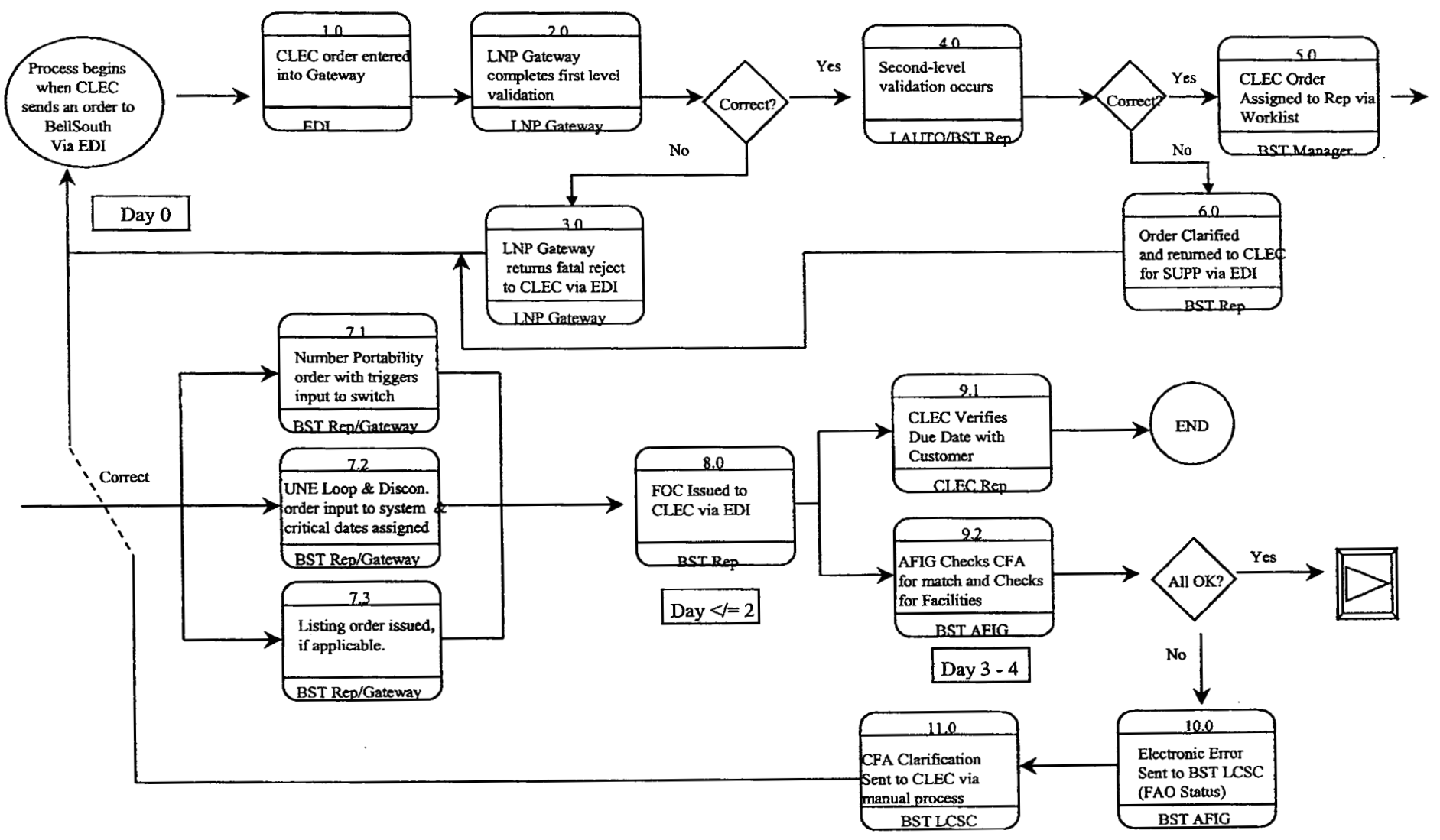

Coordinated Hot Cut Process

Assumption: Non-Complex, Designed Unbundled Voice Loop, CO Conversion, with LNP

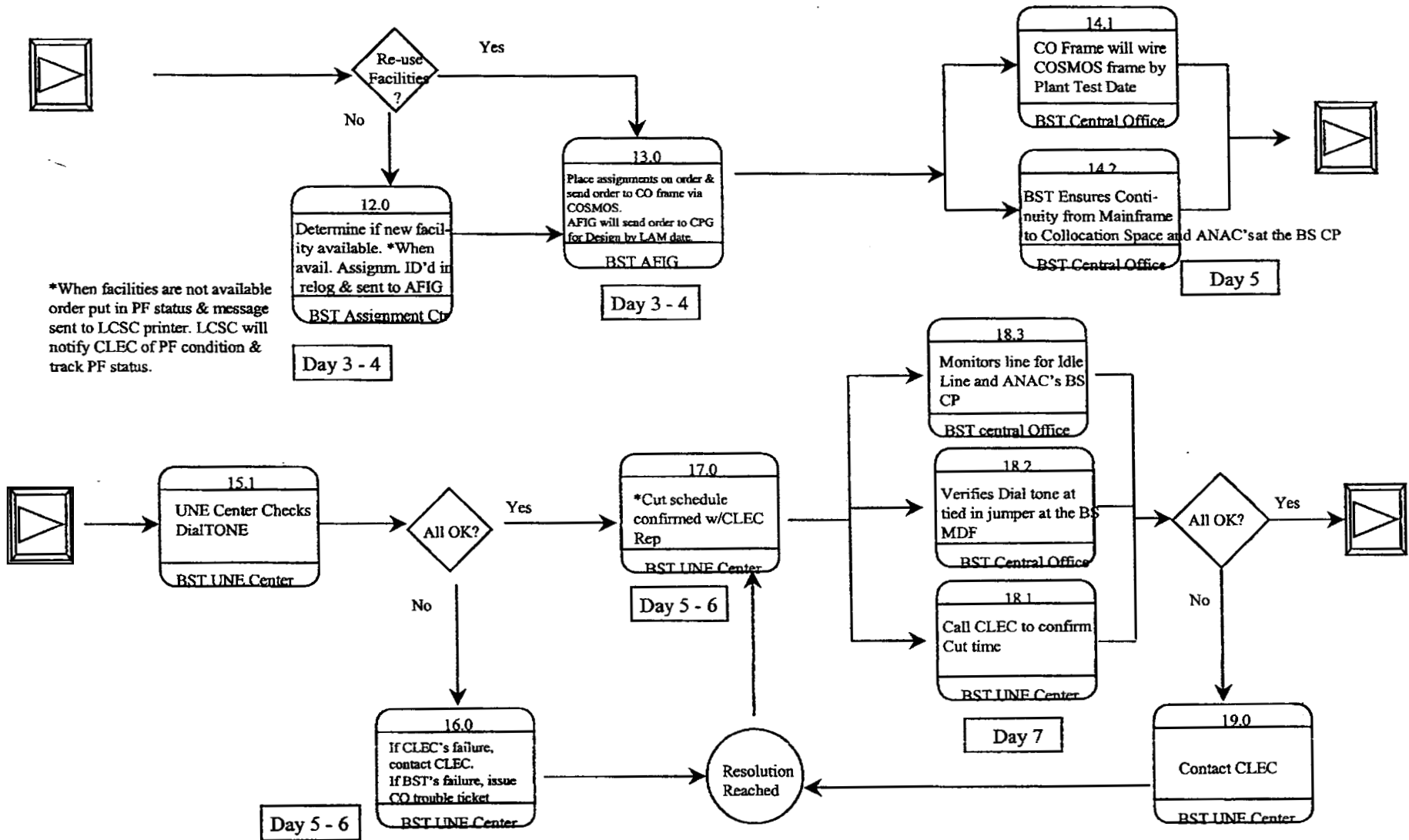

*Note: Within some contracts, UNEC should call CLEC Rep 24 hours before Cut. If call is not made, CLEC will call UNEC.

Coordinated Hot Cut Process

Assumption: Non-Complex, Designed Unbundled Voice Loop, CO Conversion, with LNP

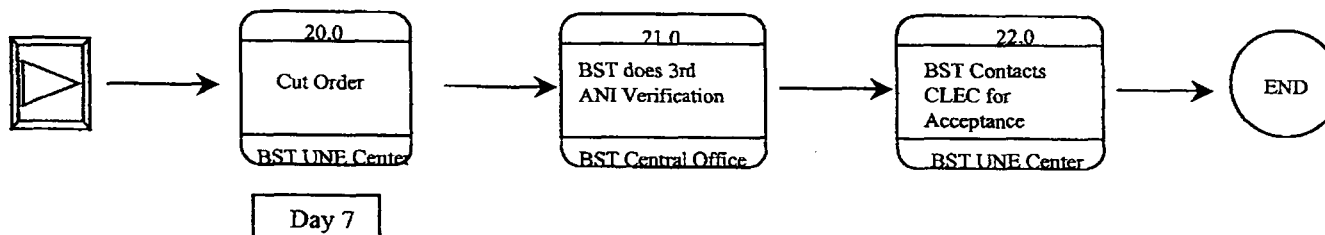

Critical Dates used internally by BellSouth

Service Issue Date
Line Assign Made
Design Verify Assign
Wire Office Toll
Frame Completion Date
Plant Test Date
Due Date

Note: When an order is issued (SID), pseudo order drops to WFA-C to alert UNE Center. Order is screened until designed, then loaded to a UNE technician. The UNE technician will begin testing and verification activity within 24-48 hours prior to the scheduled Due Date.

- 9.0 CENTRAL OFFICE UNBUNDLED LOCAL LOOPS PROVISIONING JOB AID
- 9.1 **SL2 Unbundled Loop Design Circuits**
- 9.2 All designed circuits will be manually coordinated by the UNE Center
2 WFA/DI Tickets Issued
PSA Ticket to provision TIRKS Circuits
LNP or UNE Ticket to provision the COSMOS Circuits
- 9.3 UNE tickets will consist of orders with all facilities in a Spare Pending Connect Status. These orders may be wired, tested, and completed prior to the order Due Date. Presence of CLEC Dial Tone or Signaling is not required. A cross office continuity test must be preformed. The WFA/DI tickets must be completed 100%. The 'Start Date & Time' fields must be populated prior to WFA/DI ticket completion.
- 9.4 LNP tickets consist of orders reusing the BellSouth Cable Pairs (CP). These circuits must be wired (made ready at the BellSouth CP) and a cross office continuity test performed from the CLEC demarcation point (POT) to the tied in jumper at the BellSouth CP on or before WOT date. If this is a voice grade circuit, the BellSouth line should be ANAC'd to insure Database integrity. If the TN that is ANAC'd and the TN in COSMOS do not match, the Central Office (CO) will place this order in A1 jeopardy with a remark noting the actual working TN on that Cable Pair.
- 9.5 PSA ticket with a WOT step should be completed 100%.
- 9.6 LNP ticket should be completed 100%.
- 9.7 UNE Center will issue a SPLAP (work code of NT) ticket notifying CO of cut 48 hours prior to due date. For a non-attended office or outside of normal business hour cuts, the CO technician should notify the Network Manager and complete ticket 100%. The TIRKS engineering is not always available 48 hours prior to due date so the UNE Center will issue the appointment ticket as soon as the engineering is available.
- 9.8 UNE Center will issue a SLPIA ticket and call the CO to cut the circuits.
- 9.9 CO will advise UNE Center to Hold and proceed to cut location (BellSouth CP).
- 9.10 If voice grade circuit, CO will test for CLEC Dial Tone (DT) at tied in jumper.

- 9.11 If No Dial Tone (NDT), CO will go to Demarcation point (POT) and test for CLEC DT. If CLEC DT is not present, CO will remove the bridging clips, wait 2 minutes, and retest on CLEC side. When NDT condition exists from CLEC equipment, CO will advise UNE Center of specific CLEC CP that NDT condition is on. If a multi-line order, no cuts will be made if NDT condition exists on one or more circuits.
- 9.12 If CLEC DT is present at tied in jumper, CO will monitor the BellSouth line. If the line is idle, CO will ANAC the BellSouth TN. When the line is not idle, CO will notify the UNE Center that the conversion can not continue and the UNE Center will direct further activities. If the BellSouth TN does not match the Service Order, CO will locate the correct CP. When CLEC DT is present on the tied in jumper and the BellSouth TN is ANAC'd, CO will advise UNE Center that they are ready to begin the conversion. CO will remove jumper from BellSouth Cable Pair and terminate tied in jumper. CO will ANAC the line and report the CLEC TN to UNE Center. CO will remain on line with UNE Center until CLEC has accepted circuit.
- 9.13 If DDS grade circuit, CO will test for proper Signaling at tied in jumper.
- 9.14 If No Signaling (NS), CO will go to Demarcation point (POT) and test for CLEC Signaling. When NS condition exists from CLEC equipment, CO will advise UNE Center of specific CLEC CP that NS condition is on. If a multi-line order, no cuts will be made if NS condition exists on one or more circuits.
- 9.15 If Signaling is present at tied in jumper, CO will advise UNE Center that they are ready to begin the conversion. CO will remove jumper from BellSouth Cable Pair and terminate tied in jumper. CO will advise UNE Center when all circuits have been cut. CO will remain on line with UNE Center until CLEC has accepted circuit.
- 9.16 When UNE Center advises CO that CLEC accepted circuit, the CO will complete the SLPIA ticket 100%.

NOTE 1: If Unbundled DS1 Loops (Hicap), the WFA/DI tickets will be SPAH for provisioning, HISAP for the appointment ticket, and HISPIA for the cut.

NOTE 2: The industry standard ANAC number is 800-223-1104. If this number does not work contact the UNE Center and have them acquire the CLEC's ANAC number.

10.0 CENTRAL OFFICE UNBUNDLED LOCAL LOOPS PROVISIONING JOB AID

10.1 **SL1 Unbundled Loop Non-Designed Circuits with a Frame Due Time (FDT) of 9:00pm**

- 10.2 Non-designed circuits with a FDT of 9:00pm (Circuit ID of TYNU) will be voice grade circuits and will be manually coordinated by the UNE Center. A single WFA/DI ticket (LNP or UNE) will be issued for the provisioning of each order. The LNP or UNE ticket will contain the COSMOS Work Package Number (WPN).
- 10.3 UNE tickets will consist of orders with all facilities in a Spare Pending Connect Status. These orders may be wired, tested, and completed prior to the order Due Date. Presence of CLEC Dial Tone is not required. If No Dial Tone (NDT) exists Central Office (CO) will perform a cross office continuity test. The WFA/DI ticket must be completed 100%. The 'Start Date & Time' fields must be populated prior to WFA/DI ticket completion.
- 10.4 LNP tickets consist of orders reusing the BellSouth Cable Pairs (CP). These circuits must be wired (made ready at the BellSouth Cable Pair) and a cross office continuity test performed from the CLEC demarcation point (POT) to the tied in jumper at the BellSouth CP before the due date. CO will ANAC the BellSouth line to insure Database integrity. If the TN that is ANAC'd and the TN in COSMOS do not match, the CO will place this order in A1 jeopardy with a remark noting the actual working TN on that Cable Pair.
- 10.5 After successfully wiring and testing, the COSMOS WPN will be placed in ID jeopardy (Hold for Call) and the WFA/DI ticket will be completed 100%. The 'Start Date and Time' fields must be completed.
- 10.6 The Frame Output will be filed in a unique ID Jeopardy folder, bin, file, etc. on the local frame desk.
- 10.7 UNE Center will issue a NDSAP (work code of ND) ticket notifying CO of cut 48 hours prior to due date. For a non-attended office, outside of normal business hour cuts, or if a Time Specific cut, the CO technician will notify his/her Network Manager and complete ticket 100%. Orders are not always assigned 48 hours prior to Due Date so the UNE Center will input the appointment ticket as soon as the Order is available.
- 10.8 UNE Center will call the CO to cut the circuits.

- 10.9 CO will advise UNE Center to hold and proceed by testing for Dial Tone (DT) from the CLEC at the tied in jumper at the BellSouth CP. If multi-line order, DT should be checked on all circuits prior to making any cuts. No circuits are to be cut if No Dial Tone (NDT) condition exists on one or more circuits.
- 10.10 If NDT, CO should proceed to the CLEC Demarcation point (POT) and test for DT. If CLEC DT is not present, CO will remove the bridging clips, wait 2 minutes and retest on CLEC side. If NDT from CLEC equipment, CO will notify UNE Center of problem with specific CLEC CP having NDT condition.
- 10.11 If CLEC DT is present at tied in jumper, CO will monitor the BellSouth line. If the line is idle, CO will ANAC the BellSouth TN. When the line is not idle, CO will notify the UNE Center that the conversion can not continue and the UNE Center will direct further activities. If the BellSouth TN does not match the Service Order, CO will locate the correct CP. When CLEC DT is present on the tied in jumper and the BellSouth TN is ANAC'ed, CO will advise UNE Center that they are ready and to start the conversion. CO will remove jumper from BellSouth Cable Pair and terminate tied in jumper. CO will ANAC the line and report the CLEC TN to UNE Center. CO will remain on line with UNE Center until CLEC has accepted circuit.
- 10.12 CO will remain on the line with the UNE Center until they report acceptance from the CLEC.
- 10.13 CO will create a SONPK ticket in WFA/DI to report conversion time and complete the order directly in COSMOS.

NOTE 1: The industry standard ANAC number is 800-223-1104. If this number does not work contact the UNE Center and have them acquire the CLEC's ANAC number.

11.0 CENTRAL OFFICE UNBUNDLED LOCAL LOOPS PROVISIONING JOB
AID

11.1 **SL1 Unbundled Loop Non-Designed Circuits With A Frame Due Time (FDT) of 3:30pm**

11.2 Non-designed circuits with a FDT of 3:30pm (Circuit ID of TYNU) will be non-coordinated voice grade circuits. Central Office (CO) will cut these circuits anytime on the DUE DATE.

11.3 A single WFA/DI ticket (LNP or UNE) will be issued for the provisioning of each order.

The LNP or UNE ticket will contain the COSMOS Work Package Number (WPN).

11.4 UNE tickets will consist of orders with all facilities in a Spare Pending Connect Status. These orders may be wired, tested, and completed prior to the order Due Date. Presence of CLEC Dial Tone is not required. If No Dial Tone (NDT) exists CO will perform a cross office continuity test. The WFA/DI ticket must be completed 100%. The 'Start Date & Time' fields must be populated prior to WFA/DI ticket completion.

11.5 LNP tickets consist of orders reusing the BellSouth Cable Pairs (CP). These circuits must be wired (made ready at the BellSouth Cable Pair) and a cross office continuity test performed from the CLEC demarcation point (POT) to the tied in jumper at the BellSouth CP before the Due Date. CO will ANAC the BellSouth line to insure Database integrity. If the TN that is ANAC'd and the TN in COSMOS do not match, the CO will place this order in A1 jeopardy with a remark noting the actual working TN on that Cable Pair.

11.6 After successfully wiring and testing, the WFA/DI ticket will be completed at 10%.

11.7 Frame output should be filed by Due Date at the Frame desk.

11.8 The CO will cut the circuit(s) on the Due Date.

11.9 If No Dial Tone (NDT) on the tied in jumper, CO will proceed to the CLEC Demarcation point (POT) and test for DT. If DT is not present, CO will remove the bridging clips wait 2 minutes, and retest on CLEC side. If NDT from CLEC, CO will place the COSMOS WPN in I4 jeopardy, complete the WFA/DI ticket at 20%. On multi-line orders no circuits are to be cut if NDT condition exists on one or more circuits.

- 11.10 The Frame Output will be filed in a unique I4 Jeopardy folder, bin, file, etc., on the local frame desk.
- 11.11 If CLEC DT is present at tied in jumper, CO will monitor the BellSouth line. If the line is idle, CO will ANAC the BellSouth TN. When the line is not idle, CO will monitor the BellSouth line every 5 to 10 minutes until the line is idle. If the BellSouth TN does not match the Service Order, CO will locate the correct CP. When CLEC DT is present on the tied in jumper and the BellSouth TN is ANAC'd, CO will lift off jumper at BellSouth CP and terminate the tied in jumper. CO will complete the WFA/DI ticket 100% as soon as cut is completed. The 'Start Date and Time' fields must be completed prior to WFA/DI ticket completion.

NOTE 1: The industry standard ANAC number is 800-223-1104. If this number does not work contact the UNE Center and have them acquire the CLEC's ANAC number.

Designed 2 Wire Loop and Ground Start - Unbundled Voice Loop UNE Center Procedures

Testing

Pre-Service Testing Requirements for Due Date

Once wiring steps have posted complete in WFA/DI, perform all pretesting that is applicable. It is very important that continuity has been verified from the interface facility of the CLEC to the main frame of the Unbundled Loop. The UNEC should validate via dial tone verification test if test points are available. If test points are not available the UNEC will hand off to the CO for a test assist. The UNEC must TEST, TRACK, and ESCALATE until all pre-work has been completed. The CLEC will be contacted 24 to 48 hours prior to DD to confirm conversion schedule. The UNEC will attempt to handoff an appointment ticket (work-type AP) within 48 hours of the DD, or as soon as possible upon receipt of the engineering WORD document.

Check in WFA/C RO field of the OSSOI screen or behind the RRSO FID of the SOCS order for any other related order activity.

Testing Requirements for Due Date

The UNEC tech will handoff an immediate test assist ticket, Work Type IA, to the C.O. The UNEC will then call the C.O. If the handoff goes to the toll group in the C.O. and the toll group does not do these conversions it is the responsibility of the C.O. Toll Tech to get this handoff to the correct person in the C.O. It is not the responsibility of the UNEC to handoff to the frame. The C.O. Tech will show the work time taken to complete the conversion against this test assist ticket.

The CLEC will be notified on the due date of conversion. If contact attempt is unsuccessful, the conversion will proceed at the appropriate time.

For the existing service on the disconnect order, have the C.O. Tech go to BellSouth Cable Pair, pull BellSouth dial tone and ANAC the cable pair and verify that the existing service on the D order is working to the documented assignments.

- If the existing service is working as documented, continue on to next paragraph.
- If the existing service is not working as assigned, the C.O. Tech will resolve the assignment error. Then redo this workstep.
- If the existing service is in a trouble condition the C.O. Tech will resolve the trouble. Then redo this workstep.

Have the C.O. Tech go to the cut point for Unbundled Loop. Have the C.O. tech check for CLEC dialtone on each of the circuits on the service order. CLEC dialtone must be on all circuits on an order for the conversion to continue. If the CO technician advises the UNEC that the line is in use, the UNEC will contact the CLEC for assistance. At the direction

of the CLEC, the conversion will either be initiated or the order will be placed in an MA status per the UNEC SD/MA policy..

- If dialtone is present at the cut point for each circuit, have C.O. tech begin the conversion. Start the CCSS timer for the conversion, and proceed to the next paragraph.
- If dialtone is not present at the cut point for any one of the circuits, have the C.O. Tech go the the C.O. demarcation point (Collocation Cable and Pair) and test for CLEC dialtone.
 - ◆ If dialtone is present at the demarcation point have the C.O. Technician isolate and clear the wiring trouble in the C.O. Redo this workstep.
 - ◆ If dialtone is not present at the demarcation point, the C.O. Technician will inform the UNEC. The UNEC will inform the CLEC and give the CLEC 15 minutes to correct the problem.
 - If the CLEC can correct the problem in the allotted time, repeat this workstep.
 - If the CLEC cannot correct the problem in the allotted time, the UNEC will call off the conversion and place the order into a MA status according the the UNEC SD/MA policy.

On cutovers that use new facilities, the cut point may be at the F2 facility or at the Network Interface. **It is very important on Network Interface Cut points, that the existing Network Interface is reused.**

Have the Field Work Group (FWG) Tech prior to conversion, go to the cut point pull BellSouth dial tone and ANAC the cable pair and verify that the existing service on the D order is working to the documented assignments.

- If the existing service is working as documented continue to next paragraph.
- If the existing service is not working as assigned, the FWG tech will resolve the assignment error. After the assignment error has been resolved, have the FWG redo this workstep.
- If the existing service is in a trouble condition the FWG tech will resolve the trouble. After the trouble condition has been resolved, redo this workstep.

Have the Field Work Group (FWG) Tech check each circuit on the order for CLEC dialtone. CLEC dialtone must be present on all circuits on the service order to proceed with the conversion.

- If CLEC dialtone is present on all circuits, have the FWG Tech begin the conversion. Start the CCSS timer, and proceed to the next paragraph.
- If CLEC dialtone is not present on all circuits, the UNEC will coordinate the FWG Tech and a C.O. Tech in determining if CLEC dialtone is present at the C.O. demarcation point (CLEC Cable and Pair).
 - ◆ If dialtone is present at the demarcation point, have the C.O. and FWG Techs isolate the wiring trouble and repair. Repeat this work step.
 - ◆ If dialtone is not present at the demarcation point, the C.O. Technician will inform the UNEC. The UNEC will inform the CLEC and give the CLEC 15 minutes to correct the problem.
 - If the CLEC can correct the problem in the allotted time, repeat this work step.

- If the CLEC cannot correct the problem in the allotted time, the UNEC will call off the conversion and place the order into a MA status according to the UNEC SD/MA policy.

Due to contract negotiations the CLECs have the opportunity to specify a time window for the cutover. The negotiated time for conversion must be met. Failure to do so could result in rebating the non-recurring service order charges back to the CLEC based on contract language.

After the cutover is complete have the C.O. Tech/FWG Tech go to the end user side of the cut point. Then use the CLEC ANAC code, to ANAC the UVL. Note the CLEC number and match against the CLEC telephone number associated with the UVL on the cut sheet.

- If the numbers match, continue on to next workstep.
- If the numbers are different, have the C.O. Tech/FWG Tech isolate and clear the trouble. After the trouble has been resolved redo this step.
- If the numbers are different, but no BellSouth trouble can be isolated and cleared, inform the CLEC that they may have a potential translations problem in their switch. There are certain types of legitimate end-user services where the telephone number you call to reach that end-user, and the telephone number you hear when you ANAC the circuit will be different. The CLEC will have to determine if this is the cause of the ANAC mismatch. An example of when this will occur is with terminals within a Multiline Hunt Group (MLHG). Usually the terminals in the MLHG will ANAC the Main Telephone Number assigned to terminal one (1) in the group.

After the CO technician advises the UNEC that the cutover has been completed, the UNEC will stop the CCSS conversion timer and notify the CLEC of the completed conversion

Non-design Unbundled Voice Loops and Non-design Unbundled Sub-Loops UNE Center Procedures

Conversion Coordination

PRESERVICE: For coordinated UVL or USL conversions the UNE Center will contact the CLEC 24/48 hours prior to due date to confirm conversion date and time. Time specific requests by the CLEC is identified on the service order behind the OCSL USOC. The UNE center will hand off an appointment ticket within 48 hours prior to the Due Date, or as soon as possible upon receipt of the assignments on the order. Coordinated non time specific requests will be scheduled at the discretion of the UNE center and CLEC notified. Non coordinated SL1s will not have pre Due Date notification by the UNEC. Prior to the coordinated conversion the UNEC will check COSMOS for an ID jeopardy to ensure the CO is wired. If COMOS does not show the ID jeopardy, the UNEC will call the CO to determine pre-wiring status.

DUE DATE: For coordinated SL1 UVL conversions the UNEC will contact the CO. Handoff for a test assist ticket does not apply on SL1's. The UNEC will have the C.O. Tech access the existing BellSouth Cable and Pair at the cut point. The C.O. Tech will ANAC the BellSouth line to ensure the assignments on the order are correct. The UNEC and C.O. Tech will resolve any discrepancies. The UNEC will then have the C.O. Tech check for CLEC dialtone on all circuits at the cut point. CLEC dialtone must be present on all circuits for the conversion to continue. If the CO technician advises the UNEC that the line is in use, the UNEC will contact the CLEC for assistance. At the direction of the CLEC, the conversion will either be initiated or the order will be placed in an MA status per the UNEC SD/MA policy.

- CLEC will be notified on due date of conversion. If contact is unsuccessful, conversion will proceed at appropriate time.
- If CLEC dialtone is present, continue to next paragraph.
- If dialtone is not present at the cut point for any one of the circuits, have the C.O. Tech go the C.O. demarcation point (Collocation Cable and Pair) and test for CLEC dialtone.
 - ◆ If dialtone is present at the demarcation point have the C.O. Technician isolate and clear the wiring trouble in the C.O. Redo this work step.
 - ◆ If dialtone is not present at the demarcation point, the C.O. Technician will inform the UNEC. The UNEC will inform the CLEC and give the CLEC 15 minutes to correct the problem.
 - If the CLEC can correct the problem in the allotted time, repeat this work step.
 - If the CLEC cannot correct the problem in the allotted time, the UNEC will call off the conversion and place the order into a MA status according to the UNEC SD/MA policy.

When CLEC dialtone has been verified the cutwill begin. The UNEC will start the Coordinated Cut Scheduling System (CCSS) conversion timer as appropriate. After the C.O. Tech advises the UNEC the cutover has been completed the UNEC will stop the CCSS conversion timer. Have the C.O. Tech go to the end user side of the cut point. Then use the

CLEC ANAC code, to ANAC the UVL. Note the CLEC number and match against the CLEC telephone number associated with the UVL on the cut sheet.

- If the numbers match, continue on to next work step.
- If the numbers are different, have the C.O. Tech isolate and clear the trouble. After the trouble has been resolved redo this step.
- If the numbers are different, but no BellSouth trouble can be isolated and cleared, inform the CLEC that they may have a potential translations problem in their switch. There are certain types of legitimate end-user services where the telephone number you call to reach that end-user, and the telephone number you hear when you ANAC the circuit will be different. The CLEC will have to determine if this is the cause of the ANAC mismatch. An example of when this will occur is with terminals within a Multiline Hunt Group (MLHG). Usually the terminals in the MLHG will ANAC the Main Telephone Number assigned to terminal one (1) in the group.

Notify the CLEC of the completed conversion.

Upon CLEC acceptance the associated service orders will be completed in WFA and SOCS. For coordinated USL conversions, the UNEC will wait for the outside technician to get to the crossbox or equipment room. The UNEC should have the FWG Tech ANAC the BellSouth pairs prior to conversion to verify assignments. CLEC dialtone will also be verified prior to the conversion. The CLEC will then be advised that the cut will begin. The UNEC will document the conversion time in CCSS as appropriate. Upon CLEC acceptance the associated service orders will be completed in WFA and SOCS.

DUE DATE: SL1 UVL non coordinated conversion due date activities for the UNE Center require only post conversion notification to the CLEC and tracking for network order completion. The UNEC will be notified of order completion by EnDI and the UNEC will place a notification call to the CLEC. The UNEC will follow up on any order pending completion as of 2:30 PM on the due date. The UNE Center will escalate all pending orders to the WMC in order to meet the service due date. The UNE Center will also be the CLEC point of contact for any SL1 non coordinated order provisioning issue. The UNE Center will complete or validate completion of the service order after CLEC notification.



BellSouth Interconnection Services 770 492 7550
 Suite 700 Fax 770 492 4117
 1960 West Exchange Place
 Tucker, Georgia 30084

AT&T Regional Account Team

February 28, 2000

Mr. Anthony Colbert
 AT&T
 1200 Peachtree Street N.E.
 12th Floor
 Atlanta, GA. 30309



Dear Anthony:

This letter is to confirm the completion of BellSouth's portion of the AT&T Local Service (ALS)/BellSouth database alignment project for ALS assignments and to share with ALS the results of BellSouth's investigation.

As you will recall, this project was initiated at the end of May 1999, with BellSouth's Account Team providing ALS with files of working assignments. ALS used these files to create exception lists that identified the assignments that ALS records indicated as spare when BellSouth's records showed them as working. ALS was unable to cross reference a circuit ID, making it necessary for the Account Team to research each assignment on the exception lists in order to provide ALS with the Purchase Order Number (PON) that established each circuit. ALS then examined the updated lists and gave BellSouth instructions as to the disposition of each circuit and assignment. When applicable, the Local Carrier Service Center (LCSC) then used these instructions to issue disconnect orders for the assignments that ALS verified as spare. This activity was completed in late September 1999.

On January 18, 2000, I received confirmation that approximately 50 assignments that could not be cleared with a disconnect order have all been changed to indicate spare assignments. As of this date, all of the assignments that ALS authorized BellSouth to disconnect have been either disconnected or the status has been changed to spare in BellSouth's databases.

The breakdown of the information in the initial exception lists provided to the Account Team by ALS is as follows:

Total number of assignments in project	3442	
Number of assignments in alignment per AT&T	883	26% of total
Number of assignments in conflict per AT&T:	2559	74% of total

The Account Team researched and provided available PON information to ALS on the assignments shown working in BellSouth's database. A summary of the findings is detailed in the following table:

Number of assignments requiring status change by BellSouth, per AT&T	129	5% of total
--	-----	-------------

BellSouth believes that this small percentage of discrepancies does not indicate any database integrity problem on the part of BellSouth.

The Account Team, LCSC operations and database support personnel performed extensive investigation in an effort to isolate the source of these relatively few discrepancies. This group was unable to determine the exact cause of all of the discrepancies. Many of them may be attributed to ALS' belief that a supplement to cancel an order had not been properly handled by BellSouth, however, a search of the fax server data did not indicate that a supplement had ever been received. Some of the discrepancies were actually update timing differences between the ALS and BellSouth databases rather than assignment status conflicts.

The last group of discrepancies involves approximately 50 assignments that could not be resolved by issuing disconnect orders in the LCSC. The circuit IDs shown working on these assignments were not being billed by BellSouth and therefore could not be corrected with a disconnect order. These assignment discrepancies appear to be related to ALS canceling the PON after some or all of the physical work had been performed. Sufficient data (because order and provisioning systems regularly purge) did not exist to draw any definite conclusions from this commonality. The number of assignments affected in this manner total only 2% of the 2559 database discrepancies. The Account Team conducted extensive investigation to identify the proper resources and determine what actions needed to be taken to complete the cleanup effort for these 50. As stated in Paragraph 3 of this letter, these assignments have been changed to spare in BellSouth's databases.

It is BellSouth's position that given the small number of assignment discrepancies this project revealed in BellSouth's assignment database, an action plan to address BellSouth's assignment database integrity is not warranted at this time. Please call me on 770-492-7557 if you have any questions.

Sincerely,

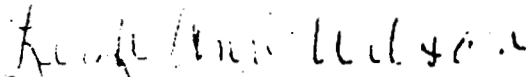

Leigh Ann Wilson
AT&T Regional Account Team

Cc: Jan Burriss
Denise Berger
Sandra C. Jones