

AUSLEY MCMULLEN

ATTORNEYS AND COUNSELORS AT LAW

123 SOUTH CALHOUN STREET
P.O. BOX 391 (ZIP 32302)
TALLAHASSEE, FLORIDA 32301
(850) 224-9115 FAX (850) 222-7560

October 27, 2015

VIA: ELECTRONIC FILING

Ms. Carlotta S. Stauffer
Commission Clerk
Florida Public Service Commission
2540 Shumard Oak Boulevard
Tallahassee, Florida 32399-0850

Re: Docket No. 150213-EI – Tampa Electric Company's Petition for Approval of
Advanced Meter Program Agreement

Dear Ms. Stauffer:

Attached for filing in the above docket is Tampa Electric Company's Responses to Staff's
First Data Request (Nos. 1-16) dated October 13, 2015.

Thank you for your assistance in connection with this matter.

Sincerely,

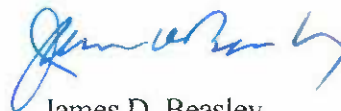

James D. Beasley

JDB/pp
Attachment

cc: Sevini Guffey

**TAMPA ELECTRIC COMPANY
DOCKET NO: 150213-EI
STAFF'S 1st DATA REQUEST
REQUEST NO. 1
PAGE: 1 OF 1
FILED: OCTOBER 27, 2015**

1. Please list all the annual expenses to TECO associated with offering the advanced meter program. List each expense and associated dollar amount separately.

A. The annual expenses for the AMP program are in part dependent on how many customers elect to participate. Assuming approximately 100 customers elect to participate the annual expenses are expected to be approximately \$20,000. The expenses by item are:

Nighthawk ¹ communications and webhosting cost	\$ 5,400
Includes: \$3.00 per meter for cellular com.	
Annual hosting and support fee:	\$12,100
Configuration of the web portal:	\$ 2,000
 Total:	 \$19,500

¹ See response to Data Request No. 13 in this set, showing the utilization of Nighthawk cellular (through Verizon) communication equipment in concert with GE meter

**TAMPA ELECTRIC COMPANY
DOCKET NO: 150213-EI
STAFF'S 1st DATA REQUEST
REQUEST NO. 2
PAGE: 1 OF 1
FILED: OCTOBER 27, 2015**

- 2.** Please explain how will TECO recover the costs of this program listed in the question above during a) the initial three year term, and b) after the initial term if agreements continue.
 - A.** All costs associated with this program are considered base rate costs, so no cost recovery will be requested through any clause.

**TAMPA ELECTRIC COMPANY
DOCKET NO: 150213-EI
STAFF'S 1ST DATA REQUEST
REQUEST NO. 3
PAGE: 1 OF 1
FILED: OCTOBER 27, 2015**

- 3.** Paragraph 3 of the proposed agreement provides for an initial three-year term of the agreement. Please discuss what would happen if a customer wished to terminate the agreement prior to the completion of the initial term. In addition, if there is any penalty for terminating the agreement prior to the completion of the term, please state the amount of the penalty.

- A.** If a customer asked to terminate the agreement, TECO would remove the generation meter at no cost or penalty to the customer.

**TAMPA ELECTRIC COMPANY
DOCKET NO: 150213-EI
STAFF'S 1ST DATA REQUEST
REQUEST NO. 4
PAGE: 1 OF 1
FILED: OCTOBER 27, 2015**

- 4.** After the completion of the initial term of the agreement, please state how much notice TECO or the customer must provide to terminate the agreement.
 - A.** No notice for termination is required. If the customer would like to exit the program during the initial term then TECO will remove the meter as soon as it can be scheduled for both the customer and TECO. When the initial term has ended the customer will be given at least 30 day notice before the agreement is terminated.

**TAMPA ELECTRIC COMPANY
DOCKET NO: 150213-EI
STAFF'S 1ST DATA REQUEST
REQUEST NO. 5
PAGE: 1 OF 1
FILED: OCTOBER 27, 2015**

- 5.** Please state whether the agreement could be transferred to another customer if, e.g., the customer that initially executes the agreement sells his/her residence.
 - A.** If a participating customer sells his or her residence while the agreement is in effect, Tampa Electric will offer the new owner the opportunity to participate in the program and if the new owner desires to do so will require the new owner to sign a new agreement.

**TAMPA ELECTRIC COMPANY
DOCKET NO: 150213-EI
STAFF'S 1ST DATA REQUEST
REQUEST NO. 6
PAGE: 1 OF 1
FILED: OCTOBER 27, 2015**

- 6.** Please state whether renters who are the customers of record and who rent the premises that have pre-existing customer-owned photovoltaic systems installed by the property owner would be eligible for the advanced meter program agreement.
 - A.** Only the owner of the property can elect to participate in the program and can sign the agreement. Under the agreement, the owner will be granted access to the secure website and the data made available through it. No billing data goes to the website, only generator output data. The owner may make access to the website available to the renter/customer of record on their own. If a renter who is a customer of record inquires about the program with Tampa Electric, they will be directed to engage with their property owner to secure the property owner's interest to participate in the program and the property owner's request from Tampa Electric to participate. Tampa Electric believes all the email addresses it has on file are with property owners only and not renters.

**TAMPA ELECTRIC COMPANY
DOCKET NO: 150213-EI
STAFF'S 1ST DATA REQUEST
REQUEST NO. 7
PAGE: 1 OF 1
FILED: OCTOBER 27, 2015**

- 7.** After the initial three year term, please state whether there would be a charge to a customer to continue with the program. If yes, please state the amount.

- A.** At this time there is no expectation that any separate charge to the customer will be sought after the initial three year term. Should there be any change in that approach to this service Tampa Electric would seek Public Service Commission approval for any such separate charge prior to imposing one on AMP customers.

**TAMPA ELECTRIC COMPANY
DOCKET NO: 150213-EI
STAFF'S 1st DATA REQUEST
REQUEST NO. 8
PAGE: 1 OF 1
FILED: OCTOBER 27, 2015**

- 8.** Please state how many of TECO's residential customers own solar photovoltaic systems.
 - A.** Through September 30, 2015, Tampa Electric has 637 residential customers that own grid-tied solar photovoltaic systems.

**TAMPA ELECTRIC COMPANY
DOCKET NO: 150213-EI
STAFF'S 1ST DATA REQUEST
REQUEST NO. 9
PAGE: 1 OF 1
FILED: OCTOBER 27, 2015**

- 9.** Please explain why this agreement is limited only to residential customers and not to commercial customers as well.
 - A.** The program will only reach out to residential customers initially in order to keep this pilot program manageable. The pilot is limited to residential customers until the system is tested and operational knowledge has been gained. The program could be expanded to commercial solar customers at a later date.

**TAMPA ELECTRIC COMPANY
DOCKET NO: 150213-EI
STAFF'S 1ST DATA REQUEST
REQUEST NO. 10
PAGE: 1 OF 6
FILED: OCTOBER 27, 2015**

- 10.** Paragraph 3 of TECO's petition states the company "...will solicit participation by existing Tampa Electric residential customers who own photovoltaic systems."
- a. Please state the number of customers TECO expects to sign up under the tariff.
 - b. Please state whether TECO has already developed, or is in the process of developing, any materials to market the tariff to customers. If so, please provide copies of any materials already developed and/or drafts of materials currently being developed.
 - c. Please describe the benefits customers will receive as part of participation in the tariff.
- A.**
- a. Tampa Electric will initially solicit all residential customers who own solar photovoltaic generators via e-mail. About 500 of the 637 customers with solar photovoltaic generators have email addresses on file with the company and it is anticipated that about 20 percent of these customers will choose to participate (around 100). Tampa Electric is only seeking a portion of the eligible customers to participate in the program, although Tampa Electric has no plans to limit the number of participants. Tampa Electric believes this solicitation strategy will secure a sufficient participation level for the purposes of this pilot.
 - b. The e-mail will direct these customers to a secure landing page with information about the program. Customers can request an appointment on this web site if they are interested in the program. The e-mail and landing pages are still under development, however the current draft email and landing page are attached. Any residential customer who has solar photovoltaic generators but who does not receive the email because the company does not have their email address, but who learns of the program and requests to participate, will be included in the program.
 - c. The benefits to participating customers include the following:
 - An advanced utility-grade electric meter will be installed on participating customers' homes to measure the output of their solar photovoltaic generating system.

**TAMPA ELECTRIC COMPANY
DOCKET NO: 150213-EI
STAFF'S 1st DATA REQUEST
REQUEST NO. 10
PAGE: 2 OF 6
FILED: OCTOBER 27, 2015**

- Participating customers will have access to a secure Web portal that lets them monitor the output of their system.
- Customers can utilize the reliable, utility-grade output data to ensure that their system is performing as it should.

DRAFT

Track your PV generation with free advanced meter from Tampa Electric

As a valued net meter customer, we'd like to invite you to participate in our new Advanced Metering Program (AMP) pilot at no cost to you.

The new **Advanced Metering Program (AMP)** will let you track the electricity generated by your photovoltaic (PV) system through a secure Web portal - all for Free! Your current utility service net meter only tracks the energy delivered and received through your utility meter. AMP participants will get a new, utility-grade meter that will track the energy generated by your PV system! You will also receive 24/7 access to a secure Web portal to monitor the data recorded by this new AMP meter to ensure your system is performing as it should.

To participate, click the button below to request an appointment with a Tampa Electric representative. After conducting an evaluation, the technician will discuss the best location for the new AMP meter and answer any questions you may have about this voluntary program. You are under no obligation to participate if you request an appointment.

Get started... [Request an appointment!](#) <<Link to Landing Page>>

Don't miss this opportunity! Please respond by **XXXXXX XX, 2016**, to take advantage of this offer. You will be added to a waiting list should you miss this initial offering.

If you have any questions, please feel free to contact us at Solar@TampaElectric.com.

Thank you for being a Tampa Electric customer. We look forward to installing this free AMP meter for you.



Search site with Google... Go

Select Language SHRE f t e

You've been selected to participate in a FREE pilot program.



As a valued *net meter* customer, you have been selected to participate in our new **Advanced Metering Program (AMP)** pilot that will let you track the electricity generated by your photovoltaic (PV) system through a secure Web portal - all for Free!

Here's what you get:

- An advanced utility-grade electric meter that will measure the output of your PV system.
- Access to a secure Web portal that lets you monitor output of your PV system.
- Reliable, utility-grade output data that will help ensure your PV system is performing as it should.

To participate, click the button below to schedule an appointment with a Tampa Electric meter technician. After conducting an evaluation, the technician will determine where to install the new advanced meter and answer any questions you may have about the pilot program.

[Schedule Your Appointment Now!](#)

[Download Program FAQs](#)

TECO Energy's [privacy policy](#) and [legal notices](#).
Copyright © 2015 [TECO Energy](#). All rights reserved.

Find us       



Search site with Google...

Select Language

[Home](#) [Residential](#) [Business](#) [Company](#) [Connect to Us](#)



HOME / RESIDENTIAL / ADVANCED METERING PROGRAM (AMP) PILOT

Advanced Metering Program (AMP) Pilot

Advanced Metering Program (AMP) Pilot

[Back to Previous Page](#)

Please complete this form to participate in the Advanced Metering Program (AMP) pilot. Once we receive your information, we will contact you to schedule a pre-inspection at your home. Please know that by submitting this form, you are under no obligation to participate in the program.

* indicates required field

* Name:

* Street Address

* City / State / Zip:

* E-mail address:

* Verify e-mail address:

* Primary Phone:

Alternate Phone:

* Best time to call:
 Morning (between 8am and noon)
 Afternoon (between noon and 5pm)

Comments: (500 characters left)

Spam reminder

Please be sure to check your email spam or junk folder if you don't see an email notification from us.



TIP: Add our email address to your email contact list. This will help to ensure our emails sent to you will be delivered to your inbox.

IMPORTANT NOTICE ABOUT YOUR REQUEST: If you do not receive a confirmation e-mail after you have submitted this form, you may have provided an incorrect e-mail address or your spam filter, a system for blocking unwanted e-mail messages, may be switched on.

<p>Residential</p> <ul style="list-style-type: none"> Residential Highlights Pay Your Bill Your Account Payment Support Power Outages Programs Storms & Safety Save Energy Report a Concern 	<p>Business</p> <ul style="list-style-type: none"> Business Highlights Pay Your Bill Your Account Payment Support Programs Save Energy Construction 	<p>Company</p> <ul style="list-style-type: none"> Company Highlights About Us Our Power System Media Center Business Resources Careers Environment Renewable Energy Manatees Electric Vehicles Community 	<p>Connect to Us</p> <ul style="list-style-type: none"> Contact Us e-News Update Sign Up The Power Blog Customer Service Q & A
---	---	--	---

Tampa Electric is a [TECO Energy](#) company | [Peoples Gas](#) | [New Mexico Gas Company](#)

TECO Energy's [privacy policy](#) and [legal notices](#).
 Copyright © 2015 [TECO Energy](#). All rights reserved.

Find us



Advanced Meter Program Pilot

Frequently asked questions

Q: Will Tampa Electric remove the advanced meter if I ask?

A: Yes, if you decide to stop participating in the pilot program, Tampa Electric will remove the advanced meter that measures the output of your photovoltaic (PV) system, at no cost to you.

Q: Will participating in the pilot have any impact on my monthly electric statement?

A: No, you will see no change to your electric statement. Your electric statement will continue to display the amount of electricity your PV system delivers to Tampa Electric's grid.

Q: Why is Tampa Electric conducting this pilot and how will the company use the data?

A: The pilot will assist Tampa Electric in its ongoing efforts to research various PV system designs that are being installed across West Central Florida. The data will also assist Tampa Electric with planning and forecasting.

Q: Will the advanced meter replace my existing net meter?

A: The advanced meter is a second meter that will be installed near your existing disconnect switch. However, as a participant in the pilot, Tampa Electric will upgrade your existing net meter with one that can be read remotely.

Q: Will Tampa Electric need to access the new advanced meter each month?

A: No, Tampa Electric will collect the meter data remotely. However, the meter must be available for Tampa Electric access as with any other electric meter.

Q: How long will the pilot last? Will I still have access to the Web portal once it ends?

A: The pilot will last about three years or once Tampa Electric receives enough data to complete its research. Ongoing access to the portal will be determined once the pilot ends.

Q: Are there any costs or fees to participate in the pilot?

A: Participation in the pilot is free. Tampa Electric will install the advanced meter and provide access to the secure Web portal at no cost to you.

Q: Will I be required to sign an agreement to participate in the pilot program?

A: Yes. For your convenience, please view this [sample agreement](#) that our meter technician will ask you to sign on the day we perform a pre-inspection at your home.

**TAMPA ELECTRIC COMPANY
DOCKET NO: 150213-EI
STAFF'S 1ST DATA REQUEST
REQUEST NO. 11
PAGE: 1 OF 2
FILED: OCTOBER 27, 2015**

11. Please describe in detail the process TECO will utilize to install the advanced meter behind the customer's meter.
 - a. Please provide any diagrams depicting the installation of the new meter.
 - b. Please state whether TECO elected to install disconnect switches on all Tier 1 net metering installations.
 - c. Please state whether TECO believes the advanced meter would be subject to the FPSC meter testing rules.

- A.
 - a. Please see attached diagram.
 - b. Yes. Tampa Electric elected to require all Tier 1 net metering installations to include disconnect switches at or near the meter. Reimbursement was provided by the company for the installation of these switches.
 - c. For the pilot project the meters will not be subject to FPSC meter testing rules because the meters are for informational purposes only and are not used for billing. However, the meters being installed will meet FPSC and ANSI meter standards.

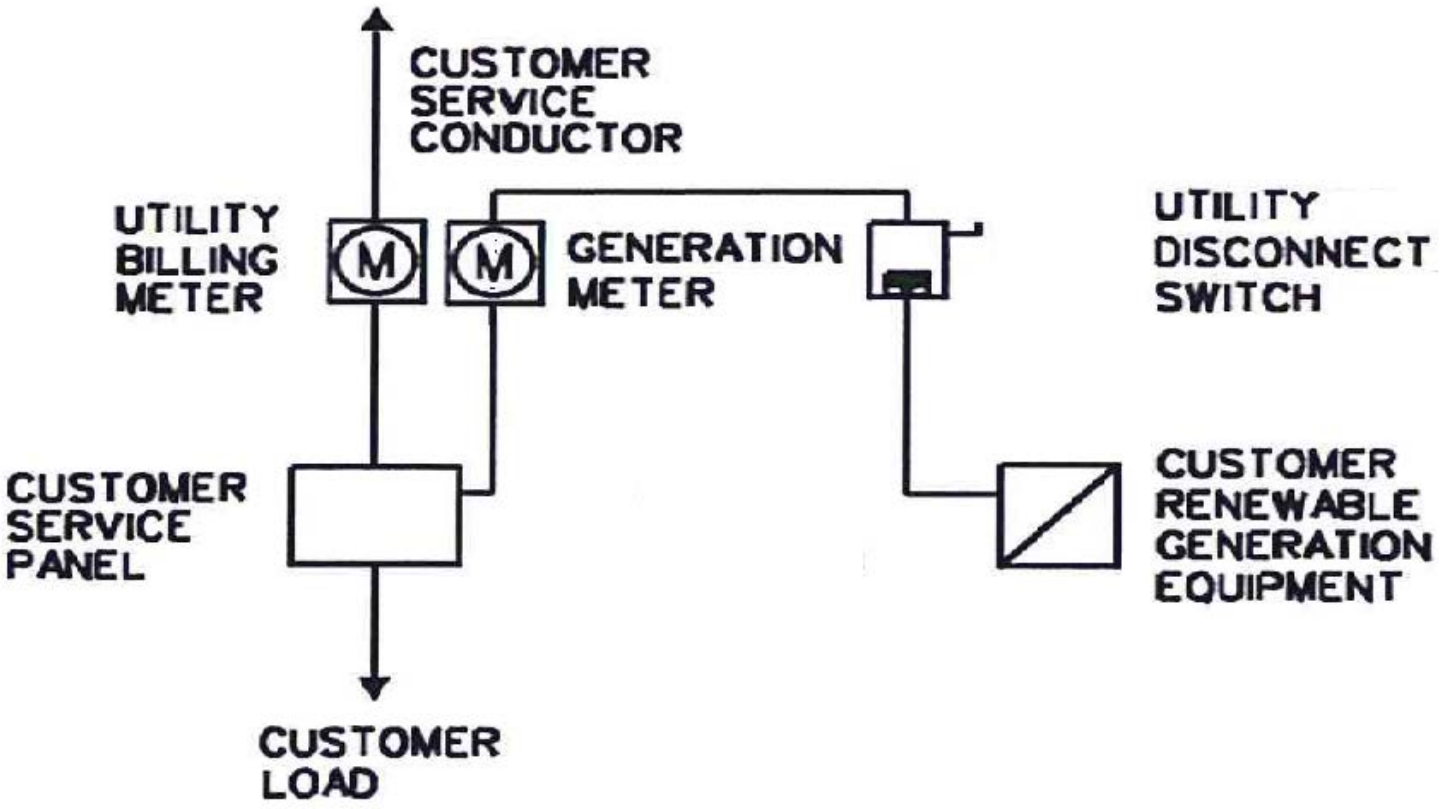

**TAMPA ELECTRIC COMPANY
DOCKET NO: 150213-EI
STAFF'S 1ST DATA REQUEST
REQUEST NO. 12
PAGE: 1 OF 1
FILED: OCTOBER 27, 2015**

- 12.** Please describe the difference between an “advanced meter” and an advanced infrastructure meter.
 - A.** An advanced infrastructure meter has two way communications from the utility to the premise. An advanced meter does not.

**TAMPA ELECTRIC COMPANY
DOCKET NO: 150213-EI
STAFF'S 1ST DATA REQUEST
REQUEST NO. 13
PAGE: 1 OF 10
FILED: OCTOBER 27, 2015**

- 13.** For the meters being installed as part of this tariff, please indicate the manufacturer, model, and method of communication for each meter. Please also provide a copy of the manufacture's technical specifications.
 - A.** The solar photovoltaic generation meter which is covered by the proposed tariff is provided by Nighthawk. This meter will communicate with the meter that is being installed to replace the existing house meter sending it the meter data. Then the new house meter will communicate via a Nighthawk cellular device to the company. The attached document provides the technical specifications for the meter and the cellular device.



General Electric® I-210 Series Meter With Nighthawk RDG960 Cellular

Connected by: **verizon**wireless



The RDG960 is a wireless remote two-way residential disconnect / AMI meter that provides solutions for:

1. High Turnover residences: Dormitories, Apartments
2. Inaccessible Meters: fences, hostile people and animals
3. Slow-pay / No-pay / Pre-Pay customers
4. Fill-in for dead spots in existing AMR/AMI systems

Instantly adds key smart grid features - Provides unparalleled payback

Solution Features:

- Web based remote read / disconnect / reconnect
- Outage notification alert with mapping
- Reports and data downloads in PDF or CSV formats
- Demand Response program to shed load
- Future-Proofed: Over-the-air firmware upgrades
- Ability to Re-Zero the meter (Coming soon)
- 30/30 Mode (Coming soon)

Solution Benefits:

- Saves money on expensive truck rolls
- Keeps utility personnel out of harms way
- Lowers risk and liability for accidents
- Improves service response with alerts
- System-wide coverage with no infrastructure allows incremental meter rollouts
- Industry standard integration with billing systems
- Add additional features Over-the-air
- Reduces damaging socket wear and risk of fire

Utility WebConnect™

Nighthawk's Utility WebConnect is an award winning Cloud-based Web application running 24/7, and connected to multiple communications gateways. Even when utility personnel are not online, Utility WebConnect is collecting meter readings, issuing automated batch commands to devices and alerting utility personnel of alarming events via cellular text messages or email.



GE
Digital Energy

Residential Electrical Metering



Advanced ANSI metering for the Smart Grid

For more than 100 years GE has provided utilities with robust and high quality metering solutions. GE's I-210 product line continues that tradition, bringing innovative and flexible technology solutions that cover all your metering needs from basic electronic energy-only meters to highly-flexible smart metering solutions that provide advanced functionality to meet the evolving Smart Grid system needs.

GE's family of meters go beyond meeting your complex business challenges. The advanced, powerful and easy-to-use meters give you an extra edge in the energy business. You can look forward to real-time instrumentation, power quality monitoring and easy access to critical information. All these add up to give you higher productivity, improved efficiency and reduced energy costs.

Key Benefits

- Reliable and accurate cash register for utilities
- AMR/AMI Plug-n-Play functionality
- Multiple communication technologies tied to AMI systems provide reliable data in a timely manner
- Smart metering functions such as Time of Use demand metering and service switch capabilities
- Demand side management through pre-payment and demand limiting features
- Advanced functions such as reactive measurement and, IEEE reliability indices measurement
- Robust meter security and standards compliance

ANSI Single Phase Meters



I-210+c Full featured, Smart Grid enabled metering

This is GE's flagship residential meter product, offering demand, load profile, TOU, service switch, and a full complement of communication options.



I-210+ Value packed Smart Grid functions

World class accuracy and reliability in a solid-state kWh meter platform package. Available with a service switch, as well as a wide array of communications options.

Communications

- Broad AMI/AMR Plug-n-Play options - RF Mesh, Power line carrier, Cellular, etc
- Allows interchangeability of AMR/AMI Plug-n-Play options
- Supports connectivity and integration with 3rd party communications solutions providers

Smart Configuration

- Ability to customize advanced metering options to suit customer's needs
- Configure load profile, time of use and demand metering capabilities
- Versatile programming Softswitches allowing the selection of advanced functionality such as power quality measurement and reactive power measurement
- Service Switch option improves operational efficiency and addresses issues such as demand side management, remote repayment systems, and controlled outage restoration

Reliability

- Robust revenue-grade watt-hour and demand meters
- Based on GE's cutting edge technology providing typical 0.2% accuracy, and reliability
- Enable utilities with tools to lower operational cost and provide accurate metering solutions



imagination at work

Residential Electrical Metering

Reliable Metering

In this dynamic time of regulatory scrutiny and customer engagement, you can be assured of the product and the company behind the product. We have ANSI and ISO certified labs to ensure that our product design and manufacturing processes yield a robust product every time.

Our testing procedures go well beyond the ANSI and IEC requirements for which we design to, including some of the most aggressive internal standards in the market place today. We now have included world-class Radio Frequency (RF) communications expertise to ensure that our meter products are hardened to withstand even the harshest of RF environments without sacrificing the quality or integrity of the metrology or the communications technology.

Accurate & Dependable

Typically measured at +/- 0.2%, the GE I-210 family of meters provides best-in-class capabilities for accuracy. Combined with the low starting watts, the utility can have confidence in the metered value and measured electricity usage.

Integrity of Supply

Having a partner that can provide assurance in supply is critical when a utility begins a mass deployment of meters. GE's process focus and rigor around supply chain excellence minimizes the risk to the utility, giving them confidence to manage installation crews and provide accurate scheduling to customers.

Broad Communications Support

The I-210 family has been designed to allow for the interchangeability of AMR/AMI modules and cover the broadest range of possible AMI communication technologies including RF Mesh, Cellular, Power Line and Ethernet. Modules can be added at the GE factory, after the fact, or replaced with another compatible module if the meter is redeployed.

Billing & Smart Applications

Traditional billing continues to be a vital component of today's solid state meters, but they are also now a vital part of your grid operation. We've leveraged the strength and knowledge of GE Digital Energy around distribution automation, volt-var control, demand optimization, and distributed generation to develop a line of metering products that are designed to integrate and provide the critical information needed to optimize all of these grid operation solutions. As GE continues to build on its Smart Grid solutions, you can count on GE Digital Energy and our new metering products to include innovative and unique capabilities you never thought possible.

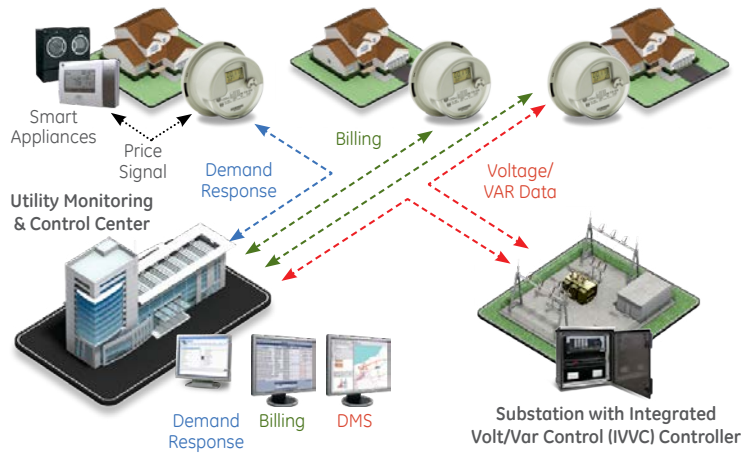

Leading the way on integrated appliances for demand response

One of the most compelling benefits of the Smart Grid is the promise of delivering demand management or load control. Utilities will save energy, lower costs, and defer additional transmission and generation expenses with the ability to shave peak load, shape load and curtail load to mitigate grid events. Additionally, consumers will be able to conserve energy and shift energy use to benefit from time of use or time based rate structures. Various studies have shown that these actions can generate customer savings from 5% to 15% of their monthly electricity use.

GE, through our Digital Energy and Appliance businesses, is continuing to work on integrated solutions for electricity metering and smart appliances in the home. This is an exciting time for our business as we pioneer a new generation of electricity smart meters and smart appliances that work seamlessly together to deliver energy savings never thought possible.



Residential Electrical Metering

Full featured, Smart Grid Meter

I-210+c

Smart Grid enabled, consumer friendly metering

GE's most advanced residential electricity metering product line, the I-210+c, delivers Smart Grid capability for today and the future. Derived from our industry leading commercial and industrial product line, the kV2c, the I-210+c benefits from our advanced metrology capability and lessons learned from over 10 years of solid state metering design. All the way down to the advanced microprocessor, the I-210+c contains much of the advanced polyphase functionality that GE has been known for. We have also added capability that makes the I-210+c the referenced residential product line in the industry.

Capability

Designed for today's dynamic rate structures, the I-210+c provides capability for demand, load profile, and TOU recording, along with a number of other power quality and demand response related functions. Configurable to support various metering quantities, this meter supports delivered (+), received (-), and net metering for distributed generation.

Advanced Functionality

With the addition of the fully rated 200 amp service switch, the meter is capable of pre-payment metering without all the historical cost associated with card readers or other legacy pre-payment technology. Load limiting and emergency conservation modes set this meter apart when working in conjunction with a demand response program. Having the capability to be remotely configured, as well as being firmware upgradeable, this product serves today's needs, as well as tomorrow's evolving requirements.

Communications

Designed to specifically accommodate the communications technology required to support a Smart Grid, the I-210+c has the same electrical and mechanical interface as our I-210+ platform, making communications interchangeable and interoperable between these two residential metering platforms.

AMR/AMI Plug and Play Communications

Multiple communication options on the I-210+c allows greater customer choice. Ideally optimized for RF Mesh, PLC, 3G/4G point-to-point communication technologies, the I-210+c can cover a wide variety of communication scenarios.



Features & Benefits

- Customize advanced metering options through SoftSwitches
- AMR/AMI Plug-n-Play designed to accommodate:
 - Radio Frequency Mesh (RF Mesh)
 - Radio Frequency Point-to-Multipoint
 - Cellular communications
 - Ethernet
- Advanced functionality such as:
 - time-of-use, insensitive demand, load profile recording, event logging, voltage sag/swell recording
- Typical accuracy: within +/- 0.2%
- Service Switch to improve operational efficiency and address issues such as:
 - Demand side management
 - Remote prepayment systems
 - Controlled outage restoration
- Low starting watts; capture energy consumption at levels typically not registered by electromechanical meters
- Low burden, which minimizes utility system losses
- Patented tamper algorithm to detect tamper-by-meter inversion
- Meets or exceeds ANSI C12.1, C12.10, C12.20, C37.90.1

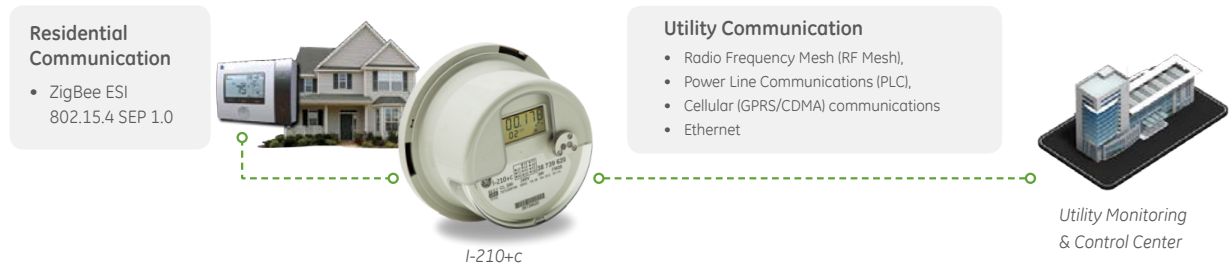

Residential Electrical Metering

Value packed, Smart Grid Meter

I-210+

Load Management

The I-210+ is one of the most popular single phase meters among US utilities for residential metering installations. Equipped with a fully-rated 200A service switch, this meter platform is ideal to provide basic load management functionality.



Reliability

The I-210+ has enjoyed tremendous success in the marketplace for smart meters, with over 10 million units shipped since 2009. This product is the industry benchmark for quality and reliability, having passed both internal and external validation tests for billing accuracy. At GE, we have an unprecedented testing and validation process to ensure that our products are robust and exceed the industry standard ANSI requirements.

We have substantial expertise in wireless communications and the testing that is required to ensure that our meters perform flawlessly, even in the harshest of radio frequency (RF) environments.

Communications

The I-210+ has the same electrical and mechanical interface as our I-210+c platform, designed to specifically accommodate Smart Grid communications technology, making communications interchangeable and interoperable between these two residential metering platforms. Multiple RF Mesh and PLC communication technologies are supported with a newly updated power supply.

Features & Benefits

- AMR/AMI Plug and Play designed to accommodate: RF Mesh, RF Point-to-Multipoint, PLC, Ethernet
- Typical accuracy: within +/-0.2%
- Service Switch to improve efficiency and address:
 - demand side management
 - remote prepayment systems
 - controlled outage restoration
- Low starting watts; capture energy consumption at levels typically not registered by electromechanical meters
- Low burden, which minimizes utility system losses
- Meet or exceeds ANSI C12.1, C12.10, C12.20, C37.90.1

Factory Integrated Communication Options for I-210+ and I-210+c Meters

AMI TECHNOLOGIES	TYPE	I-210+	I-210+C
Aclara UMT-R	PLC	X	
Grid IQ P2MP	RF P2MP	X	X
Itron 54ESS ERT, 55ESS ERT, 56ESS ERT	1-way RF AMR	X	
Itron 57ESS ERT	1-way RF AMR		X
Itron Cellular EVDO & HSPA	Cellular Network		X
Silver Springs Networks NIC 310	RF Mesh	X	
Silver Springs Networks NIC 410	RF Mesh		X
Silver Springs Networks MicroAP	Cellular & RF Mesh		X
Trilliant SecureMesh	RF Mesh	X	X

Residential Electrical Metering

Full featured, Secure Metering Software

MeterMate

GE's innovative MeterMate™ software suite enables meter administrators to easily configure and manage GE meters. Each software component in the MeterMate suite is optimized to address the different aspects of a meter's lifecycle. MeterMate program creation software enables the user to effortlessly configure the meter's basic and advanced functionality, ranging from creating a simple demand program and setting up the meter display to configuring the meter's I/O and alerts. With MeterMate reading and programming software, a user can read, program and perform real-time instrumentation and power quality monitoring on a meter, via a variety of different communication methods such as local OPTOCOM, remote telephone, RS-232/485 and IP communications.

The suite also provides the MeterMate Batch Control, MeterMate Load Profile (MMLp) and MeterMate XTR utilities. MeterMate Batch Control enables the user to automate remote meter reading. MeterMate Load Profile (MMLp) provides analysis of load profile data and MeterMate XTR supports the export of meter data to the MV-90 HHF format.



Features & Benefits

- One software suite to configure and read from the GE portfolio of meters: kV family, I-210 family and SGM3xxx family
- Supports the ANSI C12.19 communication protocol
- Multiple methods to communicate with meters: USB & RS232 OPTOCOM, RS485, Modem
- Modular configuration workflow that enable the reuse of frequently used configuration settings and measurements
- Various reports to display information for meter management, auditing, billing and monitoring power quality
- Command line interface and batch-control enabling automated and scheduled meter operations
- Configurable role-based access control security

With GE meters, your business case just got a whole lot better

At GE, we've leveraged our expertise to ensure you get the most out of your investment in GE products and solutions. The capability available in the GE Smart Meter's provide for data that can be used to optimize a number of utility operational systems outside of traditional billing. These integrated solutions include:

- Outage events and alarms integrated into PowerOn™, GE's Outage Management Solution
- Voltage and Var data, provided in real-time, to enhance distribution automation solutions for Conservation Voltage or Integrated Volt/Var Coordination
- Integration with GE's GridIQ™ Demand Optimization Solution for coordinated load control and demand response for surgical implementation of load shedding and load deferral

The strength of metering products come from our broad knowledge of electrical utilities and their operational systems. We will continue to provide metering products that build on this knowledge and provide differentiated value for both the utilities and the consumer.

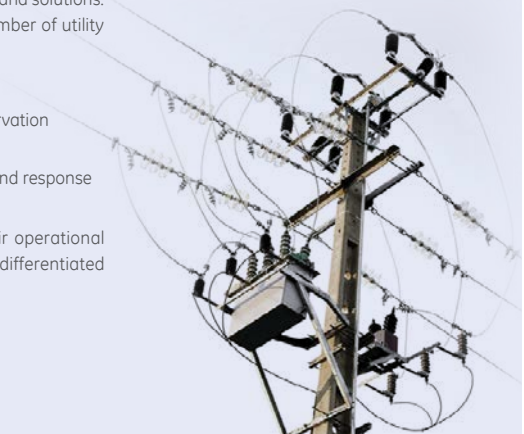

Residential Electrical Metering

Residential Meter Selector

	Product Characteristics	I-210+ Basic Energy	I-120+c																																										
1	Meter Functionality	<ul style="list-style-type: none"> Real Energy Consumption Management 	<ul style="list-style-type: none"> Real Energy Consumption Management Reactive Energy Consumption Measurement Apparent Energy Consumption Measurement Voltage Measurement (Min, Avg, Max) Sag/Swell Measurement Outage Count and Duration 																																										
2	ANSI Models	<table border="1"> <thead> <tr> <th>Form</th> <th>Class</th> <th>Volts</th> </tr> </thead> <tbody> <tr> <td>1S</td> <td>100</td> <td>120 & 240</td> </tr> <tr> <td>2S</td> <td>200 & 320</td> <td>240</td> </tr> <tr> <td>3S & 3CS</td> <td>20</td> <td>120 & 240</td> </tr> <tr> <td>4S</td> <td>20</td> <td>240</td> </tr> <tr> <td>12S</td> <td>200 & 320</td> <td>120 & 240</td> </tr> <tr> <td>25S</td> <td>200 & 320</td> <td>120 & 240</td> </tr> </tbody> </table>	Form	Class	Volts	1S	100	120 & 240	2S	200 & 320	240	3S & 3CS	20	120 & 240	4S	20	240	12S	200 & 320	120 & 240	25S	200 & 320	120 & 240	<table border="1"> <thead> <tr> <th>Form</th> <th>Class</th> <th>Volts</th> </tr> </thead> <tbody> <tr> <td>1S</td> <td>100</td> <td>120 & 240</td> </tr> <tr> <td>2S</td> <td>200 & 320</td> <td>240</td> </tr> <tr> <td>3S & 3CS</td> <td>20</td> <td>120 & 240</td> </tr> <tr> <td>4S</td> <td>20</td> <td>240</td> </tr> <tr> <td>12S</td> <td>200 & 320</td> <td>120 & 240</td> </tr> <tr> <td>25S</td> <td>200 & 320</td> <td>120 & 240</td> </tr> </tbody> </table>	Form	Class	Volts	1S	100	120 & 240	2S	200 & 320	240	3S & 3CS	20	120 & 240	4S	20	240	12S	200 & 320	120 & 240	25S	200 & 320	120 & 240
Form	Class	Volts																																											
1S	100	120 & 240																																											
2S	200 & 320	240																																											
3S & 3CS	20	120 & 240																																											
4S	20	240																																											
12S	200 & 320	120 & 240																																											
25S	200 & 320	120 & 240																																											
Form	Class	Volts																																											
1S	100	120 & 240																																											
2S	200 & 320	240																																											
3S & 3CS	20	120 & 240																																											
4S	20	240																																											
12S	200 & 320	120 & 240																																											
25S	200 & 320	120 & 240																																											
3	Soft-Switches to upgrade meter function	<ul style="list-style-type: none"> Optional Softswitches can be loaded in the factory or by the user to activate advanced functions O₂ – Activates communication capability with AMR/AMI modules S₂ – AMI/AMR calculated demand displayed on meter LCD V₂ – Simple Voltage Event monitor in addition to a display of RMS momentary voltage on the 3 lower LCD digits 	<ul style="list-style-type: none"> Optional Soft-switches can be loaded in the factory or by the user to activate advanced functions A₂ – Activates communication capability with AMR/AMI modules E₂ – Activates Event Log Recording (up to 200 Events) K₂ – Activates Reactive/Apparent Energy Consumption recording N₂ – Activates Demand Q₂ – Activates Instrument Recording R₂ – Activates LP recording (up to 4 channels) T₂ – Activates TOU recording V₂ – Activates Sag/Swell monitor and recording 																																										
4	AMR Interface (Factory enabled or installed by customer)	<ul style="list-style-type: none"> Quadrature Pulse SPI Format-1 data SPI Format-2 data PSEM Communications 	<ul style="list-style-type: none"> PSEM Communications 																																										
5	Energy Accumulation	<ul style="list-style-type: none"> Must specify at time of order either: <ul style="list-style-type: none"> Delivered only Delivered + Received Delivered - Received Received only Customer can change selection later using MeterMate 	<ul style="list-style-type: none"> Specified at time of order for factory programmed meters or configured by the customer using MeterMate. Any two or four of the following energy measurements can be selected: <ul style="list-style-type: none"> Delivered only kWh Received only kWh Delivered + received kWh Delivered - received kWh Lagging only kvarh; requires K₂ Soft-switch Leading only kvarh; requires K₂ Soft-switch Lagging + Leading kvarh; requires K₂ Soft-switch Lagging - Leading kvarh; requires K₂ Soft-switch Phasor apparent VAh; requires K₂ Soft-switch 																																										
6	Cycle Insensitive Demand	<ul style="list-style-type: none"> Not available 	<ul style="list-style-type: none"> Requires T₂ & N₂ Soft-switches to be enabled Provides an alternative method for calculating the maximum demand in meters equipped with one-way AMR system. The meter maintains the daily maximum demands and the two peaks for the period. Demand is calculated using the programmed method (Block, rolling or thermal). The daily maximum demands are stored in a circular queue. Each entry in the circular queue contains a date. 																																										
7	Power Quality	<ul style="list-style-type: none"> With V₂ Softswitch enabled, provides a count of Sag/Swell Events. Value and duration thresholds are programmable. 	<ul style="list-style-type: none"> With Q₂ and R₂ Softswitches enabled, Min, Max and Average Voltage recording is possible. With V₂ Softswitch enabled, provides counts and magnitude recording of Sag/Swell Events with date and time stamped. Value and duration thresholds are programmable. This Sag/Swell Event Log is separate from the Event Log recording provided by the E₂ Softswitch With E₂, R₂ and T₂ Softswitches enabled, recording of sustained and total outage counts and duration is possible to permit calculation of IEEE Reliability indices. 																																										
8	Back-up power	<ul style="list-style-type: none"> Not available 	<ul style="list-style-type: none"> Back-up power is used to maintain the meter clock during outages. If the R2 or T2 softswitch is required, one of the following back-up power options must be selected. <ul style="list-style-type: none"> Battery Supercap Batteryless operation. For batteryless operation, the AMI system must be able to re-synchronize the meter clock after a power outage 																																										
9	Service Switch (provide remote controllable disconnection and reconnection of electrical service for residential applications)	<ul style="list-style-type: none"> A switching device intended to provide remote controllable disconnection and reconnection of electrical service for residential applications. Factory installed option, specify at time of order. Full functionality requires two-way AMI module Switch is installed under standard size cover Typical applications include: <ul style="list-style-type: none"> Remote disconnect and reconnect of service Energy conservation demand limiting Demand limiting as an alternative to service disconnection Prepayment metering Outage management/restoration <p>Note: Energy conservation demand limiting and prepayment metering functionalities are not available on forms 12S and 25S.</p>	<ul style="list-style-type: none"> A switching device intended to provide remote controllable disconnection and reconnection of electrical service for residential applications. Factory installed option, specify at time of order. Full functionality requires two-way AMI module Switch is installed under standard size cover Typical applications include: <ul style="list-style-type: none"> Remote disconnect and reconnect of service Energy conservation demand limiting Demand limiting as an alternative to service disconnection Prepayment metering Outage management/restoration 																																										

Residential Electrical Metering

Technical Specifications

I-210+c

Basic Functions
Single Phase Demand Meter
- Energy management, 4 quantities
- Demand, block, or rolling demand
- Fundamental plus harmonic measurements
- Bi-directional energy measurements
Load Profile recording
Time of Use Billing Measures
Four Energy options (Delivered, Received, Delivered+Received, Delivered-Received)
Tamper detect capability
Broad communication module options
Network applications
Models available for 120 or 240 volt CL 20, CL 100, CL 200, CL 320 applications.
50 or 60 Hz operation

Optional Functions
Factory integrated Service Switch Capability

Soft-Switch Functions
A ₁ Soft-switch
- The Alternate Communication Soft-switch allows a communication option board to communicate with the meter
E ₁ Soft-switch
- The Event Log Soft-switch allows the meter to track the most recent 200 events. Use MeterMate™ Program Manager, Diagnostics Editor, to select the event types to be logged and how many occurrences should be tracked, up to a maximum of 200 events. Date and time stamps are included on logged events for Demand/LP or TOU meters
K ₁ Soft-switch
- The kVA and kvar Soft-switch adds kVA(h) and kvar(h) measurement capability.
N ₁ Soft-switch
- The Demand (N ₁) Soft-switch adds billing demand calculations.
Q ₁ Soft-switch
The Instrumentation Measurements Soft-switch enables
- Voltage (L-N): VA (max, min, store) for summations, demand, and load profile recording
- RMS voltage measurement for reading and display
- Low potential caution
- Temperature (max, min, avg) load profile recording
R ₁ Soft-switch
- The Load Profile Soft-switch activates up to 4 channels of LP recording
T ₁ Soft-switch
The Time-of-use Soft-switch enables TOU operation
- Up to four TOU periods and four Seasons
- Up to three daily rate schedule types and one holiday schedule
- Up to 80 TOU schedule set points
- Up to 50 programmable dates:
- Holidays, season changes, Daylight Savings Time (DST), self-read, and demand reset
- Perpetual calendar handles most dates
- Up to two billing and two demand measures per TOU period
- Self-read actions on specified dates, with or without a demand reset
V ₁ Soft-switch
- The voltage Soft-switch activates Sag/Swell monitor and recording

Accuracy
Typical Accuracy: Within +/- 0.2%
Starting Watts: 12W @ 240V, 6W @ 120V
Typical Watt Loss: 0.7 Watts

I-210+

Basic Functions
Basic function as electronic single phase Revenue Meter
Four Energy options (Delivered, Received, Delivered+Received, Delivered-Received)
Tamper detect capability
Broad communication module options
Network applications
Models available for 120 or 240 volt CL 20, CL 100, CL 200, CL 320 applications.
50 or 60 Hz operation.

Optional Functions
Factory integrated Service Switch Capability

Soft Switch Functions
AMR/AMI Communications (AMR/AMI Interface formats include quadrature pulse, PSEM, SPI Format-1 data, SPI Format-2 Data)
Display AMR calculated Demand value shown on the lower 3 LCD digits
Simple Voltage Event monitoring in addition to RMS momentary voltage display

Accuracy
Typical Accuracy: Within +/- 0.2%
Starting Watts: 12W @ 240V, 6W @ 120V
Typical Watt Loss: 0.7 Watts

Rating
Voltage: 120 V -240 V
Current: Class 100, Class 200, Class 320, Class 20
Frequency: 50 or 60 Hz

Cover Options
Polycarbonate cover with molded sunshield
- Plain cover without RESET OR "D" ring
- With Optocom "D" ring
- With RESET latch and Optocom "D" ring

Operating Range
Voltage: +/- 20%
Operates over a broad temperature range (-40C through +85C under the cover)

Available Models
ANSI Form 1S, 2S, 3S, 4S, 12S, 25S
CL 20, CL100, CL200, CL320

Applicable Standards
Performance meets or exceeds industry standards
ANSI C12.19
ANSI C12.1
ANSI C12.10
ANSI C12.20
ANSI C37.90.1
UL 2735

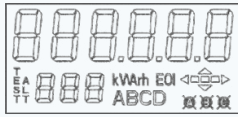
LCD Display
6 large characters to display the main programmed metering quantities

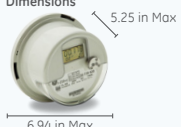
Weights and Dimensions	
Dimensions	
	
Approximate Weight	
Meters with service disconnect	
- Individual meter	2.0 - 2.4 lbs
- 4 meter pack	9.0 - 10.6 lbs
- Pallet (120 meters)	285 - 340 lbs
Meters without service disconnect	
- Individual meter	1.3 - 1.7 lbs
- 4 meter pack	6.2 - 7.8 lbs
- Pallet (120 meters)	200 - 255 lbs

Rating
Voltage: 120 V -240 V
Current: Class 100, Class 200, Class 320, Class 20
Frequency: 50 or 60 Hz

Cover Options
Polycarbonate cover with molded sunshield
- Plain cover without RESET OR "D" ring
- With Optocom "D" ring



Operating Range
Voltage: +/- 20%
Operates over a broad temperature range (-40C through +85C under the cover)

Available Models
ANSI Form 1S, 2S, 3S, 4S, 12S, 25S
CL 20, CL100, CL200, CL320

Applicable Standards
Performance meets or exceeds industry standards ANSI C12.1
ANSI C12.10
ANSI C12.20
ANSI C37.90.1

Technical Specifications

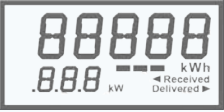
I-210+ (cont'd)

LCD Display	
5 large characters to display the billing quantities	
	
Weights and Dimensions	
Dimensions 6.94 in Max  5.25 in Max	
Approximate Weight	
Meters with service disconnect	
- Individual meter	2.0 - 2.4 lbs
- 4 meter pack	9.0 - 10.6 lbs
- Pallet (120 meters)	285 - 340 lbs
Meters without service disconnect	
- Individual meter	1.3 - 1.7 lbs
- 4 meter pack	6.2 - 7.8 lbs
- Pallet (120 meters)	200 - 255 lbs

Visit the Digital Energy Online Store: store.gedigitalenergy.com

A wide range of product solutions available for online ordering

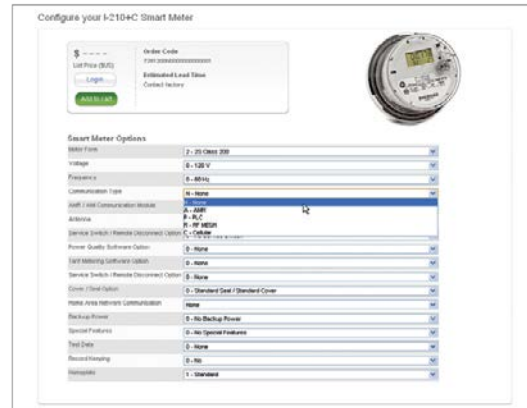
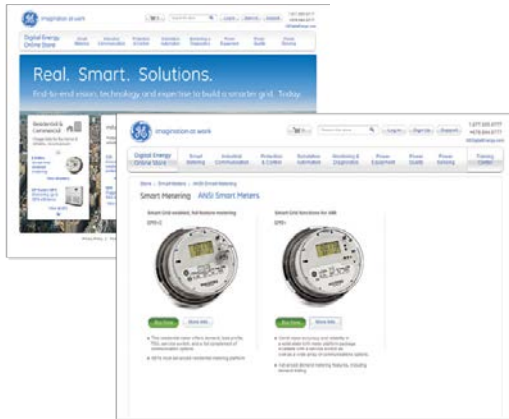

GE Digital Energy
2018 Powers Ferry Road
Atlanta, GA 30339
Toll Free (NA Only): 1-877-605-6777
Tel: 678-844-6777

GEDigitalEnergy.com

GE reserves the right to make changes to specifications of products described at any time without notice and without obligation to notify any person of such changes.

GE, the GE monogram, MeterMate, PowerOn and GridIQ are trademarks of the General Electric Company.

Copyright 2015, General Electric Company. All Rights Reserved.

GEA-12672E(E)
English
150615



**TAMPA ELECTRIC COMPANY
DOCKET NO: 150213-EI
STAFF'S 1ST DATA REQUEST
REQUEST NO. 14
PAGE: 1 OF 1
FILED: OCTOBER 27, 2015**

- 14.** Please describe the customer interface to access the information from the new utility installed meter, including:
- a. Whether the site would be secure and, if so how would it be secured;
 - b. Whether the information from the new meter could be used to verify production to allow the customer to receive renewable energy credits; and
 - c. Whether the customer would retain ownership of renewable energy credits.
- A.**
- a. Yes. It will be secured through a third party hosted solution.
 - b. The metering requirements for renewable energy credit verification vary based on the purchasing or trading entity. It is up to the customer to find a purchaser for renewable energy credits and to determine what type of monitoring is required for the transaction.
 - c. Yes. The customer would retain ownership of renewable energy credits associated with their renewable generating system.

**TAMPA ELECTRIC COMPANY
DOCKET NO: 150213-EI
STAFF'S 1ST DATA REQUEST
REQUEST NO. 15
PAGE: 1 OF 2
FILED: OCTOBER 27, 2015**

15. Please describe what TECO intends to do with the information gathered (Paragraph 4 of the petition and paragraph 4(d) of Exhibit A), including a description of the following:
- a. Research;
 - b. Forecasting; and
 - c. "Other business needs." TECO has
- A. Unlike other self-generating customers who self-supply a substantial portion of their own energy needs and are interconnected with Tampa Electric's grid, customers who install rooftop solar do not have utility meters measuring the output of their generators. As the number of such customers has substantially increased in recent years Tampa Electric is concerned about not understanding the output impacts of such distributed generation, not under its control, on the company's grid in general and distribution system in particular. The information gathered from these meters is intended to begin bridging that gap.
- a. For research purposes, Tampa Electric desires to better understand the output of residential rooftop solar, in conjunction with the residential house usage behind the utility meter. Knowing the in and out energy flows through the utility net meter does not provide sufficient information to provide that understanding – only adding a comparable meter to the output of the generator can provide the full picture. This information will permit better understanding of the impact of such loads on the company's distribution system for local load planning and design of the protection devices on the distribution and substation systems of the company. In addition, having a utility quality meter on the customer's generator will provide comparison data to compare against the multiple inverter derived meter recordings of generator output that the customer may be getting from their own system. Providing access to this data to the AMP customers will engage a dialogue between them and the company regarding the accuracy of their recorded data and its value to them as well as its value as a potential source of planning data for the company. The company will also be able to measure the output characteristics of the various types of solar generators installed within Tampa Electric's territory, knowing the direction facing the sun and potential obstructions (like trees or neighboring structures) to determine actual achieved generator output versus nameplate generator output.

**TAMPA ELECTRIC COMPANY
DOCKET NO: 150213-EI
STAFF'S 1ST DATA REQUEST
REQUEST NO. 15
PAGE: 2 OF 2
FILED: OCTOBER 27, 2015**

- b. As solar continues to expand within the Tampa Electric footprint, it is becoming a more and more substantial impact on the company's load and energy forecasting modeling – both for system forecast and also for distribution circuit planning purposes. The data collected is expected to provide better insight into the impact of such expanding development over time and provide more accurate load forecasts which drive generation and transmission expansion plans.

- c. Tampa Electric has other business needs to which this information will be applied. One such is to better understand the customer and what is driving their investment plans for the home in order to better serve those customers and provide enhances customer satisfaction. Another would be to better understand the economics of residential rooftop solar in order to provide more educated advice to customers who may be considering such an investment. Knowing just how well such solar generation will perform versus how it is being marketed to uneducated customers will enable customers to make better informed decisions as they consider such investments. Such increased understanding will also provide Tampa Electric the ability to better engage with the residential solar rooftop developers who are doing business in our area with advice about the impact of their developments on local areas that may require distribution line capacity upgrades. As the AMP program progresses, it could be expected that the information acquired will lead to the identification of other business needs and opportunities for Tampa Electric.

**TAMPA ELECTRIC COMPANY
DOCKET NO: 150213-EI
STAFF'S 1ST DATA REQUEST
REQUEST NO. 16
PAGE: 1 OF 1
FILED: OCTOBER 27, 2015**

- 16.** Paragraph 5 of TECO's petition describes a new advanced meter to be installed on non-PV installations.
- a. Please state whether this would be the same meter installed on solar photovoltaic systems. If not, please describe how the non-PV meter differs from that installed on PV installations.
 - b. Please state when TECO plans to commence with full deployment .
 - c. Please state whether advanced meters have been installed on homes without PV installations and, if so, how many.
 - d. Please state the number of additional advanced meters TECO plans to install prior to full deployment.
 - e. Please explain how customers without PV installations are chosen to receive advanced meters prior to full deployment.
- A.**
- a. It is a different meter. The solar photovoltaic generator meters are a proprietary Nighthawk meter that allows the data to be housed in a hosted secure third party site. This will allow the customer to have access to their generation data. The meters that are being used for residences without a solar photovoltaic generator will be a GE meter with a meshing communication through a Trilliant network.
 - b. Commencement of full deployment is being evaluated at this time with no specific date yet for full deployment. The purpose of the pilot is to better understand AMI and its impacts/benefits to our customers, investors, and our system.
 - c. None to date
 - d. This partial deployment will be less than 5000 meters.
 - e. They will be selected based on a geographic location where the communication infrastructure is available.