

 RECEIVED-FPSC

99 OCT 14 PM 4:38

RECORDS AND REPORTING  
October 14 1999

Susan S. Masterton  
Attorney

ORIGINAL

VP Law/External Relations  
Post Office Box 2214  
Tallahassee, FL 32316-2214  
Voice 850 599 1560  
Fax 850 878 0777  
susan.masterton@mail.sprint.com

Ms. Blanca S. Bayo, Director  
Division of Records and Reporting  
Florida Public Service Commission  
2540 Shumard Oak Boulevard  
Tallahassee, Florida 32399-0850

RE: Notice of Adoption of MCImetro/Sprint  
Interconnection Agreement by Maxcess, Inc.

991595-7P

Dear Ms. Bayo:

Sprint-Florida, Incorporated hereby provides notice to the Florida Public Service Commission of the adoption by Maxcess, Inc., of the Interconnection and Resale Agreement for the State of Florida entered into by and between Sprint-Florida Incorporated and MCImetro, Inc. and approved by the Commission on May 20, 1997. Maxcess, Inc., is adopting the agreement as provided by Section 252(i) of the Telecom Act of 1996. Enclosed is the original signed and five (5) copies of the agreement between Sprint-Florida and Maxcess, Inc. for your records.

Thank you for your assistance in this matter. If you have any questions, please do not hesitate to contact me at (850) 599-1560.

Sincerely,

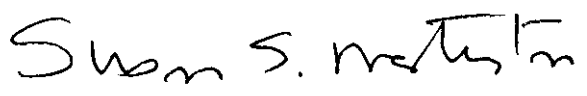

Susan S. Masterton

Enclosures

cc: Walter D'Haeseleer  
Victor Cordiano

RECEIVED & FILED  
  
FPSC-BUREAU OF RECORDS

DOCUMENT NUMBER-DATE  
12543 OCT 14 99  
FPSC-RECORDS/REPORTING

## **Master Network Interconnection and Resale Agreement**

This Master Network Interconnection and Resale Agreement ("Agreement") between Maxcess, Inc., and Sprint – Florida, Incorporated, a Florida Corporation (Sprint), herein collectively, "the Parties", is entered into and effective this 1st day of October, 1999 for the State of Florida.

NOW THEREFORE, the parties agree as follows:

The Parties agree that the Agreement between the Parties shall consist of the Interconnection and Resale Agreement for the State of Florida entered into by and between Sprint and MCImetro Access Transmission Services, Inc. (MCI<sub>m</sub>) and filed with the Florida Public Service Commission on the 7<sup>th</sup> day of April, 1997 (herein the "MCI<sub>m</sub> Agreement"), amended as follows:

### **TERM:**

This agreement shall be in force until the 7<sup>th</sup> day of April, 2000.

### **RATES:**

All rates provided under this agreement include the subsequent amendments executed by Sprint and MCI<sub>m</sub>.

### **CONDITIONS:**

All services provided under this agreement will be consistent with the Rulings of the 8<sup>th</sup> Circuit Court.

### **NOTICES:**

Except as otherwise provided, all notices and other communication hereunder shall be deemed to have been duly given when made in writing and delivered in person or deposited in the United States mail, certified mail, postage paid, return receipt requested and addressed as follows:

To Maxcess, Inc.

Joe Isaacs  
ISG-Telecom  
838 Village Way Suite 1200  
Palm Harbor, Florida 34683

Copy To:

Jim Marchant  
Maxcess, Inc.  
14119 West Newberry Road  
Newberry, Florida 32669

To Sprint:

Director - Carrier Markets  
Mailstop: KSFRWB0301  
Sprint  
4220 Shawnee Mission Parkway  
Fairway, KS 66205  
Facsimile: 913-624-1325

Copy To:

Sprint  
Regional Director - Carrier Markets  
555 Lake Border Drive  
Apopka, FL 32703  
Facsimile: 407-889-6779

Maxcess, Inc. is hereby substituted in the MCI Agreement for MCI and Sprint is substituted for Company. The Agreement shall be modified as identified above and in all other respects the MCI Agreement shall remain unchanged.

IN WITNESS WHEREOF, the Parties thereto have caused this Agreement to be executed by their duly respective authorized representatives.

Sprint - Florida, Incorporated

Maxcess, Inc.

By: 

By: 

Name: Gregg H. Brown \_\_\_\_\_

Name: Jim Marchant \_\_\_\_\_

Title: Regional Director \_\_\_\_\_

Title: PRESIDENT \_\_\_\_\_

Date: 10/7/99 \_\_\_\_\_

Date: 9/30/99 \_\_\_\_\_

ATTACHMENT: Interconnection and Resale Agreement for the State of Florida entered into by and between Sprint and MCI metro Access Transmission Services, Inc. filed with the Florida Public Service Commission on the 7<sup>th</sup> day of April, 1997.

## **MCImetro/SPRINT INTERCONNECTION AGREEMENT 1997**

This MCImetro/Sprint Interconnection Agreement 1997 (the "Agreement"), effective [insert date], 1997 (the "Effective Date"), is entered into by and between MCImetro Access Transmission Services, Inc. ("MCIIm"), a Delaware corporation, [on behalf of itself and its Affiliates,] and Sprint-Florida, Incorporated ("Sprint"), a Florida corporation, to establish the rates, terms and conditions for Local Interconnection, Local Resale, and purchase of unbundled Network Elements (individually referred to as the "service" or collectively as the "services").

WHEREAS, the Parties wish to interconnect their local exchange networks in a technically and economically efficient manner for the transmission and termination of calls so that customers of each Party can seamlessly receive calls that originate on the other's network and place calls that terminate on the other's network, and for MCIIm's use in the provision of exchange access ("Local Interconnection"); and

WHEREAS, MCIIm wishes to purchase Telecommunications Services for resale to others ("Local Resale" or "Services for Resale") and Sprint is willing to provide such service; and

WHEREAS, MCIIm wishes to purchase on an unbundled basis Network Elements, ancillary services and functions, and additional features ("Network Elements"), separately or in any combination, and to use such services for itself or for the provision of its Telecommunications Services to others, and Sprint is willing to provide such services; and

WHEREAS, the Parties intend the rates, terms and conditions of this Agreement, and their performance of obligations thereunder to comply with the Communications Act of 1934, as amended by the Telecommunications Act of 1996 (the "Act"), the Rules and Regulations of the Federal Communications Commission ("FCC"), and the orders, Rules and Regulations of the Florida Public Service Commission (the "Commission");

NOW, THEREFORE, in consideration of the terms and conditions contained herein, MCIIm and Sprint hereby mutually agree as follows:

CERTIFICATE OF SERVICE

I HEREBY CERTIFY that a copy of the foregoing was furnished to the following parties by hand delivery or by UPS Overnight Delivery (\*) this 14th day of April, 1997.

Jerry M. Johns (\*)  
United Telephone Co. of Fla.  
Central Telephone Co. of Fla.  
555 Lake Border Drive  
Apopka, FL 32703

John P. Fons  
J. Jeffrey Wahlen  
Ausley & McMullen  
227 S. Calhoun Street  
Tallahassee, FL 32301

Charles Rehwinkel  
Sprint Communications  
1313 Blairstone Road  
Tallahassee, FL 32301

Martha Carter Brown  
Division of Legal Services  
Florida Public Service Commission  
2540 Shumard Oak Boulevard  
Tallahassee, FL 32399

*Pie O. Mc*

---

Attorney

HOPPING GREEN SAMS & SMITH  
PROFESSIONAL ASSOCIATION

ATTORNEYS AND COUNSELORS

123 SOUTH CALHOUN STREET

POST OFFICE BOX 6526

TALLAHASSEE, FLORIDA 32314

(904) 222-7500

FAX (904) 224-8551

FAX (904) 425-3415

Writer's Direct Dial No.

(904) 425-2313

April 14, 1997

GARY K. HUNTER, JR.  
JONATHAN T. JOHNSON  
ROBERT A. MANNING  
ANGELA R. MORRISON  
GARY V. PERKO  
KAREN M. PETERSON  
R. SCOTT RUTH  
W. STEVE SYKES  
T. KENT WETHERELL, II

OF COUNSEL  
W. ROBERT FOKES

JAMES S. ALVES  
BRIAN H. BIBEAU  
KATHLEEN BLIZZARD  
ELIZABETH C. BOWMAN  
RICHARD S. BRIGHTMAN  
PETER C. CUNNINGHAM  
RALPH A. DEMEO  
THOMAS M. DE ROSE  
WILLIAM H. GREEN  
WADE L. HOPPING  
FRANK E. MATTHEWS  
RICHARD D. NELSON  
MICHAEL P. PETROVICH  
DAVID L. POWELL  
WILLIAM D. PRESTON  
CAROLYN S. RAEPPEL  
DOUGLAS S. ROBERTS  
GARY P. SAMS  
ROBERT P. SMITH  
CHERYL G. STUART

Ms. Blanca S. Bayó  
Director, Records and Reporting  
Florida Public Service Commission  
2540 Shumard Oak Boulevard  
Tallahassee, FL 32399-0850

Re: Docket No. 961230-TP

Dear Ms. Bayó:

Enclosed for filing, by this joint submittal, are the original and fifteen copies of the MCImetro/Sprint Interconnection Agreement 1997 ("Agreement"). This Agreement is being filed pursuant to Order No. PSC-97-0294-FOF-TP, which requires the parties to file their written agreement within 30 days of the date of the issuance of the order. As a result of this filing, Sprint's pending motion for extension of time can be regarded as moot.

The Agreement has not yet been fully executed due to the logistical difficulties of getting authorized signatures. The parties expect to submit original signature pages to the Commission within a few days.

The Agreement is a hybrid of negotiation and arbitration. Some aspects were negotiated prior to arbitration. Other aspects were contingent upon Commission decisions in other arbitration dockets. Still others were the result of Commission decisions in this arbitration docket. Finally, portions of the agreement were negotiated subsequent to the Commission vote and are intended to supplant those aspects of the arbitration decision.

The parties believe that the resulting Agreement should be approved as an arbitrated agreement pursuant to Section 252(e) of the Telecommunications Act of 1996.

The filing of the Agreement does not affect Sprint's pending motion for reconsideration of Order No. PSC-97-0294-FOF-TP. Pursuant to Section 2.2 of the Agreement, the parties will amend

Ms. Blanca Bayó  
April 14, 1997  
Page 2

the Agreement as appropriate to incorporate the results of any order on reconsideration.

If you have any questions regarding this filing, please do not hesitate to call.

Sincerely,



Charles J. Rehwinkel  
For Sprint-Florida, Inc.

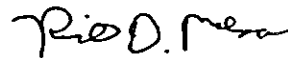

Richard D. Melson  
For MCI metro Access Transmission  
Services, Inc.

RDM/mee  
Enclosure

MCImetro Access Transmission  
Services, Inc.

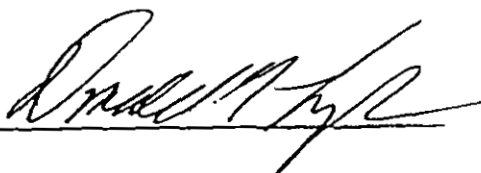
By: 

Name: Donald T. Lynch

Title: Senior Vice-President

Date: 4/15/97.

Sprint-Florida, Incorporated

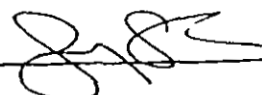
By: 

Name: Jerry Johns

Title: VP - Law & External Relations

Date: 4/16/97



CERTIFICATE OF SERVICE

I HEREBY CERTIFY that a copy of the foregoing was furnished to the following parties by hand delivery or by UPS Overnight Delivery (\*) this 16th day of April, 1997.

Jerry M. Johns (\*)  
United Telephone Co. of Fla.  
Central Telephone Co. of Fla.  
555 Lake Border Drive  
Apopka, FL 32703

John P. Fons  
J. Jeffry Wahlen  
Ausley & McMullen  
227 S. Calhoun Street  
Tallahassee, FL 32301

Charles Rehwinkel  
Sprint Communications  
1313 Blairstone Road  
Tallahassee, FL 32301

Martha Carter Brown  
Division of Legal Services  
Florida Public Service Commission  
2540 Shumard Oak Boulevard  
Tallahassee, FL 32399



\_\_\_\_\_  
Attorney

**PART A – GENERAL TERMS AND CONDITIONS*****Section 1. Scope of this Agreement***

1.1 This Agreement, including Parts A, B, and C, specifies the rights and obligations of each Party with respect to the purchase and sale of Local Interconnection, Local Resale and Network Elements. This Part A sets forth the general terms and conditions governing this Agreement. Certain terms used in this Agreement shall have the meanings defined in Part B -- Definitions, or as otherwise elsewhere defined throughout this Agreement. Other terms used but not defined herein will have the meanings ascribed to them in the Act and the FCC's Rules and Regulations. Part C sets forth, among other things, descriptions of the services, pricing, technical and business requirements, and physical and network security requirements.

**LIST OF ATTACHMENTS COMPRISING PART C:**

- I. Price Schedule
- II. Local Resale
- III. Network Elements
- IV. Interconnection
- V. Collocation
- VI. Rights of Way
- VII. Number Portability
- VIII. Business Process Requirements
- IX. Credits for Performance Standards Failures

1.2 Sprint shall provide the services pursuant to this Agreement. Sprint shall provide the services in any combination requested by MCI. Sprint shall not discontinue any service provided or required hereunder without providing MCI prior written notice of such discontinuation of service. Sprint agrees to cooperate with MCI with any transition resulting from such discontinuation of service and to minimize the impact to customers which may result from such discontinuance of service. Sprint will not discontinue any Network Element or Combination provided hereunder or reconfigure, reengineer or otherwise redeploy its network in a manner which affects MCI's service provided using Network Elements or Combinations provided hereunder or Telecommunications Services provided hereunder, except in connection with network changes and upgrades where Sprint: (i) complies with Sections 51.325 through 51.335 of Title 47 of the Code of Federal Regulations; (ii) with respect to discontinued Network Elements or Combinations, cooperates with MCI and uses reasonable efforts to determine a reasonable alternative, if one exists, to the Network Element or Combination which is to be discontinued

and to implement such alternative prior to discontinuance of such Network Element or Combination; and (iii) with respect to a network change, cooperates with MCI to find a reasonable alternative, if one exists, to the changed network to allow MCI to provide Telecommunications Services as if the change was not made. Sprint agrees that all obligations undertaken pursuant to this Agreement, including without limitation, performance standards, intervals, and technical requirements are material obligations.

## **Section 2. *Regulatory Approvals***

2.1 This Agreement, and any amendment or modification hereof, will be submitted to the Commission for approval in accordance with Section 252 of the Act. Sprint and MCI shall use their best efforts to obtain approval of this Agreement by any regulatory body having jurisdiction over this Agreement and to make any required tariff modifications. MCI shall not order services under this Agreement until such Commission approval has been obtained or as may otherwise be agreed in writing between the Parties. In the event any governmental authority or agency rejects any provision hereof, the Parties shall negotiate promptly and in good faith such revisions as may reasonably be required to achieve approval.

2.2 In the event the FCC or the Commission promulgates rules or regulations or issues orders, or a court with appropriate jurisdiction issues orders which conflict with or make unlawful any provision of this Agreement, the Parties shall negotiate promptly and in good faith in order to amend the Agreement to substitute contract provisions which are consistent with such rules, regulations or orders. In the event the Parties cannot agree on an amendment within thirty (30) days from the date any such rules, regulations or orders become effective, then the Parties shall resolve their dispute under the applicable procedures set forth in Section 23 (Dispute Resolution Procedures) hereof.

2.3 In the event Sprint is required by any governmental authority or agency to file a tariff or make another similar filing in connection with the performance of any action that would otherwise be governed by this Agreement, Sprint shall: (i) use best efforts to consult with MCI reasonably in advance of such filing about the form and substance of such filing; (ii) provide to MCI its proposed tariff prior to such filing; and (iii) take all steps reasonably necessary that do not conflict with such governmental authority or agency requirement to ensure that such tariff or other filing imposes obligations upon Sprint that are as close as possible to those provided in this Agreement and preserve for MCI the full benefit of the rights otherwise provided in this Agreement. Except as otherwise permitted under this Section 2.3, in no event shall Sprint file any tariff that

purports to govern the services provided hereunder that is inconsistent with the rates and other terms and conditions set forth in this Agreement. The other services covered by this Agreement and not covered by such decision or order shall remain unaffected and shall remain in full force and effect. Notwithstanding the foregoing, nothing in this Agreement shall be deemed or construed to prohibit Sprint from charging rates to MCIIm under this Agreement if such rates are cost-based rates adopted by Sprint following approval of such rates by the Commission in a generic cost proceeding in which MCIIm has or had the opportunity to participate, which generic cost proceeding may have been initiated by Sprint by a tariff filing or otherwise.

2.4 The Parties intend that any additional services requested by either Party relating to the subject matter of this Agreement will be incorporated into this Agreement by amendment.

### ***Section 3. Term of Agreement***

This Agreement shall become binding upon the Effective Date and continue for a period of three (3) years from the Commission approval date ("Approval Date"), unless earlier terminated or withdrawn in accordance with Section 20 (Termination). Renewal after the initial term for successive one (1) year terms shall be at MCIIm's option upon written notice to Sprint.

### ***Section 4. Charges and Payment***

In consideration of the services provided by Sprint under this Agreement, MCIIm shall pay the charges set forth in Attachment I subject to the provisions of Section 2.3 hereof. The billing and payment procedures for charges incurred by MCIIm hereunder are set forth in Attachment VIII.

### ***Section 5. Assignment and Subcontract***

5.1 Any assignment of any right, obligation or duty, or of any other interest hereunder, in whole or in part, by either Party to any non-affiliated entity, without the prior written consent of the other Party shall be void. A Party assigning this Agreement or any right, obligation, duty or other interest hereunder to an Affiliate shall provide written notice to the other Party. All obligations and duties of any Party under this Agreement shall be binding on all successors in interest and assigns of such Party. No assignment hereof shall relieve the assignor of its obligations under this Agreement.

5.2 If any obligation is performed by a subcontractor or Affiliate, Sprint shall remain fully responsible for the performance of this Agreement in

accordance with its terms. MCIIm may request the dismissal of a subcontractor in the event MCIIm reasonably believes such subcontractor is not properly performing services hereunder. Sprint shall respond to such request within seven (7) business days from receipt thereof.

5.3 Notwithstanding the above, should Sprint sell or trade substantially all the assets in an exchange or group of exchanges that Sprint uses to provide Telecommunications Services, then:

5.3.1 If the acquiring party is an Incumbent Local Exchange Carrier ("ILEC") in that state and MCIIm already has an interconnection and/or resale agreement with that ILEC, then this Agreement shall terminate on the closing date of the sale or trade with regard to the relevant exchange(s); or

5.3.2 In the event the acquiring Party is not an ILEC in that state, or is an ILEC in that state but does not have an interconnection and/or resale agreement with MCIIm, then Sprint shall have the right to assign its rights, obligations, and duties under this Agreement with regard to the relevant exchange(s) without MCIIm's permission to the acquirer of such assets, provided the acquirer has assumed the rights, duties, and obligations of Sprint.

#### ***Section 6. Compliance with Laws***

All terms, conditions and operations under this Agreement shall be performed in accordance with all applicable laws, regulations and judicial or regulatory decisions of all duly constituted governmental authorities with appropriate jurisdiction, and this Agreement shall be implemented consistent with the FCC's First Report and Order in CC Docket No. 96-98, released August 8, 1996 and FCC's Second Report and Order in CC Docket No. 96-98, released August 8, 1996, as amended from time to time (the "FCC Interconnection Order"). Each Party shall be responsible for obtaining and keeping in effect all FCC, state regulatory commission, franchise authority and other regulatory approvals that may be required in connection with the performance of its obligations under this Agreement. In the event the Act or FCC Rules and Regulations applicable to this Agreement are held invalid, this Agreement shall survive, and the Parties shall promptly renegotiate any provisions of this Agreement which, in the absence of such invalidated Act, rule or regulation, are insufficiently clear to be effectuated.

**Section 7. Governing Law**

This Agreement shall be governed by and construed in accordance with the Act and the FCC's Rules and Regulations, except insofar as state law may control any aspect of this Agreement, in which case the domestic laws of the State of Florida, without regard to its conflicts of laws principles, shall govern.

**Section 8. Relationship of Parties**

It is the intention of the Parties that Sprint be an independent contractor and nothing contained herein shall constitute the Parties as joint venturers, partners, employees or agents of one another, and neither Party shall have the right or power to bind or obligate the other.

**Section 9. No Third Party Beneficiaries**

The provisions of this Agreement are for the benefit of the Parties hereto and not for any other person; provided, however, that this shall not be construed to prevent MCI from providing its Telecommunications Services to other carriers. This Agreement shall not provide any person not a Party hereto with any remedy, claim, liability, reimbursement, claim of action, or other right in excess of those existing without reference hereto.

**Section 10. Intellectual Property Rights and Indemnification**

10.1 Any intellectual property which originates from or is developed by a Party shall remain in the exclusive ownership of that Party. Except for a limited license to use patents or copyrights to the extent necessary for the Parties to use any facilities or equipment (including software) or to receive any service solely as provided under this Agreement, no license in patent, copyright, trademark or trade secret, or other proprietary or intellectual property right now or hereafter owned, controlled or licensable by a Party, is granted to the other Party or shall be implied or arise by estoppel. It is the responsibility of each Party to ensure, at no separate, additional cost to the other Party, that it has obtained any necessary licenses in relation to intellectual property of third parties used in its network that may be required to enable the other Party to use any facilities or equipment (including software), to receive any service, or to perform its respective obligations under this Agreement. For the avoidance of doubt, the foregoing sentence shall not preclude Sprint from charging MCI for such costs as permitted under a Commission order.

10.2 The Party providing a service pursuant to this Agreement will defend the Party receiving such service or data provided as a result of such service against claims of infringement arising solely from the use by the receiving Party of such service and will indemnify the receiving Party for

any damages awarded based solely on such claims in accordance with Section 11 of this Agreement.

### ***Section 11. Indemnification***

11.1 Notwithstanding any limitations in remedies contained in this Agreement, each Party (the "Indemnifying Party") will indemnify and hold harmless the other Party ("Indemnified Party") from and against any loss, cost, claim, liability, damage and expense (including reasonable attorney's fees) to third parties, relating to or arising out of the libel, slander, invasion of privacy, misappropriation of a name or likeness, negligence or willful misconduct by the Indemnifying Party, its employees, agents, or contractors in the performance of this Agreement or the failure of the Indemnifying Party to perform its obligations under this Agreement. In addition, the Indemnifying Party will, to the extent of its obligations to indemnify hereunder, defend any action or suit brought by a third party against the Indemnified Party.

11.2 The Indemnified Party will notify the Indemnifying Party promptly in writing of any written claim, lawsuit, or demand by third parties for which the Indemnified Party alleges that the Indemnifying Party is responsible under this Section 11 and tender the defense of such claim, lawsuit or demand to the Indemnifying Party. The Indemnified Party also will cooperate in every reasonable manner with the defense or settlement of such claim, demand, or lawsuit. The Indemnifying Party shall keep the Indemnified Party reasonably and timely apprised of the status of the claim, demand or lawsuit. The Indemnified Party shall have the right to retain its own counsel, at its expense, and participate in but not direct the defense; provided, however, that if there are reasonable defenses in addition to those asserted by the Indemnifying Party, the Indemnified Party and its counsel may raise and direct such defenses, which shall be at the expense of the Indemnifying Party.

11.3 The Indemnifying Party will not be liable under this Section 11 for settlements or compromises by the Indemnified Party of any claim, demand, or lawsuit unless the Indemnifying Party has approved the settlement or compromise in advance or unless the defense of the claim, demand, or lawsuit has been tendered to the Indemnifying Party in writing and the Indemnifying Party has failed to promptly undertake the defense.

### ***Section 12. Limitation of Liability***

Neither Party shall be liable to the other for any indirect, incidental, special or consequential damages arising out of or related to this Agreement or the provision of service hereunder. Notwithstanding the foregoing limitation, a Party's liability shall not

be limited by the provisions of this Section 12 in the event of its willful or intentional misconduct, including gross negligence, or its repeated breach of any one or more of its material obligations under this Agreement. A Party's liability shall not be limited with respect to its indemnification obligations.

### **Section 13. Warranties**

13.1 Except as otherwise provided herein, each Party shall perform its obligations hereunder at a performance level no less than the highest level which it uses for its own operations, or those of its Affiliates, but in no event shall a Party use less than reasonable care in the performance of its duties hereunder.

13.2 As of the Approval Date, unless otherwise agreed in writing by MCI, Sprint warrants that Local Interconnection will be provided at Parity. Such Local Interconnection shall be provided on the basis set forth in Attachment IV. Sprint shall have the full burden of proving that a requested Interconnection Point ("IP") is not technically feasible. To the extent Sprint proves infeasibility, Sprint shall notify MCI if Sprint knows of, or if not, will cooperate with MCI to find, an alternative IP which will not impair MCI's ability to provide its Telecommunications Services.

13.3 As of the Approval Date, unless otherwise agreed in writing by MCI, Sprint warrants that it will provide to MCI on a nondiscriminatory basis, at Parity, unbundled Network Elements including, but not limited to, local loop, network interface device, local switching, tandem switching, interoffice transmission facilities, signaling networks and call-related databases, and operator services and directory assistance, at any technically feasible points requested by MCI, and all operations support systems used and useful in the preordering, ordering, provisioning, maintenance, billing, and repair associated directly or indirectly with unbundled Network Elements pursuant to an agreed-upon schedule. Sprint warrants that it will provide to MCI on a nondiscriminatory basis, at Parity, ancillary services including, but not limited to, 911 and basic directory listings, at any technically feasible points requested by MCI, and all operations support systems used and useful in the preordering, ordering, provisioning, maintenance, billing and repair associated directly or indirectly with such ancillary services pursuant to an agreed upon schedule. Sprint further warrants that these services, or their functional components, will contain all the same features, functions, and capabilities and be provided at a level of quality at least equal to the highest level which Sprint provides to itself or its Affiliates. Sprint shall have the full burden of proving that access requested by MCI is not technically feasible. To the extent Sprint proves: (i) infeasibility, or (ii) if feasible, that such access is proprietary to Sprint, Sprint shall notify MCI if Sprint



knows of, or if not, will cooperate with MCI to find, an alternative service which will not impair MCI's ability to provide its Telecommunications Services.

13.4 Sprint warrants that it will provide to MCI nondiscriminatory access to Poles, ducts, Conduits, and other Rights of Way, owned or controlled by Sprint, using capacity currently available or that can be made available. Sprint shall have the full burden of proving that such access is not technically feasible. To the extent Sprint proves infeasibility, Sprint shall notify MCI if Sprint knows of, or if not, will cooperate with MCI to find, suitable alternative access which will not impair MCI's ability to provide its Telecommunications Services.

13.5 Sprint warrants that it will provide nondiscriminatory access to telephone numbers.

13.6 Sprint warrants that it will provide to MCI, in a competitively-neutral fashion, interim number portability with the same features, functions and capabilities that Sprint provides to any other party including its Affiliates, and with as little impairment of functioning, quality, reliability, and convenience as possible, and that it will provide such service as required by the FCC in Telephone Number Portability, CC Docket No. 95-116, First Report and Order, released July 2, 1996, and Commission orders.

13.7 Sprint warrants that it will provide to MCI, in a competitively-neutral fashion, dialing parity for local exchange service and interexchange service with the same features, functions and capabilities that Sprint provides to itself or its Affiliates, as required by the FCC in Implementation of the Local Competition Provisions of the Telecommunications Act of 1996, Second Report and Order and Memorandum Opinion and Order, FCC 96-333, released Aug. 8, 1996, and relevant Commission orders and rules so that MCI's subscribers experience no greater post-dial delay than similarly-situated Sprint subscribers, and are not required to dial any greater number of digits than similarly-situated Sprint subscribers.

13.8 Sprint warrants that with respect to Local Resale, and upon implementation of electronic access to Sprint's operations support systems pursuant to an agreed-upon schedule, order entry, provisioning, installation, trouble resolution, maintenance, customer care, billing, and service quality will be provided at least as expeditiously as Sprint provides for itself or for its own retail local Telecommunications Service or to others, or to its Affiliates, and that it will provide such services to MCI in a competitively-neutral fashion and at a level of quality which allows MCI in turn to provide Local Resale at a level of quality equal to the highest level of quality Sprint provides for itself for its own retail local

Telecommunications Service or to others, or to its Affiliates. Sprint warrants further that it will impose no restrictions on MCI's resale of Telecommunications Services unless specifically sanctioned by the FCC or the Commission.

13.9 Sprint warrants that it will provide on a nondiscriminatory basis space on its premises for physical or virtual Collocation, as MCI may specify, for equipment necessary for MCI's interconnection and access to unbundled Network Elements as required by the FCC or the Commission.

13.10 The Bellcore, ANSI and other such standards referred to in this Agreement, and the Attachments and Appendices hereto, are guidelines established to inform the telecommunications industry about equipment specifications. Bellcore, ANSI, and other standards bodies do not warrant or guarantee that following the specifications set forth in such standards will produce the technical results or safety originally intended. Sprint agrees to adhere to the technical requirements contained in the Bellcore, ANSI, and other standards referred to herein, provided that the applicable standards will be those existing at the time the equipment to which the standards refer is placed into service by Sprint. With respect to such standards, Sprint agrees to provide MCI Parity for the functionality offered by Sprint pursuant to this Agreement. Sprint makes no representation or warranty, express or implied, with respect to the sufficiency, accuracy or utility of any information or opinion contained in the Bellcore, ANSI, and other such standards referred to in this Agreement, and the Attachments and Appendices hereto.

#### **Section 14. Notices**

Except as otherwise provided herein, all notices or other communication hereunder shall be deemed to have been duly given when made in writing and delivered in person or deposited in the United States mail, certified mail, postage prepaid, return receipt requested and addressed as follows:

To MCI: MCImetro Access Transmission Services, Inc.  
8521 Leesburg Pike  
Vienna, VA 22182

Copy to: General Counsel  
MCI Communications Corporation  
1801 Pennsylvania Ave, N.W.  
Washington, DC 20006

To Sprint: Director-Local Carrier Markets  
Sprint Local Telecommunications Division  
2330 Shawnee Mission Parkway  
Westwood, KS 66205

Mailstop: KSFRWA0301

Copy to: Vice President-Law and External Relations  
555 Lake Border Drive  
Apopka, FL 32703

If personal delivery is selected to give notice, a receipt of such delivery shall be obtained. The address to which notices or communications may be given to either Party may be changed by written notice given by such Party to the other pursuant to this Section 14.

## ***Section 15. Remedies***

### **15.1 Specific Performance**

15.1.1 In addition to any other rights or remedies, and unless specifically provided herein to the contrary, either party may sue in equity for specific performance.

15.2 In the event of a subscriber complaint of an unauthorized PLC record change where the Party that ordered such change is unable to produce appropriate documentation and verification as required by FCC and Commission rules (or, if there are no rules applicable to PLC record changes, then such rules as are applicable to changes in long distance carriers of record), such Party shall be liable to pay and shall pay all non-recurring charges associated with reestablishing the subscriber's local service with the original local carrier. Should Sprint fail to change a subscriber to MCI<sub>m</sub> pursuant to the terms of this agreement, and upon notice by MCI<sub>m</sub> to Sprint that such a failure occurred, then Sprint shall immediately change the subscriber to MCI<sub>m</sub> and shall waive all non-recurring charges normally associated with such a change.

15.3 Except as otherwise provided herein, all rights of termination, cancellation or other remedies prescribed in this Agreement, or otherwise available, are cumulative and are not intended to be exclusive of other remedies to which the injured Party may be entitled at law or equity in case of any breach or threatened breach by the other Party of any provision of this Agreement, and use of one or more remedies shall not bar use of any other remedy for the purpose of enforcing the provisions of this Agreement.

**Section 16. Waivers**

16.1 No waiver of any provisions of this Agreement and no consent to any default under this Agreement shall be effective unless the same shall be in writing and properly executed by or on behalf of the Party against whom such waiver or consent is claimed.

16.2 No course of dealing or failure of any Party to strictly enforce any term, right, or condition of this Agreement in any instance shall be construed as a general waiver or relinquishment of such term, right or condition.

16.3 Waiver by either Party of any default by the other Party shall not be deemed a waiver of any other default.

**Section 17. Survival**

The following provisions of this Part A shall survive the expiration or termination of this Agreement: Sections 10, 11, 12, 20.3, 20.4, 21, 22, 26 and 27.

**Section 18. Force Majeure**

18.1 Neither Party shall be held liable for any delay or failure in performance of any part of this Agreement from any cause beyond its control and without its fault or negligence, such as acts of God, acts of civil or military authority, embargoes, epidemics, war, terrorist acts, riots, insurrections, fires, explosions, earthquakes, nuclear accidents, floods, power blackouts, work stoppage affecting a supplier or unusually severe weather. No delay or other failure to perform shall be excused pursuant to this Section 18 unless delay or failure and consequences thereof are beyond the control and without the fault or negligence of the Party claiming excusable delay or other failure to perform. In the event of any such excused delay in the performance of a Party's obligation(s) under this Agreement, the due date for the performance of the original obligation(s) shall be extended by a term equal to the time lost by reason of the delay. In the event of such delay, the delaying Party shall perform its obligations at a performance level no less than that which it uses for its own operations. In the event of such performance delay or failure by Sprint, Sprint agrees to resume performance in a nondiscriminatory manner and not favor its own provision of Telecommunications Services above that of MCI.

18.2 During the pendency of a general strike by Sprint's employees, Sprint shall provide Local Service, Network Elements and Combinations to MCI at parity to the services provided by Sprint to its subscribers.

**Section 19. Non-Discriminatory Treatment**

19.1 If, at any time while this Agreement is in effect, Sprint provides any service provided under this Agreement to a Telecommunications Carrier, as defined in 47 Code of Federal Regulations Part 51.5, on terms different from those available under this Agreement, then MCI may opt to adopt such service upon the same rates, terms, and conditions as those provided to said Telecommunications Carrier in lieu of or in addition to the rates, terms and conditions applicable under this Agreement for its own arrangements with Sprint (hereinafter "MFN Obligations"). Subject to the last sentence of this paragraph, this Agreement shall thereupon be deemed amended to include any such services not previously provided for under this Agreement. Upon expiration of the term of such other agreement for interconnection arrangement, resale of Telecommunications Services, or category of Network Elements, the provision thus adopted shall cease to apply and shall revert to the corresponding provision of this Agreement, for all services provided for under this Agreement prior to MCI's exercising this option, or in the case of all other services shall continue to be provided to MCI at the rate agreed by the Parties.

19.2 Notwithstanding the above, the MFN Obligations shall not apply to any service as to which Sprint has established before the Commission, or otherwise established to the reasonable satisfaction of MCI, that:

19.2.1 The costs of providing the interconnection arrangement, resale of Telecommunications Services, or category of Network Elements to MCI are greater than the costs of providing same to the Telecommunications Carrier that originally negotiated such agreement;

19.2.2 The provision of a particular interconnection arrangement, resale of Telecommunications Services, or category of Network Elements to MCI is not technically feasible;

19.2.3 Pricing is provided to a third party for a cost-based term or cost-based volume discount offering and MCI seeks to adopt the cost-based term or cost-based volume discount price without agreeing to all or substantially all of the terms and conditions of the cost-based term or cost-based volume discount offering;

19.2.4 Pricing is provided to a third party on a dissimilar (e.g., deaveraged vs. averaged price) basis, MCI may only elect to amend this Agreement to reflect all such differing pricing (but not

less than all) by category of Network Element or resale of Telecommunications Services in its entirety, contained in such third party agreement; or

19.2.5 Interconnection arrangement, resale of Telecommunications Services, or Network Elements are provided to a third party in conjunction with material terms or conditions related to functionality that directly impact the provisioning of said service and MCIIm seeks to adopt such interconnection arrangement, resale of Telecommunications Services, or Network Elements without inclusion of all or substantially of all said material terms or conditions.

19.2.6 The Parties acknowledge Sprint's intentions to seek changes to Section I of the Interconnection Agreement between MFS Communications Company, Inc. ("MFS") and Sprint-Florida, Incorporated f/k/a United Telephone Company of Florida, dated as of September 19, 1996, ("MFS Agreement"). Notwithstanding MCIIm's option to elect other terms pursuant to this section 19, the Parties expressly stipulate that in no event shall the terms contained in Section I of Schedule 1.0 of the MFS Agreement be made available to MCIIm prior to January 1, 1998. However, if Sprint ceases or concludes its efforts to obtain the changes, whether through agreement with MFS or regulatory action, or if MFS and Sprint exchange local traffic to which compensation for call termination applies pursuant to the MFS agreement, prior to January 1, 1998 this stipulation becomes inapplicable. In such event, Sprint must notify MCIIm within five business days, and such stipulation shall terminate.

## ***Section 20. Termination***

20.1 In the event of breach of any material provision of this Agreement by either Party, the non-breaching Party shall give the other Party written notice thereof, and:

20.1.1 If such material breach is for non-payment of amounts due hereunder pursuant to Attachment VIII, Section 3.1.18 ("Bill Reconciliation"), the breaching Party shall cure such breach within forty-five (45) days of receiving such notice and if it does not, the non-breaching Party may, at its sole option, terminate this Agreement, or any parts hereof, and shall be entitled to pursue all available legal and equitable remedies for such breach. Amounts disputed in good faith and withheld or set off shall not be deemed "amounts due hereunder" for the purpose of this provision.

20.1.2 If such material breach is for any failure to perform in accordance with this Agreement, which, in the sole judgment of the non-breaching Party, adversely affects the non-breaching Party's subscribers, the non-breaching Party shall give notice of the breach and the breaching Party shall cure such breach to the non-breaching Party's reasonable satisfaction within ten (10) days or within a period of time equivalent to the applicable interval required by this Agreement, whichever is shorter, and if the breaching Party does not, the non-breaching Party may, at its sole option, terminate this Agreement, or any parts hereof. The non-breaching Party shall be entitled to pursue all available legal and equitable remedies for such breach. Notice under this Subsection 20.1.2 may be given electronically or by facsimile and in such case shall be deemed received when sent.

20.1.3 If such material breach is for any other failure to perform in accordance with this Agreement, the breaching Party shall cure such breach to the non-breaching Party's reasonable satisfaction within forty-five (45) days, and if it does not, the non-breaching Party may, at its sole option terminate this Agreement, or any parts hereof. The non-breaching Party shall be entitled to pursue all available legal and equitable remedies for such breach.

20.2 MCIIm may terminate this Agreement in whole or in part at any time for any reason upon sixty (60) days prior written notice, except with respect to termination of any particular service(s), in which case, upon thirty (30) days prior written notice. MCIIm's sole liability shall be payment of amounts due for services provided up to the date of termination.

20.3 In the event of any termination under this Section 20, Sprint agrees to provide for an uninterrupted transition of services to MCIIm or another vendor designated by MCIIm. Such transition period shall not exceed three (3) months in length unless it is technically infeasible, in which case the Parties will negotiate in good faith an extension thereof, and MCIIm agrees to continue to pay for any and all services it uses during such transition period.

20.4 Notwithstanding any termination hereof, the Parties shall continue to comply with their obligations under the Act to provide interconnection.

## ***Section 21. Confidentiality and Publicity***

21.1 All confidential or proprietary information disclosed by either Party during the negotiations and the term of this Agreement shall be protected by the Parties in accordance with the terms of this Section 21. All

information which is disclosed by one Party ("Discloser") to the other ("Recipient") in connection with this Agreement, or acquired in the course of performance of this Agreement, shall be deemed confidential and proprietary to the Discloser and subject to this Agreement, such information including but not limited to, orders for services, usage information in any form, and Customer Proprietary Network Information ("CPNI") as that term is defined by the Act and the Rules and Regulations of the FCC ("Confidential and/or Proprietary Information").

21.1.1 For a period of five (5) years from receipt of Confidential Information, Recipient shall: (i) use it only for the purpose of performing under this Agreement; (ii) hold it in confidence and disclose it only to employees who have a need to know it in order to perform under this Agreement; and (iii) safeguard it from unauthorized use or disclosure using no less than the degree of care with which Recipient safeguards its own Confidential Information. Recipient must obtain written authorization from Discloser before disclosing Confidential Information to any third party agent or consultant, and such third party must have executed a written agreement comparable in scope to the terms of this Section 21.

21.1.2 Recipient shall have no obligation to safeguard Confidential Information: (i) which was in the Recipient's possession free of restriction prior to its receipt from the Discloser; (ii) which becomes publicly known or available through no breach of this Agreement by Recipient; (iii) which is rightfully acquired by Recipient free of restrictions on its disclosure; or (iv) which is independently developed by the personnel of Recipient to whom the Discloser's Confidential Information had not been previously disclosed. Recipient may disclose Confidential Information if required, by law, a court, or governmental agency, provided that Discloser has been notified of the requirement promptly after Recipient becomes aware of the requirement, and provided that Recipient undertakes all lawful measures to avoid disclosing such information until Discloser has had reasonable time to obtain a protective order. Recipient agrees to comply with any protective order that covers the Confidential Information to be disclosed.

21.1.3 Each Party agrees that the Discloser would be irreparably injured by a breach of this Section 21 by Recipient or its representatives and that the Discloser shall be entitled to seek equitable relief, including injunctive relief and specific performance, in the event of any breach of this Section 21. Such remedies shall



not be exclusive, but shall be in addition to all other remedies available at law or in equity.

21.2 CPNI related to MCI's subscribers obtained by virtue of Local Interconnection or any other service provided under this Agreement shall be MCI's Proprietary Information and may not be used by Sprint for any purpose except performance of its obligations under this Agreement, and in connection with such performance, shall be disclosed only to employees with a need to know, unless the MCI subscriber expressly directs MCI to disclose such information to Sprint pursuant to the requirements of Section 222(c)(2) of the Act. If Sprint seeks and obtains written approval to use or disclose such CPNI from MCI's subscribers, such approval shall be obtained only in compliance with Section 222(c)(2) of the Act and, in the event such authorization is obtained, Sprint may use or disclose only such information as MCI provides pursuant to such authorization and may not use information that Sprint has otherwise obtained, directly or indirectly, in connection with its performance under this Agreement. CPNI related to Sprint's subscribers obtained by virtue of Local Interconnection shall be Sprint's Proprietary Information and may not be used by MCI for any purpose except performance of its obligations under this Agreement, and in connection with such performance shall be disclosed only to employees with a need to know, unless the Sprint subscriber expressly directs Sprint to disclose such information to MCI pursuant to the requirements of Section 222(c)(2) of the Act. If MCI seeks and obtains written approval to use or disclose such CPNI from Sprint's subscribers, such approval shall be obtained only in compliance with Section 222(c)(2) of the Act and, in the event such authorization is obtained, MCI may use or disclose only such information as Sprint provides pursuant to such authorization and may not use information that MCI has otherwise obtained, directly or indirectly, in connection with its performance under this Agreement.

21.3 Unless otherwise mutually agreed upon, neither Party shall publish or use the other Party's logo, trademark, service mark, name, language, pictures, or symbols or words from which the other Party's name may reasonably be inferred or implied in any product, service, advertisement, promotion, or any other publicity matter, except that nothing in this paragraph shall prohibit a Party from engaging in valid comparative advertising. This paragraph 21.3 shall confer no rights on a Party to the service marks, trademarks and trade names owned or used in connection with services by the other Party or its Affiliates, except as expressly permitted by the other Party.

21.4 Neither Party shall produce, publish, or distribute any press release or other publicity referring to the other Party or its Affiliates, or to this

Agreement, without the prior written approval of the other Party. Each Party shall obtain the other Party's prior approval before discussing this Agreement in any press or media interviews. In no event shall either Party mischaracterize the contents of this Agreement in any public statement or in any representation to a governmental entity or member thereof.

21.5 Except as otherwise expressly provided in this Section 21, nothing herein shall be construed as limiting the rights of either Party with respect to its customer information under any applicable law including, without limitation, Section 222 of the Act.

## **Section 22. Audits and Examinations**

22.1 As used herein "Audit" shall mean a comprehensive review of services performed under this Agreement. "Examination" shall mean an inquiry into a specific element of or process related to services performed under this Agreement. The auditing Party may perform up to two (2) Audits per twelve (12) month period commencing with the Effective Date. The auditing Party may perform Examinations as the auditing Party deems necessary. Audits must be separated by no less than five (5) months.

22.2 Upon thirty (30) days written notice by the auditing Party to the audited Party, the auditing Party shall have the right through its authorized representative to make an Audit or Examination, during normal business hours, of any records, accounts and processes which contain information bearing upon the provision of the services provided and performance standards agreed to under this Agreement. Within the above-described thirty (30) day period, the Parties shall reasonably agree upon the scope of the Audit or Examination, the documents and processes to be reviewed, and the time, place and manner in which the Audit or Examination shall be performed. The audited Party agrees to provide Audit or Examination support, including appropriate access to and use of audited Party's facilities (e.g., conference rooms, telephones, and copying machines).

22.3 Each Party shall bear its own expenses in connection with the conduct of the Audit or Examination. The reasonable cost of special data extractions required by the auditing Party to conduct the Audit or Examination will be paid for by the auditing Party. For purposes of this Section 22.3, a "Special Data Extraction" shall mean the creation of an output record or informational report (from existing data files) that is not created in the normal course of business. If any program is developed to the auditing Party's specifications and at the auditing Party's expense, the

auditing Party shall specify at the time of request whether the program is to be retained by the audited Party for reuse for any subsequent auditing Party Audit or Examination.

22.4 Adjustments, credits or payments shall be made and any corrective action shall commence within thirty (30) days from the auditing Party's receipt of the final audit report to compensate for any errors or omissions which are disclosed by such Audit or Examination and are agreed to by the Parties. The Party responsible for the error shall either forgo interest if they underbilled the other Party, or pay interest if they were responsible for the other Party's underbilling.

22.5 Neither such right to Examine and Audit nor the right to receive an adjustment shall be affected by any statement to the contrary appearing on checks or otherwise, unless such statement expressly waiving such right appears in writing, is signed by the authorized representative of the Party having such right and is delivered to the other Party in a manner sanctioned by this Agreement.

22.6 This Section 22 shall survive expiration or termination of this Agreement for a period of two (2) years after the expiration or termination of this Agreement.

22.7 The rights set forth in this Section 22 are in addition to the audit rights of either Party available under Attachment III, Sections 13.4.1 and 13.4.2.15; Attachment IV, Section 8.2; and Attachment VIII, Section 4.1.1.13.

### ***Section 23. Dispute Resolution Procedures***

The Parties recognize and agree that the Commission has continuing jurisdiction to implement and enforce all terms and conditions of this Agreement. Accordingly, the Parties agree that any dispute arising out of or relating to this Agreement that the Parties themselves cannot resolve, may be submitted to the Commission for resolution. The Parties agree to seek expedited resolution by the Commission, and shall request that resolution occur in no event later than sixty (60) days from the date of submission of such dispute. If the Commission appoints an expert(s) or other facilitator(s) to assist in its decision-making, each Party shall pay one-half of the fees and expenses so incurred. During the Commission proceeding, each Party shall continue to perform its obligations under this Agreement; provided, however that neither Party shall be required to act in any unlawful fashion. This provision shall not preclude the Parties from seeking relief available in any other forum.

### ***Section 24. Bona Fide Request Process for Further Unbundling***

24.1 MCIIm may at any time request, and Sprint shall promptly consider and analyze, access to a new unbundled Network Element described in a Network Element Bona Fide Request ("BFR") hereunder. The Network Element BFR process set forth herein does not apply to those services requested pursuant to Report & Order and Notice of Proposed Rulemaking 91-141 (rel. Oct 19, 1992) paragraph 259 and n.603.

24.2 A Network Element BFR shall be submitted in writing to an address provided by Sprint and shall include a technical description of each requested Network Element.

24.3 MCIIm may cancel a Network Element BFR at any time, but shall pay Sprint's reasonable and demonstrable costs of processing and/or implementing the Network Element BFR up to the date of cancellation.

24.4 Sprint shall make commercially reasonable efforts to acknowledge receipt of the Network Element BFR within three (3) calendar days of receipt, but in no event later than ten (10) calendar days of receipt.

24.5 Except under extraordinary circumstances, within thirty (30) calendar days of its receipt of a Network Element BFR, Sprint shall provide to MCIIm a preliminary analysis of such Network Element BFR. The preliminary analysis shall confirm that Sprint will offer access to the Network Element or will provide a detailed explanation that access to the Network Element is not technically feasible and/or that the request does not qualify as a Network Element that is required to be provided under the Act.

24.6 Upon receipt of the preliminary analysis, MCIIm shall notify Sprint of its intent to proceed or not to proceed within thirty (30) calendar days.

24.7 Sprint shall promptly proceed with the Network Element BFR upon receipt of written authorization from MCIIm. When it receives such authorization, Sprint shall promptly develop the requested services, determine their availability, calculate the applicable prices and establish installation intervals.

24.8 As soon as feasible, but not more than ninety (90) calendar days after its receipt of authorization to proceed with developing the Network Element BFR, Sprint shall provide to MCIIm a Network Element BFR quote which will include, at a minimum, a description of each Network Element, the availability, the applicable rates (developed in accordance with Commission or FCC-approved pricing methodologies) and the installation intervals.

24.9 Within thirty (30) calendar days of its receipt of the Network Element BFR quote, MCIIm must either confirm its order for the Network Element BFR pursuant to the Network Element BFR quote.

24.10 If a Party to a Network Element BFR believes that the other Party is not requesting, negotiating or processing the Network Element BFR in good faith, or disputes a determination, or price or cost quote, such Party may seek mediation or arbitration by the Commission pursuant to Section 252 of the Act, or may invoke the dispute resolution provisions of this Agreement.

### ***Section 25. Branding***

25.1 In all cases in which Sprint has control over handling of Operator and Directory Assistance Services MCIIm may provide using services provided by Sprint under this Agreement, Sprint shall, where technically feasible, at MCIIm's sole discretion and expense, brand any and all such services at all points of customer contact exclusively as MCIIm services, or otherwise as MCIIm may specify, or be provided with no brand at all, as MCIIm shall determine. Sprint shall provide, for MCIIm's review and approval, the methods and procedures, training and approaches to be used by Sprint to assure that Sprint meets MCIIm's branding requirements for such Operator and Directory Assistance Services. Sprint may not unreasonably interfere with branding by MCIIm; provided, that if there are technical limitations as to the number of ILECs that Sprint can brand for, branding will be made available to MCIIm hereunder on a first come, first serve basis.

25.2 MCIIm shall provide the exclusive interface to MCIIm subscribers, except as MCIIm shall otherwise specify. In those instances where MCIIm requires Sprint personnel to interface with MCIIm subscribers, such Sprint personnel shall inform the MCIIm subscribers that they are representing MCIIm, or such brand as MCIIm may specify.

25.3 All forms, business cards or other business materials furnished by Sprint to MCIIm subscribers shall bear no corporate name, logo, trademark or tradename, except that should MCIIm so desire, Sprint will affix upon each such form or other business materials in the position specified by MCIIm a sticker supplied by MCIIm branding such form as MCIIm's or such other brand as MCIIm shall determine.

25.4 Except as specifically permitted by MCIIm, in no event shall Sprint provide information to MCIIm subscribers about MCIIm or MCIIm's products or services.

25.5 This Section 25 shall confer on Sprint no rights to the service marks, trademarks and trade names owned by or used in connection with services by MCIIm or its Affiliates, except as expressly permitted by MCIIm.

### ***Section 26. Taxes***

Any Federal, state or local excise, sales, use or other taxes or tax-like charges (excluding any taxes levied on income) resulting from the performance of this Agreement shall be borne by the Party upon which the obligation for payment is imposed under applicable law, even if the obligation to collect and remit such taxes is placed upon the other Party. Any such taxes shall be shown as separate items on applicable billing documents between the Parties. The Party obligated to collect and remit taxes shall do so unless the other Party provides such Party with the required evidence of exemption. The Party so obligated to pay any such taxes may contest the same in good faith, at its own expense, and shall be entitled to the benefit of any refund or recovery, provided that such party shall not permit any lien to exist on any asset of the other Party by reason of the contest. The Party obligated to collect and remit taxes shall cooperate fully in any such contest by the other Party by providing records, testimony and such additional information or assistance as may reasonably be necessary to pursue the contest.

### ***Section 27. Responsibility for Environmental Contamination***

27.1 MCIIm shall in no event be liable to Sprint for any costs whatsoever resulting from the presence or release of any Environmental Hazard that MCIIm did not introduce to the affected work location. Sprint shall notify MCIIm of any known presence of any Environmental Hazard at any work location. Sprint hereby releases, and shall also indemnify, defend (at MCIIm's request) and hold harmless MCIIm and each of MCIIm's officers, directors and employees from and against any losses and expenses that arise out of or result from: (i) any Environmental Hazard that Sprint, its contractors or its agents introduce to the work locations; or (ii) any other presence or release of any Environmental Hazard at any work location, except as provided in Section 27.2 of this Part A; provided that in the event that prior to MCIIm or its employees, contractors or agents entering a work location Sprint fully informs MCIIm in writing of an Environmental Hazard at such work location and Sprint complies with all obligations it has with respect thereto, then Sprint shall not be obligated to indemnify MCIIm for losses and expenses arising out of injuries to MCIIm employees, contractors or agents resulting from their exposure to such Environmental Hazard, except to the extent such injuries are the result of, in whole or part, the acts of any Sprint employee, contractor or agent.

27.2 Prior to MCIIm or its employees, contractors, or agents introducing an Environmental Hazard into a work location, MCIIm shall inform Sprint in

writing of its planned actions at such work location and MCIIm warrants that it shall comply with all legal and regulatory obligations it has with respect to such Environmental Hazard and notices it is required to provide with respect thereto. Sprint shall in no event be liable to MCIIm for any costs whatsoever resulting from the presence or release of any Environmental Hazard that MCIIm introduces to the affected work location. MCIIm shall indemnify, defend (at Sprint's request) and hold harmless Sprint and each of Sprint's officers, directors and employees from and against any losses and expenses that arise out of or result from any Environmental Hazard that MCIIm, its contractors or its agents introduce to the work location, unless such losses and expenses arise out or result from the negligent acts of any Sprint employee, contractor or agent.

27.3 In the event any suspect materials within Sprint-owned, operated or leased facilities are identified to be asbestos-containing, MCIIm will ensure that to the extent any activities which it undertakes in the facility disturb such suspect materials, such MCIIm activities will be in accordance with applicable local, state and federal environmental and health and safety statutes and regulations. Except for abatement activities undertaken by MCIIm or equipment placement activities that result in the generation of asbestos-containing material, MCIIm shall not have any responsibility for managing, nor be the owner of, nor have any liability for or in connection with, any asbestos containing material. Sprint agrees to immediately notify MCIIm if Sprint undertakes any asbestos control or asbestos abatement activities that potentially could affect MCIIm equipment or operations including, but not limited to, contamination of equipment.

27.4 Within five (5) business days of MCIIm's request for any IP or space, Sprint shall provide any information in its possession or available to it regarding the environmental conditions of the IP route or location or the space provided for placement of equipment and interconnection including, but not limited to, the existence and condition of asbestos, lead paint, hazardous substance contamination, or radon. Information is considered "available" under this Agreement if it is in Sprint's possession, or the possession of a current agent, contractor, or employee of Sprint's. The Parties shall cooperate to obtain any such information regarding environmental conditions from any lessor or tenant of Sprint in any case such information is requested by MCIIm.

27.5 If the space provided for the placement of equipment, interconnection, or provision of service contains environmental contamination or hazardous material particularly, but not limited to, asbestos, lead paint or radon, which makes the placement of such equipment or interconnection hazardous, Sprint shall offer an alternative space, if available, for MCIIm's consideration. If interconnection is

complicated by the presence of environmental contamination or hazardous materials, and an alternative route is available, Sprint shall make such alternative route available for MCI's consideration.

27.6 Subject to Sprint's standard security procedures, which procedures will be provided to MCI, Sprint shall allow MCI at MCI's expense to perform any environmental site investigations including, but not limited to, asbestos surveys, which MCI deems to be necessary in support of its Collocation needs.

***Section 28. Amendments and Modifications***

No provision of this Agreement shall be deemed waived, amended or modified by either Party unless such a waiver, amendment or modification is in writing, dated, and signed by both Parties.

***Section 29. Severability***

Subject to Section 2 (Regulatory Approvals), if any part of this Agreement is held to be invalid for any reason, such invalidity will affect only the portion of this Agreement which is invalid. In all other respects this Agreement will stand as if such invalid provision had not been a part thereof, and the remainder of the Agreement shall remain in full force and effect.

***Section 30. Headings Not Controlling***

The headings and numbering of Sections, Parts and Attachments in this Agreement are for convenience only and shall not be construed to define or limit any of the terms herein or affect the meaning or interpretation of this Agreement.

***Section 31. Entire Agreement***

This Agreement, including all Parts and Attachments and subordinate documents attached hereto or referenced herein, all of which are hereby incorporated by reference herein, constitute the entire matter thereof, and supersede all prior oral or written agreements, representations, statements, negotiations, understandings, proposals, and undertakings with respect to the subject matter thereof. This Agreement shall expressly supersede the Interconnection and Compensation Agreement between MCI and United Telephone Company of Florida effective September 26, 1996.

***Section 32. Counterparts***

This Agreement may be executed in counterparts. Each counterpart shall be considered an original and such counterparts shall together constitute one and the same instrument.



**Section 33. Successors and Assigns**

This Agreement shall be binding upon, and inure to the benefit of, the Parties hereto and their respective successors and permitted assigns.

**Section 34 Implementation Team and Implementation Plan**

**34.1 Implementation Team.** This Agreement sets forth the overall standards of performance for the services, processes, and systems capabilities that the Parties will provide to each other, and the intervals at which those services, processes and capabilities will be provided. The Parties understand that the arrangements and provision of services described in this Agreement shall require technical and operational coordination between the Parties. Accordingly, the Parties agree to form a team (the "Implementation Team") which shall develop and identify those processes, guidelines, specifications, standards and additional terms and conditions necessary to support and satisfy the standards set forth in this Agreement and implement each Party's obligations hereunder. Within five (5) days after the Effective Date, each Party shall designate, in writing, not more than four (4) persons to be permanent members of the Implementation Team; provided that either Party may include in meetings or activities such technical specialists or other individuals as may be reasonably required to address a specific task, matter or subject. Each Party may replace its representatives on the Implementation Team by delivering written notice thereof to the other Party. Each Party represents and warrants that its representatives on the Implementation Team shall have authority to make decisions on behalf of such Party and bind such Party.

**34.2 Implementation Plan.** Within ninety (90) days after the date on which the Commission (or the FCC if the Commission fails to act)<sup>1</sup> approves this Agreement under Section 252 of the Act, the agreements reached by the Implementation Team shall be documented in an operations manual (the "Implementation Plan"). The Implementation Plan shall address the following matters, and may include any other matters agreed upon by the Implementation Team:

(1) the respective duties and responsibilities of the Parties with respect to the administration and maintenance of the Interconnections (including signaling) specified in Attachment IV and the trunk groups specified in Attachment IV and, including standards and procedures for notification and discoveries of trunk disconnects;

(2) disaster recovery and escalation provisions;

PART B

"GATEWAY" ("ALI GATEWAY") is a telephone company computer facility that interfaces with MCI's 911 administrative site to receive Automatic Location Identification ("ALI") data from MCI. Access to the Gateway will be via a dial-up modem using a common protocol.

"GRANDFATHERED SERVICE" means service which is no longer available for new customers and are limited to the current customer at their current locations with certain provisioning limitations including, but not limited to, upgrade denials, feature adds/changes and responsible/billing party.

"INCUMBENT LOCAL EXCHANGE CARRIER" ("ILEC") means the incumbent local exchange carrier.

"INTERCONNECTION POINT" ("IP") is a mutually agreed upon point of demarcation where the networks of Sprint and MCI interconnect for the exchange of traffic.

"INTEREXCHANGE CARRIER" ("IXC") means a provider of interexchange Telecommunications Services.

"INTERIM NUMBER PORTABILITY" ("INP") is a service arrangement whereby subscribers who change local service providers may retain existing telephone numbers without impairment of quality, reliability, or convenience when remaining at their current location or changing their location within the geographic area served by the initial carrier's serving Central Office.

"LINE INFORMATION DATABASE(S)" ("LIDB") (is a "SERVICE CONTROL POINT" ("SCP") database that provides for such functions as calling card validation for telephone line number cards issued by Sprint and other entities and validation for collect and billed-to-third services.

"LOCAL TRAFFIC" means traffic that is originated and terminated within a given local calling area, or Expanded Area Service ("EAS") area, as defined by state Commissions or, if not defined by State Commissions, then as defined in existing Sprint tariffs.

"MASTER STREET ADDRESS GUIDE" ("MSAG") is a database defining the geographic area of an E911 service. It includes an alphabetical list of the street names, high-low house number ranges, community names, and emergency service numbers provided by the counties or their agents to Sprint.

"MCI" means MCI TELECOMMUNICATION CORPORATION.

"MCI" means MCImetro ACCESS TRANSMISSION SERVICES, INC.

"NATIONAL EMERGENCY NUMBER ASSOCIATION" ("NENA") is an association with a mission to foster the technological advancement, availability and implementation of 911 nationwide.

"NETWORK ELEMENT" means a facility or equipment used in the provision of a Telecommunications Service. Such term also includes features, functions, and capabilities that are provided by means of such facility or equipment, including subscriber numbers, databases, signaling systems, and information sufficient for billing and collection or used in the transmission, routing, or other provision of a Telecommunications Service.

"NUMBER PORTABILITY" ("NP") means the ability of users of Telecommunications Services to retain, at the same location, existing telecommunications numbers without impairment of quality, reliability, or convenience when switching from one telecommunications carrier to another.

"NUMBERING PLAN AREA" ("NPA") (sometimes referred to as an area code). Is the three (3) digit indicator which is designated by the first three (3) digits of each ten (10) digit telephone number within the NANP. Each NPA contains eight-hundred (800) possible NXX Codes. There are two general categories of NPA – "Geographic NPAs" and "Non-Geographic NPAs." A Geographic NPA is associated with a defined geographic area, and all telephone numbers bearing such NPA are associated with services provided within that geographic area. A Non-Geographic NPA, also known as a Service Access Code ("SAC Code") is typically associated with a specialized telecommunications service which may be provided across multiple geographic NPA areas. 500, 800, 900, 700, and 888 are examples of Non-Geographic NPAs.

"NXX," "NXX CODE," or "CENTRAL OFFICE CODE," or "CO CODE" is the three (3) digit switch entity indicator which is defined by the fourth, fifth and sixth digits of a ten (10) digit telephone number within the NANP.

"OPERATOR SERVICES" provides: (1) operator handling for call completion (e.g., collect calls); (2) operator or automated assistance for billing after the subscriber has dialed the called number (e.g., credit card calls); and (3) special services (e.g., BLV/ELI, Emergency Agency Call).

"OPERATOR SYSTEMS" is the Network Element that provides operator and automated call handling with billing, special services, subscriber telephone listings, and optional call completion services.

"ORDERING AND BILLING FORUM" ("OBF") functions under the auspices of the Carrier Liaison Committee ("CLC") of the Alliance for Telecommunications Industry Solutions ("ATIS").

"P.01 TRANSMISSION GRADE OF SERVICE ("GOS")" means a trunk facility provisioning standard with the statistical probability of no more than one (1) call in one hundred (100) blocked on initial attempt during the average busy hour.

"PARITY" means, subject to the availability, development and implementation of necessary industry standard electronic interfaces, the provision by Sprint of services, Network Elements, functionality or telephone numbering resources under this Agreement to MCI on terms and conditions, including provisioning and repair intervals, no less favorable than those offered to Sprint, its Affiliates or any other entity that obtains such services, Network Elements, functionality or telephone numbering resources. Until the implementation of necessary electronic interfaces, Sprint shall provide such services, Network Elements, functionality or telephone numbering resources on a non-discriminatory basis to MCI as it provides to its Affiliates or any other entity that obtains such services, Network Elements, functionality or telephone numbering resources.

"PARTY" means either Sprint or MCI, and PARTIES means Sprint and MCI.

"PERCENT LOCAL USAGE" ("PLU") is a calculation which represents the ratio of the local minutes to the sum of local and IntraLATA toll minutes between exchange carriers sent over local interconnection trunks. Directory assistance, BLV/BLVI, 900, 976, transiting calls from other exchange carriers and switched access calls are not included in the calculation of PLU.

"POP" means an IXC's point of presence.

"PROPRIETARY INFORMATION" shall have the same meaning as Confidential Information.

"PUBLIC SAFETY ANSWERING POINT" ("PSAP") is the public safety communications center where 911 calls placed by the public for a specific geographic area will be answered.

"RATE CENTER" means the geographic point and corresponding geographic area which are associated with one or more particular NPA-NXX codes which have been assigned to Sprint (or MCI) for its provision of Basic Exchange Telecommunications Services. The "Rate Center Point" is the finite geographic point identified by a specific V&H coordinate, which is used to measure distance-sensitive end user traffic to/from the particular NPA-NXX designations associated with the specific Rate Center. The "Rate Center Area" is the exclusive geographic area identified as the area within which Sprint (or MCI) will provide basic exchange Telecommunications Services bearing the particular NPA-NXX designations associated with the specific Rate Center. The Rate Center point must be located within the Rate Center area.

"REAL TIME" means the actual time in which an event takes place, with the reporting on or the recording of the event simultaneous with its occurrence.

"RECIPIENT" means that Party to this Agreement: (a) to which Confidential Information has been disclosed by the other Party, or (b) who has obtained Confidential Information in the course of providing services under this Agreement.

"RESELLER" is a category of local exchange service providers who obtain dial tone and associated Telecommunications Services from another provider for resale to their end user subscribers.

"RIGHT OF WAY" ("ROW") has the meaning set forth in Section 2.13 of Attachment VI of this Agreement.

"SELECTIVE ROUTING" is a service which automatically routes an E911 call to the PSAP that has jurisdictional responsibility for the service address of the telephone that dialed 911, irrespective of telephone company exchange or wire center boundaries.

"SMALL EXCHANGE CARRIER ACCESS BILLING" ("SECAB") means the document prepared by the Billing Committee of the OBF. The Small Exchange Carrier Access Billing document, published by Bellcore as Special Report SR OPT-001856, contains the recommended guidelines for the billing of access and other connectivity services.

"SWITCH" – See Central Office Switch.

"TANDEM OFFICE SWITCHES" are Class 4 switches which are used to connect and switch trunk circuits between and among end office switches and other tandems.

"TECHNICALLY FEASIBLE" refers solely to technical or operational concerns, rather than economic, space, or site considerations.

"TELECOMMUNICATIONS" means the transmission, between or among points specified by the user, of information of the user's choosing, without change in the form or content of the information as sent and received.

"TELECOMMUNICATIONS SERVICES" means the offering of Telecommunications for a fee directly to the public, or to such classes of users as to be effectively available directly to the public, regardless of the facilities used.

"VOLUNTARY FEDERAL SUBSCRIBER FINANCIAL ASSISTANCE PROGRAMS" are government programs that subsidize the provision of Telecommunications

Services to low-income subscribers, pursuant to requirements established by the appropriate state regulatory body.

"WIRE CENTER" denotes a building or space within a building which serves as an aggregation point on a given carrier's network, where transmission facilities and circuits are connected or switched. Wire Center can also denote a building in which one or more central offices, used for the provision of basic exchange services and Access Services, are located. However, for purposes of EIC service, Wire Center shall mean those points eligible for such connections as specified in the FCC Docket No. 91-141, and rules adopted pursuant thereto.

**TABLE OF CONTENTS**

**Attachment I  
PRICE SCHEDULE**

Section 1.	General Principles	I - 1
Section 2.	Non-Discriminatory Treatment	I - 1
Section 3.	Local Service Resale	I - 1
Section 4.	Interconnection and Reciprocal Compensation	I - 2
Section 5.	Unbundled Network Elements	I - 2

## ATTACHMENT I

### PRICE SCHEDULE

#### ***Section 1. General Principles***

1.1 All rates provided under this Agreement shall remain in effect for the term of this Agreement unless they are not in accordance with all applicable provisions of the Act, the Rules and Regulations of the FCC, or the Commission's orders, rules and regulations, including such Commission order(s) that result from a generic docket relating to Incumbent Local Exchange Carrier ("ILEC") costing/pricing or from a docket relating specifically to Sprint's costing/pricing, in which case Part A, Section 2 shall apply.

1.2 Except as otherwise specified in this Agreement, Sprint shall be responsible for all costs and expenses it incurs in: (i) complying with and implementing its obligations under this Agreement, the Act, and the rules, regulations and orders of the FCC and the Commission; and (ii) the development, modification, technical installation and maintenance of any systems or other infrastructure which it requires to comply with and to continue complying with its responsibilities and obligations under this Agreement; provided, however, that Sprint may impose charges for additional service to be provided under this Agreement by amendment to this Attachment I consistent with this Agreement.

#### ***Section 2. Non-Discriminatory Treatment***

Sprint shall offer rates to MCI in a non-discriminatory manner in accordance with Part A, Sections 2.4, 13 and 19.

#### ***Section 3. Local Service Resale***

3.1 The rates that MCI shall pay to Sprint for Local Resale shall be an amount equal to Sprint's retail tariffed rates for each noted element as reduced by a percentage amount equal to the Base Line Resale Discount (defined below). If Sprint changes such tariffed rates during the term of this Agreement, the Base Line Resale Discount shall be applied to the new tariffed rates.



3.2 **Base Line Resale Discount.** The Base Line Resale Discount is included in Table 1 of this Attachment.

**Section 4. *Interconnection and Reciprocal Compensation***

4.1 The rates to be charged for the exchange of Local Traffic are set forth in Table 1 of this Attachment and shall be applied consistent with the provisions of Attachment IV of this Agreement.

4.2 Compensation for the termination of toll traffic and the origination of 800 traffic between the interconnecting parties shall be based on the applicable access charges in accordance with FCC and Commission Rules and Regulations including but not limited to Order PSC-96-1231-FOF-PP, Docket Number 95-0985-PP, and consistent with the provisions of Attachment IV of this Agreement.

4.3 Where a toll call is completed through Sprint's Interim Number Portability ("INP") arrangement (e.g., remote call forwarding, flexible DID, etc.) to an MCI subscriber, MCI shall be entitled to applicable access charges in accordance with FCC and Commission Rules and Regulations.

4.4 MCI shall pay a transit rate, comprised of the transport and tandem rate elements, as set forth in Table 1 of this Attachment when MCI uses a Sprint access tandem to terminate a local call to a third party Local Exchange Carrier ("LEC") or another Competitive Local Exchange Carrier ("CLEC"). Sprint shall pay MCI a transit rate equal to the Sprint rate referenced above when Sprint uses an MCI Switch to terminate a local call to a third party LEC or another CLEC.

**Section 5. *Unbundled Network Elements***

The charges that MCI shall pay to Sprint for Network Elements are set forth in Table 1 of this Attachment I.

FLORIDA

LOCAL SERVICE RESALE

BASE LINE RESALE DISCOUNT

CATEGORY 1	CATEGORY 2
All Services Except Operator Services & Directory Assistance	Operator Services & Directory Assistance
19.4%	12.1%

RATE ELEMENT	SOURCE	RECURRING RATE	NRC
	SPRINT TELRIC COST STUDY		
Service Order NRC			\$25.15
Service Order Listing Only			\$20.82
Central Office Interconnection Charge			\$10.27
Trip Charge			\$18.41
Outside Plant Interconnection (2-W)			\$59.75
Outside Plant Interconnection (4-W)			\$74.72
NID Installation Charge			\$37.36
NID Connection Charge			\$18.68
Testing			\$1.42
Loop Rework Charge (2-W)			\$37.38
Loop Rework Charge (4-W)			\$62.41
Trouble Isolation and Testing			\$66.58
	SPRINT TELRIC COST STUDY		
NID			
1 Line		\$0.79	
2 Line		\$0.95	
Smart Jack		\$12.37	
HDSL		\$24.82	
	SPRINT TELRIC COST STUDY		
LOOP			
Analog 2-wire Band 1		\$15.00 #	
Analog 2-wire Band 2		\$15.00 #	
Analog 2-wire Band 3		\$15.00 #	
Analog 2-wire Band 4		\$15.00 #	
Analog 2-wire Band 5		\$15.00 #	
Analog 2-wire Band 6		\$15.00 #	
Analog 2-wire Band 7		\$15.00 #	
Analog 2-wire Band 8		\$15.00 #	
	SPRINT TELRIC COST STUDY		
LOCAL SWITCHING			
Band 1		\$5.82 #	
Band 2		\$7.72 #	
Band 3		\$8.99 #	
Band 4		\$10.08 #	
Band 5		\$11.66 #	
Band 6		\$13.83 #	
Interstate CCL Orig *	Interstate Access Tariff	\$0.010000	
Interstate CCL Term *		\$0.015561	

RATE ELEMENT	SOURCE	RECURRING RATE	NRC
RIC *		\$0.005213	
Intrastate CCL Orig *	Intrastate Access Tariff	\$0.025800	
Intrastate CCL Term *		\$0.033600	
RIC *		\$0.010824	
<b>SPRINT TELRIC COST STUDY</b>			
<b>LOOP &amp; PORT COMB. DISCOUNT</b> (1 Line NID, 2 Wire Loop, & Basic Port)		\$ #	
<b>SPRINT TELRIC COST STUDY</b>			
<b>FEATURES</b>			
CCF Package *		\$ #	\$ #
CLASS Package *		\$ #	\$ #
CENTREX Package *		\$ #	\$ #
- 3-Way Conf/Consult/Hold Transfer		\$ #	\$ #
- Conf Calling - 6 Way Station Control		\$ #	\$ #
- Dial Transfer to Tandem Tie Line		\$ #	\$ #
- Direct Connect		\$ #	\$ #
- Meet-Me Conference		\$ #	\$ #
- Multi-Hunt Service		\$ #	\$ #
<b>INTERIM NUMBER PORTABILITY</b>	* will be determined in Florida Docket 950737 TP		
RCF Residential		\$0.00 *	\$0.00 *
RCF Business		\$0.00 *	\$0.00 *
Call Path Residential		\$0.00 *	\$0.00 *
Call Path Business		\$0.00 *	\$0.00 *
<b>SPRINT TELRIC COST STUDY</b>			
<b>TANDEM SWITCHING</b>		\$0.002750	
<b>TRANSPORT</b>	Interstate Access Tariff	Fixed # Per Mile #	
Voice Grade		\$60.00 \$2.40 #	\$144.00
DS1 Zone 1		\$79.00 \$17.00 #	\$222.95
DS1 Zone 2		\$93.00 \$20.00 #	\$222.95
DS1 Zone 3		\$98.00 \$21.00 #	\$222.95
DS3 Zone 1		\$468.00 \$168.00 #	\$249.16
DS3 Zone 2		\$550.00 \$198.00 #	\$249.16
DS3 Zone 3		\$578.00 \$208.00 #	\$249.16
Common Zone 1		\$0.000255 #	\$226.50

MCImetro - Sprint  
Florida Agreement

NETWORK ELEMENT PRICE LIST - SPRINT FLORIDA  
DOCKET # 961230 - TP  
(03/14/97)

RATE ELEMENT	SOURCE	RECURRING RATE	NRC
Common Zone 2		\$0.000255 #	\$226.50
Common Zone 3		\$0.000255 #	\$226.50
<b>RECIPROCAL COMPENSATION</b>	<b>SPRINT TELRIC COST STUDY</b>	<b>Per MOU</b>	
End Office Band 1		\$0.002081	\$119.76
End Office Band 2		\$0.002983	\$119.76
End Office Band 3		\$0.003471	\$119.76
End Office Band 4		\$0.004286	\$119.76
End Office Band 5		\$0.005073	\$119.76
End Office Band 6		\$0.006313	\$119.76
End Office Band 7		\$0.007766	\$119.76
<b>Tandem Switching</b>	<b>SPRINT TELRIC COST STUDY</b>	<b>\$0.002750</b>	
<b>Transport</b>	<b>Interstate Access Tariff</b>	<b>Fixed # Per Mile #</b>	
Voice Grade		\$60.00 \$2.40 #	\$144.00
DS1 Zone 1		\$79.00 \$17.00 #	\$222.95
DS1 Zone 2		\$93.00 \$20.00 #	\$222.95
DS1 Zone 3		\$98.00 \$21.00 #	\$222.95
DS3 Zone 1		\$468.00 \$168.00 #	\$249.16
DS3 Zone 2		\$550.00 \$198.00 #	\$249.16
DS3 Zone 3		\$578.00 \$208.00 #	\$249.16
Common Zone 1		\$0.000255 #	\$226.50
Common Zone 2		\$0.000255 #	\$226.50
Common Zone 3		\$0.000255 #	\$226.50
<b>INTERCONNECTION</b>	<b>SPRINT TELRIC COST STUDY</b>		
<b>CROSS CONNECTION</b>			
DS0 Elec X-Conn		\$0.84	
DS1 Elec X-Conn		\$2.64	
DS3 Elec X-Conn		\$23.23	
Other collocation elements (both physical or virtual) will mirror the Florida Intrastate tariff rates during the interim period until the commission establishes permanent cost based rates.			
<b>COMMON CHANNEL SIGNALING INTERCONNECTION SERVICE</b>			
STP Port	SPRINT TELRIC COST STUDY	\$498.97 #	\$308.00

(03/14/97)

RATE ELEMENT	SOURCE	RECURRING RATE	NRC
STP Switching	SPRINT TELRIC COST STUDY	\$1.08 #	
56.0 Kbps SS7 Link Fixed	Interstate Access Tariff	\$82.00 #	\$211.18
56.0 Kbps SS7 Link Per Mile	Interstate Access Tariff	\$4.80 #	
1.544 MBPS SS7 Link Fixed	Interstate Access Tariff	\$93.00 #	
1.544 MBPS SS7 Link Per Mile	Interstate Access Tariff	\$20.00 #	
Multiplexing DS1 to DS0	Interstate Access Tariff	\$318.00 #	\$142.00
Service Control Points		\$0.00119 #	
<b>LINE INFORMATION DATABASE</b>			
LIDB Administration Service	SPRINT TELRIC COST STUDY	\$0.0489	
LIDB Database Transport per query	Interstate Access Tariff	\$0.0016 #	
LIDB Database per query	Interstate Access Tariff	\$0.0366 #	
Toll Free Code Access Service query	Interstate Access Tariff	\$0.008498 #	
Toll Free Code Optional Service query	Interstate Access Tariff	\$0.001491 #	
<b>DIRECTORY ASSISTANCE SERVICES</b>			
DA Database Listing & Update Service	SPRINT TELRIC COST STUDY	\$0.048	
DA Data Base Query Service	SPRINT TELRIC COST STUDY	\$0.0215 #	
<b>TOLL &amp; LOCAL OPERATOR SERVICES</b>			
Toll and Local Assistance Service (Live)		\$0.389 #	
<b>DA OPERATOR SERVICES</b>			
DA Operator Service (Live)		\$0.339 #	
<b>911 TANDEM PORT</b>			
Per DS0 Equivalent Port	SPRINT TELRIC Cost Study Attachment I. Q	\$17.02	\$187.59

MCImetro - Sprint  
Florida Agreement

Sprint - Florida  
2-Wire Local Loops  
Docket # 961230 - TP  
(03/14/97)

Exchange	Interim Rate
ALFORD, FL	\$15.00
ALTAMONTE SPRINGS, FL	\$15.00
APOPKA, FL	\$15.00
ARCADIA, FL	\$15.00
ASTOR, FL	\$15.00
AVON PARK, FL	\$15.00
BAKER, FL	\$15.00
BELLEVIEW, FL	\$15.00
BEVERLY HILLS, FL	\$15.00
BOCA GRANDE, FL	\$15.00
BONIFAY, FL	\$15.00
BONITA SPRINGS, FL	\$15.00
BOWLING GREEN, FL	\$15.00
BUSHNELL, FL	\$15.00
CAPE CORAL, FL	\$15.00
CAPE HAZE, FL	\$15.00
CASSELBERRY, FL	\$15.00
CHERRY LAKE, FL	\$15.00
CLERMONT, FL	\$15.00
CLEWISTON, FL	\$15.00
COTTONDALE, FL	\$15.00
CRAWFORDVILLE, FL	\$15.00
CRESTVIEW, FL	\$15.00
CRYSTAL RIVER, FL	\$15.00
CYPRESS LAKE, FL	\$15.00
DADE CITY, FL	\$15.00
DEFUNIAK SPRINGS, FL	\$15.00
DESTIN, FL	\$15.00
EUSTIS, FL	\$15.00
EVERGLADES, FL	\$15.00
FOREST, FL	\$15.00
FORT MEADE, FL	\$15.00
FREEPORT, FL	\$15.00
FT MYERS BEACH, FL	\$15.00
FT. MYERS, FL	\$15.00
FT. WALTON BEACH, FL	\$15.00
GLENDALE, FL	\$15.00
GOLDENROD, FL	\$15.00
GREENVILLE, FL	\$15.00
GREENWOOD, FL	\$15.00
GROVELAND, FL	\$15.00
HOMOSASSA SPRINGS, FL	\$15.00
HOWEY-IN-THE-HILLS, FL	\$15.00
IMMOKALEE, FL	\$15.00
INVERNESS, FL	\$15.00
KENANSVILLE, FL	\$15.00

MCImetro - Sprint  
Florida Agreement

Sprint - Florida  
2-Wire Local Loops  
Docket # 961230 - TP  
(03/14/97)

Exchange	Interim Rate
KINGSLEY LAKE, FL	\$15.00
KISSIMMEE, FL	\$15.00
LABELLE, FL	\$15.00
LADY LAKE, FL	\$15.00
LAKE BRANTLEY, FL	\$15.00
LAKE PLACID, FL	\$15.00
LAWTEY, FL	\$15.00
LEE, FL	\$15.00
LEESBURG, FL	\$15.00
LEHIGH ACRES, FL	\$15.00
MADISON, FL	\$15.00
MAITLAND, FL	\$15.00
MALONE, FL	\$15.00
MARCO ISLAND, FL	\$15.00
MARIANNA, FL	\$15.00
MONTICELLO, FL	\$15.00
MONTVERDE, FL	\$15.00
MOORE HAVEN, FL	\$15.00
MT. DORA, FL	\$15.00
NAPLES MOORINGS, FL	\$15.00
NAPLES, FL	\$15.00
NORTH CAPE CORAL, FL	\$15.00
NORTH FT. MYERS, FL	\$15.00
NORTH NAPLES, FL	\$15.00
OCALA, FL	\$15.00
OKEECHOBEE, FL	\$15.00
OKLAWAHA, FL	\$15.00
ORANGE CITY, FL	\$15.00
PANACEA, FL	\$15.00
PINE ISLAND, FL	\$15.00
PONCE DE LEON, FL	\$15.00
PORT CHARLOTTE, FL	\$15.00
PUNTA GORDA, FL	\$15.00
REEDY CREEK, FL	\$15.00
REYNOLDS HILL, FL	\$15.00
SALT SPRINGS, FL	\$15.00
SAN ANTONIO, FL	\$15.00
SANIBEL ISLAND, FL	\$15.00
SANTA ROSA, FL	\$15.00
SEA GROVE BEACH, FL	\$15.00
SEBRING, FL	\$15.00
SHADY ROAD, FL	\$15.00
SHALIMAR, FL	\$15.00
SILVER SPRINGS SHORES, FL	\$15.00
SNEADS, FL	\$15.00
SOPCHOPPY, FL	\$15.00



MCImetro - Sprint  
Florida Agreement

Sprint - Florida  
2-Wire Local Loops  
Docket # 961230 - TP  
(03/14/97)

Exchange	Interim Rate
SPRING LAKE, FL	\$15.00
ST. CLOUD, FL	\$15.00
ST. MARKS, FL	\$15.00
STARKE, FL	\$15.00
TALLAHASSEE, FL	\$15.00
TAVARES, FL	\$15.00
TRILLACOOCHEE, FL	\$15.00
UMATILLA, FL	\$15.00
VALPRAISO, FL	\$15.00
WAUCHULA, FL	\$15.00
WEST KISSIMMEE, FL	\$15.00
WESTVILLE, FL	\$15.00
WILDWOOD, FL	\$15.00
WILLISTON, FL	\$15.00
WINDERMERE, FL	\$15.00
WINTER GARDEN, FL	\$15.00
WINTER PARK, FL	\$15.00
ZOLFO SPRINGS, FL	\$15.00

MCImetro - Sprint  
Florida Agreement

Sprint - Florida Switching Interconnection Rates  
Docket # 961230 - TP  
(03/14/97)

Exchange	Rate Band	Interim Rate
ALTAMONTE SPRINGS, FL	1	\$0.002081
BONITA SPRINGS, FL	1	\$0.002081
CYPRESS LAKE, FL	1	\$0.002081
FT MYERS BEACH, FL	1	\$0.002081
FT. WALTON BEACH, FL	1	\$0.002081
GOLDENROD, FL	1	\$0.002081
LAKE BRANTLEY, FL	1	\$0.002081
TALLAHASSEE, FL	1	\$0.002081
WINTER PARK, FL	1	\$0.002081
CASSELBERRY, FL	2	\$0.002983
FT. MYERS, FL	2	\$0.002983
OCALA, FL	2	\$0.002983
ORANGE CITY, FL	2	\$0.002983
APOPKA, FL	3	\$0.003471
CHERRY LAKE, FL	3	\$0.003471
CRYSTAL RIVER, FL	3	\$0.003471
DESTIN, FL	3	\$0.003471
EUSTIS, FL	3	\$0.003471
FREEPORT, FL	3	\$0.003471
INVERNESS, FL	3	\$0.003471
KISSIMMEE, FL	3	\$0.003471
LADY LAKE, FL	3	\$0.003471
LEESBURG, FL	3	\$0.003471
MADISON, FL	3	\$0.003471
MARCO ISLAND, FL	3	\$0.003471
MONTICELLO, FL	3	\$0.003471
MT. DORA, FL	3	\$0.003471
NAPLES MOORINGS, FL	3	\$0.003471
NAPLES, FL	3	\$0.003471
NORTH NAPLES, FL	3	\$0.003471
PORT CHARLOTTE, FL	3	\$0.003471
SANTA ROSA, FL	3	\$0.003471
SEA GROVE BEACH, FL	3	\$0.003471
TAVARES, FL	3	\$0.003471
VALPRAISO, FL	3	\$0.003471
WILDWOOD, FL	3	\$0.003471
ALFORD, FL	4	\$0.004286
ARCADIA, FL	4	\$0.004286
ASTOR, FL	4	\$0.004286
BAKER, FL	4	\$0.004286
BELLEVIEW, FL	4	\$0.004286
BONIFAY, FL	4	\$0.004286
BOWLING GREEN, FL	4	\$0.004286

MCImetro - Sprint  
Florida Agreement

Sprint - Florida Switching Interconnection Rates  
Docket # 961230 - TP  
(03/14/97)

Exchange	Rate Band	Interm Rate
COTTONDALE, FL	4	\$0.004286
EVERGLADES, FL	4	\$0.004286
GLENDALE, FL	4	\$0.004286
GREENVILLE, FL	4	\$0.004286
GREENWOOD, FL	4	\$0.004286
HOWEY-IN-THE-HILLS, FL	4	\$0.004286
KENANSVILLE, FL	4	\$0.004286
KINGSLEY LAKE, FL	4	\$0.004286
LAWTEY, FL	4	\$0.004286
LEE, FL	4	\$0.004286
LEHIGH ACRES, FL	4	\$0.004286
MAITLAND, FL	4	\$0.004286
MALONE, FL	4	\$0.004286
MONTVERDE, FL	4	\$0.004286
OKEECHOBEE, FL	4	\$0.004286
OKLAWAHA, FL	4	\$0.004286
PANACEA, FL	4	\$0.004286
PONCE DE LEON, FL	4	\$0.004286
REYNOLDS HILL, FL	4	\$0.004286
SALT SPRINGS, FL	4	\$0.004286
SHADY ROAD, FL	4	\$0.004286
SILVER SPRINGS SHORES, FL	4	\$0.004286
SNEADS, FL	4	\$0.004286
SOPCHOPPY, FL	4	\$0.004286
ST. MARKS, FL	4	\$0.004286
UMATILLA, FL	4	\$0.004286
WEST KISSIMMEE, FL	4	\$0.004286
WESTVILLE, FL	4	\$0.004286
WILLISTON, FL	4	\$0.004286
WINTER GARDEN, FL	4	\$0.004286
AVON PARK, FL	5	\$0.005073
BEVERLY HILLS, FL	5	\$0.005073
BOCA GRANDE, FL	5	\$0.005073
CAPE CORAL, FL	5	\$0.005073
CLERMONT, FL	5	\$0.005073
CRAWFORDVILLE, FL	5	\$0.005073
CRESTVIEW, FL	5	\$0.005073
DADE CITY, FL	5	\$0.005073
FOREST, FL	5	\$0.005073
FORT MEADE, FL	5	\$0.005073
HOMOSASSA SPRINGS, FL	5	\$0.005073
IMMOKALEE, FL	5	\$0.005073
LABELLE, FL	5	\$0.005073
NORTH CAPE CORAL, FL	5	\$0.005073
NORTH FT. MYERS, FL	5	\$0.005073

MCImetro - Sprint  
Florida Agreement

Sprint - Florida Switching Interconnection Rates  
Docket # 961230 - TP  
(03/14/97)

Exchange	Rate Band	Interim Rate
REEDY CREEK, FL	5	\$0.005073
ST. CLOUD, FL	5	\$0.005073
STARKE, FL	5	\$0.005073
WINDERMERE, FL	5	\$0.005073
CLEWISTON, FL	6	\$0.006313
DEFUNIAK SPRINGS, FL	6	\$0.006313
GROVELAND, FL	6	\$0.006313
MOORE HAVEN, FL	6	\$0.006313
PINE ISLAND, FL	6	\$0.006313
PUNTA GORDA, FL	6	\$0.006313
SAN ANTONIO, FL	6	\$0.006313
SEBRING, FL	6	\$0.006313
TRILLACOOCHEE, FL	6	\$0.006313
WAUCHULA, FL	6	\$0.006313
ZOLFO SPRINGS, FL	6	\$0.006313
BUSHNELL, FL	7	\$0.007766
CAPE HAZE, FL	7	\$0.007766
LAKE PLACID, FL	7	\$0.007766
MARIANNA, FL	7	\$0.007766
SANIBEL ISLAND, FL	7	\$0.007766
SHALIMAR, FL	7	\$0.007766
SPRING LAKE, FL	7	\$0.007766

MCImetro - Sprint  
Florida Agreement

Sprint - Florida Local Switching Rates  
Docket # 961230 - TP  
(03/14/97)

Exchange	Rate Band	Interim Rate
ALTAMONTE SPRINGS, FL	1	\$5.82
BONITA SPRINGS, FL	1	\$5.82
CYPRESS LAKE, FL	1	\$5.82
FT MYERS BEACH, FL	1	\$5.82
FT. MYERS, FL	1	\$5.82
FT. WALTON BEACH, FL	1	\$5.82
GOLDENROD, FL	1	\$5.82
LAKE BRANTLEY, FL	1	\$5.82
TALLAHASSEE, FL	1	\$5.82
WINTER PARK, FL	1	\$5.82
APOPKA, FL	2	\$7.72
CASSELBERRY, FL	2	\$7.72
CHERRY LAKE, FL	2	\$7.72
CRYSTAL RIVER, FL	2	\$7.72
DESTIN, FL	2	\$7.72
EUSTIS, FL	2	\$7.72
FREEPORT, FL	2	\$7.72
INVERNESS, FL	2	\$7.72
LADY LAKE, FL	2	\$7.72
LEESBURG, FL	2	\$7.72
MADISON, FL	2	\$7.72
MARCO ISLAND, FL	2	\$7.72
MONTICELLO, FL	2	\$7.72
MT. DORA, FL	2	\$7.72
NAPLES MOORINGS, FL	2	\$7.72
NAPLES, FL	2	\$7.72
NORTH NAPLES, FL	2	\$7.72
OCALA, FL	2	\$7.72
ORANGE CITY, FL	2	\$7.72
PORT CHARLOTTE, FL	2	\$7.72
SANTA ROSA, FL	2	\$7.72
SEA GROVE BEACH, FL	2	\$7.72
WILDWOOD, FL	2	\$7.72
ALFORD, FL	3	\$8.99
ARCADIA, FL	3	\$8.99
ASTOR, FL	3	\$8.99
BAKER, FL	3	\$8.99
BONIFAY, FL	3	\$8.99
BOWLING GREEN, FL	3	\$8.99
COTTONDALE, FL	3	\$8.99
EVERGLADES, FL	3	\$8.99
GLENDALE, FL	3	\$8.99
GREENVILLE, FL	3	\$8.99
GREENWOOD, FL	3	\$8.99

MCImetro - Sprint  
Florida Agreement

Sprint - Florida Local Switching Rates  
Docket # 961230 - TP  
(03/14/97)

Exchange	Rate Band	Interim Rate
HOWEY-IN-THE-HILLS, FL	3	\$8.99
KENANSVILLE, FL	3	\$8.99
KINGSLEY LAKE, FL	3	\$8.99
KISSIMMEE, FL	3	\$8.99
LAWTEY, FL	3	\$8.99
LEE, FL	3	\$8.99
MAITLAND, FL	3	\$8.99
MALONE, FL	3	\$8.99
MONTVERDE, FL	3	\$8.99
OKLAWAHA, FL	3	\$8.99
PANACEA, FL	3	\$8.99
PONCE DE LEON, FL	3	\$8.99
REYNOLDS HILL, FL	3	\$8.99
SALT SPRINGS, FL	3	\$8.99
SILVER SPRINGS SHORES, FL	3	\$8.99
SNEADS, FL	3	\$8.99
SOPCHOPPY, FL	3	\$8.99
ST. MARKS, FL	3	\$8.99
TAVARES, FL	3	\$8.99
UMATILLA, FL	3	\$8.99
VALPRAISO, FL	3	\$8.99
WEST KISSIMMEE, FL	3	\$8.99
WESTVILLE, FL	3	\$8.99
WILLISTON, FL	3	\$8.99
WINTER GARDEN, FL	3	\$8.99
BELLEVIEW, FL	4	\$10.08
BEVERLY HILLS, FL	4	\$10.08
BOCA GRANDE, FL	4	\$10.08
CAPE CORAL, FL	4	\$10.08
CLEWISTON, FL	4	\$10.08
CRESTVIEW, FL	4	\$10.08
DADE CITY, FL	4	\$10.08
DEFUNIAK SPRINGS, FL	4	\$10.08
FOREST, FL	4	\$10.08
FORT MEADE, FL	4	\$10.08
HOMOSASSA SPRINGS, FL	4	\$10.08
LEHIGH ACRES, FL	4	\$10.08
MOORE HAVEN, FL	4	\$10.08
NORTH CAPE CORAL, FL	4	\$10.08
NORTH FT. MYERS, FL	4	\$10.08
OKEECHOBEE, FL	4	\$10.08
PINE ISLAND, FL	4	\$10.08
REEDY CREEK, FL	4	\$10.08
SHADY ROAD, FL	4	\$10.08
ST. CLOUD, FL	4	\$10.08

MCImetro - Sprint  
Florida Agreement

Sprint - Florida Local Switching Rates  
Docket # 961230 - TP  
(03/14/97)

Exchange	Rate Band	Interim Rate
STARKE, FL	4	\$10.08
WAUCHULA, FL	4	\$10.08
WINDERMERE, FL	4	\$10.08
ZOLFO SPRINGS, FL	4	\$10.08
AVON PARK, FL	5	\$11.66
CLERMONT, FL	5	\$11.66
CRAWFORDVILLE, FL	5	\$11.66
GROVELAND, FL	5	\$11.66
IMMOKALEE, FL	5	\$11.66
LABELLE, FL	5	\$11.66
PUNTA GORDA, FL	5	\$11.66
SAN ANTONIO, FL	5	\$11.66
TRILLACOOCHEE, FL	5	\$11.66
BUSHNELL, FL	6	\$13.83
CAPE HAZE, FL	6	\$13.83
LAKE PLACID, FL	6	\$13.83
MARIANNA, FL	6	\$13.83
SANIBEL ISLAND, FL	6	\$13.83
SEBRING, FL	6	\$13.83
SHALIMAR, FL	6	\$13.83
SPRING LAKE, FL	6	\$13.83

**TABLE OF CONTENTS**

**Attachment II  
LOCAL RESALE**

Section 1.	Telecommunications Services Provided for Resale	II-1
Section 2.	General Terms and Conditions for Resale	II-2
Section 3.	Service Functions	II-6



## ATTACHMENT II

### LOCAL RESALE

#### **Section 1. Telecommunications Services Provided for Resale**

1.1 At the request of MCI, and pursuant to the requirements of the Act, and FCC Rules and Regulations, Sprint shall make available to MCI for unrestricted resale any Telecommunications Services that Sprint currently provides or may offer hereafter, except as such resale may be restricted pursuant to FCC Rules and Regulations and State Rules and Regulations. Sprint shall also provide service functions, as set forth in this Attachment II. The Telecommunications Services and service functions provided by Sprint to MCI pursuant to this Agreement are collectively referred to as "Local Resale."

1.2 To the extent that this Attachment describes services which Sprint shall make available to MCI for resale pursuant to this Agreement, this list of services is neither all inclusive nor exclusive. All Telecommunications Services of Sprint which are to be offered for resale are subject to the terms herein.

1.3 **Features and Functions Subject to Resale.** Sprint shall make all of its Telecommunications Services available for resale to MCI on terms and conditions that are reasonable and nondiscriminatory.

1.4 Sprint will provide MCI with at least the capability to provide an MCI subscriber at least the same level of service quality as Sprint provides its own subscribers with respect to all Telecommunications Services and shall provide such capability in accordance with the specific requirements of Attachment VIII, Sections 1, 2, 6.3 and 6.4.

1.5 The specific business process requirements and systems interface requirements are set forth in Attachment VIII, Sections 1, 2, 6.3 and 6.4.

**Section 2. General Terms and Conditions for Resale**

**2.1 Pricing.** The prices charged to MCIIm for Local Resale are set forth in Attachment I of this Agreement.

**2.2 No Restrictions on Resale.** MCIIm may resell to any and all classes of end users Telecommunications Services obtained from Sprint under this Agreement, except for Lifeline Assistance and Link-Up or similar services, which MCIIm may only resell to those subscribers who are eligible for such services. Sprint will not prohibit, nor impose unreasonable or discriminatory conditions or limitations on the resale of its Telecommunications Service except as such resale may be prohibited or restricted pursuant to FCC Rules and Regulations and State Rules and Regulations.

**2.3 Requirements for Specific Services**

**2.3.1 CENTREX Requirements**

2.3.1.1 At MCIIm's option, MCIIm may purchase the entire set of CENTREX features or a subset of any one or any combination of such features. The CENTREX Service provided for resale will meet the requirements of this Subsection 2.3.1.1.

2.3.1.2 All features and functions of CENTREX Service, including CENTREX Management System ("CMS"), whether offered under tariff or otherwise, shall be available to MCIIm for resale.

2.3.1.3 Sprint shall make information required for an "as is" transfer of CENTREX subscriber service,<sup>1</sup> features, functionalities and CMS capabilities available to MCIIm.

2.3.1.4 All service levels and features of CENTREX Service provided by Sprint for resale by MCIIm shall be at Parity with the service levels and features of CENTREX Service Sprint provides its subscribers.

2.3.1.5 Consistent with Sprint's tariffs, MCIIm may aggregate the CENTREX local exchange and IntraLATA traffic usage of MCIIm subscribers to qualify for volume discounts on the basis of such aggregated usage.

2.3.1.6 MCIIm may require that Sprint suppress the need for MCIIm subscribers to dial "9" when placing calls outside the CENTREX System.

2.3.1.7 MCIIm may resell call forwarding in conjunction with CENTREX Service.

2.3.1.8 MCIIm may purchase any CENTREX Service for resale subject to the minimum number of lines required by Sprint's tariff to qualify for CENTREX Service, but otherwise without restriction on the maximum number of lines that may be purchased for such service.

2.3.1.9 Sprint shall make available to MCIIm for resale intercom calling within the same CENTREX system. To the extent that Sprint offers its own subscribers intercom calling between different CENTREX systems, Sprint shall make such capability available to MCIIm for resale.

2.3.1.10 MCIIm may resell Automatic Route Selection ("ARS"). MCIIm may aggregate multiple MCIIm subscribers on dedicated access facilities where such aggregation is allowed by law, rule or regulation.

**2.3.2 Voluntary Federal and State Subscriber Financial Assistance Programs.** Subsidized local Telecommunications Services are provided to low-income subscribers pursuant to requirements established by the appropriate state regulatory body, and include programs such as Voluntary Federal Subscriber Financial Assistance Program and Link-Up America. When a Sprint subscriber who is eligible for such a federal program or other similar state program chooses to obtain Local Resale from MCIIm and MCIIm serves such subscriber via Local Resale, Sprint shall identify such subscriber's eligibility to participate in such programs to MCIIm in accordance with the procedures set forth herein. This notification shall be in electronic format when such an interface is in place.

**2.3.3 Lifeline/Link-Up Service.** MCIIm will forward to Sprint all information regarding a subscriber's program eligibility, status and certification when a MCIIm subscriber currently on any government telephone assistance program changes

service to MCI as their local exchange carrier. MCI will cooperate with Sprint so that Sprint may attain any subsidy associated with a subscriber transfer to MCI.

**2.3.4 Grandfathered Services.** Sprint shall offer for resale to MCI all Grandfathered Services. Sprint shall make reasonable efforts to provide MCI with advance copy of any request for the termination of service and/or grandfathering to be filed by Sprint with the Commission.

**2.3.5 N11 Service**

2.3.5.1 Sprint agrees not to offer any new N11 Telecommunications Services after the Effective Date of this Agreement unless Sprint makes any such service available for resale.

2.3.5.2 MCI shall have the right to resell any N11 Telecommunications Service, including but not limited to 411 or 611 services, existing as of the Effective Date. These services shall be unbranded and routed to MCI, as required by MCI pursuant to Part A, Section 25.

**2.3.6 Contract Service Arrangements, Special Arrangements, and Promotions.** Sprint shall offer for resale all of its Telecommunications Services available to any retail subscriber, including but not limited to Contract Service Arrangements (or Individual Case Basis "ICB"), Special Arrangements (or ICB), and Promotions, all in accordance with FCC Rules and Regulations.

**2.3.7 Discount Plans.** Sprint shall offer for resale all Discount Plans for Telecommunications Services in accordance with FCC Rules and Regulations.

**2.3.8 [INTENTIONALLY LEFT BLANK]**

**2.3.9 Pay Phone Service**

2.3.9.1 Sprint shall offer for resale all coin and coinless pay phone local services, features and functionalities that it provides to its own pay phone operations and to independent pay phone providers. Sprint will also provide all support and service

functions, as described in Section 276 of the ACT, and FCC and state regulations, at Parity with those provided for its own pay phone local services including, without limitation:

- coin rating
- answer supervision
- access to maintenance/diagnostic platform
- call blocking
- call screening
- timing
- far-end disconnect recognition
- ANI information digits
- fraud protection

2.3.9.2 Sprint also must provide billing detail showing all 1+ traffic in EMR format and transferred to MCIIm via NDM.

### **2.3.10 Voice Mail Service**

2.3.10.1 MCIIm shall have the right to resell Sprint voice mail services.

2.3.10.2 Where available, Sprint shall make available the SMDI-E (Station Message Desk Interface-Enhanced), or SMDI (Station Message Desk Interface) where SMDI-E is not available, feature capability allowing for voice mail services. Sprint shall make available the MWI (Message Waiting Indicator) stutter dialtone and message waiting light feature capabilities. Sprint shall make available CF-B/DA (Call Forward on Busy/Don't Answer), CF-B (Call Forward on Busy), and CF/DA (Call Forward/Don't Answer) feature capabilities allowing for voice mail services.

### **2.3.11 Hospitality Service**

2.3.11.1 Sprint shall provide all blocking, screening, and all other applicable functions available for hospitality lines under tariff.

**2.3.12 Telephone Line Number Calling Cards.** Sprint shall maintain customer information for MCIIm customers who subscribe to resold Sprint local service dialtone lines, in Sprint's LIDB in the same manner that it maintains information in LIDB for its own similarly situated end user subscribers. Sprint shall update and maintain, on the same schedule that it uses for its own similarly situated end user subscribers, the MCIIm + information in LIDB. Until such time as Sprint's LIDB has the software capability to recognize a resold number as MCIIm's, Sprint shall store the resold number in its LIDB at no charge and shall retain revenue for LIDB look-ups to the resold number. At such time as Sprint's LIDB has the software capability to recognize that the resold number is MCIIm's then, if MCIIm desires to store resold numbers on Sprint's LIDB, the Parties shall negotiate a separate LIDB database storage and look-up agreement.

### ***Section 3. Service Functions***

3.1 Sprint shall provide MCIIm with the information MCIIm will need to certify subscribers as exempt from charges (including taxes), or eligible for reduced charges associated with providing services, including but not limited to handicapped individuals, and certain governmental bodies and public institutions and shall not bill MCIIm for such services.

3.2 Whenever possible Sprint shall provide MCIIm with appropriate notification of all local service boundary changes with line level detail one hundred twenty (120) days before service transfer, and will also notify MCIIm within one hundred twenty (120) days before such change of any LATA boundary changes.

3.3 Sprint will work cooperatively with MCIIm in practices and procedures regarding the handling of law enforcement and service annoyance calls.

**TABLE OF CONTENTS****Attachment III  
NETWORK ELEMENTS**

Section 1.	Introduction	III-1
Section 2.	Unbundled Network Elements	III-1
Section 3.	Standards for Network Elements	III-3
Section 4.	Loop	III-4
Section 5.	Network Interface Device	III-13
Section 6.	Distribution	III-15
Section 7.	Local Switching	III-18
Section 8.	Operator Systems	III-26
Section 9.	Common Transport	III-26
Section 10.	Dedicated Transport	III-29
Section 11.	Signaling Link Transport	III-41
Section 12.	Signaling Transfer Points ("STPs")	III-42
Section 13.	Service Control Points/Databases	III-49
Section 14.	Tandem Switching	III-57
Section 15.	Additional Requirements	III-60
Section 16.	Basic 911 and E911	III-105
Section 17.	Directory Assistance Data	III-105

## ATTACHMENT III

### NETWORK ELEMENTS

#### ***Section 1. Introduction***

Sprint will unbundle and separately price and offer Network Elements such that MCIIm will be able to subscribe to and interconnect to whichever of these unbundled elements MCIIm requires for the purpose of providing local telephone service to its end users, and to combine Sprint-provided elements with any facilities and services that MCIIm may itself provide, in order to efficiently provide Telecommunications Services to its end users, pursuant to the following terms. Except as otherwise set forth in this Attachment III, MCIIm may order Network Elements as of the Approval Date.

#### ***Section 2. Unbundled Network Elements***

2.1 Sprint shall offer Network Elements to MCIIm for the purpose of offering Telecommunications Services to MCIIm subscribers. Sprint shall offer Network Elements to MCIIm on an unbundled basis on rates, terms and conditions that are just, reasonable, and non-discriminatory in accordance with the terms and conditions of this Agreement.

2.2 Sprint shall permit MCIIm to connect MCIIm's facilities or facilities provided to MCIIm by third parties with each of Sprint's unbundled Network Elements at any point designated by MCIIm that is Technically Feasible.

2.3 MCIIm may use one or more Network Elements to provide any feature, function, capability, or service option that such Network Element(s) is technically capable of providing.

2.3.1 MCIIm may, at its option, designate any Technically Feasible method of access to unbundled elements, including access methods currently or previously in use.

2.4 Sprint shall offer each Network Element individually and any Technically Feasible combination with any other Network Element or Network Elements in order to permit MCIIm to provide Telecommunications Services to its subscribers, provided that such combination would not impair the ability of other carriers to obtain access to unbundled Network Elements or to interconnect with the incumbent Sprint's network.



2.5 For each Network Element, that MCIIm purchases on stand alone basis, Sprint shall provide a demarcation point (e.g., at a Digital Signal Cross Connect, Light Guide Cross Connect panel or a Main Distribution Frame). Where Sprint provides combined Network Elements, no demarcation point shall exist between such contiguous Network Elements, and Sprint shall perform, at its expense, any work necessary to interconnect such Network Elements.

2.6 Charges in Attachment I are inclusive and no other charges apply, except as otherwise mutually agreed including, but not limited to, any other consideration for connecting any Network Element(s) with other Network Element(s).

2.7 This Attachment describes the initial set of Network Elements which MCIIm and Sprint have identified as of the Effective Date of this Agreement:

- Local Loop
- Network Interface Device ("NID")
- Switching Capability
  - Local Switching
  - Tandem Switching
- Interoffice Transmission Facilities
  - Dedicated
  - Shared
- Signaling Networks & Call Related Databases
- Operations Support Systems
- Operator Services & Directory Assistance

2.8 MCIIm may identify additional or revised Network Elements as necessary to provide Telecommunications Services to its subscribers, to improve network or service efficiencies or to accommodate changing technologies, subscriber demand, or other requirements.

2.9 MCIIm will request such Network Elements in accordance with the Bona Fide Request process described in Section 24 of Part A. Additionally, if Sprint provides any Network Element that is not identified in this Agreement, to itself, to its own subscribers, to a Sprint Affiliate or to any other entity, Sprint shall make available the same Network Element to MCIIm on terms and conditions no less favorable to MCIIm than those provided to itself or to any other party.

### **Section 3. Standards for Network Elements**

3.1 Each Network Element shall be furnished at a service level equal to or better than the requirements set forth in the technical references referenced in the following, as well as any Performance or other requirements, identified herein. In the event Bell Communications Research, Inc. ("Bellcore"), or industry standard (e.g., American National Standards Institute ("ANSI")) technical reference or a more recent version of such reference sets forth a different requirement, the Parties will agree upon which standard shall apply.

3.2 If one or more of the technical requirements set forth in this Attachment III are in conflict, the Parties will agree upon which requirement shall apply except where such election shall impair the ability of other carriers to obtain access to unbundled Network Elements or to interconnect with Sprint's network, in which event, if Technically Feasible, Sprint shall provide an alternative arrangement on commercially reasonable terms.

3.3 Each Network Element provided by Sprint to MCI shall be at least equal in the quality of design, Performance, features, functions, capabilities and other characteristics including, but not limited to, levels and types of redundant equipment and facilities for power, diversity and security, that Sprint provides to itself, Sprint's own subscribers, to a Sprint Affiliate or to any other entity.

3.3.1 Sprint shall provide to MCI, within ten (10) business days of MCI's request [where commercially reasonable], engineering, design and Performance data sufficient for MCI to determine that the requirements of this Section 3 are being met. Where it is not commercially reasonable to provide such information, the Parties shall mutually agree upon a schedule. In the event that such data indicates that the requirements of this Section 3 are not being met, Sprint shall, within ten (10) days of delivering such data to MCI: (a) cure any design, Performance or other deficiency and provide new data sufficient for MCI to determine that such deficiencies have been cured; or (b) upon MCI's consent, such consent not to be unreasonably withheld, undertake efforts to cure any design, Performance or other deficiency within a reasonable time period and thereafter provide new data sufficient for MCI to determine that such deficiencies have been cured.

3.4 Unless otherwise requested by MCI, each Network Element and the connections between Network Elements provided by Sprint to MCI shall be made available to MCI on a priority basis, at any Technically

Feasible point, that is equal to or better than the priorities that Sprint provides to itself, Sprint's own subscribers, to a Sprint Affiliate or to any other entity.

## **Section 4. Loop**

### **4.1 Definition**

4.1.1 A Loop is a transmission path between a Distribution frame (cross-connect), or its equivalent, in a Sprint Central Office or Wire Center, and the network interface device at a subscriber's premises, to which MCI is granted exclusive use. This includes, but is not limited to, two-wire and four-wire analog voice-grade Loops, and two-wire and four-wire Loops that are conditioned to transmit the digital signals needed to provide ISDN, ADSL, HDSL, and DS1-level signals. A Loop may be composed of the following components:

- Loop Concentrator/Multiplexer
- Loop Feeder
- Distribution

Sprint requires MCI to provide in writing the grade of service desired in a particular Loop F (e.g., ISDN-BRI, PRI, ADSL, HDSL, DS1, etc.) so that the Loop may be engineered to meet the appropriate transmission requirements. If MCI requires a change in the grade of service of a particular Loop, MCI will notify Sprint in writing of the requested change in grade of service. If Sprint is unable to provide the new level of service to MCI, Sprint will notify MCI that it is unable to meet MCI's request. If a particular grade of service is installed but MCI uses the Loop to provide a service that exceeds the engineered capacity of a medium (i.e., interferes with other services) a mutually agreed upon process will be developed to resolve the issue.

4.1.2 If Sprint uses Integrated Digital Loop Carrier or other similar remote concentration devices, Sprint will make alternative arrangements at MCI's request, to provide an unbundled local Loop. Alternative arrangements may include copper facilities, dedicated transmission equipment or the deployment of newer devices providing for multiple hosting. The cost of modifications will be recovered from the requesting carrier.

## **4.2. Technical Requirements**

Subdivided to each component as detailed below.

## **4.3 Interface Requirements**

Subdivided to each component as detailed below.

## **4.4 Loop Components**

### **4.4.1 Loop Concentrator/Multiplexer**

#### **4.4.1.1 Definition**

**4.4.1.1.1** The Loop Concentrator/Multiplexer is the Network Element that: (1) aggregates lower bit rate or bandwidth signals to higher bit rate or bandwidth signals (multiplexing); (2) disaggregates higher bit rate or bandwidth signals to lower bit rate or bandwidth signals (demultiplexing); (3) aggregates a specified number of signals or channels to fewer channels (concentrating); (4) performs signal conversion, including encoding of signals (e.g., analog to digital and digital to analog signal conversion); and (5) in some instances performs electrical to optical ("E/O") conversion.

**4.4.1.1.2** The Loop Concentrator/Multiplexer function may be provided through a Digital Loop Carrier ("DLC") system, channel bank, multiplexer or other equipment at which traffic is encoded and decoded, multiplexed and demultiplexed, or concentrated.

#### **4.4.1.2 Technical Requirements**

**4.4.1.2.1** The Loop Concentrator/Multiplexer shall be capable of performing its functions on the signals for the following services, including, but not limited to, (as needed by MCI to provide end-to-end service capability to its subscriber):

**4.4.1.2.1.1** Two-wire and four-wire analog voice grade Loops;

4.4.1.2.1.2 Two-wire and four-wire Loops that are conditioned to transmit the digital signals needed to provide services such as ISDN, ADSL, HDSL, and DS1-level signals;

4.4.1.2.1.3 4-wire digital data (2.4Kbps through 64Kbps and n times 64Kbps (where  $n \leq 24$ ));

4.4.1.2.1.4 DS3 rate private lines; and

4.4.1.2.1.5 Optical SONET rate private lines.

4.4.1.2.2 The Loop Concentrator/Multiplexer shall perform the following functions as appropriate:

4.4.1.2.2.1 Analog to digital signal conversion of both incoming and outgoing (upstream and downstream) analog signals;

4.4.1.2.2.2 Multiplexing of the individual digital signals up to higher transmission bit rate signals (e.g., DS0, DS1, DS3, or optical SONET rates) for transport to the Sprint Central Office through the Loop Feeder; and

4.4.1.2.2.3 Concentration of end user subscriber signals onto fewer channels of a Loop Feeder. The concentration ratio shall be as mutually agreed by the Parties.

4.4.1.2.3 Where available in Sprint's network, Sprint shall provide power for the Loop Concentrator/Multiplexer, through a non-interruptible source if the function is performed in a Central Office, or from a commercial AC power source with battery backup if the equipment is located outside a Central Office. Such power shall also adhere to the requirements stated herein.

4.4.1.2.4 The Loop Concentrator/Multiplexer shall be provided to MCI in accordance with the following Technical References:

4.4.1.2.4.1 Bellcore TR-NWT-000057, Functional Criteria for Digital Loop Carrier Systems, Issue 2, January 1993;

4.4.1.2.4.2 Bellcore TR-NWT-000393, Generic Requirements for ISDN Basic Access Digital Subscriber Lines;

4.4.1.2.4.3 ANSI T1.106 - 1988, American National Standard for Telecommunications - Digital Hierarchy - Optical Interface Specifications (Single Mode);

4.4.1.2.4.4 ANSI T1.105-1995, American National Standard for Telecommunications - Synchronous Optical Network ("SONET") - Basic Description including Multiplex Structure, Rates and Formats;

4.4.1.2.4.5 ANSI T1.102-1993, American National Standard for Telecommunications - Digital Hierarchy - Electrical Interfaces;

4.4.1.2.4.6 ANSI T1.403-1989, American National Standard for Telecommunications - Carrier to Subscriber Installation, DS1 Metallic Interface Specification;

4.4.1.2.4.7 Bellcore GR-253-CORE, Synchronous Optical Network Systems ("SONET"), Common Generic Criteria;

4.4.1.2.4.8 Bellcore TR-TSY-000008, Digital Interface Between the SLC 96 Digital Loop Carrier System and a Local Digital Switch, Issue 2, August 1987;

4.4.1.2.4.9 Bellcore TR-NWT-000303, Integrated Digital Loop Carrier System Generic Requirements, Objectives and Interface, Issue 2, December 1992; Rev. 1, December 1993; Supplement 1, December 1993;

4.4.1.2.4.10 Bellcore TR-TSY-000673, Operations Systems Interface for an IDLC

System, ("LSSGR") FSD 20-02-2100, Issue 1, September 1989; and

4.4.1.2.4.11 Bellcore Integrated Digital Loop Carrier System Generic Requirements, Objectives and Interface, GR-303-CORE, Issue 1, September 1995.

#### **4.4.1.3 Requirements for an Intelligent Loop Concentrator/Multiplexer**

4.4.1.3.1 In addition to the basic functions described above for the Loop Concentrator/Multiplexer, the Intelligent Loop Concentrator/Multiplexer ("IC/M") shall provide facility grooming, facility test functions, format conversion and signaling conversion as appropriate.

4.4.1.3.2 The underlying equipment that provides such IC/M function shall continuously monitor protected circuit packs and redundant common equipment.

4.4.1.3.3 The underlying equipment that provides such IC/M function shall automatically switch to a protection circuit pack on detection of a failure or degradation of normal operation.

4.4.1.3.4 Where available in Sprint's network the underlying equipment that provides such IC/M function shall be equipped with a redundant power supply or a battery back-up.

4.4.1.3.5 At MCI's option, Sprint shall provide MCI with Real Time Performance monitoring and alarm data on IC/M elements that may affect MCI's traffic. This includes IC/M hardware alarm data and facility alarm data on the underlying device that provides such IC/M function, where Technically Feasible.

4.4.1.3.6 At MCI's option, Sprint shall provide MCI with Real Time ability to initiate tests on the underlying device that provides such IC/M function integrated test equipment as well as other integrated

functionality for routine testing and fault isolation, where Technically Feasible

#### 4.4.1.4 Interface Requirements

4.4.1.4.1 The Loop Concentrator/Multiplexer shall meet the following interface requirements, as appropriate for the configuration that MCI designates:

4.4.1.4.1.1 The Loop Concentrator/Multiplexer shall provide an analog voice frequency copper twisted pair interface at the serving Wire Center, as described in the technical references in Subsection 4.4.1.2.4.

4.4.1.4.1.2 The Loop Concentrator/Multiplexer shall provide digital 4-wire electrical interfaces at the serving Wire Center, as described in the technical references in Subsection 4.4.1.2.4.

4.4.1.4.1.3 The Loop Concentrator/Multiplexer shall provide optical SONET interfaces at rates of OC-3, OC-12, OC-48, and OC-N (N as described in the technical references in Subsection 4.4.1.2.4).

4.4.1.4.1.4 The Loop Concentrator/Multiplexer shall provide the Bellcore TR-303 DS1 level interface at the serving Wire Center. Loop Concentrator/ Multiplexer shall provide Bellcore TR-08 modes 1&2 DS1 interfaces when designated by MCI. Such interface requirements are specified in the technical references in Subsection 4.4.1.2.4.

4.4.1.5 The Intelligent Loop Concentrator/Multiplexer shall be provided to MCI in accordance with the Technical References set forth in Subsections 4.4.1.2.4.8 through 4.4.1.2.4.11 above



## 4.4.2 Loop Feeder

### 4.4.2.1 Definition

The Loop Feeder is the Network Element that provides connectivity between: (1) a Feeder Distribution Interface ("FDI") associated with Loop Distribution and a termination point appropriate for the media in a Central Office; or (2) a Loop Concentrator/Multiplexer provided in a remote terminal and a termination point appropriate for the media in a Central Office. Sprint shall provide MCI physical access to the FDI, and the right to connect the Loop Feeder to the FDI.

### 4.4.2.2 Requirements for Loop Feeder

4.4.2.2.1 The Loop Feeder shall be capable of transmitting analog voice frequency, basic rate ISDN or low speed digital data.

4.4.2.2.2 Sprint shall provide appropriate power for all active elements in the Loop Feeder. Sprint will provide appropriate power from a Central Office source, or from a commercial AC source with rectifiers for AC to DC conversion and eight (8) hour battery back-up without a generator when the equipment is located in an outside plant Remote Terminal ("RT") and two (2) hour battery back-up when the equipment is located in an outside plant Remote Terminal with a generator.

### 4.4.2.3 Additional Requirements for Special Copper Loop Feeder Medium

In addition to requirements set forth in Section 4.1.1 and Section 4.2 (above), MCI may require Sprint to provide copper twisted pair Loop Feeder which is unfettered by any intervening equipment (e.g., filters, load coils, and range extenders), so that MCI can use these Loop Feeders for a variety of services that can only be supported by use of copper by attaching appropriate terminal equipment at the ends. If such facilities don't exist, MCI may order special construction at MCI's expense.

#### **4.4.2.4 Additional Technical Requirements for DS1 Conditioned Loop Feeder**

In addition to the requirements set forth in Subsection 4.4.2.2 above, MCI may designate that the Loop Feeder be conditioned to transport a DS1 signal. The requirements for such transport are defined in the references below in Subsection 4.4.2.6.

#### **4.4.2.5 Additional Technical Requirements for Optical Loop Feeder**

In addition to the requirements set forth in Subsection 4.4.2.2 above, MCI may designate that Loop Feeder will transport DS3 and OC-N (where N is defined in the Technical Reference in Subsection 4.4.1.2.4. The requirements for such transport are defined in the references below in Subsection 4.4.2.6.

4.4.2.6 Sprint shall offer Loop Feeder in accordance with the requirements set forth in the following Technical References:

4.4.2.6.1 Bellcore Technical Requirement TR-NWT-000499, Issue 5, December 1993, Section 7 for DS1 interfaces;

4.4.2.6.2 Bellcore TR-NWT-000057, Functional Criteria for Digital Loop Carrier Systems, Issue 2, January 1993;

4.4.2.6.3 Bellcore TR-NWT-000393, Generic Requirements for ISDN Basic Access Digital Subscriber Lines;

4.4.2.6.4 ANSI T1.106-1988, American National Standard for Telecommunications - Digital Hierarchy Optical Interface Specifications (Single Mode);

4.4.2.6.5 ANSI T1.105-1995, American National Standard for Telecommunications - Synchronous Optical Network ("SONET") - Basic Description, including Multiplex Structure, Rates and Formats.

4.4.2.6.6 ANSI T1.102-1993, American National Standard for Telecommunications - Digital Hierarchy - Electrical Interfaces;

4.4.2.6.7 ANSI T1.403-1989, American National Standard for Telecommunications - Carrier to Subscriber Installation, DS1 Metallic Interface Specification; and

4.4.2.6.8 Bellcore GR-253-CORE, Synchronous Optical Network Systems ("SONET"), Common Generic Criteria.

#### **4.4.2.7 Interface Requirements**

4.4.2.7.1 The Loop Feeder point of termination ("POT") within a Sprint Central Office will be as follows:

4.4.2.7.1.1 Copper twisted pairs shall terminate on the MDF;

4.4.2.7.1.2 DS1 Loop Feeder shall terminate on a DSX1, DCS1/0 or DCS3/1; and

4.4.2.7.1.3 Fiber Optic cable shall terminate on a LGX.

4.4.2.7.2 Loop Feeder shall be equal to or better than each of the applicable interface requirements set forth in the following technical references:

4.4.2.7.2.1 Bellcore TR-TSY-000008, Digital Interface Between the SLC 96 Digital Loop Carrier System and a Local Digital Switch, Issue 2, August 1987;

4.4.2.7.2.2 Bellcore TR-NWT-000303, Integrated Digital Loop Carrier System Generic Requirements, Objectives and Interface, [Issue 2, December 1992-1, Rev. 1, December 1993-1, Supplement 1, December 1993].

4.4.2.7.2.3 Bellcore Integrated Digital Loop Carrier System Generic Requirements.

Objectives and Interface, GR-303-CORE,  
Issue 1, September 1995.

**Section 5. Network Interface Device**

**5.1 Definition**

5.1.1 The Network Interface Device ("NID") is a single-line termination device or that portion of a multiple-line termination device required to terminate a single line or circuit. The function of the NID is to establish the network demarcation point between a carrier and its subscriber. The NID features two (2) independent chambers or divisions which separate the service provider's network from the subscriber's inside wiring. Each chamber or division contains the appropriate connection points or posts to which the service provider, and the subscriber each make their connections. The NID or protector provides a protective ground connection, provides protection against lightning and other high voltage surges and is capable of terminating cables such as twisted pair cable.

5.1.2 MCI may connect its NID to Sprint's NID.

5.1.3 With respect to multiple-line termination devices, MCI shall specify the quantity of NIDs it requires within such a device.

5.1.4 Figure 1 shows a schematic of a NID.

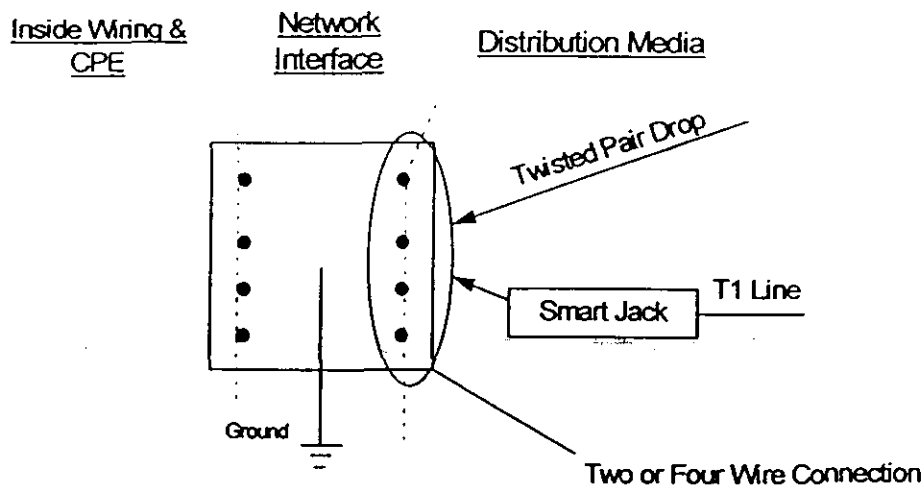

**Figure 1. Network Interface Device ("NID")**

## 5.2 Technical Requirements

5.2.1 The Sprint Network Interface Device shall provide a clean, accessible point of connection for the inside wiring and for the Distribution Media and/or cross-connect to MCI's NID and shall maintain a connection to ground that meets the requirements set forth below. Each Party shall ground its NID independent of the other Party's NID.

5.2.2 The Sprint NID shall be capable of transferring electrical analog or digital signals between the subscriber's inside wiring and the Distribution media and/or cross-connect to MCI's NID.

5.2.3 All Sprint NID posts or connecting points shall be in place, secure, usable and free of any rust or corrosion. The protective ground connection shall exist and be properly installed. The ground wire shall be free of rust or corrosion and have continuity relative to ground.

5.2.4 The Sprint NID shall be capable of withstanding all normal local environmental variations.

5.2.5 The Sprint NID shall be physically accessible to MCI designated personnel. In cases where entrance to the subscriber

premises is required to give access to the NID, MCI shall obtain entrance permission directly from the subscriber.

5.2.6 Sprint shall offer the NID together or separately from the Distribution Media component of Loop Distribution.

### **5.3 Interface Requirements**

5.3.1 The NID shall be the interface to subscribers' premises wiring for all Loop technologies.

5.3.2 The NID shall be equal to or better than all of the industry standards for NIDs set forth in the following technical references:

5.3.2.1 Bellcore Technical Advisory TA-TSY-000120  
"Subscriber Premises or Network Ground Wire";

5.3.2.2 Bellcore Generic Requirement GR-49-CORE  
"Generic Requirements for Outdoor Telephone Network Interface Devices";

5.3.2.3 Bellcore Technical Requirement TR-NWT-00239  
"Indoor Telephone Network Interfaces";

5.3.2.4 Bellcore Technical Requirement TR-NWT-000937  
"Generic Requirements for Outdoor and Indoor Building Entrance"; and

5.3.2.5 Bellcore Technical Requirement TR-NWT-000133  
"Generic Requirements for Network Inside Wiring."

## **Section 6. Distribution**

### **6.1 Definition**

6.1.1 Distribution provides connectivity between the NID component of Loop Distribution and the terminal block on the subscriber-side of a Feeder Distribution Interface ("FDI"). The FDI is a device that terminates the Distribution Media and the Loop Feeder, and cross-connects them in order to provide a continuous transmission path between the NID and a telephone company Central Office. There are three (3) basic types of feeder-Distribution connection: (i) multiple (splicing of multiple Distribution pairs onto one feeder pair); (ii) dedicated ("home run"); and (iii) interfaced ("cross-connected"). While older plant uses multiple and

dedicated approaches, newer plant and all plant that uses DLC or other pair-gain technology necessarily uses the interfaced approach. The FDI in the interfaced design makes use of a manual cross-connection, typically housed inside an outside plant device ("green box") or in a vault or manhole.

6.1.2 The Distribution may be copper twisted pair, coax cable, single or multi-mode fiber optic cable or other technologies. A combination that includes two (2) or more of these media is also possible.

## **6.2 Requirements for All Distribution**

6.2.1 Subject to the provisions of Section 4.1.1 (above), Distribution shall be capable of transmitting signals for the following services (as requested by MCI):

6.2.1.1 Two-wire & four-wire analog voice grade Loops; and

6.2.1.2 Two-wire & four-wire Loops that are conditioned to transmit the digital signals needed to provide services such as ISDN, ADSL, HDSL, and DS1-level signals.

6.2.2 Distribution shall transmit all signaling messages or tones. Where the Distribution includes any active elements that terminate any of the signaling messages or tones, these messages or tones shall be reproduced by the Distribution at the interfaces to an adjacent Network Element in a format that maintains the integrity of the signaling messages or tones.

6.2.3 Distribution shall support functions associated with provisioning, maintenance and testing of the Distribution itself.

6.2.4 Where possible, Distribution shall provide Performance monitoring of the Distribution itself, as well as provide necessary access for Performance monitoring for Network Elements to which it is associated.

6.2.5 Distribution shall be equal to or better than all of the applicable requirements set forth in the following technical references:

6.2.5.1 Bellcore TR-TSY-000057, "Functional Criteria for Digital Loop Carrier Systems"; and

6.2.5.2 Bellcore TR-NWT-000393, "Generic Requirements for ISDN Basic Access Digital Subscriber Lines."

6.2.6 Sprint shall offer Distribution together or separately from the NID.

### **6.3 Additional Requirements for Special Copper Distribution**

In addition to Distribution that supports the requirements in Section 6.2 (above), upon MCI's request and at its expense, Sprint will provide Distribution to be a copper twisted pair which are unfettered by any intervening equipment (e.g., filters, load coils, range extenders) so that MCI can use these Loops for a variety of services than can only be supported by use of copper by attaching appropriate terminal equipment at the ends. If such facilities do not exist, MCI may order special construction at MCI's expense.

### **6.4 Additional Requirements for Fiber Distribution**

Fiber optic cable Distribution shall be capable of transmitting signals for the following Telecommunications Services in addition to the ones under Section 6.2.1 above:

6.4.1 DS3 rate private line service;

6.4.2 Optical SONET OC-N rate private lines (where N is defined in the technical reference in Subsection 4.4.1.2.4); and

6.4.3 Analog Radio Frequency based services.

### **6.5 [INTENTIONALLY LEFT BLANK]**

### **6.6 Interface Requirements**

6.6.1 Signal transfers between the Distribution and the NID and an adjacent Network Element shall have levels of degradation that are within the Performance requirements set forth in Section 15.2 of this Attachment III.

6.6.2 Distribution shall be equal to or better than each of the applicable interface requirements set forth in the following technical references:



6.6.2.1 Bellcore TR-NWT-000049, "Generic Requirements for Outdoor Telephone Network Interface Devices," Issued December 1, 1994;

6.6.2.2 Bellcore TR-NWT-000057, "Functional Criteria for Digital Loop Carrier Systems," Issued January 2, 1993;

6.6.2.3 Bellcore TR-NWT-000393, "Generic Requirements for ISDN Basic Access Digital Subscriber Lines"; and

6.6.2.4 Bellcore TR-NWT-000253, SONET Transport Systems: Common Criteria (A module of TSGR, FR-NWT-000440), Issue 2, December 1991.

## **Section 7. Local Switching**

### **7.1 Definition**

7.1.1 Local Switching is the Network Element that provides the functionality required to connect the appropriate lines or trunks wired to the Main Distributing Frame ("MDF") or Digital Cross Connect ("DSX") panel to a desired line or trunk. The desired connection path for each call type will vary by subscriber and will be specified by MCI as a routing scenario that will be implemented in advance as part of or after the purchases of the unbundled Local Switching. Such functionality shall include, all of the features, functions, and capabilities that the underlying Sprint Switch that is providing such Local Switching function is capable of providing, which may include, but is not limited to: line signaling and signaling software; digit reception; dialed number translations; call screening; routing; recording; call supervision; dial tone; switching; telephone number provisioning; announcements; calling features and capabilities (including call processing); CENTREX or CENTREX-like services; Automatic Call Distributor ("ACD"); Carrier pre-subscription (e.g., long distance carrier, IntraLATA toll); Carrier Identification Code ("CIC") portability capabilities; testing; and other operational features inherent to the Switch and Switch software. It also provides access to transport, signaling (ISDN User Part ("ISUP")) and Transaction Capabilities Application Part ("TCAP"), and platforms such as adjuncts, Public Safety Systems ("911"), Operator Services, directory services and Advanced Intelligent Network ("AIN"). Remote Switching Module functionality is included in the Local Switching function. Local Switching may also be capable of routing local, IntraLATA, InterLATA, calls to

international subscriber's preferred carrier, call features (e.g., call forwarding) and CENTREX capabilities.

7.1.2 Local Switching, including the ability to route to MCI's transport facilities, dedicated facilities and systems, shall be unbundled from all other unbundled Network Elements (i.e., Operator Systems, Common Transport, and Dedicated Transport).

## **7.2. Technical Requirements**

7.2.1 Local Switching shall be equal to or better than the requirements for Local Switching set forth in Bellcore's Local Switching Systems General Requirements (FR-NWT-000064).

7.2.1.1 Sprint shall route calls to the appropriate trunk or lines for call origination or termination.

7.2.1.2 Sprint shall route calls on a per line or per screening class basis to: (1) Sprint platforms providing Network Elements or additional requirements; (2) MCI-designated platforms; or (3) third party platforms.

7.2.1.3 Sprint shall provide its standard unbranded recorded announcements (as designated by MCI) and call progress tones to alert callers of call progress and disposition. MCI will use the BFR process for unique announcements.

7.2.1.4 Sprint shall change a subscriber from Sprint's Telecommunications Services to MCI's Telecommunications Services without loss of feature functionality unless expressly agreed otherwise by MCI.

7.2.1.5 Sprint shall perform routine testing (e.g., Mechanized Loop Tests ("MLT") and test calls such as 105, 107 and 108 type calls) and fault isolation on a schedule mutually agreed by the Parties.

7.2.1.6 Sprint shall repair and restore any equipment or any other maintainable component that may adversely impact Local Switching.

7.2.1.7 Sprint shall control congestion points such as mass calling events, and network routing abnormalities, using capabilities such as automatic call gapping, automatic congestion control, and network routing overflow.

Application of such control shall be competitively neutral and not favor any user of unbundled switching or Sprint.

7.2.1.8 Sprint shall perform manual call trace as designated by MCI and permit subscriber originated call trace in accordance with Section 6.5, Attachment VIII.

7.2.1.9 Sprint shall record all billable events (consistent with the billable events typically recorded by Sprint), involving usage of the element, and send the appropriate recording data to MCI as outlined in Attachment VIII.

7.2.1.10 For Local Switching used as 911 Tandems, Sprint shall allow interconnection from MCI Local Switching elements and Sprint shall route the calls to the appropriate Public Safety Access Point ("PSAP").

7.2.1.11 Where Sprint provides the following special services, it shall provide to MCI:

7.2.1.11.1 Essential service lines;

7.2.1.11.2 Telephone service prioritization;

7.2.1.11.3 Related services for handicapped;

7.2.1.11.4 Soft dial tone where required by law; and

7.2.1.11.5 Any other service required by law or regulation.

7.2.1.12 Sprint shall provide Switching Service Point ("SSP") capabilities and signaling software to interconnect the signaling links destined to the Signaling Transfer Point Switch ("STPs"). In the event that Local Switching is provided out of a Switch without SS7 capability, where Sprint provides the Tandem, such Tandem shall provide this capability as discussed in the Section on Tandem Switching. These capabilities shall adhere to Bellcore specifications TCAP (GR-1432-CORE), ISUP (GR-905-CORE), Call Management (GR-1429-CORE), Switched Fractional DS1 (GR-1357-CORE), Toll Free Service (GR-1428-CORE), Calling Name (GR-1597-CORE), Line Information Database (GR-954-CORE), and Advanced Intelligent Network (GR-2863-CORE).

7.2.1.13 Sprint shall at MCI's expense provide interfaces to MCI adjuncts through industry standard interfaces. These adjuncts can include, but are not limited to, Service Node, Service Circuit Node, Voice Mail and Automatic Call Distributors. Examples of existing interfaces are ANSI ISDN standards Q.931 and Q.932.

7.2.1.14 Sprint shall provide Performance data regarding a subscriber line, traffic characteristics or other measurable elements to MCI, upon MCI's request.

7.2.1.15 Sprint shall offer all Local Switching features that are Technically Feasible and provide feature offerings at Parity to those provided by Sprint to itself or any other party. Such feature offerings may include, but are not limited to:

7.2.1.15.1 Basic and primary rate ISDN;

7.2.1.15.2 Residential features;

7.2.1.15.3 Custom Local Area Signaling Services ("CLASS/LASS");

7.2.1.15.4 Custom Calling Features;

7.2.1.15.5 CENTREX (including equivalent administrative capabilities, such as subscriber accessible reconfiguration and detailed message recording); and

7.2.1.15.6 Advanced intelligent network triggers supporting MCI, and Sprint service applications, in Sprint's SCPs. Sprint shall offer to MCI all AIN triggers currently available to Sprint for offering AIN-based services in accordance with applicable technical references:

7.2.1.15.6.1 Off-hook immediate;

7.2.1.15.6.2 Off-hook delay;

7.2.1.15.6.3 Private EAMF trunk;

7.2.1.15.6.4 Shared interoffice trunk (EAMF, SS7);

7.2.1.15.6.5 Termination attempt;

7.2.1.15.6.6 3/6/10 digit screening;

7.2.1.15.6.7 N11;

7.2.1.15.6.8 Feature code dialing;

7.2.1.15.6.9 Custom dialing plan(s) including 555 services; and

7.2.1.15.6.10 Automatic route selection.

**7.2.1.16 Subject to the Technically Feasible capacity limitations of the Sprint Switch, Sprint shall assign each MCIIm subscriber line the class of service designated by MCIIm (e.g., using line class codes or other Switch specific provisioning methods), and shall route calls from MCIIm subscribers as directed by MCIIm at MCIIm's option. This includes each of the following call types:**

7.2.1.16.1 O+/O- calls;

7.2.1.16.2 911 calls;

7.2.1.16.3 411/DA calls;

7.2.1.16.4 InterLATA calls specific to PIC or regardless of PIC (e.g., 10XXX), as applicable;

7.2.1.16.5 IntraLATA calls specific to PIC or regardless of PIC (e.g., 10xxx), as applicable;

7.2.1.16.6 800/888 calls, prior to database query;

7.1.2.16.7 Call forwarding of any type supported on the Switch, to a line or trunk;

7.1.2.16.8 Any other customized routing that may be supported by the Sprint Switch.

**7.2.1.17 If an MCIIm subscriber subscribes to MCIIm provided voice mail and messaging services, Sprint shall redirect incoming calls to the MCIIm system based upon presubscribed service arrangements (e.g., busy, don't**

answer, number of rings). In addition, Sprint shall provide a Standard Message Desk Interface-Enhanced ("SMDI-E") interface to the MCI system. Sprint shall support the Inter-Switch Voice Messaging Service ("IVMS") capability.

7.2.1.18 Local Switching shall be offered in accordance with the requirements of the following technical references and their future releases:

7.2.1.18.1 GR-1298-CORE, AIN Switching System Generic Requirements;

7.2.1.18.2 GR-1299-CORE, AIN Switch-Service Control Point ("SCP")/Adjunct Interface Generic Requirements;

7.2.1.18.3 TR-NWT-001284, AIN 0.1 Switching System Generic Requirements;

7.2.1.18.4 SR-NWT-002247, AIN Release 1 Update.

## 7.2.2 Interface Requirements

7.2.2.1 Sprint shall provide the following interfaces to Loops:

7.2.2.1.1 Standard Tip/Ring interface, including loopstart or groundstart, on-hook signaling (e.g., for calling number, calling name and message waiting lamp);

7.2.2.1.2 Coin phone signaling;

7.2.2.1.3 Basic Rate Interface ISDN adhering to ANSI standards Q.931, Q.932 and appropriate Bellcore Technical Requirements;

7.2.2.1.4 Two-wire analog interface to PBX to include reverse battery, E&M, wink start and DID;

7.2.2.1.5 Four-wire analog interface to PBX to include reverse battery, E&M, wink start and DID;

7.2.2.1.6 Four-wire DS1 interface to PBX or subscriber provided equipment (e.g., computers and voice response systems);

7.2.2.1.7 Primary Rate ISDN to PBX adhering to ANSI standards Q.931, Q.932 and appropriate Bellcore Technical Requirements;

7.2.2.1.8 Switched Fractional DS1 with capabilities to configure Nx64 channels (where N = 1 to 24); and

7.2.2.1.9 Loops adhering to Bellcore TR-NWT-08 and TR-NWT-303 specifications to interconnect Digital loop carriers.

7.2.2.2 Sprint shall provide access to interfaces, including, but not limited to:

7.2.2.2.1 SS7 Signaling Network, Dial Plus or Multi-Frequency trunking if requested by MCI/m;

7.2.2.2.2 Interface to MCI/m Operator Services Systems or Operator Services through appropriate trunk interconnections for the system; and

7.2.2.2.3 Interface to MCI/m Directory Assistance Services through the MCI/m switched network or to Directory Services through the appropriate trunk interconnections for the system, and 950 access or other MCI/m required access to Interexchange Carriers as requested through appropriate trunk interfaces.

### **7.3 Integrated Services Digital Network ("ISDN")**

7.3.1 Sprint shall provide MCI/m Integrated Services Digital Network ("ISDN") services where it is available. ISDN is defined in two variations. The first variation is Basic Rate ISDN ("BRI"). BRI consists of two (2) Bearer (B) Channels and one (1) Data (D) Channel. The second variation is Primary Rate ISDN ("PRI"). PRI consists of twenty-three (23) B Channels and one (1) D Channel. Both BRI and PRI B Channels may be used for voice, Circuit Switched Data ("CSD") or Packet Switched Data ("PSD"). The BRI D Channel may be used for call-related signaling, noncall-related

signaling or packet Switched data. The PRI D Channel may be used for call-related signaling.

### **7.3.2 Technical Requirements — ISDN**

7.3.2.1 Sprint shall offer Data Switching providing ISDN that, at a minimum:

7.3.2.1.1 Provides integrated Packet handling capabilities;

7.3.2.1.2 Allows for full 2B+D Channel functionality for BRI;

7.3.2.1.3 Allows for full 23B+D Channel functionality for PRI;

7.3.2.1.4 Each B Channel shall allow for voice, 64 Kbps CSD, and PSD of one hundred twenty-eight (128) logical channels at minimum speeds of 19 Kbps throughput of each logical channel up to the total capacity of the B Channel;

7.3.2.1.5 Each B Channel shall provide capabilities for alternate voice and data on a per call basis;

7.3.2.1.6 The BRI D Channel shall allow for call-associated signaling, noncall-associated signaling and PSD of sixteen (16) logical channels at minimum speeds of 9.6 Kbps throughput of each logical channel up to the total capacity of the D channel; and

7.3.2.1.7 The PRI D Channel shall allow for call-associated signaling.

### **7.3.3 Interface Requirements — ISDN**

7.3.3.1 Sprint shall provide the BRI U interface using two-wire copper Loops in accordance with TR-NWT-000393, January 1991, Generic Requirements for ISDN Basic Access Digital Subscriber Lines.

7.3.3.2 Sprint shall provide the BRI interface using Digital Subscriber Loops adhering to Bellcore TR-NWT-303 specifications to interconnect Digital Loop Carriers.



7.3.3.3 Sprint shall offer PSD interfaces adhering to the X.25, X.75 and X.75' ANSI and Bellcore requirements.

7.3.3.4 Sprint shall offer PSD trunk interfaces operating at 56 Kbps.

## **Section 8. Operator Systems**

See Attachment VIII, Section 6.1.2 Directory Assistance Service and 6.1.3 Operator Service.

## **Section 9. Common Transport**

### **9.1 Definition**

Common Transport is an interoffice transmission path between Sprint Network Elements (illustrated in Figure 2) shared by carriers. Where Sprint Network Elements are connected by intra-office wiring, such wiring is provided as a part of the Network Elements and is not Common Transport. Sprint shall offer Common Transport as of the Approval Date of this Agreement, at DS0, DS1, DS3, STS-1 or higher transmission bit rate circuits. Common Transport consists of Sprint interoffice transport facilities and is distinct and separate from Local Switching.

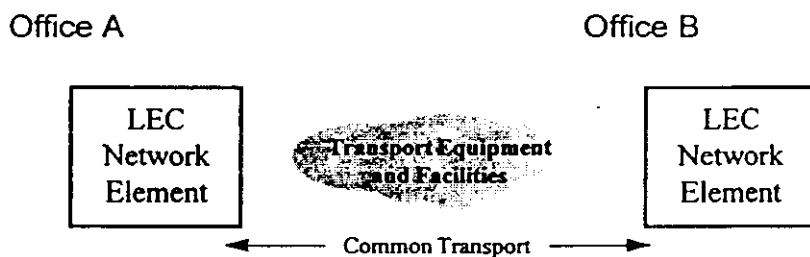

**Figure 2**

### **9.2 Technical Requirements**

9.2.1 Sprint shall be responsible for the engineering, provisioning, and maintenance of the underlying equipment and facilities that are used to provide Common Transport.

9.2.2 At a minimum, Common Transport shall meet all of the requirements set forth in the following technical references (as applicable for the transport technology being used):

9.2.2.1 ANSI T1.101-1994, American National Standard for Telecommunications - Synchronization Interface Standard Performance and Availability;

9.2.2.2 ANSI T1.102-1993, American National Standard for Telecommunications - Digital Hierarchy - Electrical Interfaces;

9.2.2.3 ANSI T1.102.01-199x, American National Standard for Telecommunications - Digital Hierarchy - VT1.5;

9.2.2.4 ANSI T1.105-1995, American National Standard for Telecommunications - Synchronous Optical Network ("SONET") - Basic Description including Multiplex Structure, Rates and Formats;

9.2.2.5 ANSI T1.105.01-1995, American National Standard for Telecommunications - Synchronous Optical Network ("SONET") Automatic Protection Switching;

9.2.2.6 ANSI T1.105.02-1995, American National Standard for Telecommunications - Synchronous Optical Network ("SONET") - Payload Mappings;

9.2.2.7 ANSI T1.105.03-1994, American National Standard for Telecommunications - Synchronous Optical Network ("SONET") - Jitter at Network Interfaces;

9.2.2.8 ANSI T1.105.03a-1995, American National Standard for Telecommunications - Synchronous Optical Network ("SONET") - Jitter at Network Interfaces - DS1 Supplement;

9.2.2.9 ANSI T1.105.05-1994, American National Standard for Telecommunications - Synchronous Optical Network ("SONET") - Tandem Connection;

9.2.2.10 ANSI T1.105.06-199x, American National Standard for Telecommunications - Synchronous Optical Network ("SONET") - Physical Layer Specifications;

9.2.2.11 ANSI T1.105.07-199x, American National Standard for Telecommunications - Synchronous Optical Network ("SONET") - Sub STS-1 Interface Rates and Formats;

9.2.2.12 ANSI T1.105.09-199x, American National Standard for Telecommunications - Synchronous Optical Network ("SONET") - Network Element Timing and Synchronization;

9.2.2.13 ANSI T1.106-1988, American National Standard for Telecommunications - Digital Hierarchy - Optical Interface Specifications (Single Mode);

9.2.2.14 ANSI T1.107-1988, American National Standard for Telecommunications - Digital Hierarchy - Formats Specifications;

9.2.2.15 ANSI T1.107a-1990 -American National Standard for Telecommunications - Digital Hierarchy - Supplement to Formats Specifications (DS3 Format Applications);

9.2.2.16 ANSI T1.107b-1991 - American National Standard for Telecommunications - Digital Hierarchy - Supplement to Formats Specifications;

9.2.2.17 ANSI T1.117-1991, American National Standard for Telecommunications - Digital Hierarchy - Optical Interface Specifications ("SONET") (Single Mode - Short Reach);

9.2.2.18 ANSI T1.403-1989, Carrier to Subscriber Installation, DS1 Metallic Interface Specification;

9.2.2.19 ANSI T1.404-1994, Network-to-Subscriber Installation - DS3 Metallic Interface Specification;

9.2.2.20 ITU Recommendation G.707, Network node interface for the synchronous digital hierarchy ("SDH");

9.2.2.21 ITU Recommendation G.704, Synchronous frame structures used at 1544, 6312, 2048, 8488 and 44736 kbit/s hierarchical levels;

9.2.2.22 Bellcore FR-440 and TR-NWT-000499, Transport Systems Generic Requirements ("TSGR"), Common Requirements;

9.2.2.23 Bellcore GR-820-CORE, Generic Transmission Surveillance, DS1 & DS3 Performance;

9.2.2.24 Bellcore GR-253-CORE, Synchronous Optical Network Systems ("SONET"), Common Generic Criteria;

9.2.2.25 Bellcore TR-NWT 000507, Transmission, Section 7, Issue 5 (Bellcore, December 1993) (A module of LSSGR, FR-NWT-000064);

9.2.2.26 Bellcore TR-NWT-000776, Network Interface Description for ISDN Subscriber Access;

9.2.2.27 Bellcore TR-INS-000342, High-Capacity Digital Special Access Service-Transmission Parameter Limits and Interface Combinations, Issue 1, February 1991;

9.2.2.28 Bellcore ST-TEC-000052, Telecommunications Transmission Engineering Textbook, Volume 2, Facilities, Third Edition, Issue I, May 1989; and

9.2.2.29 Bellcore ST-TEC-000051, Telecommunications Transmission Engineering Textbook Volume 1, Principles, Third Edition, Issue 1, August 1987.

## **Section 10. Dedicated Transport**

### **10.1 Definition**

10.1.1 Dedicated Transport is an interoffice transmission path between MCI designated locations to which MCI is granted exclusive use. As mutually agreed by the Parties, such locations may include Sprint Central Offices or other locations, MCI network components, or other carrier network components. Dedicated Transport is depicted below in Figure 3.



**Figure 3**

10.1.2 Where technically feasible and available, Sprint shall offer Dedicated Transport consistent with the underlying technology as follows:

10.1.2.1 As a circuit (e.g., DS1, DS3, STS-1) dedicated to MCI<sub>m</sub>.

10.1.2.2 As a system (i.e., the equipment and facilities used to provide Dedicated Transport such as SONET ring) dedicated to MCI<sub>m</sub>.

10.1.3 When Dedicated Transport is provided as a circuit, it shall include appropriate:

10.1.3.1 Multiplexing functionality;

10.1.3.2 Grooming functionality; and

10.1.3.3 Redundant equipment and facilities necessary to support protection and restoration.

10.1.4 When Dedicated Transport is provided as a system it shall include:

10.1.4.1 Transmission equipment such as multiplexers, line terminating equipment, amplifiers, and regenerators;

10.1.4.2 Inter-office transmission facilities such as optical fiber, or copper twisted pair;

10.1.4.3 Redundant equipment and facilities necessary to support protection and restoration; and

10.1.4.4 Dedicated Transport includes the Digital Cross-Connect System ("DCS") functionality as an option. DCS is described below in Section 10.5.

## 10.2 Technical Requirements

This Section sets forth technical requirements for all Dedicated Transport.

10.2.1 When Sprint provides Dedicated Transport as a circuit or a system, the entire designated transmission circuit or system (e.g., DS1, DS3, STS-1) shall be dedicated to MCI<sub>m</sub> designated traffic.

10.2.2 Where Sprint has the technology available, Sprint shall offer Dedicated Transport using currently available technologies including, but not limited to, DS1 and DS3 transport systems, SONET (or SDH) Bi-directional Line Switched Rings, SONET (or SDH) Unidirectional Path Switched Rings, and SONET (or SDH) point-to-point transport systems (including linear add-drop systems), at all available transmission bit rates.

10.2.3 When requested by MCI, Dedicated Transport shall provide physical diversity. Physical diversity means that two (2) circuits are provisioned in such a way that no single failure of facilities or equipment will cause a failure on both circuits.

10.2.4 When physical diversity is requested by MCI, Sprint shall provide the maximum feasible physical separation between transmission paths for all facilities and equipment, unless otherwise agreed by MCI.

10.2.5 Upon MCI's request, where permitted by Sprint's current systems (as upgraded by Sprint from time to time) or subject to vendor development that will allow such functionality and that will include necessary security features, Sprint shall provide Real Time and continuous remote access to Performance monitoring and alarm data affecting, or potentially affecting, MCI's traffic on Dedicated Transport systems. Where System development is required, Sprint agrees to work with its vendors to facilitate development.

10.2.6 Sprint shall offer the following interface transmission rates for Dedicated Transport:

10.2.6.1 DS1 (Extended SuperFrame - ESF/B8ZS, D4, and unframed applications shall be provided);

10.2.6.2 DS3 (C-bit Parity, M13, and unframed applications shall be provided);

10.2.6.3 SONET standard interface rates in accordance with ANSI T1.105 and ANSI T1.105.07 and physical interfaces per ANSI T1.106.06, including referenced interfaces. In particular, VT1.5 based STS-1s will be the interface at an MCI service node; and

10.2.6.4 SDH Standard interface rates in accordance with International Telecommunications Union ("ITU")

Recommendation G.707 and Plesiochronous Digital Hierarchy ("PDH") rates per ITU Recommendation G.704.

10.2.7 Sprint shall provide cross-office wiring up to a suitable Point of Termination ("POT") between Dedicated Transport and MCI<sub>m</sub> designated equipment. Sprint shall provide the following equipment for the physical POT:

10.2.7.1 DSX1 for DS1s or VT1.5s;

10.2.7.2 DSX3 for DS3s or STS-1s; and

10.2.7.3 LGX for optical signals (e.g., OC-3 and OC-12).

10.2.8 Sprint shall provide physical access to the POT for personnel designated by MCI<sub>m</sub> (for testing, facility interconnection, and other purposes designated by MCI<sub>m</sub>) twenty-four (24) hours a day, seven (7) days a week.

10.2.9 For Dedicated Transport provided as a system, Sprint shall design the system (including, but not limited to, facility routing and termination points) according to MCI<sub>m</sub> specifications, excluding vendor specific equipment. Sprint shall provide MCI<sub>m</sub> with a list of approved equipment vendors. The Parties shall cooperate with each other when vendor compatibility is an issue.

10.2.10 Upon MCI<sub>m</sub>'s request, Sprint shall provide MCI<sub>m</sub> with electronic provisioning control of an MCI<sub>m</sub> specified Dedicated Transport system.

10.2.11 Sprint shall offer Dedicated Transport together with and separately from DCS.

### **10.3 Technical Requirements for Dedicated Transport Using SONET Technology**

This Section sets forth additional technical requirements for Dedicated Transport using SONET technology including rings, point-to-point systems, and linear add-drop systems.

10.3.1 All SONET Dedicated Transport provided as a system shall:

10.3.1.1 Be synchronized from both a primary and secondary Stratum 1 level timing source;

10.3.1.2 Provide SONET standard interfaces which properly interwork with SONET standard equipment from other vendors. This includes, but is not limited to, SONET standard Section, Line and Path Performance monitoring, maintenance signals, alarms, and data channels;

10.3.1.3 Provide Data Communications Channel ("DCC") or equivalent connectivity through the SONET transport system. Dedicated Transport provided over a SONET transport system shall be capable of routing DCC messages between MCI and SONET network components connected to the Dedicated Transport. For example, if MCI leases a SONET ring from Sprint, that ring shall support DCC message routing between MCI and SONET network components connected to the ring.

10.3.1.14 As current equipment (as upgraded from time to time) allows, support the following Performance requirements for each circuit (STS-1, DS1, DS3, etc.):

10.3.1.14.1 No more than ten (10) Errored Seconds Per Day (Errored Seconds are defined in the technical reference at Section 10.4.5); and

10.3.1.14.2 No more than one (1) Severely Errored Second Per Day (Severely Errored Seconds are defined in the technical reference at Section 10.4.5).

10.3.2 SONET rings shall:

10.3.2.1 Be provisioned on physically diverse fiber optic cables (including separate building entrances where available and diversely routed intraoffice wiring). "Diversely routed" shall be interpreted as the maximum feasible physical separation between transmission paths, unless otherwise agreed by MCI;

10.3.2.2 Support dual ring interworking per SONET Standards;

10.3.2.3 Provide the necessary redundancy in optics, electronics, and transmission paths (including intra-office wiring) such that no single failure will cause a service interruption;



10.3.2.4 Provide the ability to disable ring protection switching at MCI's direction (selective protection lock-out). This requirement applies to line Switched rings only;

10.3.2.5 Provide the ability to use the protection channels to carry traffic (extra traffic). This requirement applies to line Switched rings only;

10.3.2.6 Provide fifty (50) millisecond restoration unless a ring protection delay is set to accommodate dual ring interworking schemes;

10.3.2.7 Have settable ring protection switching thresholds that shall be set in accordance with MCI's specifications;

10.3.2.8 Provide revertive protection switching with a settable wait to restore delay with a default setting of five (5) minutes. This requirement applies to line switched rings only, excluding sub-tending rings;

10.3.2.9 Provide non-revertive protection switching. This requirement applies to path switched rings only; and

10.3.2.10 Adhere to the following availability requirements, where availability is defined in the technical reference set forth in Section 10.4.5:

10.3.2.10.1 No more than 0.25 minutes of unavailability per month; and

10.3.2.10.2 No more than 0.5 minutes of unavailability per year.

10.4 At a minimum, Dedicated Transport shall meet each of the requirements set forth in Section 9.2.2 and in the following technical references:

10.4.1 ANSI T1.105.04-1995, American National Standard for Telecommunications - Synchronous Optical Network ("SONET") - Data Communication Channel Protocols and Architectures;

10.4.2 ANSI T1.119-1994, American National Standard for Telecommunications - Synchronous Optical Network ("SONET") - Operations, Administration, Maintenance, and Provisioning ("OAM&P") Communications;

10.4.3 ANSI T1.119.01-1995, American National Standard for Telecommunications - Synchronous Optical Network ("SONET") Operations, Administration, Maintenance, and Provisioning ("OAM&P") Communications Protection Switching Fragment;

10.4.4 ANSI T1.119.02-199x, American National Standard for Telecommunications - Synchronous Optical Network ("SONET") Operations, Administration, Maintenance, and Provisioning ("OAM&P") Communications Performance Monitoring Fragment; and

10.4.5 ANSI T1.231-1993, American National Standard for Telecommunications - Digital Hierarchy - Layer 1 In-Service Digital Transmission Performance Monitoring.

## 10.5 Digital Cross-Connect System ("DCS")

### 10.5.1 Definition

10.5.1.1 DCS is a function which provides automated cross-connection of Digital Signal level 0 ("DS0") or higher transmission bit rate digital channels within physical interface facilities. Types of DCSs include, but are not limited to, DCS 1/0s, DCS 3/1s, and DCS 3/3s, where the nomenclature 1/0 denotes interfaces typically at the DS1 rate or greater with cross-connection typically at the DS0 rate. This same nomenclature, at the appropriate rate substitution, extends to the other types of DCSs specifically cited as 3/1 and 3/3. Types of DCSs that cross-connect Synchronous Transport Signal level 1 (STS-1s) or other Synchronous Optical Network ("SONET") signals (e.g., STS-3) are also DCSs, although not denoted by this same type of nomenclature. DCS may provide the functionality of more than one of the aforementioned DCS types (e.g., DCS 3/3/1 which combines functionality of DCS 3/3 and DCS 3/1). For such DCSs, the requirements will be, at least, the aggregation of requirements on the "component" DCSs.

10.5.1.2 In locations where automated cross-connection capability does not exist, DCS will be defined as the combination of the functionality provided by a Digital Signal Cross-Connect ("DSX") or Light Guide Cross-Connect ("LGX") patch panels and D4 channel banks or other DS0 and above multiplexing equipment used to provide the function of a manual cross-connection.

10.5.1.3 Interconnection between a DSX or LGX, to a Switch, another cross-connect, or other service platform device within the premises where the DSX or LGX is located, is included as part of DCS.

## **10.6 DCS Technical Requirements**

10.6.1 DCS shall provide completed end-to-end cross-connection of the channels designated by MCIIm.

10.6.2 DCS shall perform facility grooming, multipoint bridging, one-way broadcast, two-way broadcast, and facility test functions.

10.6.3 DCS shall provide multiplexing, format conversion, signaling conversion, or other functions.

10.6.4 The end-to-end cross-connection assignment shall be input to the underlying device used to provide DCS from an operator at a terminal or via an intermediate system. The cross-connection assignment shall remain in effect whether or not the circuit is in use.

10.6.5 MCIIm will negotiate with Sprint relating to the administration and maintenance of DCS, including updates to the control software to current available releases.

10.6.6 Sprint shall provide various types of Digital Cross-Connect Systems including:

10.6.6.1 DS0 cross-connects (typically termed DCS 1/0);

10.6.6.2 DS1/VT1.5 (Virtual Tributaries at the 1.5/Mbps rate) cross-connects (typically termed DCS 3/1);

10.6.6.3 DS3 cross-connects (typically termed DCS 3/3);

10.6.6.4 STS-1 cross-connects; and

10.6.6.5 Other Technically Feasible cross-connects designated by MCIIm.

10.6.7 Sprint shall provide immediate and continuous configuration and reconfiguration of the channels between the physical interfaces (*i.e.*, Sprint shall establish the process to implement cross-connects on demand, or, at MCI's option, permit MCI control of such configurations and reconfigurations), where permitted by Sprint's current systems (as upgraded by Sprint from time to time) or subject to vendor development that will allow such functionality and that will include necessary security features. Where system development is required, Sprint agrees to work with its vendors to facilitate development.

10.6.8 Sprint shall provide scheduled configuration and reconfiguration of the channels between the physical interfaces (*i.e.*, Sprint shall establish the process to implement cross-connects on the schedule mutually agreed upon by the Parties or, at MCI's option, permit MCI to control such configurations and reconfigurations), where permitted by Sprint's current systems (as upgraded by Sprint from time to time) or subject to vendor development that will allow such functionality and that will include necessary security features. Where system development is required, Sprint agrees to work with its vendors to facilitate development.

10.6.9 DCS shall continuously monitor protected circuit packs and redundant common equipment.

10.6.10 DCS shall automatically Switch to a protection circuit pack on detection of a failure or degradation of normal operation.

10.6.11 The underlying equipment used to provide DCS shall be equipped with a redundant power supply or a battery back-up.

10.6.12 Sprint shall have available spare facilities and equipment necessary for provisioning repairs in order to meet MCI's maintenance standards as specified in the Provisioning and Maintenance Sections.

10.6.13 At MCI's option, where permitted by Sprint's current systems (as upgraded by Sprint from time to time) or subject to vendor development that will allow such functionality and that will include necessary security features, Sprint shall provide MCI with Real Time Performance monitoring and alarm data on the signals and the components of the underlying equipment used to provide DCS that actually impact or might impact MCI's services. For example, this may include hardware alarm data and facility alarm

data on a DS3 in which an MCI DS1 is traversing. Where system development is required, Sprint agrees to work with its vendors to facilitate development.

10.6.14 At MCI's option, where permitted by Sprint's current systems (as upgraded by Sprint from time to time) or subject to vendor development that will allow such functionality and that will include necessary security features, Sprint shall provide MCI with Real Time ability to initiate tests on integrated equipment used to test the signals and the underlying equipment used to provide DCS, as well as other integrated functionality for routine testing and fault isolation. Where system development is required, Sprint agrees to work with its vendors to facilitate development.

10.6.15 Where permitted by Sprint's current systems (as upgraded by Sprint from time to time), DCS shall provide SONET to asynchronous Gateway functionality (e.g., STS-1 to DS1 or STS-1 to DS3). Where system development is required, Sprint agrees to work with its vendors to facilitate development.

10.6.16 DCS shall perform optical to electrical conversion where the underlying equipment used to provide DCS contains optical interfaces or terminations (e.g., Optical Carrier level 3, i.e., OC-3, interfaces on a DCS 3/1).

10.6.17 Where permitted by Sprint's current systems (as upgraded by Sprint from time to time), DCS shall have SONET ring terminal functionality where the underlying equipment used to provide DCS acts as a terminal on a SONET ring. Where system development is required, Sprint agrees to work with its vendors to facilitate development.

10.6.18 Where permitted by Sprint's current systems (as upgraded by Sprint from time to time), DCS shall provide multipoint bridging of multiple channels to other DCSs. MCI may designate multipoint bridging to be one-way broadcast from a single master to multiple tributaries, or two-way broadcast between a single master and multiple tributaries. Where system development is required, Sprint agrees to work with its vendors to facilitate development.

10.6.19 Where permitted by Sprint's current systems (as upgraded by Sprint from time to time), DCS shall multiplex lower speed channels onto a higher speed interface and demultiplex higher speed channels onto lower speed interfaces as designated by MCI. Where system development is required, Sprint agrees to work with its vendors to facilitate development.

## 10.7 DCS Interface Requirements

10.7.1 Where permitted by Sprint's current systems (as upgraded by Sprint from time to time), Sprint shall provide physical interfaces on DS0, DS1, and VT1.5 channel cross-connect devices at the DS1 rate or higher. In all such cases, these interfaces shall be in compliance with applicable Bellcore and ANSI standards.

10.7.2 Where permitted by Sprint's current systems (as upgraded by Sprint from time to time), Sprint shall provide physical interfaces on DS3 channel cross-connect devices at the DS3 rate or higher. In all such cases, these interfaces shall be in compliance with applicable Bellcore and ANSI standards.

10.7.3 Where permitted by Sprint's current systems (as upgraded by Sprint from time to time), Sprint shall provide physical interfaces on STS-1 cross-connect devices at the OC-3 rate or higher. In all such cases, these interfaces shall be in compliance with applicable Bellcore and ANSI standards.

10.7.4 Where permitted by Sprint's current systems (as upgraded by Sprint from time to time), interfaces on all other cross-connect devices shall be in compliance with applicable Bellcore and ANSI standards.

10.8 DCS shall, at a minimum, where permitted by Sprint's current systems (as upgraded by Sprint from time to time) meet all the requirements set forth in the following technical references. Where system development is required, Sprint agrees to work with its vendors to facilitate development.

10.8.1 ANSI T1.102-1993, American National Standard for Telecommunications - Digital Hierarchy - Electrical Interfaces;

10.8.2 ANSI T1.102.01-199x, American National Standard for Telecommunications - Digital Hierarchy - VT1.5;

10.8.3 ANSI T1.105-1995, American National Standard for Telecommunications - Synchronous Optical Network ("SONET") - Basic Description including Multiplex Structure, Rates and Formats;

10.8.4 ANSI T1.105.03-1994, American National Standard for Telecommunications - Synchronous Optical Network ("SONET") - Jitter at Network Interfaces;

10.8.5 ANSI T1.105.03a-1995, American National Standard for Telecommunications - Synchronous Optical Network ("SONET") - Jitter at Network Interfaces - DS1 Supplement;

10.8.6 ANSI T1.105.06-199x, American National Standard for Telecommunications - Synchronous Optical Network ("SONET") - Physical Layer Specifications;

10.8.7 ANSI T1.106-1988, American National Standard for Telecommunications - Digital Hierarchy - Optical Interface Specifications (Single Mode);

10.8.8 ANSI T1.107-1988, American National Standard for Telecommunications - Digital Hierarchy - Formats Specifications;

10.8.9 ANSI T1.107a-1990, American National Standard for Telecommunications - Digital Hierarchy - Supplement to Formats Specifications (DS3 Format Applications);

10.8.10 ANSI T1.107b-1991, American National Standard for Telecommunications - Digital Hierarchy - Supplement to Formats Specifications;

10.8.11 ANSI T1.117-1991, American National Standard for Telecommunications - Digital Hierarchy - Optical Interface Specifications ("SONET") (Single Mode - Short Reach);

10.8.12 ANSI T1.403-1989, Carrier to Subscriber Installation, DS1 Metallic Interface Specification;

10.8.13 ANSI T1.404-1994, Network-to-Subscriber Installation - DS3 Metallic Interface Specification;

10.8.14 ITU Recommendation G.707, Network node interface for the synchronous digital hierarchy ("SDH");

10.8.15 ITU Recommendation G.704, Synchronous frame structures used at 1544, 6312, 2048, 8488 and 44736 kbit/s hierarchical levels;

10.8.16 FR-440 and TR-NWT-000499, Transport Systems Generic Requirements ("TSGR"), Common Requirements;

10.8.17 GR-820-CORE, Generic Transmission Surveillance, DS1 & DS3 Performance;

10.8.18 GR-253-CORE, Synchronous Optical Network Systems ("SONET"), Common Generic Criteria; and

10.8.19 TR-NWT-000776, Network Interface Description for ISDN Subscriber Access.

## **Section 11. Signaling Link Transport**

### **11.1 Definition**

Signaling Link Transport is a set of two (2) or four (4) dedicated 56 Kbps transmission paths between MCI-designated Signaling Points of Interconnection ("SPOI") that provides appropriate physical diversity and a cross-connect at an Sprint STP site.

### **11.2 Technical Requirements**

11.2.1 Signaling Link Transport shall consist of full duplex mode 56 Kbps transmission paths.

11.2.2 Of the various options available, Signaling Link Transport shall perform in the following two ways:

11.2.2.1 As an "A-link" which is a connection between a Switch or SCP and a home Signaling Transfer Point Switch ("STPs") pair; and

11.2.2.2 As a "D-link" which is a connection between two (2) STPs pairs in different company networks (e.g., between two STPs pairs for two (2) Competitive Local Exchange Carriers ("CLECs")).

11.2.3 Signaling Link Transport shall consist of one (1) or more signaling link layers as follows:

11.2.3.1 An A-link layer shall consist of two (2) links.

11.2.3.2 A B or D-link layer shall consist of four (4) links.

11.2.4 A signaling link layer shall satisfy a Performance objective such that:

11.2.4.1 There shall be no more than two (2) minutes unplanned down time per year for an A-link layer, and



11.2.4.2 There shall be negligible (less than two (2) unplanned seconds) down time per year for a D-link layer.

11.2.5 A signaling link layer shall satisfy interoffice and intraoffice diversity of facilities and equipment, such that:

11.2.5.1 No single failure of facilities or equipment causes the failure of both links in an A-link layer (*i.e.*, the links should be provided on a minimum of two (2) separate physical paths end-to-end); and

11.2.5.2 Where available and to the greatest extent possible, no two (2) concurrent failures of facilities or equipment shall cause the failure of all four (4) links in a D-link layer (*i.e.*, the links should be provided on a minimum of three (3) separate physical paths end-to-end).

### **11.3 Interface Requirements**

11.3.1 There shall be a DS1 (1.544 Mbps) interface at the MCIm-designated SPOIs. Each 56 Kbps transmission path shall appear as a DS0 channel within the DS1 interface.

## **Section 12. Signaling Transfer Points (“STPs”)**

### **12.1 Definition**

Signaling Transfer Points (“STPs”) provide functionality that enable the exchange of SS7 messages among and between switching elements, database elements and signaling transfer points. Figure 4 depicts Signaling Transfer Points.

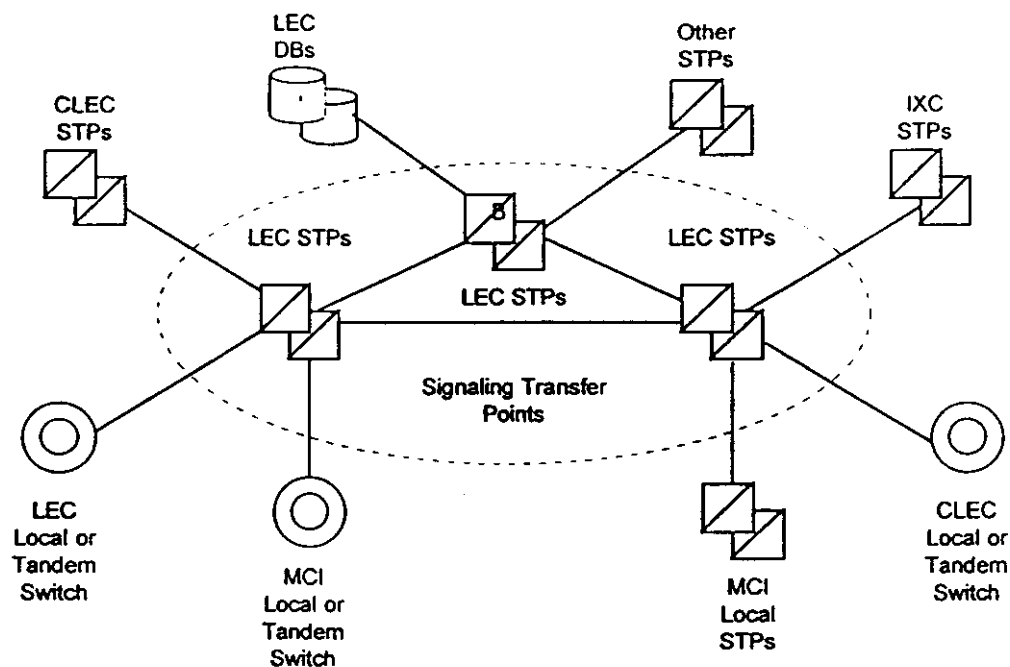

Figure 4

## 12.2 Technical Requirements

12.2.1 STPs shall provide access to all other Network Elements connected to the Sprint SS7 network. These include:

12.2.1.1 Sprint Local Switching or Tandem Switching;

12.2.1.2 Sprint Service Control Points/DataBases;

12.2.1.3 Third party local or tandem switching systems; and

12.2.1.4 Third party-provided STPs.

12.2.2 The connectivity provided by STPs shall fully support the functions of all other Network Elements connected to Sprint's SS7 network. This explicitly includes the use of Sprint's SS7 network to convey messages which either originate or terminate at a signaling end point directly connected to the Sprint SS7 network or which are originated or terminated to a signaling point within the MCI network in conjunction with Sprint's provision of tandem switching

to MCI<sub>m</sub> (*i.e.*, transit messages). When the Sprint SS7 network is used to convey transit messages, there shall be no alteration of the Integrated Services Digital Network User Part ("ISDNUP") or Transaction Capabilities Application Part ("TCAP") user data that constitutes the content of the message.

12.2.3 If a Sprint tandem Switch routes calling traffic, based on dialed or translated digits, on SS7 trunks between an MCI<sub>m</sub> local Switch and third party local Switch, Sprint's SS7 network shall convey the TCAP messages that are necessary to provide Call Management features (Automatic Callback, Automatic Recall, and Screening List Editing) between the MCI<sub>m</sub> local STPs and the STPs that provide connectivity with the third party local Switch, even if the third party local Switch is not directly connected to Sprint's STPs.

12.2.4 STPs shall provide all functions of the MTP as specified in ANSI T1.111 (Reference 12.5.2). This includes:

12.2.4.1 Signaling Data Link functions, as specified in ANSI T1.111.2;

12.2.4.2 Signaling Link functions, as specified in ANSI T1.111.3; and

12.2.4.3 Signaling Network Management functions, as specified in ANSI T1.111.4.

12.2.5 STPs shall provide all functions of the SCCP necessary for Class 0 (basic connectionless) service, as specified in ANSI T1.112 (Reference 12.5.4). In particular, this includes Global Title Translation ("GTT") and SCCP Management procedures, as specified in T1.112.4.

12.2.6 In cases where the destination signaling point is a Sprint local or tandem switching system or database, or is an MCI<sub>m</sub> or third party local or tandem switching system directly connected to Sprint's SS7 network, Sprint STPs shall perform final GTT of messages to the destination and SCCP Subsystem Management of the destination. In all other cases, STPs shall perform intermediate GTT of messages to a Gateway pair of STPs in an SS7 network connected with the Sprint SS7 network, and shall not perform SCCP Subsystem Management of the destination.

12.2.7 STPs shall also provide the capability to route SCCP messages based on ISNI, as specified in ANSI T1.118 (Reference 12.5.7), when this capability becomes available on Sprint STPs.

12.2.8 Where available in both Parties' networks, STPs shall provide all functions of the OMAP commonly provided by STPs, as specified in the reference in Section 12.5.6. This includes:

12.2.8.1 MTP Routing Verification Test ("MRVT"); and

12.2.8.2 SCCP Routing Verification Test ("SRVT").

12.2.9 In cases where the destination signaling point is a Sprint local or tandem switching system or DB, or is an MCIIm or third party local or tandem switching system directly connected to the Sprint SS7 network, STPs shall perform MRVT and SRVT to the destination signaling point. In all other cases, STPs shall perform MRVT and SRVT to a Gateway pair of STPs in an SS7 network connected with the Sprint SS7 network. This requirement shall be superseded by the specifications for Internetwork MRVT and SRVT if and when these become approved ANSI standards and available capabilities of Sprint STPs.

12.2.10 STPs shall be equal to or better than the following Performance requirements:

12.2.10.1 MTP Performance, as specified in ANSI T1.111.6; and

12.2.10.2 SCCP Performance, as specified in ANSI T1.112.5.

### 12.3 Interface Requirements

12.3.1 Sprint shall provide the following STPs options to connect MCIIm or MCIIm-designated Local Switching systems or STPs to the Sprint SS7 network:

12.3.1.1 An A-link interface from MCIIm Local Switching systems; and

12.3.1.2 B or D-link interface from MCIIm STPs.

12.3.2 Each type of interface shall be provided by one or more sets (layers) of signaling links, as follows:

12.3.2.1 An A-link layer shall consist of two (2) links, as depicted in Figure 5.

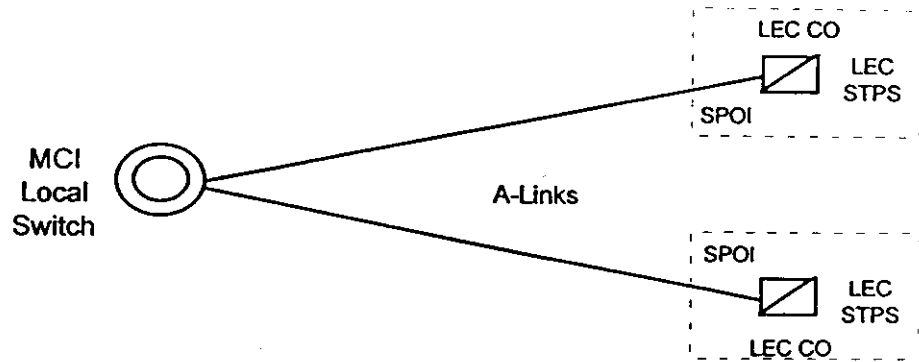

Figure 5. A-Link Interface

12.3.2.2 A B or D-link layer shall consist of four (4) links, as depicted in Figure 6.

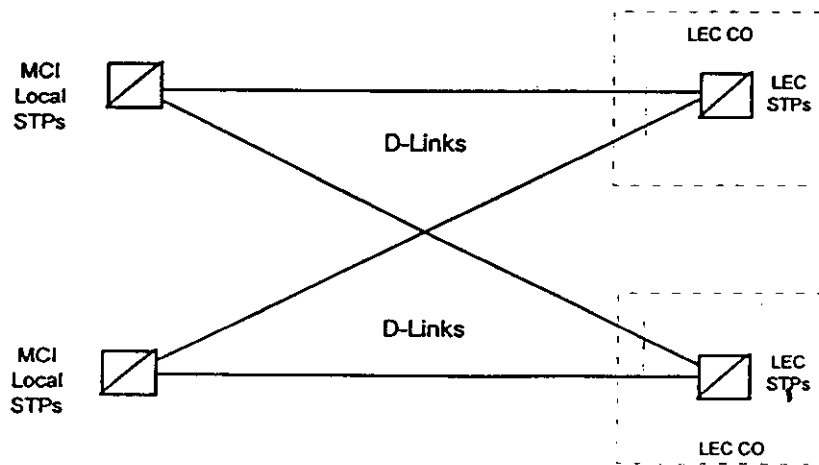

Figure 6. D-Link Interface

12.3.3 The Signaling point of Interconnection ("SPOI") for each link shall be located at a cross-connect element, such as a DSX-1, in the Central Office ("CO") where the Sprint STPs are located. There shall be a DS1 or higher rate transport interface at each of the SPOIs. Each signaling link shall appear as a DS0 channel within the DS1 or higher rate interface. Sprint shall offer higher rate DS1

signaling for interconnecting MCIIm Local Switching systems or STPs with Sprint STPs as soon as these become approved ANSI standards and available capabilities of Sprint STPs.

12.3.4 Where available and to the extent possible, Sprint shall provide MTP and SCCP protocol interfaces that shall conform to all sections relevant to the MTP or SCCP in the following specifications:

12.3.4.1 Bellcore GR-905-CORE, Common Channel Signaling Network Interface Specification ("CCSNIS") Supporting Network Interconnection, Message Transfer Part ("MTP"), and Integrated Services Digital Network User Part ("ISDNUP"); and

12.3.4.2 Bellcore GR-1432-CORE, CCS Network Interface Specification ("CCSNIS") Supporting Signaling Connection Control Part ("SCCP") and Transaction Capabilities Application Part ("TCAP").

## 12.4 Message Screening

12.4.1 Sprint shall set message screening parameters so as to accept messages from MCIIm local or tandem switching systems destined to any signaling point in the Sprint SS7 network with which the MCIIm switching system has a legitimate signaling relation.

12.4.2 Sprint shall set message screening parameters so as to accept messages from MCIIm local or tandem switching systems destined to any signaling point or network interconnected to the Sprint SS7 network with which the MCIIm switching system has a legitimate signaling relation.

12.4.3 Sprint shall set message screening parameters so as to accept messages destined to an MCIIm local or tandem switching system from any signaling point or network interconnected to the Sprint SS7 network with which the MCIIm switching system has a legitimate signaling relation.

12.4.4 Sprint shall set message screening parameters so as to accept and send messages destined to an MCIIm SCP from any signaling point or network interconnected to the Sprint SS7 network with which the MCIIm SCP has a legitimate signaling relation.

## **12.5 STP Requirements**

**12.5.1 STPs shall be equal to or better than all of the requirements for STPs set forth in the following technical references:**

**12.5.2 ANSI T1.111-1992 American National Standard for Telecommunications - Signaling System Number 7 ("SS7") - Message Transfer Part ("MTP");**

**12.5.3 ANSI T1.111A-1994 American National Standard for Telecommunications - Signaling System Number 7 ("SS7") - Message Transfer Part ("MTP") Supplement;**

**12.5.4 ANSI T1.112-1992 American National, Standard for Telecommunications - Signaling System Number 7 ("SS7") - Signaling Connection Control Part ("SCCP");**

**12.5.5 ANSI T1.115-1990 American National Standard for Telecommunications - Signaling System Number 7 ("SS7") - Monitoring and Measurements for Networks;**

**12.5.6 ANSI T1.116-1990 American National Standard for Telecommunications - Signaling System Number 7 ("SS7") - Operations, Maintenance and Administration Part ("OMAP");**

**12.5.7 ANSI T1.118-1992 American National Standard for Telecommunications - Signaling System Number 7 ("SS7") - Intermediate Signaling Network Identification ("ISNI");**

**12.5.8 Bellcore GR-905-CORE, Common Channel Signaling Network Interface Specification ("CCSNIS") Supporting Network Interconnection, Message Transfer Part ("MTP"), and Integrated Services Digital Network User Part ("ISDNUP"); and**

**12.5.9 Bellcore GR-1432-CORE, CCS Network Interface Specification ("CCSNIS") Supporting Signaling Connection Control Part ("SCCP") and Transaction Capabilities Application Part ("TCAP").**

## **Section 13. Service Control Points/Databases**

### **13.1 Definition**

13.1.1 Databases are the Network Elements that provide the functionality for storage of, access to, and manipulation of information required to offer a particular service and/or capability. Databases include, but are not limited to: Number Portability, LIDB, Toll Free Number Database, Automatic Location Identification/Data Management System, and AIN when it is available.

13.1.2 A Service Control Point ("SCP") is a specific type of Database Network Element functionality deployed in a Signaling System 7 ("SS7") network that executes service application logic in response to SS7 queries sent to it by a switching system also connected to the SS7 network. SCPs also provide operational interfaces to allow for provisioning, administration and maintenance of subscriber data and service application data. (e.g., an 800 database stores subscriber record data that provides information necessary to route 800 calls).

### **13.2 Technical Requirements for SCPs/Databases**

Requirements for SCPs/Databases within this Section address storage of information, access to information (e.g., signaling protocols, response times), and administration of information (e.g., provisioning, administration, and maintenance). All SCPs/Databases shall be provided to MCI in accordance with the following requirements, except where such a requirement is superseded by specific requirements set forth in Sections 13.3 through 13.7:

13.2.1 Sprint shall provide physical interconnection to SCPs through the SS7 network and protocols, as specified in Section 12 of this Attachment, with TCAP as the application layer protocol;

13.2.2 Sprint shall provide physical interconnection to databases via industry standard interfaces and protocols (e.g., ISDN and X.25);

13.2.3 The reliability of interconnection options shall be consistent with requirements for diversity and survivability as specified in Section 12 of this Attachment (which applies to both SS7 and non-SS7 interfaces);



13.2.4 Database functionality shall be unavailable a maximum of thirty (30) minutes per year;

13.2.5 Sprint shall provide Database provisioning consistent with the provisioning requirements of this Agreement (*e.g.*, data required, edits, acknowledgments, data format, transmission medium and notification of order completion);

13.2.6 The operational interface provided by Sprint shall complete Database transactions (*i.e.*, add, modify, delete) for MCIIm subscriber records stored in Sprint databases within twenty-four (24) hours, or sooner where Sprint provisions its own subscriber records within a shorter interval;

13.2.7 Sprint shall provide Database maintenance consistent with the maintenance requirements as specified in this Agreement (*e.g.*, notification of Sprint Network Affecting Events, testing, dispatch schedule and measurement and exception reports);

13.2.8 Sprint shall provide billing and recording information to track database usage consistent with connectivity billing and recording requirements as specified in this Agreement (*e.g.*, recorded message format and content, timeliness of feed, data format and transmission medium);

13.2.9 Sprint shall provide SCPs/Databases in accordance with the physical security requirements specified in this Agreement; and

13.2.10 Sprint shall provide SCPs/Databases in accordance with the logical security requirements specified in this Agreement.

### 13.3 Line Information Database ("LIDB")

This Section 13.3 defines and sets forth additional requirements for the Line Information Database. This Section 13.3 supplements the requirements of Section 13.1 and 13.6.

#### 13.3.1 Definition

The Line Information Database ("LIDB") is a transaction-oriented database accessible through Common Channel Signaling ("CCS") networks. It contains records associated with subscribers' line numbers and special billing numbers (in accordance with the requirements in the technical reference in Section 13.6.5). LIDB accepts queries from other Network Elements, or MCIIm's network,

and provides appropriate responses. The query originator need not be the owner of LIDB data. LIDB queries include functions such as screening billed numbers that provides the ability to accept collect or third number billing calls and validation of telephone line number based non-proprietary calling cards. The interface for the LIDB functionality is the interface between the Sprint CCS network and other CCS networks. LIDB also interfaces to administrative systems. The administrative system interface provides work centers with an interface to LIDB for functions such as provisioning, auditing of data, access to LIDB measurements and reports.

### **13.3.2 Technical Requirements**

**13.3.2.1** Prior to the availability of a long-term solution for Number Portability, Sprint shall enable MCIIm to store in Sprint's LIDB any subscriber line number or special billing number record, (in accordance with the technical reference in Section 13.6.5) whether ported or not, for which the NPA-NXX or NXX-0/1XX group is supported by that LIDB.

**13.3.2.2** Prior to the availability of a long-term solution for Number Portability, Sprint shall enable MCIIm to store in Sprint's LIDB any subscriber line number or special billing number (in accordance with the technical reference in Section 13.6.5) record, whether ported or not, and NPA-NXX and NXX-0/1XX group records, belonging to an NPA-NXX or NXX-0/1 XX owned by MCIIm.

**13.3.2.3** Subsequent to the availability of a long-term solution for Number Portability, Sprint shall enable MCIIm to store in Sprint's LIDB any subscriber line number or special billing number (in accordance with the technical reference in Section 13.6.5) record, whether ported or not, regardless of the number's NPA-NXX or NXX-0/1XX.

**13.3.2.4** Sprint shall perform the following LIDB functions (*i.e.*, processing of the following query types as defined in the technical reference in Section 13.6.5) for MCIIm's subscriber records in LIDB:

**13.3.2.4.1** Billed number screening (provides information such as whether the billed number may accept collect or third number billing calls); and

**13.3.2.4.2** Calling card validation.

13.3.2.5 Sprint shall process MCI's subscriber records in LIDB at least at Parity with Sprint subscriber records, with respect to other LIDB functions (as defined in the technical reference in Section 13.4). Sprint shall indicate to MCI what additional functions (if any) are performed by LIDB in their network.

13.3.2.6 As soon as possible but not later than thirty (30) days after a request by MCI, Sprint shall provide MCI with a list of the subscriber data items which MCI would have to provide in order to support each required LIDB function. The list shall indicate which data items are essential to LIDB function, and which are required only to support certain services. For each data item, the list shall show the data formats, the acceptable values of the data item and the meaning of those values.

13.3.2.7 Sprint shall provide LIDB systems for which functionality would not result in calls being blocked in excess of thirty (30) minutes per year.

13.3.2.8 Total unavailability for LIDB systems shall not exceed twelve (12) hours per year.

13.3.2.9 Sprint shall provide LIDB systems for which the LIDB function shall be in overload (degraded Performance in accordance with the technical reference in Section 13.6.5) no more than twelve (12) hours per year. Such deficiency period is in addition to the periods specified in Sections 13.3.2.7 and 13.3.2.8 above.

13.3.2.10 Upon installation of software supporting the following function, Sprint shall provide MCI with the capability to provision (e.g., to add, update, and delete) NPA-NXX and NXX-0/XX group records, and line number and special billing number records, associated with MCI subscribers, directly into Sprint's LIDB provisioning process.

13.3.2.11 When directed by MCI, in the event that end user subscribers change their local service provider, Sprint shall maintain subscriber data (for line numbers, card numbers, and for any other types of data maintained in LIDB) so that such subscribers shall not experience any interruption of calling card and billed number screening

services due to the lack of such maintenance of subscribers' data.

13.3.2.12 All additions, updates and deletions of MCIIm data to the LIDB shall be solely at the direction of MCIIm, except for such actions as Sprint may undertake to deter fraud.

13.3.2.13 Sprint shall provide priority updates to LIDB for MCIIm data upon MCIIm's request (e.g., to support fraud protection).

13.3.2.14 Upon the installation of software supporting the following function, Sprint shall provide MCIIm the capability to directly obtain, through an electronic interface, reports of all MCIIm data in LIDB.

13.3.2.15 Sprint shall provide LIDB systems such that no more than 0.01% of MCIIm-provided subscriber records accepted by Sprint's administrative systems will be missing from LIDB, as measured by MCIIm audits.

13.3.2.16 Sprint shall perform backup and recovery of all of MCIIm's data in LIDB at Parity with backup and recovery of all other records in the LIDB, including sending to LIDB all changes made since the date of the most recent backup copy.

13.3.2.17 Upon the installation of software supporting the following function, Sprint shall provide to MCIIm access to LIDB measurements and reports at least at Parity with the capability Sprint has for its own subscriber records and that Sprint provides to any other party. Such access shall be electronic.

13.3.2.18 Sprint shall perform, as soon as possible, correction of misroute errors. When Sprint can identify MCIIm records within Sprint's LIDB, Sprint will provide reports of data which are missing or contain errors, within the time period reasonably designated by MCIIm.

13.3.2.19 Sprint shall prevent any access to or use of MCIIm data in LIDB by Sprint personnel or by any other party that is not authorized by MCIIm in writing.

13.3.2.20 When available, Sprint shall provide MCI Performance of the LIDB data screening function, which allows a LIDB to deny specific query originators access to LIDB data owned by specific data owners, (in accordance with the technical reference in Section 13.6.5) for Subscriber Data that is part of an NPA-NXX or NXX-0/XX wholly or partially assigned to MCI at least at Parity with Sprint Subscriber Data. Sprint shall obtain from MCI the screening information associated with LIDB Data Screening of MCI data in accordance with this requirement. Sprint currently does not have LIDB data screening capabilities; however, when such capacity is available Sprint shall provide it.

13.3.2.21 Sprint shall accept queries to LIDB associated with MCI subscriber records, and shall return responses in accordance with the requirements of this Section 13.

13.3.2.22 Sprint shall provide mean processing time at the LIDB within 0.50 seconds under normal conditions as defined in the technical reference in Section 13.6.5.

13.3.2.23 Sprint shall provide processing time at the LIDB within one (1) second for ninety-nine percent (99%) of all messages under normal conditions as defined in the technical reference in Section 13.6.5.

13.3.2.24 Sprint shall provide ninety-nine and nine-tenths percent (99.9%) of all LIDB queries in a round trip response within two (2) seconds.

13.3.2.25 Sprint shall provide LIDB Performance that complies with the following standards:

13.3.2.25.1 There shall be at least a ninety-nine and nine-tenths percent (99.9%) reply rate to all query attempts.

13.3.2.25.2 Queries shall time out at LIDB no more than one-tenth percent (0.1%) of the time.

13.3.2.25.3 Data in LIDB replies shall have at no more than two percent (2%) unexpected data values, for all queries to LIDB.

13.3.2.25.4 No more than one percent (1.0%) of all LIDB queries shall return a missing subscriber record.

13.3.2.25.5 There shall be no defects in LIDB data screening of responses.

13.3.2.25.6 Group troubles shall occur for no more than one percent (1%) of LIDB queries. Group troubles include:

13.3.2.25.6.1 Missing Group — When reply is returned "vacant", but there is no active record for the six (6) digit NPA-NXX group.

13.3.2.25.6.2 Vacant Code — When a six (6) digit code is active, but is not assigned to any subscriber on that code.

13.3.2.25.6.3 Non-Participating Group and unavailable Network Resource — should be identified in the LARG (LIDB Access Routing Guide) so MCI<sup>m</sup> does not pay access for queries that will be denied in LIDB.

### 13.3.3 Interface Requirements

Sprint shall offer LIDB in accordance with the requirements of this Section 13.3.3.

13.3.3.1 The interface to LIDB shall be in accordance with the technical reference in Section 13.6.3.

13.3.3.2 The CCS interface to LIDB shall be the standard interface described in Section 13.6.3.

13.3.3.3 The LIDB Data Base interpretation of the ANSI-TCAP messages shall comply with the technical reference in Section 13.6.4. Global title translation shall be maintained in the signaling network in order to support signaling network routing to the LIDB.

### **13.4 Toll Free Number Database**

The Toll Free Number Database provides functionality necessary for toll free (e.g., 800 and 888) number services by providing routing information and additional vertical features during call set-up in response to queries from SSPs. This Section 13.4 supplements the requirements of Sections 13.2 and 13.6. Sprint shall provide the Toll Free Number Database in accordance with the following:

#### **13.4.1 Technical Requirements**

13.4.1.1 Sprint shall make the Sprint Toll Free Number Database available for MCIIm to query, from MCIIm's designated Switch including Sprint unbundled Local Switching with a toll free number and originating information.

13.4.1.2 The Toll Free Number Database shall return carrier identification and, where applicable, the queried toll free number, translated numbers and instructions as it would in response to a query from a Sprint Switch.

13.4.1.3 The SCP shall also provide, at MCIIm's option, such additional feature as described in SR-TSV-002275 (BOC Notes on the Sprint Networks, SR-TSV-002275, Issue 2 (Bellcore, April 1994)) as are available to Sprint. These may include, but are not limited to:

13.4.1.3.1 Network Management;

13.4.1.3.2 Subscriber Sample Collection; and

13.4.1.3.3 Service Maintenance.

#### **13.4.2 Interface Requirements**

The signaling interface between the MCIIm or other local Switch and the Toll Free Number Database shall use the TCAP protocol as specified in the technical reference in Section 13.6.1, together with the signaling network interface as specified in the technical reference in Sections 13.6.2 and 13.6.6.

13.5 SCPs/Databases shall be equal to or better than all of the requirements for SCPs/Databases set forth in the following technical references:

13.5.1 GR-246-CORE, Bell Communications Research Specification of Signaling System Number 7, Issue 1 (Bellcore, December 1995);

13.5.2 GR-1432-CORE, CCS Network Interface Specification ("CCSNIS") Supporting Signaling Connection Control Part ("SCCP") and Transaction Capabilities Application Part ("TCAP") (Bellcore, March 1994);

13.5.3 GR-954-CORE, CCS Network Interface Specification ("CCSNIS") Supporting Line Information Database ("LIDB") Service 6, Issue 1, Rev. 1 (Bellcore, October 1995);

13.5.4 GR-1149-CORE, OSSGR Section 10: System Interfaces, Issue 1 (Bellcore, October 1995) (Replaces TR-NWT-001149);

13.5.5 GR-1158-CORE, OSSGR Section 22.3: Line Information Database 6, Issue (Bellcore, October 1995);

13.5.6 GR-1428-CORE, CCS Network Interface Specification ("CCSNIS") Supporting toll free service (Bellcore, May 1995); and

13.5.7 Bellcore Special Report SR-TSV-002275, IBOC Notes on the LEC Networks - Signaling.

**13.6 Advanced Intelligent Network ("AIN") Access, Service Creation Environment and Service Management System ("SCE/SMS")  
Advanced Intelligent Network Access**

When Technically Feasible, Advanced Intelligent Network ("AIN") Access, Service Creation Environment and Service Management System ("SCR/SMS") Advanced Intelligent Network Access will be offered. This Agreement will be amended to include requirements when available.

**Section 14. Tandem Switching**

**14.1 Definition**

Tandem Switching is the function that establishes a communications path between two (2) switching offices (connecting trunks to trunks) through a third switching office (the tandem Switch) including, but not limited to, CLEC, Sprint, independent telephone companies, IXCs and wireless carriers.



## 14.2 Technical Requirements

14.2.1 Tandem Switching shall have the same capabilities or equivalent capabilities as those described in Bell Communications Research TR-TSY-000540 Issue 2R2, Tandem Supplement, 6//90. The requirements for Tandem Switching include, but are not limited to, the following:

14.2.1.1 Tandem Switching shall provide signaling to establish a tandem connection;

14.2.1.2 Tandem Switching shall provide screening and routing as designated by MCI;m;

14.2.1.3 Tandem Switching shall provide recording of all billable events designated by MCI;m;

14.2.1.4 Where available, Tandem Switching shall provide Advanced Intelligent Network ("AIN") triggers supporting AIN features;

14.2.1.5 Tandem Switching shall provide connectivity to Operator Systems as designated by MCI;m;

14.2.1.6 Tandem Switching shall provide access to toll free number portability database as designated by MCI;m;

14.2.1.7 Tandem Switching shall provide all trunk interconnections discussed under the "Network Interconnection" section (e.g., SS7, MF, DTMF, Dial Pulse, PRI-ISDN, DID, and CAMA-ANI (if appropriate for 911));

14.2.1.8 Tandem Switching shall provide connectivity to PSAPs where 911 solutions are deployed and the tandem is used for 911; and

14.2.1.9 Tandem Switching shall provide connectivity to transit traffic to and from other carriers.

14.2.2 Tandem Switching shall accept connections (including the necessary signaling and trunking interconnections) between end offices, other tandems, IECs, ICOs, CAPs and CLEC Switches.

14.2.3 Tandem Switching shall provide local tandeming functionality between two (2) end offices including two (2) offices

belonging to different CLEC's (e.g., between an MCI end office and the end office of another CLEC).

14.2.4 Tandem Switching shall preserve CLASS/LASS features and Caller ID as traffic is processed. Additional signaling information and requirements are provided in Section 12.

14.2.5 To the extent Technically Feasible, Tandem Switching shall record billable events and send them to the area billing centers designated by MCI. Billing requirements are specified in Attachment VIII of this Agreement.

14.2.6 Sprint shall perform routine testing and fault isolation on the underlying Switch that is providing Tandem Switching and all its interconnections. When requested by MCI, the results and reports of the testing shall be made available to MCI in a timeframe agreed upon by the Parties.

14.2.7 When requested by MCI, Sprint shall provide Performance data regarding traffic characteristics or other measurable elements to MCI for review.

14.2.8 Tandem Switching shall control congestion using capabilities such as Automatic Congestion Control and Network Routing Overflow. Congestion control provided or imposed on MCI traffic shall be at Parity with controls being provided or imposed on Sprint traffic (e.g., Sprint shall not block MCI traffic and leave its traffic unaffected or less affected).

14.2.9 Tandem Switching shall route calls to Sprint or MCI endpoints or platforms (e.g., Operator Services and PSAPs) on a per call basis as designated by MCI. Detailed primary and overflow routing plans for all interfaces available within the Sprint switching network shall be mutually agreed to by MCI and Sprint.

14.2.10 Tandem Switching shall process originating toll free traffic received from an MCI local Switch.

14.2.11 In support of AIN triggers and features, Tandem Switching shall provide SSP capabilities when these capabilities are not available from the Local Switching Network Element.

14.2.12 The Local Switching and Tandem Switching functions may be combined in an office. If this is done, both Local Switching and

Tandem switching shall provide all of the functionality required of each of those Network Elements in this Agreement.

### **14.3 Interface Requirements**

14.3.1 Tandem Switching shall provide interconnection to the E911 PSAP where the underlying Tandem is acting as the E911 Tandem.

14.3.2 Tandem Switching shall interconnect, with direct trunks, to all carriers with which Sprint interconnects.

14.3.3 Sprint shall provide all signaling necessary to provide Tandem Switching with no loss of feature functionality.

14.3.4 Tandem Switching shall interconnect with MCI's Switch, using two-way trunks, for traffic that is transiting via the Sprint network to InterLATA or IntraLATA carriers. At MCI's request, Tandem Switching shall record and keep records of traffic for billing.

14.3.5 At MCI's request, Tandem Switching shall provide overflow routing of traffic from a given trunk group or groups onto another trunk group or groups according to the methodology that MCI designates.

14.4 Tandem Switching shall meet or exceed (*i.e.*, be more favorable to MCI) each of the requirements for Tandem Switching set forth in the following technical references:

14.4.1 Bell Communications Research TR-TSY-000540 Issue 2R2, Tandem Supplement, 6/1/90;

14.4.2 GR-905-CORE covering CCSNIS; and

14.4.3 GR-1429-CORE for call management features, and GR-2863-CORE and GR-2902-CORE covering CCS AIN interconnection.

### **Section 15. Additional Requirements**

This Section 15 of Attachment III sets forth the additional requirements for unbundled Network Elements which Sprint agrees to offer to MCI under this Agreement.

## 15.1 Cooperative Testing

### 15.1.1 Definition

Cooperative Testing means that Sprint shall cooperate with MCIIm upon request or as needed to: (1) ensure that the Network Elements and ancillary functions and additional requirements being provided to MCIIm by Sprint are in compliance with the requirements of this Agreement; (2) test the overall functionality of various Network Elements and ancillary functions provided by Sprint to MCIIm in combination with each other or in combination with other equipment and facilities provided by MCIIm or third Parties; and (3) ensure that all operational interfaces and processes are in place and functioning properly and efficiently for the provisioning and maintenance of Network Elements and ancillary functions and so that all appropriate billing data can be provided to MCIIm.

### 15.1.2 Requirements

Within forty-five (45) days of the Effective Date of this Agreement, MCIIm and Sprint will agree upon a process to resolve technical issues relating to interconnection of MCIIm's network to Sprint's network and Network Elements and Ancillary Functions. The agreed upon process shall include procedures for escalating disputes and unresolved issues up through higher levels of each Party's management. If MCIIm and Sprint do not reach agreement on such a process within forty-five (45) days, any issues that have not been resolved by the Parties with respect to such process shall be submitted to the procedures set forth in Part A Section 23 of this Agreement, unless both Parties agree to extend the time to reach agreement on such issues.

15.1.2.1 Sprint shall provide MCIIm access for testing at any interface between a Sprint Network Element or Combinations and MCIIm equipment or facilities. Such test access shall be sufficient to ensure that the applicable requirements can be tested by MCIIm. This access shall be available seven (7) days per week, twenty-four (24) hours per day. Where testing requires physical access to Sprint property, Sprint security escort guidelines will be employed.

15.1.2.1.1 Intrusive test access will generally follow the agreed to maintenance window guidelines which limits such access to the 12:00 midnight to 5:00 a.m.

timeframe. Exceptions to this guideline include equipment and services which, due to subscribers' normal off-peak usage, fall outside this timeframe. In such cases, test and maintenance will be performed during a timeframe jointly agreed to by Sprint, MCI and the subscriber(s).

**15.1.2.2 MCI may test any interfaces, Network Elements or ancillary functions and additional requirements provided by Sprint pursuant to this Agreement.**

**15.1.2.3 Sprint shall provide engineering data as requested by MCI for the Loop components as set forth in Sections 2, 3 and 4 of this Attachment which MCI may desire to test. Such data shall include equipment engineering and cable specifications, signaling and transmission path data.**

**15.1.2.4 Upon MCI's request, Sprint shall provide to MCI any of its office records, Central Office layout and design records and drawings, system engineering and other applicable documentation (other than proprietary information of third parties) pertaining to a Network Element or ancillary function or the underlying equipment that is then providing a Network Element or ancillary function to MCI.**

**15.1.2.5 Sprint shall provide to MCI test results, from Sprint testing activities on a Network Element or ancillary function or additional requirement or the underlying equipment providing a Network Element or ancillary function or additional requirements. The types and frequency of such testing shall be agreed to by MCI and Sprint and shall not be unreasonably withheld. MCI may review such testing results and may notify Sprint of any deficiencies that are detected.**

**15.1.2.6 Sprint shall temporarily provision MCI designated Local Switching features for testing. Within sixty (60) days of the Effective Date of this Agreement, MCI and Sprint shall mutually agree on the procedures to be established between Sprint and MCI to expedite such provisioning processes for feature testing.**

**15.1.2.7 Upon MCI's request, Sprint shall provide technical staff to meet with MCI representatives to provide required support for Cooperative Testing.**

15.1.2.8 Dedicated Transport and Loop Feeder may experience alarm conditions due to in-progress tests. Sprint shall not remove such facilities from service without obtaining MCI's prior approval. Prior to pre-planned testing of Dedicated Transport and Loop Feeder, MCI will provide Sprint with expected testing timeframes, and appropriate contact numbers pursuant to Section 15.1.2.10 below.

15.1.2.9 Sprint shall notify MCI prior to conducting tests or maintenance procedures on Network Elements or Ancillary Functions or on the underlying equipment that is then providing a Network Element or Ancillary Function, that may cause a service interruption or degradation of service. MCI may request that such testing be conducted at a specified time, or that such test not be conducted during a specified time frame. Sprint shall attempt to accommodate MCI's request.

15.1.2.10 Sprint shall provide a single point of contact to MCI that is available seven (7) days per week, twenty-four (24) hours per day for trouble status, sectionalization, resolution, escalation, and closure. Such staff shall be adequately skilled to allow expeditious problem resolution.

15.1.2.11 Sprint shall provide to MCI electronic access to one hundred five (105) responders, one hundred (100) type test lines, or one hundred two (102) type test lines associated with any circuits under test.

15.1.2.12 Sprint shall participate in Cooperative Testing with MCI upon MCI's request to test any operational interface or process used to provide Network Elements, Ancillary Functions or Services to MCI.

15.1.2.13 MCI and Sprint shall endeavor to complete Cooperative Testing as stated in Attachment VIII.

15.1.2.14 Sprint shall participate in Cooperative Testing requested by MCI whenever it is deemed necessary by MCI to ensure service Performance, reliability and subscriber serviceability.

15.1.2.15 MCI may accept or reject the Network Element ordered by MCI if, upon completion of cooperative

acceptance testing, the tested Network Element does not meet the requirements stated herein.

## **15.2 Performance**

### **15.2.1 Scope**

This Section addresses Performance requirements for Network Elements and Ancillary Functions to provide local service. It includes requirements for the reliability and availability of Network Elements and Ancillary Functions, and quality parameters such as transmission quality (analog and digital) and speed (or delay). In addition, an overview of service Performance requirements is given.

**15.2.1.1** The general Performance requirements in this Section apply to all aspects of Network Elements and Ancillary Functions. Additional requirements are given in this Performance Section and in the individual Network Elements Sections.

**15.2.1.2** Sprint shall work cooperatively with MCI to determine appropriate Performance allocations across Network Elements.

**15.2.2** Sprint shall provide Performance in accordance with the requirements set forth in the technical references cited in this Attachment III and in no event shall Performance be less than Sprint provides for itself:

#### **15.2.2.1 Bell Communications Research, Inc. Documents**

**15.2.2.1.1** FR-64, LATA Switching Systems Generic Requirements ("LSSGR"). This document contains 117 Technical References and Generic Requirements. Sections provide the requirements for Local Switching systems (also referred to as end offices) that serve subscribers' lines. Some modules of the LSSGR are also referenced separately in this document.

**15.2.2.1.2** TR-NWT-000499, Issue 5, Rev 1, April 1992, Transport Systems Generic Requirements ("TSGR"): Common Requirements.

15.2.2.1.3 TR-NWT-000418, Issue 2, December 1992, Generic Reliability Assurance Requirements For Fiber Optic Transport Systems.

15.2.2.1.4 TR-NWT-000057, Issue 2, January 1993, Functional Criteria for Digital Loop Carriers Systems.

15.2.2.1.5 TR-NWT-000507, Issue 5, December 1993, LSSGR - Transmission, Section 7.

15.2.2.1.6 GR-303-CORE, Issue 1, September 1995, Integrated Digital Loop Carrier System Generic Requirements, Objectives, and Interface.

15.2.2.1.7 GR-334-CORE, Issue 1, June 1994, Switched Access Service, Transmission Parameter Limits and Interface Combinations.

15.2.2.1.8 TR-NWT-000335, Issue 3, May 1993, Voice Grade Special Access Services - Transmission Parameter Limits and Interface Combinations.

15.2.2.1.9 TR-TSY-000529, Issue 2, July 1987, Public Safety - LSSGR.

15.2.2.1.10 GR-1158-CORE, Issue 2, October 1995, OSSGR Section 22.3, Line Information Database.

15.2.2.1.11 TR-TSY-000511, Issue 2, July 1987, Service Standards, a Module (Section 11) of LATA Switching Systems Generic Requirements (LSSGR, FR-NWT-000064).

15.2.2.1.12 TR-NWT-000393, January 1991, Generic Requirements for ISDN Basic Access Digital Subscriber Lines.

15.2.2.1.13 TR-NWT-000909, December 1991, Generic Requirements and Objectives for Fiber In The Loop Systems.

15.2.2.1.14 TR-NWT-000505, Issue 3, May 1991, LSSGR Section 5, Call Processing.



15.2.2.1.15 FR-NWT-000271, 1993, Operator Services Systems Generic Requirements ("OSSGR").

15.2.2.1.16 TR-NWT-001156, Issue 2, July 1993, OSSGR Operator Services Systems Generic Requirements, Section 21, Operator Subsystem.

15.2.2.1.17 SR-TSY-001 171, Issue 1, January 1989, Methods and Procedures for System Reliability Analysis.

15.2.2.1.18 Bellcore, Telecommunications Transmission Engineering, 3rd Ed., 1990.

15.2.2.1.19 TA-NPL-000912, Issue 1, February 1989, Chapter 6: *Transmission Characteristics at Network Interface*.

15.2.2.1.20 Notes on the BOC Intra-LATA networks, 1993.

15.2.2.1.21 TR-NPL-340, Wideband Data Special Access Services Transmission Parameter Limits and Interface Combinations

#### 15.2.2.2 ANSI Standards

15.2.2.2.1 ANSI T1.512-1994, Network Performance - Point-to-Point Voice-Grade Special Access Network Voiceband Data Transmission Objectives.

15.2.2.2.2 ANSI T1.506-1990, Network Performance - Transmission Specifications for Switched Exchange Access Network.

15.2.2.2.3 ANSI T1.508-1992, Telecommunications - Network Performance - Loss Plan for Evolving Digital Networks. Also supplement T1.508a-1993.

15.2.2.2.4 ANSI T1.101-1994, Digital Synchronization Network Plan.

15.2.2.2.5 ANSI T1.401-1992, "Interface Between Carriers and Customer Installations - Analog

Voicegrade Switched Access Lines Using Loop Start and Ground Start Signaling.”

### **15.2.2.3 TIA/EIA Standards**

**15.2.2.3.1 Electronic Industries Association/Telecommunications Industries Association Standards and Engineering Publications not enumerated below may be referred to for additional applicable parameters.**

**15.2.2.3.2 TIA/EIA TSB-37A, Telephone Network Transmission Model for Evaluating Modem Performance.**

**15.2.2.3.3 TIA/EIA TSB-38, Test Procedure for Evaluation of two (2)-wire 4 kHz Voiceband Duplex Modems.**

### **15.2.2.4 IEEE Standards**

**15.2.2.4.1 IEEE Standard 743-1984, IEEE Standard Methods and Equipment for Measuring Transmission Characteristics of Analog Voice Frequency Circuits.**

**15.2.2.4.2 ANSI/IEEE Standard 820-1984, Telephone Loop Performance Characteristics.**

### **15.2.2.5 REA Standards**

**Rural Electrification Administration Telecommunications Engineering and Construction Manual Section 424, Issue No. 4, May 1988, Draft.**

## **15.2.3 Services and Capabilities**

**15.2.3.1 All Network Elements shall provide Performance sufficient, in combination with other Network Elements, to provide the following applications in accordance with the requirements of this document:**

**15.2.3.1.1 All types of voice services;**

**15.2.3.1.2 All types of voice-band data modem connections up to and including 28.8 Kbps V-34;**

15.2.3.1.3 All types of FAX transmissions up to and including 14.4 Kbps group 3;

15.2.3.1.4 All CLASS/LASS features; and

15.2.3.1.5 All Operator Systems.

15.2.3.2 The following capabilities shall be provided as applicable:

15.2.3.2.1 ISDN BRI;

15.2.3.2.2 ISDN PRI;

15.2.3.2.3 Switched digital data;

15.2.3.2.4 Non-switched digital data;

15.2.3.2.5 Any types of video applications that a subscriber may order;

15.2.3.2.6 Any Coin Services the subscriber may order;

15.2.3.2.7 Frame Relay and ATM; and

15.2.3.2.8 Private Line Services.

#### **15.2.4 Specific Performance Requirements for Network Elements and Ancillary Functions**

15.2.4.1 Sprint shall provide performance of Network Elements and Ancillary Functions in accordance with the requirements of the industry standards set forth in Section 15.2.2 above as such standards pertain to the provision of local services, and in no event shall Sprint's performance be less than Sprint provides for itself, its Affiliates or other local telecommunications carriers. The loop specifications below were extracted from industry standards and knowledge of realistic loop performance. In some cases these specifications may not apply to a specific loop implementation. Some implementations may be covered in more detail by TR-NPL-57, GR-334, CORE, or REA 424. For example, in GR-334-CORE, Feature Group A, WAL, and JIS describe various practical loop implementations. Where

more than one specification applies to a loop, the more realistic one applies.

15.2.4.1.1 Any request by MCI for access to a work Element or for a level of Performance that is not otherwise provided by the terms of this Agreement at the time of such request shall be made pursuant to a Bona Fide Request, as described in Section 24 of Part A, and shall be subject to the payment by MCI of all applicable costs in accordance with the Act.

#### **15.2.4.2 Performance Allocation**

15.2.4.2.1 Transmission path impairments may be classified as either analog or digital, and will depend on the nature of the signal transmitted across the Network Element. Analog impairments are introduced on any analog portion of the Loop, typically between the NID [portion of Loop Distribution] and the analog to digital (A/D) conversion, and are usually correlated with the length of the physical plant. Digital impairments are introduced by A/D conversion and by interfaces between digital Network Elements. In addition, noise can be introduced by either analog transmission or the A/D conversion.

#### **15.2.4.3 Loop Combination Architecture Constraints**

15.2.4.3.1 The following constraints will limit not only the variety of loop combination architectures that may be considered, but also the architectures Sprint may consider to deliver any Ancillary Function or Network Element. These constraints apply to the entire path between the NID and the loop terminals at the boundary of the Sprint Switch. Any exceptions to these restrictions shall be specifically requested or approved by MCI in writing.

15.2.4.3.1.1 No more than 1 A-D conversion pair (one free-standing loop carrier allowed; two or more on one loop not allowed);

15.2.4.3.1.2 No more than 1, 2-to-4-wire hybrid pair (as above);

15.2.4.3.1.3 No voice compression, except as may be required for proper operation of an overall system, e.g., a compander carrier system;

15.2.4.3.1.4 No echo canceled or suppressers;

15.2.4.3.1.5 One digital loss pad per PBX trunk at the Sprint switch;

15.2.4.3.1.6 No digital gain; and

15.2.4.3.1.7 No additional equipment that might significantly increase intermodulation distortion.

#### **15.2.4.4 Transmission Impairments**

##### **15.2.4.4.1 Analog Impairments**

15.2.4.4.1.1 Analog Impairments are those introduced on portions of the end-to-end circuit on which communications signals are transmitted in analog format. These portions of the transmission path would typically be between NID and an A/D conversion, most commonly on the metallic loop. The performance on the analog portion of a circuit is typically inversely proportional to the length of that circuit. These analog impairment requirements shall apply to any single loop.

##### **15.2.4.4.1.2 Loss**

15.2.4.4.1.2.1 Electrical loss is measured using a 1004 Hz 0.0 DB one Milliwatt standard termination test tone.

15.2.4.4.1.2.2 Off-hook electrical Loss between the NID and the switch shall be no more than 8.0 dB for any line, and the mean value for all lines shall be <5.0 dB.

### 15.2.4.4.1.3 Idle Channel Circuit Noise

15.2.4.4.1.3.1 Idle channel circuit noise (C-message) is added by analog facilities. Although such noise also is added by the A/D conversion of signals, by digital processing equipment (e.g., echo cancelers, digital loss pads), robbed bit signaling, and errors on digital facilities, such causes are not included in this requirement because this requirement pertains only to metallic analog loops.

15.2.4.4.1.3.2 Idle channel circuit noise shall be less than or equal to 20 dBnC.

### 15.2.4.4.1.4 Talker Echo

15.2.4.4.1.4.1 The primary source of echo is improper impedance-matching at the 2-to-4 wire hybrid in the Sprint network. The impact on subscriber perception is a function of both echo return loss and delay.

15.2.4.4.1.4.2 Echo Return Loss ("ERL") shall be as specified in Bellcore technical references.

### 15.2.4.4.1.5 Listener Echo

Listener Echo is a double reflection of a transmitted signal at two (2) different impedance mismatches in the end-to-end connection. While in extreme cases it can degrade voice transmission Performance, Listener Echo is primarily an issue for voiceband data. The requirements on Talker Echo shall apply to Listener Echo.

**15.2.4.4.1.6 Propagation Delay and Processing Delay**

15.2.4.4.1.6.1 Propagation Delay is the delay involved in transmitting information from one location to another. It is caused by processing delays of equipment in the network and delays associated with traveling across transmission facilities.

15.2.4.4.1.6.2 Sprint shall cooperate with MCI to limit total service Propagation and Processing Delay to levels at Parity with that within the Sprint local network.

**15.2.4.4.1.7 Signal-to-Noise Ratio**

15.2.4.4.1.7.1 The Signal-to-Noise Ratio ("S/N") is a critical parameter in determining voiceband data Performance. It is typically measured with a 1004 Hz tone.

15.2.4.4.1.7.2 Sprint must provide on the Loop Combination a signal-to-noise ratio of at least 22 dB between the NID and the end office in accordance with TR-NWT-57 or GR-334-CORE as applicable.

**15.2.4.4.1.8 C-Notched Noise**

The requirements for Signal-to-Noise Ratio shall apply to C-Notched Noise.

**15.2.4.4.1.9 Attenuation Distortion**

15.2.4.4.1.9.1 Attenuation Distortion, also known as frequency distortion or gain slope, measures the variations in loss at different frequencies across the voice frequency spectrum (404 Hz-2804 Hz). It is measured by subtracting the

loss at 1004 Hz from the loss at the frequency of interest.

15.2.4.4.1.9.2 Attenuation Distortion shall remain within the range -1.5 dB/+5 dB for the frequencies 404 Hz and 2804 Hz with reference to 1004 Hz IAW Bellcore GR-334-CORE.

#### **15.2.4.4.1.10 Envelope Delay Distortion**

15.2.4.4.1.10.1 Envelope Delay Distortion ("EDD"), also known as relative delay, measures the difference in transit time of signals at different frequencies. EDD is measured relative to the transit time of a specified tone, and is given in microseconds. EDD is used as an approximation of the group delay of the channel.

15.2.4.4.1.10.2 EDD shall be as specified in the applicable technical references.

#### **15.2.4.4.1.11 Phase Jitter**

15.2.4.4.1.11.1 Phase jitter measures the unwanted angular modulation of a signal. It is caused by noise or the actual modulation of the signal by another unwanted signal. It displaces the zero crossings of a signal. It is measured in terms of peak-to-peak deviations of a 1004 Hz tone from its nominal zero crossings, and in a specified frequency band. Phase jitter impacts voiceband data performance and can make modems more susceptible to other impairments, including noise.

15.2.4.4.1.11.2 From the Sprint C.O. to the NID or interexchange carrier point of



termination, phase jitter shall be  $< 7.0^\circ$  peak-to-peak in the 4-300 Hz band IAW GR-334-CORE.

#### **15.2.4.4.1.12 Amplitude Jitter**

15.2.4.4.1.12.1 Amplitude Jitter is any deviation of the peak value of a 1004 Hz signal from its nominal value. Excessive amounts can impair voiceband data Performance. It is primarily caused by noise but can also be caused by Phase Jitter, gain hits, or single frequency interference.

15.2.4.4.1.12.2 Amplitude Jitter shall be consistent with Bellcore ST-TEC-000053, Network Engineering or the most applicable technical reference.

#### **15.2.4.4.1.13 Intermodulation Distortion**

15.2.4.4.1.13.1 Intermodulation Distortion ("IMD") measures non-linear distortions of a signal. It compares the power of unwanted tones to the power of the transmitted tones. It is measured for both the second and third mixing orders of the transmitted tones. IMD is caused by compression or clipping and can impair voiceband data Performance.

15.2.4.4.1.13.2 Both second and third order IMD between the NID and end office shall be  $> 31$  and  $34$  dB respectively or IAW GR-334-CORE or the most applicable technical reference.

#### **15.2.4.4.1.14 Impulse Noise**

15.2.4.4.1.14.1 Impulse noise is a sudden and large increase in noise on a channel for a short duration of time.

Impulse noise is measured as a count of the number of times a noise threshold is exceeded during a given time period (typically five (5) or fifteen (15) minutes). It is caused by protection switching, maintenance activities, electro-mechanical switching systems, digital transmission errors, and line coding mismatches. Impulse noise sounds like clicking noises or static on voice connections. Impulse noise impairs voiceband data Performance and is highly dependent on the local thunderstorm rate.

15.2.4.4.1.14.2 The NID to interexchange carrier point of termination portions of connections shall introduce no more than 15 impulse noise events exceeding a threshold of 67dBmC in any 15 minute period IAW GR-334-CORE.

#### 15.2.4.4.1.15 Phase Hits

15.2.4.4.1.15.1 Phase hits are a sudden change in the phase of a signal lasting a predetermined time. Phase hits are measured using a threshold which indicates how much the phase of the signal has changed with respect to its nominal phase. Phase hits are caused by protection switching and slips or other synchronization errors. Phase hits can impair voiceband data Performance.

15.2.4.4.1.15.2 Between the NID and Interexchange Carrier point of termination, ninety-nine and three quarters percent (99.75%) of all fifteen (15) minute connections shall have no phase hits exceeding twenty degrees (20°). In addition, there shall be no

more than one (1) phase hit exceeding twenty degrees (20°) in any thirty (30)-minute period.

#### **15.2.4.4.1.16 Gain Hits**

15.2.4.4.1.16.1 Gain hits are sudden changes in the level of a signal that last a predetermined time or longer. Gain hits are measured against a predetermined threshold relative to the signal's nominal level. Gain hits are usually caused by protection switches and can impair voiceband data Performance.

15.2.4.4.1.16.2 On any single loop, ninety-nine and one-half percent (99.5%) of all fifteen (15)-minute connections shall have no Gain hits exceeding three (3) dB. In addition, there shall be no more than one (1) Gain hit exceeding three (3) dB in any thirty (30)-minute period.

#### **15.2.4.4.1.17 Dropouts**

15.2.4.4.1.17.1 Dropouts are drops in the level of a signal of twelve (12) dB or more a specified level for at least ten (10) msec. They are caused by protection switching events, radio fading, and conditions causing digital carrier systems to lose frame. Dropouts are critical for voiceband data Performance but, if severe enough, will also affect voice quality.

15.2.4.4.1.17.2 Between the NID and the Interexchange Carrier point of termination, ninety-nine and nine-tenths percent (99.9%) of all fifteen (15)-minute connections shall have no dropouts and in addition, no connection shall suffer

more than one (1) dropout in any sixty (60)-minute period.

#### **15.2.4.4.1.18 Frequency Shift**

15.2.4.4.1.18.1 Frequency shift measures any frequency changes that occur when a signal is transmitted across a channel. It is typically measured using a 1004 Hz tone. Frequency shift has very little impact on voice or voiceband data Performance; however, round-trip frequency shifts can affect the ability of echo cancelers to remain converged.

15.2.4.4.1.18.2 No more than 0.2 Hz frequency shift shall be on any connection. In addition, ninety-nine and one-half percent (99.5%) of all calls shall have frequency shift < 0.1 Hz.

#### **15.2.4.4.1.19 Cross-talk**

15.2.4.4.1.19.1 Cross-talk is the presence of signals from other telephone connections on a circuit. Cross-talk can be either intelligible, when speech from other connections can be heard and understood, or unintelligible. Cross-talk is caused by inter-channel interference on the transmission system. Cross-talk is difficult to measure: it requires correlating signals on different circuits or using human listeners to identify its presence. Trouble reports may be used to estimate the probability of Cross-talk.

15.2.4.4.1.19.2 Ninety-nine percent (99%) of Loop Combinations shall have probability  $\leq 0.1\%$  of experiencing Cross-talk exceeding -65 dBm0.

#### 15.2.4.4.1.20 Clipping

15.2.4.4.1.20.1 Clipping occurs when part of a transmitted signal is dropped and does not reach the receiving portion on a connection. It can be caused by Digital Speech Interpolation ("DSI") equipment used in Digital Circuit Multiplication Systems ("DCMS") which increase the amount of traffic that transmission facilities carry, and by echo cancelers or echo suppressers.

15.2.4.4.1.20.2 No Clipping incidents shall occur on any call.

#### 15.2.4.4.2 Digital Impairments

Digital impairments occur in the signal wherever it is transmitted in digital format. These errors are usually introduced upon conversion of the signal from analog to digital, as well as at interfaces between digital components. While many digital impairments have little impact on subjective voice quality, they can impact voiceband data Performance. These digital impairments requirements shall apply to any one digital facility (e.g., subscriber carrier, digital remote switch, distribution carrier, end office, etc.).

##### 15.2.4.4.2.1 Signal Correlated Distortion

15.2.4.4.2.1.1 Signal Correlated Distortion ("SCD") is unwanted noise or distortion introduced into a signal through the conversion of a signal from analog to digital format or through digital processing that changes the transmitted signal. SCD affects Performance when a sign is being transmitted. The primary sources of SCD are signal encoders, echo cancelers, digital loss pads, and robbed bit signaling. SCD affects both voice and voiceband data Performance.

15.2.4.4.2.1.2 The NID-to-end office connection shall allow:

15.2.4.4.2.1.2.1 A maximum of two (2) A/D conversion, using sixty-four (64) Kbps 1-law (1=255) PCM;

15.2.4.4.2.1.2.2 No voice compression;

15.2.4.4.2.1.2.3 No echo cancellation;  
and

#### **15.2.4.4.2.2 Slips**

15.2.4.4.2.2.1 Slips occur when a frame of digital data is either deleted or repeated because of differences in the clocks used to synchronize digital facilities. Slips sound like clicks or pops on voice calls and have major impact on voiceband data Performance.

15.2.4.4.2.2.2 The NID-to-Interexchange Carrier point of termination portion of connections shall have fewer than 0.45 Slips every twenty-four (24) hours on average.

#### **15.2.4.4.2.3 Digital Timing Jitter and Wander**

15.2.4.4.2.3.1 Digital Timing Jitter is the unwanted phase modulation of digital signals at rates above 10 Hz. Wander is the unwanted phase modulation of digital signals at rates below 10 Hz. Digital Timing Jitter is caused by imperfections in the timing recovery process of repeaters and the stuffing synchronization process used by multiplexer/demultiplexers. Wander is caused by slowly varying changes in digital signal phase due to clock frequency offset and drift, changes in propagation delay of terrestrial facilities due to temperature changes and

changes in the distance of satellites from the earth. These events have a major impact on voiceband data Performance.

15.2.4.4.2.3.2 The maximum Digital Timing Jitter allowed in the 10 Hz to 8 kHz frequency band at any network interface or any terminal equipment in the network is five (5) Unit Intervals ("UI"). The maximum Digital Timing Jitter allowed in the 8 kHz to 40 kHz frequency band is 0.1 UI. The objective for Wander is less than twenty-eight (28) UI at any network interface or terminal equipment.

#### **15.2.4.4.2.4 DS-1 Errored Seconds**

15.2.4.4.2.4.1 An Errored Second ("ES") on a DS-1 facility is any second during which at least one (1) bit is in error. The impact of an ES on Performance depends on the number of errors that occur during a second. Typically, voice Performance is not significantly impacted by ES but they can cause errors in voiceband data transmissions.

15.2.5.4.2.4.2 Each Sprint network shall have less than twenty (20) ESs per twenty-four (24) hour period.

#### **15.2.4.4.2.5 DS-1 Severely Errored<sup>1</sup>Seconds ("SES")**

15.2.4.4.2.5.1 A Severely Errored Second ("SES") is any second during which a DS-1 has an error rate exceeding 0.001. An SES can be caused by a loss of framing, a slip, or a protection Switch. SESs have impacts on both voice and voiceband data Performance. For voice, a SES will sound like a burst of noise or static. SESs that occur during a voiceband

data transmission cause a significant burst of errors and can cause modems to retrain.

15.2.4.4.2.5.2 The digital portion of each NID to POP connection shall have less than two (2) SESs per twenty-four (24) hour period.

#### **15.2.4.4.2.6 Short Failure Events ("SFE")**

15.2.4.4.2.6.1 A Short Failure Event ("SFE") is a Loss of Frame ("LOF") event of less than two (2) minutes' duration. An LOF event is declared when, on detection of a Loss of Signal ("LOS") or Out-of-Frame ("OOF"), a rise-slope-type integration process starts that declares a LOF after  $2.5 \pm 0.5$  sec. of continuous LOS or OOF. If the LOS or OOF is intermittent the integration process shall decay at a slope of  $1/5$  the rise slope during the period when the signal is normal. Thus, if the ratio of a LOS or OOF to a normal signal is greater than  $1/2$ , a LOF will be declared. A LOS condition shall be declared when the Network Channel Terminating Equipment has determined that  $175 \pm 75$  successive pulse positions with no pulses of either positive or negative polarity have occurred. An OOF condition shall be declared when either Network equipment or Digital Terminal Equipment detects errors in the framing pattern.

15.2.4.4.2.6.2 There shall be fewer than one (1) SFE per month.

#### **15.2.4.5 Service Availability and Reliability**

Availability refers to the time period during which the service is up and usable for its intended purpose. Reliability refers



to the probability that a task will be completed successfully, given that it is successfully begun.

#### **15.2.4.5.1 Blocked Calls**

15.2.4.5.1.1 Blocking is the fraction of call origination attempts denied service during a stated measurement period. Blocking occurs because of competition for limited resources within the network.

15.2.4.5.1.2 For IntraLATA toll service and local exchange service, the Blocking level from originating ("NID") to terminating NID shall not exceed one percent (1%) in any hour, except under conditions of service disruption. For access to or egress from a long distance network, the Blocking rate shall not exceed one-half percent (0.5%) in any hour.

#### **15.2.4.5.2 Downtime**

Downtime is the period of time that a system is in a failed state.

15.2.4.5.2.1 The average downtime for all subscriber Loop Combinations shall be less than forty-nine (49) minutes per year. The maximum downtime for ninety-nine percent (99%) of all subscriber Loop Combinations shall be less than seventy-four (74) minutes per year.

15.2.4.5.2.2 The average downtime for an end office Switch shall be less than three (3) minutes per year. The average downtime for individual trunks shall be less than twenty-eight (28) minutes per year. The average downtime for digital trunk groups shall be less than twenty (20) minutes per year. The average downtime for an individual line appearance at the Switch shall be less than twenty-eight (28) minutes per year. The average downtime for a Remote Terminal ("RT") shall be less than seventeen (17) minutes per year. The average

downtime for an individual line on a Remote Terminal ("RT") shall be less than thirteen (13) minutes per year.

15.2.4.5.2.3 The mean time to repair ("MTTR") of any equipment at an attended site shall be less than three (3) hours. The mean time to repair ("MTTR") of any equipment at an unattended site shall be less than four (4) hours. Ninety-five (95%) of all repairs to the network interface ("NID") shall be completed within twenty-four (24) hours.

15.2.4.5.2.4 There shall be no downtime due to power failures at the Switch.

15.2.4.5.2.5 The probability of a stable call being cut off shall be less than twenty (20) cutoffs per one million (1,000,000) one (1) minute calls.

15.2.4.5.2.6 The rate of ineffective machine attempts at the end office shall be less than 0.0005 (five (5) failures per ten thousand (10,000) call attempts).

15.2.4.5.2.7 *Sprint shall meet all requirements for private line services in TR-NWT-000335, ANSI T1.512-1994.*

### **15.2.4.5.3 Dial Tone Delay**

15.2.4.5.3.1 Dial-Tone Delay is the time period between a subscriber off-hook and the receipt of dial tone from an originating end office. Dial-Tone Delay has a significant effect on subscriber opinion of service quality.

15.2.4.5.3.2 The average dial-tone delay shall not exceed one and one-half percent (1.5%) of calls delayed more than three (3) seconds. At most twenty percent (20%) of calls during the high day busy hour ("HDBH") shall experience dial-tone delay greater than three (3) seconds.

#### 15.2.4.5.4 Dial Tone Removal

15.2.4.5.4.1 Dial Tone Removal is the time between recognition of the first address digit to the removal of dial tone on the line.

15.2.4.5.4.2 The maximum dial tone removal interval shall be  $\leq 500$  milliseconds.

#### 15.2.4.5.5 Post Dial Delay

15.2.4.5.5.1 Post Dial Delay ("PDD") is the amount of time a caller must wait after entering or dialing the last digit of a Destination Telephone Number ("DTN") before hearing a valid audible network response. The PDD for an end user is measured from the time the caller has pressed or dialed the last digit of a DTN until receipt of an audible network response.

15.2.4.5.5.2 The requirements given reflect an end-to-end CCS7 protocol for MCIm end users. Where a mixture of CCS7 and inband ("MF") signaling protocols are employed, an increase in the PDD can be expected.

##### 15.2.4.5.5.2.1 PDD 1 - A - Intra LSO

15.2.4.5.5.2.1.1 Intra-LSO calls do not employ external signaling protocols. The PDD for intra-LSO call flows are dependent upon the processor cycle time and traffic load conditions. This PDD is assumed to be between subscribers on the same LSO, between the Remote Switch Modules ("RSMs") on the same Host, or between an RSM and Host subscribers.

15.2.4.5.5.2.1.2 The objective for intra-LSO PDD is less than 310 milliseconds for fifty percent (50%) of all calls and

less than 460 milliseconds for ninety-five percent (95%) of all calls.

#### **15.2.4.5.5.2.2 PDD1-B-LSO to Another Local LSO**

15.2.4.5.5.2.2.1 The signaling protocols from an LSO to another LSO are assumed to employ out-of-band Common Channel Signaling System 7 ("CCS7") format. Local calls, that is, calls from an LSO to another LSO are assumed to have no more than one (1) pair of Signaling Transfer Point Switches ("STPs") and no more than one (1) data base dip.

15.2.4.5.5.2.2.2 This PDD is expected to be better than the MCIT Long Distance objective with an average PDD of  $\leq 8.70$  seconds with ninety-five percent (95%)  $\leq 1.34$  seconds.

#### **15.2.4.5.5.2.3 PDD1-C-MCIm LSO to Other LSO**

15.2.4.5.5.2.3.1 Calls from an MCIm LSO to other LSOs are dependent upon the interface agreements between MCIm and the LSO service provider and may employ CCS7, inband ("MF") or a combination of both protocols.

15.2.4.5.5.2.3.2 Calls from an MCIm LSO to another LSO via the Public Switched Network ("PSTN"), using end-to-end CCS7 signaling protocols, can expect to meet the MCIm PDD objectives of an average of two (2) seconds with ninety-five percent (95%) in  $\leq 2.5$  seconds. Calls from an MCIm LSO via the PSTN to LSOs outside the local service area are assumed to use CCS7 signaling protocols to the MCIm

Switch. The egress signaling protocols from the MCIT Switched Network to the many different local telephone company service providers however do not necessarily utilize CCS7 signaling. There are three (3) basic egress signaling configurations. They are:

15.2.4.5.5.2.3.2.1 Network Inter-Connect, CCS7 between MCI<sub>m</sub> and the local telephone company;

15.2.4.5.5.2.3.2.2 Inband Multifrequency ("MF") signaling protocols without a Sprint egress tandem in the connection; and

15.2.4.5.5.2.3.2.3 Inband MF signaling protocols with a Sprint egress tandem in the connection.

15.2.4.6.5.2.3.2.3.1 Calls from an MCI<sub>m</sub> LSO to other LSOs outside the local service area are assumed to have multiple STPs for 1+ traffic in the access and PSTN portion of the connection. The egress from the PSTN for 1+ traffic is again dependent upon the interface agreements in that service area and may consist of CCS7 or inband MF protocols.

15.2.4.6.5.2.3.2.3.2 Calls from an MCI<sub>m</sub>'s LSO to another MCI<sub>m</sub> LSO with a mixture of CCS7 or all inband signaling protocols are expected to receive PDDs on the average of two and nine-tenths (2.9) seconds with ninety-five (95%) in  $\leq$  six and one-half (6.5) seconds.

#### **15.2.4.5.5.2.4 Impact of Number Portability ("NP")**

If a call forwarding option is used as an interim solution for NP, the delay due to additional switching in the local access shall not exceed 0.4 seconds (95th percentile) in addition to the PDDs described above.

#### **15.2.4.5.5.2.5 Custom Local Area Subscriber Services ("CLASS")**

CLASS<sup>SM</sup> features such as Calling Name Delivery can contribute to the PDD of a call. This delay is caused by the additional time (Sprint option) before the ringing interval commences. This default delay is three (3) seconds. Optional settings are available in one (1) second intervals from one (1) to six (6) seconds. Calls to DTNs that have CLASS<sup>SM</sup> features, particularly with calling name delivery, can expect to experience from one (1) to six (6) seconds (three (3) seconds default) of additional PDD compared to the PDDs shown for PDD1-C. MCI will specify optimal settings.

#### **15.2.4.5.5.2.6 Partial Dial Timing**

15.2.4.5.5.2.6.1 The interval between each information digit from a subscriber's line, until the LSO or switching system has determined that the digit string is incomplete.

15.2.4.5.5.2.6.2 For customer lines, Partial Dial Timing shall be  $\geq$  sixteen (16) seconds and  $<$  twenty-four (24) seconds. For trunks, inband signaling time-out shall be  $\geq$  five (5) seconds and  $<$  twenty (20) seconds.

#### **15.2.4.6 Local Switching**

Sprint shall provide Performance equal to or better than [in accordance with] the requirements for Local Switching set forth in Bellcore LSSGR TR-TSY-000511. Post Dial Delay for connections to MCI local Operator Services shall be no worse than Operator Services provided by Sprint. Additionally, Post Dial Delay from the Operator Services to destination numbers shall be no worse than that provided by Sprint. Post Dial Delay for connections to MCI local directory services shall be no worse than directory services provided by Sprint. Additionally, Post Dial Delay from the directory system to destination numbers shall be no worse than that provided by Sprint.

#### **15.2.4.7 Operator Systems**

Operator System connections shall comply with the requirements for the Loop Combination, Local Switching, Operator Service, and Directory Assistance Service requirements.

#### **15.2.4.8 Common Transport**

Specific requirements for this Network Element or Ancillary Function are in the Common Transport Section. In all cases the Performance of this Network Element shall meet the general requirements stated in "General Performance Requirements." Allocation of impairments shall be negotiated between MCI and Sprint consistent with sound engineering principles.

#### **15.2.4.9 Dedicated Transport**

Specific requirements for this Network Element are in the Dedicated Transport Section. In all cases the Performance of this Network Element shall meet the general requirements stated in "General Performance Requirements." (Allocation of impairments shall be negotiated between MCI and Sprint consistent with sound engineering principles.)

#### **15.2.4.10 Signaling Transfer Points**

Specific requirements for this Network Element are in the Signaling Transfer Points Section. In all cases the

Performance of this Network Element shall meet the general requirements stated in "General Performance Requirements." (Allocation of impairments shall be negotiated between MCI and Sprint.)

#### **15.2.4.11 Signaling Link Transport**

Specific requirements for this Network Element are in the Signaling Link Transport Section. In all cases the Performance of this Network Element shall meet the general requirements stated in "General Performance Requirements." Allocation of impairments shall be negotiated between MCI and Sprint consistent with sound engineering principles.

#### **15.2.4.12 SCPs/Databases**

The Performance requirements for databases (NP, LIDB, E911, etc.) vary depending on the database and the applications it supports. Database-specific Performance requirements are included in the Sections addressing individual Network Elements and in applicable Bellcore documents. In all cases, the query response time, availability, accuracy, updating capabilities, and other Performance parameters shall at least be at Parity with those services as provided to Sprint or other subscriber.

#### **15.2.4.13 Tandem Switching**

Specific requirements for this Network Element are in the Tandem Switching Section. In all cases the Performance of this Network Element shall meet the general requirements stated in "General Performance Requirements." Allocation of impairments shall be negotiated between MCI and Sprint consistent with sound engineering principles.

### **15.2.5 Test and Verification**

**15.2.5.1** Sprint shall permit MCI to confirm acceptable Performance of any Network Element.

**15.2.5.1.1** At MCI's request, Sprint will provide access to the Network Element sufficient for MCI to test the Performance of that Network Element to MCI's satisfaction.



15.2.5.1.2 At MCI's request, Sprint will perform tests to confirm acceptable Performance and provide MCI with documentation of test procedures and results acceptable to MCI.

### **15.3 Protection, Restoration, and Disaster Recovery**

#### **15.3.1 Scope**

This Section refers specifically to requirements on the use of redundant network equipment and facilities for protection, restoration, and disaster recovery.

#### **15.3.2 Requirements**

15.3.2.1 Sprint shall provide protection, restoration, and disaster recovery capabilities at Parity with those capabilities provided for their own services, facilities and equipment (e.g., equivalent circuit pack protection ratios, and facility protection ratios).

15.3.2.2 Sprint shall provide Network Elements and Ancillary Functions equal priority in protection, restoration, and disaster recovery as provided to their own services, facilities and equipment.

15.3.2.3 Sprint shall provide Network Elements and Ancillary Functions equal priority in the use of spare equipment and facilities as provided to their own services, facilities and equipment.

15.3.2.4 Sprint shall restore Network Elements which are specific to MCI end user subscribers on a priority basis as MCI may designate.

### **15.4 Synchronization**

#### **15.4.1 Definition**

Synchronization is the function which keeps all digital equipment in a communications network operating at the same average frequency. With respect to digital transmission, information is coded into discrete pulses. When these pulses are transmitted through a digital communications network, all synchronous Network Elements are traceable to a stable and accurate timing source.

Network synchronization is accomplished by timing all synchronous Network Elements in the network to a stratum one (1) source so that transmission from these network points have the same average line rate.

#### **15.4.2 Technical Requirements**

The following requirements are applicable to the case where Sprint provides synchronization to equipment that MCI owns and operates within a Sprint location. In addition, these requirements apply to synchronous equipment that is owned by Sprint and is used to provide a Network Element to MCI.

**15.4.2.1** The synchronization of clocks within digital networks is divided into two (2) parts: intra-building and inter-building. Within a building, a single clock is designated as the Building Integrated Timing Supply ("BITS"), which provides all of the DS1 and DS0 synchronization references required by other clocks in such building. This is referred to as intra-building synchronization. The BITS receives synchronization references from remotely-located BITS. Synchronization of BITS between buildings is referred to as inter-building synchronization.

**15.4.2.2** To implement a network synchronization plan, clocks within digital networks are divided into four (4) stratum levels. All clocks in strata 2, 3, and 4 are synchronized to a stratum 1 clock, that is, they are traceable to a stratum 1 clock. A traceable reference is a reference that can be traced back through some number of clocks to a stratum 1 source. Clocks in different strata are distinguished by their free running accuracy or by their stability during trouble conditions such as the loss of all synchronization references.

##### **15.4.2.2.1 Intra-Building**

**15.4.2.2.1.1** Within a building, there may be different kinds of equipment that require synchronization at the DS1 and DS0 rates. Synchronization at the DS1 rate is accomplished by the frequency synchronizing presence of buffer stores at various DS1 transmission interfaces. Synchronization at the DS0 rate is accomplished by using a

composite clock signal that phase synchronizes the clocks. Equipment requiring DS0 synchronization frequently does not have adequate buffer storage to accommodate the phase variations among different equipment. Control of phase variations to an acceptable level is accomplished by externally timing all interconnecting DS0 circuits to a single clock source and by limiting the interconnection of DS0 equipment to less than 1,500 cable feet. Therefore, a BITS shall provide DS1 and composite clock signals when the appropriate composite signal is a 64-kHz 5/8<sup>th</sup> duty cycle, return to zero with a bipolar violation every eighth pulse (B8RZ).

#### **15.4.2.2.2 Inter-Building**

15.4.2.2.2.1 Sprint shall provide inter-building synchronization at the DSI rate, and the BITS shall accept the primary and secondary synchronization links from BITS in other buildings. From hierarchical considerations, the BITS shall be the highest stratum clock within the building and Sprint shall provide operations capabilities (this includes, but is not limited to: synchronization reference provisioning; synchronization reference status inquiries; timing mode status inquiries; and alarm conditions).

#### **15.4.3 Synchronization Distribution Requirements**

15.4.3.1 Central Office BITS shall contain redundant clocks meeting or exceeding the requirements for a stratum 2 clock, or such clock as Sprint has, as specified in ANSI T1.101-1994 and Bellcore TR-NWT-001244 Clocks for the Synchronized Network: Common Generic Criteria.

15.4.3.2 Where available, Central Office BITS shall be powered by primary and backup power sources.

15.4.3.3 If both reference inputs to the BITS are interrupted or in a degraded mode (meaning off frequency greater than twice the minimum accuracy of the BITS, loss of frame,

excessive bit errors, or in Alarm Indication Signal), then the stratum clock in the BITS shall provide the necessary bridge in timing to allow the network to operate without a frame repetition or deletion (slip free) with Performance as set forth in applicable industry standards.

15.4.3.4 DS1s multiplexed into a SONET synchronous payload envelope within an STS-n (where n is defined in ANSI T1.105-1995) signal shall not be used as reference facilities for network synchronization.

15.4.3.5 The total number of Network Elements cascaded from the stratum 1 source shall be minimized.

15.4.3.6 A Network Element shall receive the synchronization reference signal only from another Network Element that contains a clock of equivalent or superior quality (stratum level).

15.4.3.7 Sprint shall select for synchronization those facilities shown to have the greatest degree of availability (absence of outages).

15.4.3.8 Where possible, all primary and secondary synchronization facilities shall be physically diverse (this means the maximum feasible physical separation of synchronization equipment and cabling).

15.4.3.9 No timing Loops shall be formed in any combination of primary and secondary facilities.

15.4.3.10 Where available, an Operations Support System ("OSS") shall continuously monitor the BITS for synchronization-related failures or degradation.

15.4.3.11 Where available, an OSS shall continuously monitor all equipment transporting synchronization facilities for synchronization-related failures or degradation.

15.4.3.12 For non-SONET equipment, Sprint shall provide synchronization facilities which, at a minimum, comply with the standards set forth in ANSI T1.101-1994.

15.4.3.13 For SONET equipment, Sprint shall provide synchronization facilities that have time deviation ("TDEV")

for integration in compliance with Bellcore and ANSI standards.

## 15.5 SS7 Network Interconnection

### 15.5.1 Definition

Figure 7 depicts Signaling System 7 ("SS7") Network Interconnection. SS7 Network Interconnection is the interconnection of MCI local Signaling Transfer Point ("STPs") with Sprint STPs. This interconnection provides connectivity that enables the exchange of SS7 messages among Sprint switching systems and databases ("DBs"), MCI local or tandem switching systems, and other third party switching systems directly connected to the Sprint SS7 network.

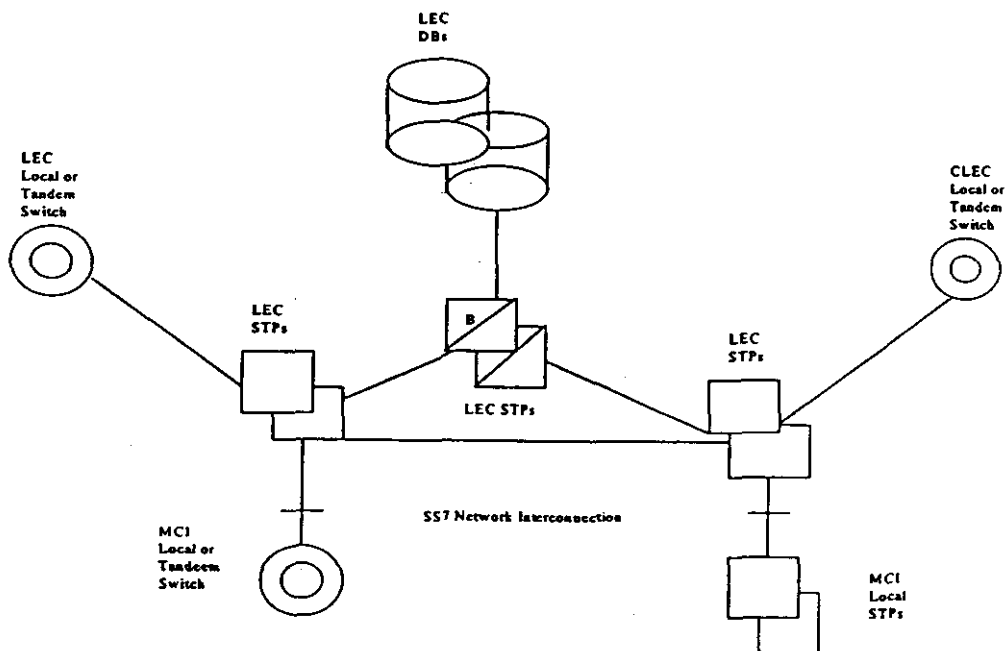

Figure 7. SS7 Network Interconnection

### 15.5.2 Technical Requirements

15.5.2.1 SS7 Network Interconnection shall provide signaling connectivity to all components of the Sprint SS7 network. These include:

15.5.2.1.1 Sprint local or tandem switching systems;

15.5.2.1.2 Sprint SCP databases; and

15.5.2.1.3 Other third party local or tandem switching systems.

15.5.2.2 The connectivity provided by SS7 Network Interconnection shall fully support the functions of Sprint switching systems and databases and MCI or other third party switching systems that are connected with A-link access to the Sprint SS7 network.

15.5.2.3 In particular, Figure 8 depicts a circumstance where SS7 Network Interconnection shall provide transport for certain types of transaction capabilities application part ("TCAP") messages. If traffic is routed based on dialed or translated digits between an MCI Local Switching system and a Sprint or other third party Local Switching system, either directly or via a Sprint tandem switching system, then, at Parity to itself and where available, that the Sprint SS7 network shall convey via SS7 Network Interconnection the TCAP messages that are necessary to provide Call Management services (Automatic Callback, Automatic Recall, and Screening List Editing) between the MCI local STPs and the Sprint or other third party local Switch.

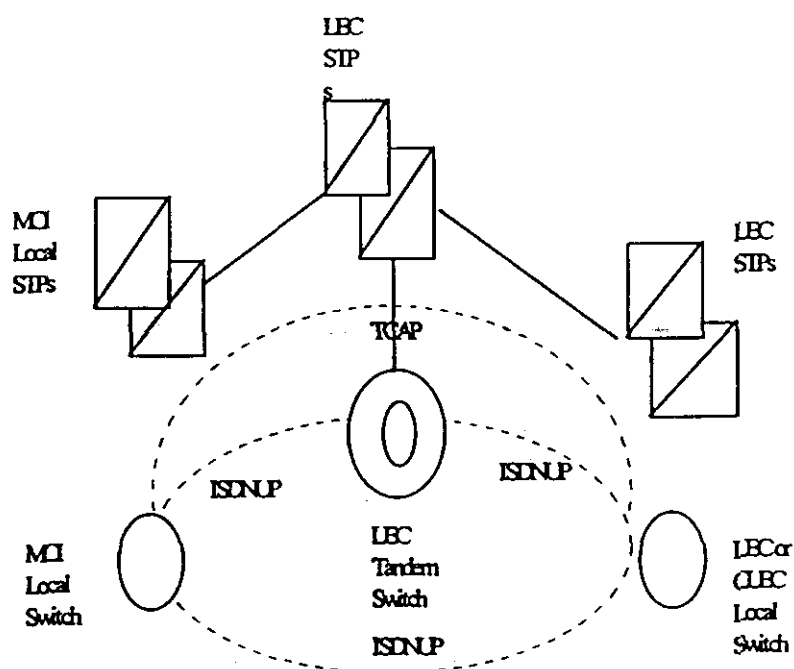

**Figure 8. Interswitch TCAP Signaling for SS7 Network Interconnection**

15.5.2.4 When the capability to route messages based on Intermediate Signaling Network Identifier ("ISNI") is generally available on Sprint STPs, the Sprint SS7 Network shall also convey TCAP messages using SS7 Network Interconnection in similar circumstances where the Sprint Switch routes traffic based on a Carrier Identification Code ("CIC").

15.5.2.5 SS7 Network Interconnection shall provide all functions of the MTP as specified in ANSI T1. 111, (Reference 12.5.2). This includes:

15.5.2.5.1 Signaling Data Link functions, as specified in ANSI T1.111.2;

15.5.2.5.2 Signaling Link functions, as specified in ANSI T1.111.3; and

15.5.2.5.3 Signaling Network Management functions, as specified in ANSI T1.111.4.

15.5.2.6 SS7 Network Interconnection shall provide all functions of the SCCP necessary for Class 0 (basic connectionless) service, as specified in ANSI T1.112 (Reference 12.5.4). In particular, this includes Global Title Translation ("GTT") and SCCP Management procedures, as specified in T1.112.4.

15.5.2.7 Where the destination signaling point is a Sprint switching system or DB, or is another third party local or tandem switching system directly connected to the Sprint SS7 network, SS7 Network Interconnection shall include final GTT of messages to the destination and SCCP Subsystem Management of the destination.

15.5.2.8 Where the destination signaling point is an MCI local or tandem switching system, SS7 Network Interconnection shall include intermediate GTT of messages to a Gateway pair of MCI local STPs, and shall not include SCCP Subsystem Management of the destination.

15.5.2.9 SS7 Network Interconnection shall provide all functions of the Integrated Services Digital Network User Part ("ISDNUP"), as specified in ANSI T1.113.

15.5.2.10 SS7 Network Interconnection shall provide all functions of the TCAP, as specified in ANSI T1.114.

15.5.2.11 If and when Internetwork MTP Routing Verification Test ("MRVT") and SCCP Routing Verification Test ("SRVT") become approved ANSI standards and available capabilities of Sprint STPs, SS7 Network Interconnection shall provide these functions of the OMAP.

15.5.2.12 SS7 Network Interconnection shall be equal to or better than the following Performance requirements:

15.5.2.12.1 MTP Performance, as specified in ANSI T1.111.6;

15.5.2.12.2 SCCP Performance, as specified in ANSI T1.112.5; and

15.5.2.12.3 ISDNUP Performance, as specified in ANSI T1.113.5.



### 15.5.3 Interface Requirements

15.5.3.1 Sprint shall offer the following SS7 Network Interconnection options to connect MCI or MCI-designated STPs to the Sprint SS7 network:

15.5.3.1.1 D-link interface from MCI STPs.

15.5.3.2 Each interface shall be provided by one or more sets (layers) of signaling links, as follows:

15.5.3.2.1 A D-link layer shall consist of four (4) links, as depicted in Figure 9.

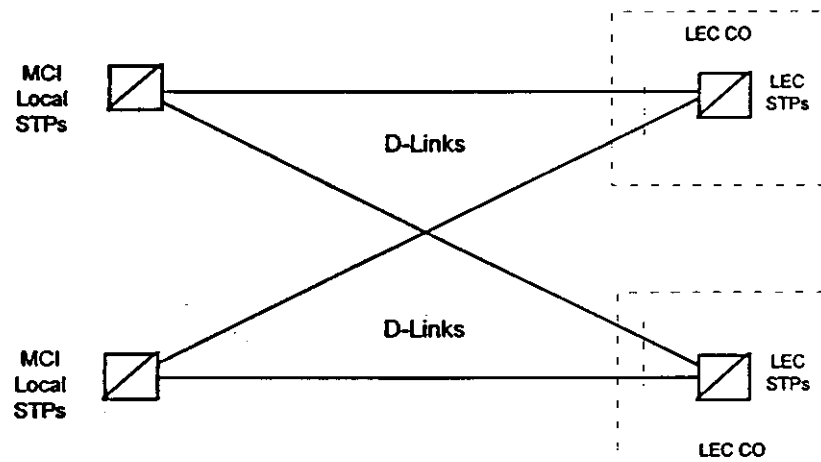

Figure 9. D-LINK Interface

15.5.3.3 The Signaling Point of Interconnection ("SPOI") for each link shall be located at a cross-connect element, including, but not limited to, a DSX-1, in the Central Office ("CO") where the Sprint STPs is located. There shall be a DS1 or higher rate transport interface at each of the SPOIs. Each signaling link shall appear as a DS0 channel within the DS1 or higher rate interface. Sprint shall offer higher rate DS1 signaling links for interconnecting MCI Local Switching systems or STPs with Sprint STPs as soon as these become approved ANSI standards and available capabilities of Sprint STPs.

15.5.3.3.1 MCI and Sprint shall mutually develop a plan for interconnection of their signaling networks. The number and location of the Signaling Points of

Interconnection ("SPOIs") as well as the requirements for link diversity will be specified in said plan. The Parties shall agree upon a plan that is reasonable and efficient for both Parties.

15.5.3.3.2 Each Party will designate one of the two SPOIs in the LATA. A SPOI can be any existing cross-connect point in the LATA. Since each Party will designate a SPOI, both Parties will have the incentive to select reasonable and efficient SPOI locations.

15.5.3.3.3 Each signaling link requires a port on each Party's STP at rates as specified in Attachment I.

15.5.3.4 Where physical diversity is available, the Sprint CO shall provide intraoffice diversity between the SPOIs and the Sprint STPs, so that no single failure of intraoffice facilities or equipment shall cause the failure of both B or D-links in a layer connecting to a Sprint STPs.

15.5.3.5 The protocol interface requirements for SS7 Network Interconnection include the MTP, ISDNUP, SCCP and TCAP. These protocol interfaces shall conform to the following specifications:

15.5.3.5.1 Bellcore GR-905-CORE, Common Channel Signaling Network Interface Specification ("CCSNIS") Supporting Network Interconnection, Message Transfer Part ("MTP"), and Integrated Services Digital network User Part ("ISDNUP");

15.5.3.5.2 Bellcore GR-1428-CORE, CCS Network Interface Specification ("CCSNIS") Supporting toll free service;

15.5.3.5.3 Bellcore GR-1429-CORE, CCS Network Interface Specification ("CCSNIS") Supporting Call Management Services; and

15.5.3.5.4 Bellcore GR-1432-CORE, CCS Network Interface Specification ("CCSNIS") Supporting Signaling Connection Control Part ("SCCP") and Transaction Capabilities Application Part ("TCAP").



15.5.3.5.5 Sprint shall set message screening parameters to accept messages at MCI's instructions from MCI's local or tandem switching systems destined to any signaling point in the Sprint SS7 network with which the MCI switching system has a legitimate signaling relation.

15.5.4 SS7 Network Interconnection shall be equal to or better than all of the requirements for SS7 Network Interconnection set forth in the following technical references:

15.5.4.1 ANSI T1.110-1992 American National Standard Telecommunications Signaling System Number 7 ("SS7") - General Information;

15.5.4.2 ANSI T1.111-1992 American National Standard for Telecommunications - Signaling System Number 7 ("SS7") - Message Transfer Part ("MTP");

15.5.4.3 ANSI T1.111A-1994 American National Standard for Telecommunications - Signaling System Number 7 ("SS7") - Message Transfer Part ("MTP") Supplement;

15.5.4.4 ANSI T1.112-1992 American National Standard for Telecommunications - Signaling System Number 7 ("SS7") - Signaling Connection Control Part ("SCCP");

15.5.4.5 ANSI T1.113-1995 American National Standard for Telecommunications - Signaling System Number 7 ("SS7") - Integrated Services Digital Network ("ISDN") User Part;

15.5.4.6 ANSI T1.114-1992 American National Standard for Telecommunications - Signaling System Number 7 ("SS7") - Transaction Capabilities Application Part ("TCAP");

15.5.4.7 ANSI T1.115-1990 American National Standard for Telecommunications - Signaling System Number 7 ("SS7") - Monitoring and Measurements for Networks;

15.5.4.8 ANSI T1.116-1990 American National Standard for Telecommunications - Signaling System Number 7 ("SS7") - Operations, Maintenance and Administration Part ("OMAP");

15.5.4.9 ANSI T1.118-1992 American National Standard for Telecommunications - Signaling System Number 7 ("SS7") - Intermediate Signaling Network Identification ("ISNI");

15.5.4.10 Bellcore GR-905-CORE, Common Channel Signaling Network Interface Specification ("CCSNIS") Supporting Network Interconnection, Message Transfer Part ("MTP"), and Integrated Services Digital Network User Part ("ISDNUP");

15.5.4.11 Bellcore GR-954-CORE, CCS Network Interface Specification ("CCSNIS") Supporting Line Information Database ("LIDB") Service;

15.5.4.12 Bellcore GR-1428-CORE, CCS Network Interface Specification ("CCSNIS") supporting toll free service;

15.5.4.13 Bellcore GR-1429-CORE, CCS Network Interface Specification ("CCSNIS") Supporting Call Management Services; and

15.5.4.14 Bellcore GR-1432-CORE, CCS Network Interface Specification ("CCSNIS") Supporting Signaling Connection Control Part ("SCCP") and Transaction Capabilities Application Part ("TCAP").

**15.6 Network Interconnection [NOTE: This Section covers Network Elements purchased from Sprint used in MCI's network to support interconnection, not Sprint's interconnection trunks.]**

**15.6.1 Technical Requirements**

15.6.1.1 When requested by MCI, Sprint shall provide interconnections between the Sprint Network Elements provided to MCI and MCI's network at transmission rates agreed upon by MCI and Sprint, (e.g., DSO, DS1, DS3 and SONET).

15.6.1.2 Traffic shall be combined and routed as follows:

15.6.1.2.1 Sprint shall provide direct trunks for IntraLATA traffic (except 911, directory assistance, Operator Services, and other services that may require special routing) and, at MCI's request, Sprint shall allow MCI to route such traffic either directly to

a Sprint tandem or directly to a Sprint end office. At MCI's option, IntraLATA toll and Local Traffic shall be combined onto one trunk group.

15.6.1.2.2 At MCI's request, Sprint shall receive MCI traffic destined to the Sprint Operator Systems Network Element, on trunks from an MCI end office or an MCI tandem.

15.6.1.2.3 At MCI's request, Sprint shall receive MCI CAMA-ANI ("Centralized Automatic Message Accounting - Automatic Number Identification") traffic destined to the Sprint B911 PSAPs, or E911 tandems, on trunks from an MCI end office.

15.6.1.2.4 Where deployed and at MCI's request, Sprint shall receive MCI SS7 traffic destined to any Sprint S911 tandem on trunks from an MCI end office.

15.6.1.3 When requested by MCI and a third party carrier, Sprint shall provide interconnections between MCI's network, and the other carrier's network through the Sprint network at transmission rates designated by MCI, including, but not limited to, DS1, DS3, and STS-1. Sprint shall combine and route traffic to and from other local carriers and InterLATA carriers through the Sprint network, and at MCI's request, Sprint shall record and keep records of such traffic for MCI billing purposes, where Technically Feasible.

15.6.1.4 Sprint shall provide two-way trunk groups for interconnections. At MCI's request, Sprint shall provide unidirectional traffic on such trunks, in either direction, effectively operating them as if they were one-way trunk groups.

15.6.1.5 Sprint shall provision trunks without any user restrictions (e.g., option for two-way trunking, and no restrictions by traffic types).

15.6.1.6 All trunking provided by Sprint shall adhere to the applicable Performance requirements set forth in the "General Performance Requirements" Section 15 of this Attachment.

15.6.1.7 At MCI's request, Sprint shall provide for overflow routing from a given trunk group or groups onto another trunk group or groups as MCI designates.

15.6.1.8 Sprint and MCI shall agree on the establishment of two-way trunk groups for the exchange of traffic for other IXCs. These trunk groups can be provided in a "meet point" arrangement.

15.6.1.9 Interconnection shall be made available upon MCI's request at any Technically Feasible point of interface. All trunk interconnections shall be provided, including, SS7, MF, DTMF, DialPulse, PRI-ISDN (where available), DID (Direct Inward Dialing), CAMA-ANI, and trunking necessary so that interim NP can be provided.

#### **15.6.1.10 Trunk Interface Requirements**

##### **15.6.1.10.1 B911/E911 Trunks**

15.6.1.10.1.1 Sprint shall allow MCI to provide direct trunking to each Sprint B911 serving end office, or Sprint E911 tandem, as is appropriate for the applicable serving area. These trunks are to be provided as one-way trunks from a given MCI end office to the Sprint 911 end office or tandem.

15.6.1.10.1.2 Sprint shall provide for overflow 911 traffic to be sent to the Sprint Operator Services platform or, at MCI's direction, routed directly to MCI's Operator Services platform to be handled in the same manner as Sprint handles its own end users or others.

##### **15.6.1.10.2 S911 Trunks**

In areas where S911 tandems are used, Sprint shall allow MCI to provide direct trunking to each Sprint S911 tandem. Such SS7 trunks are to be provided as one-way trunks from a given MCI end office to the Sprint S911 tandem.

**15.6.1.10.3 Local Switch and Access Tandem Trunks**

15.6.1.10.3.1 Sprint shall provide trunks groups provisioned exclusively to carry IntraLATA traffic, as designated by MCI.

15.6.1.10.3.2 Sprint shall provide trunk groups provisioned exclusively to carry InterLATA traffic, as designated by MCI.

15.6.1.10.3.3 Sprint shall provide SS7 trunks which provide SS7 interconnection. At MCI's request, MF trunks may be substituted for SS7 trunks where applicable.

15.6.1.10.3.4 Sprint shall simultaneously route calls based on dialed digits (in accordance with the standard GR-317-CORE), and Carrier Identification Code (in accordance with the standard GR-394-CORE) over a single SS7 trunk group.

**15.6.1.10.4 Sprint Operator Services Trunk**

15.6.1.10.4.1 For traffic from the Sprint network to MCI for Operator Services, Sprint shall provide one trunk group per NPA served by the local Sprint Switch.

15.6.1.10.4.2 Sprint shall provide such trunks as one-way trunks from the Sprint network to the MCI network.

15.6.2 Network Interconnection between Sprint and MCI shall meet or exceed all of the requirements for Network Interconnection set forth in the following technical references:

15.6.2.1 GR-317-CORE, Switching System generic requirements for Call Control Using the Integrated Services Digital Network User Part ("ISDNUP"), Bellcore, February, 1994;

15.6.2.2 GR-394-CORE, Switching System generic requirements for Interexchange Carrier Interconnection



Using the Integrated Services Digital Network User Part ("ISDNUP"), Bellcore, February, 1994;

15.6.2.3 FR-NWT-000271, OSSGR Operator Services Systems generic requirements, Bellcore, 1994 Edition; and

15.6.2.4 FR-NWT-000064, LATA Switching Systems Generic Requirements ("LSSGR"), Bellcore, 1994 Edition.

***Section 16. Basic 911 and E911***

See Attachment VIII, Section 6.1.1, 911 General Requirements and Section 6.2.1, 911 System Interface and Exchanges.

***Section 17. Directory Assistance Data***

See Attachment VIII, Section 6.1.6, Directory Assistance Data General Requirements and Section 6.2.2, Directory Assistance Data Interfaces and Exchanges.

**TABLE OF CONTENTS**

**Attachment IV  
INTERCONNECTION**

Section 1.	Local Interconnection Trunk Arrangement	IV-1
Section 2.	Compensation Mechanisms	IV-2
Section 3.	Signaling	IV-4
Section 4.	Network Servicing	IV-5
Section 5.	Network Management	IV-8
Section 6.	Busy Line Verify and Interrupt	IV-8
Section 7.	Usage Measurement	IV-9
Section 8.	Responsibilities of the Parties	IV-9

## ATTACHMENT IV

### INTERCONNECTION

#### **Section 1. Local Interconnection Trunk Arrangement**

1.1 The Parties shall initially reciprocally terminate Local Traffic and IntraLATA/InterLATA toll calls originating on each other's networks as follows:

1.1.1 The Parties shall make available to each other two-way trunks for the reciprocal exchange of combined Local Traffic, non-equal access IntraLATA toll traffic, and local transit traffic to other ILECs.

1.1.2 Separate two-way trunks will be made available for the exchange of equal access InterLATA or IntraLATA interexchange traffic that transits Sprint's network. Upon agreement between MCI and Sprint, equal access InterLATA and/or IntraLATA traffic may be combined on the same trunk group as Local Traffic, non-equal access IntraLATA toll traffic, and local transit traffic.

1.1.3 Separate trunks connecting MCI's Switch to each 911/E911 tandem.

1.1.4 Separate trunk group connecting MCI's Switch to Sprint's Operator Service center for operator-assisted busy line interrupt/verify. MCI, at its option, may establish trunks from its own Operator Services platform directly to Sprint's Operator Service center.

1.1.5 Separate trunk group connecting MCI's Switch to Sprint's directory assistance center in instances where MCI is purchasing Sprint's unbundled directory assistance service.

1.1.6 It is recognized by the Parties that there is no technical requirement to segregate local and interexchange traffic. Further, it shall be incumbent upon the Party receiving the request to prove that a request for a revised traffic combination is technically infeasible.

## **1.2 Interconnection Point**

1.2.1 "Interconnection Point" or "IP" means the physical point that establishes the technical interface, the test point, and the operational responsibility hand-off between MCI and Sprint for the local interconnection of their networks.

1.2.2 MCI shall designate at least one (1) physical IP in the LATA (of which one (1) IP shall be a tandem office or from a location which MCI purchases transport to such tandem office, unless otherwise mutually agreed by the Parties) in which MCI originates Local Traffic and interconnects with Sprint. MCI will be responsible for engineering and maintaining its network on its side of the IP. Sprint will be responsible for engineering and maintaining its network on its side of the IP. If and when the Parties choose to interconnect at a mid-span meet, MCI and Sprint will jointly provision the facilities that connect the two (2) networks. Sprint will be required to provide either fifty percent (50%) of the facilities or to its exchange boundary, whichever is less. MCI will be required to provide either fifty percent (50%) of the facilities or to Sprint's exchange boundary, whichever is greater.

1.2.2.1 Upon MCI's request for additional points of interconnection, Sprint will interconnect with MCI at any Technically Feasible point of MCI's choosing.

1.2.2.2 Any end office not subtending Sprint's tandem Switch will require provisioning of a separate IP or purchase of transport to an existing IP if such transport is available, by MCI to terminate traffic to such end office.

## **Section 2. Compensation Mechanisms**

### **2.1 Interconnection Point**

2.1.1 Each Party is responsible for bringing its facilities to the IP.

### **2.2 Compensation for Call Traffic Transport and Termination**

2.2.2 The IP determines the point at which the originating carrier shall pay the terminating carrier for the completion of that traffic. The following compensation elements shall apply:

2.2.2.1 "Transport", which includes the two (2) rate elements of transmission and any necessary tandem switching of Local Traffic from the interconnection point between the two (2) carriers to the terminating carrier's end office Switch that directly serves the called end user.

2.2.2.2 "Termination", which includes the switching of Local Traffic at the terminating carrier's end office Switch.

2.3 When an MCIIm subscriber places a call to Sprint subscribers, MCIIm will hand off that call to Sprint at the IP. Conversely, when Sprint hands over Local Traffic to MCIIm for MCIIm to transport and terminate, Sprint must use an established IP within the LATA for a minimum of twelve (12) months from the time that interconnection is established. After the twelve (12) month period Sprint may, with MCIIm's agreement, establish an alternate IP of its choosing that the parties will use for Sprint's Local Traffic to MCIIm. Should Sprint and MCIIm be unable to agree to the establishment of Sprint's alternate IP, then Sprint may invoke the Dispute Resolution Procedure as set forth in Section 23 of Part A of this Agreement.

2.4 MCIIm may designate an IP at any Technically Feasible point including, but not limited to, any electronic or manual cross-connect points, Collocations, entrance facilities, and mid-span meets. The transport and termination charges for Local Traffic flowing through an IP shall be as follows:

2.4.1 When calls from MCIIm are terminating on Sprint's network through the Sprint tandem, MCIIm will pay to Sprint transport charges from the IP to the tandem for dedicated or common transport. MCIIm shall also pay a charge for tandem switching, dedicated or common transport to the end office, and end office termination.

2.4.2 When Sprint terminates calls to MCIIm's subscribers using MCIIm's Switch, Sprint shall pay to MCIIm transport charges from the IP to the MCIIm switching center for dedicated or common transport. Sprint shall also pay to MCIIm a charge symmetrical to its own charges for the functionality actually provided by MCIIm.

2.4.3 MCIIm may choose to establish direct trunking to any given end office. If MCIIm leases trunks from Sprint, it shall pay charges for dedicated or common transport. For calls terminating from MCIIm to subscribers served by these directly-trunked end offices, MCIIm shall also pay for end office termination. For Sprint traffic

terminating to MCI<sub>m</sub> over the direct end office trunking, compensation payable by Sprint shall be the same as that detailed in Section 2.4.2 above.

### **Section 3. Signaling**

**3.1 Signaling protocol.** The Parties will interconnect their networks using SS7 signaling where Technically Feasible and available as defined in FR 905 Bellcore Standards including ISDN user part ("ISUP") for trunk signaling and transaction capabilities application part ("TCAP") for CCS-based features in the interconnection of their networks. All Network Operations Forum ("NOF") adopted standards shall be adhered to.

**3.2** The Parties will provide CCS to each other in conjunction with all trunk groups supporting Local Traffic and transit and toll traffic, except for known limitations with INP trunking. The Parties will cooperate on the exchange of TCAP messages to facilitate full inter-operability of CCS-based features between their respective networks, including all CLASS features and functions. All available CCS signaling parameters will be provided including ANI, originating line information ("OLI"), calling party category, Charge Number, etc. All privacy indicators will be honored. For terminating FGD, Sprint will pass CPN if it receives CPN from FGD carriers. All privacy indicators will be honored. Where available, network signaling information such as transit network selection ("TNS") parameter (CCS platform) and CIC/OZZ information (non-CCS environment) will be provided by MCI<sub>m</sub> wherever such information is needed for call routing or billing. The Parties will follow all OBF adopted standards pertaining to TNS and CIC/OZZ codes.

**3.3** Refer to Attachment III, Section 15.5 for detailed terms of SS7 Network Interconnection.

**3.4** Standard interconnection facilities shall be extended superframe ("ESF") with B8ZS line code. Where ESF/B8ZS is not available, MCI<sub>m</sub> will agree to using other interconnection protocols on an interim basis until the standard ESF/B8ZS is available. Sprint will provide anticipated dates of availability for those areas not currently ESF/B8ZS compatible.

**3.4.1** Where MCI<sub>m</sub> is unwilling to utilize an alternate interconnection protocol, MCI<sub>m</sub> will provide Sprint an initial forecast of 64 Kbps clear channel capability ("64K CCC") trunk quantities within thirty (30) days of executing this Agreement consistent with the forecasting agreements between the Parties. Upon receipt of this forecast, the Parties will begin joint planning for the engineering, procurement, and installation of the segregated 64K

CCC local interconnection trunk groups, and the associated B8ZS extended super frame ("ESF") facilities, for the sole purpose of transmitting 64K CCC data calls between MCI and Sprint. Where additional equipment is required, such equipment would be obtained, engineered, and installed on the same basis and with the same intervals as any similar growth job for IXC, CLEC, or Sprint internal customer demand for 64K CCC trunks. Where Technically Feasible, these trunks will be established as two-way.

#### **Section 4. Network Servicing**

##### **4.1 Trunk Forecasting**

4.1.1 The Parties shall work towards the development of joint forecasting responsibilities for traffic utilization over trunk groups. Orders for trunks that exceed forecasted quantities for forecasted locations will be accommodated as facilities and/or equipment are available. Parties shall make all reasonable efforts and cooperate in good faith to develop alternative solutions to accommodate orders when facilities are not available. Intercompany forecast information must be provided by the Parties to each other twice a year. The semi-annual forecasts shall include:

4.1.1.1 Yearly forecasted trunk quantities (which include baseline data that reflect actual tandem and end office Local Interconnection and meet point trunks and tandem-subtending Local Interconnection end office equivalent trunk requirements for no more than two (2) years (current plus one (1) year));

4.1.1.2 The use of Common Language Location Identifier ("CLLI-MSG"), which are described in Bellcore documents BR 795-100-100 and BR 795-400-100; and

4.1.1.3 Description of major network projects that affect the other Party will be provided in the semi-annual forecasts. Major network projects include, but are not limited to, trunking or network rearrangements, shifts in anticipated traffic patterns, or other activities by either Party that are reflected by a significant increase or decrease in trunking demand for the following forecasting period.

4.1.2 Parties shall meet to review and reconcile their forecasts if forecasts vary significantly.

4.1.2.1 If the Parties are unable to reach such a reconciliation, the local interconnection trunk groups shall be provisioned to the higher forecast. At the end of three (3) months, the utilization of the local interconnection trunk groups will be reviewed and if the average centi call seconds ("CCS") utilization for the third month is under seventy-five percent (75%) of capacity, either Party may issue an order to resize the trunk group.

4.1.2.2 If the Parties agree on the original forecast and then it is determined that a trunk group is under seventy-five percent (75%) of centi call seconds ("CCS") capacity on a monthly-average basis for each month of any six (6) month period, either Party may issue an order to resize the trunk group.

4.1.3 Each Party shall provide a specified point of contact for planning, forecasting and trunk servicing purposes.

4.1.4 Trunking can be established to tandems or end offices or a combination of both via either one-way or two-way trucks. Trunking will be at the DS-0 level, DS-1 level, DS-3/OC-3 level, or higher, as agreed upon by MCI and Sprint. Initial trunking will be established between the MCI switching centers and Sprint's access tandem(s). The Parties will utilize direct end office trunking under the following conditions:

4.1.4.1 **Tandem Exhaust.** If a tandem through which the Parties are interconnected is unable to, or is forecasted to be unable to, support additional traffic loads for any period of time, the Parties will mutually agree on an end office trunking plan that will alleviate the tandem capacity shortage and ensure completion of traffic between MCI and Sprint subscribers.

4.1.4.2 **Traffic Volume.** The Parties shall install and retain direct end office trunking sufficient to handle actual or reasonably forecast traffic volumes, whichever is greater, between an MCI switching center and a Sprint end office where the traffic exceeds or is forecast to exceed 220,000 minutes of Local Traffic per month. The Parties will install additional capacity between such points when overflow traffic between the MCI switching center and Sprint access tandem exceeds or is forecast to exceed 220,000 minutes of Local Traffic per month unless otherwise mutually agreed.



**4.1.4.3 Mutual Agreement.** The Parties may install direct end office trunking upon mutual agreement in the absence of the conditions set forth in Subsections 4.1.4.1 and 4.1.4.2 above and agreement will not unreasonably be withheld.

## **4.2 Grade of Service**

**4.2.1** A blocking standard of one percent (1%) during the average busy hour, as defined by each Party's standards, for final trunk groups between a MCI end office and a Sprint access tandem carrying meet point traffic shall be maintained. All other final trunk groups are to be engineered with a blocking standard of one percent (1%). Direct end office trunk groups are to be engineered with a blocking standard of one percent (1%).

## **4.3 Trunk Servicing**

**4.3.1** Orders between the Parties to establish, add, change or disconnect trunks shall be processed by use of an ASR, or another industry standard eventually adopted to replace the ASR for local service ordering.

**4.3.2** As discussed in this Agreement, both Parties will jointly manage the capacity of local interconnection trunk groups. Sprint's trunk servicing group will send a trunk group service request ("TGSR") to MCI to trigger changes Sprint desires to the local interconnection trunk groups based on Sprint's capacity assessment. MCI will issue an ASR to Sprint:

**4.3.2.1** Within ten (10) business days after receipt of the TGSR upon review of and in response to Sprint's TGSR; or

**4.3.2.2** At any time as a result of MCI's own capacity management assessment, to begin the provisioning process.

**4.3.3** The standard interval used for the provisioning of local interconnection trunk groups shall be determined by subscriber desired due date, but in no event shall it be longer than ten (10) working days.

**4.3.4** Orders that comprise a major project that directly impacts the other Party may be submitted at the same time, and their implementation shall be jointly planned and coordinated. Major projects are those that require the coordination and execution of

multiple orders or related activities between and among Sprint and MCI work groups, including, but not limited to, the initial establishment of Local Interconnection or Meet Point trunk groups and service in an area, NXX Code moves, re-homes, facility grooming, or network rearrangements.

4.3.5 MCI and Sprint agree to exchange escalation lists which reflect contact personnel including vice president-level officers. These lists shall include name, department, title, phone number, and fax number for each person. MCI and Sprint agree to exchange an up-to-date list on a quarterly basis.

## **Section 5. Network Management**

### **5.1 Protective Protocols**

5.1.1 Either Party may use protective network traffic management controls such as seven (7) digit and ten (10) digit code gaps on traffic toward each other's network, when required to protect the public switched network from congestion due to facility failures, Switch congestion or failure or focused overload. MCI and Sprint will immediately notify each other of any protective control action planned or executed.

### **5.2 Expansive Protocols**

5.2.1 Where the capability exists, originating or terminating traffic reroutes may be implemented by either Party to temporarily relieve network congestion due to facility failures or abnormal calling patterns. Reroutes will not be used to circumvent normal trunk servicing. Expansive controls will only be used when mutually agreed to by the Parties.

### **5.3 Mass Calling**

5.3.1 MCI and Sprint shall cooperate and share pre-planning information, where available, regarding cross-network call-ins expected to generate large or focused temporary increases in call volumes, to prevent or mitigate the impact of these events on the public switched network.

## **Section 6. Busy Line Verify and Interrupt**

6.1 **Description.** Each Party shall establish procedures whereby its operator bureau will coordinate with the operator bureau of the other Party

in order to provide BLV/LI services on calls between their respective end users on or before the Effective Date of this Agreement.

**6.2 Compensation.** Each Party shall charge the other Party for BLV/LI at rates specified in Attachment I.

***Section 7. Usage Measurement***

7.1 Each Party shall calculate terminating interconnection minutes of use based on standard AMA recordings made within each Party's network, these recordings being necessary for each Party to generate bills to the other Party. In the event either Party cannot measure minutes terminating on its network, the other Party shall provide the measuring mechanism or the Parties shall otherwise agree on an alternate arrangement.

7.2 Measurement of minutes of use over local interconnection trunk groups shall be in actual conversation seconds. The total conversation seconds over each individual local interconnection trunk group will be totaled for the entire monthly bill-round and then rounded to the next whole minute.

7.3 Each Party shall provide to the other, within twenty (20) business days after the end of each quarter (commencing with the first full quarter after the Effective Date of this Agreement), a usage report with the following information regarding traffic sent by the recording Party over the Local Interconnection trunk groups, whether the arrangement is direct interconnection or transit through a third party:

7.3.1 Total traffic volume described in terms of minutes and messages and by call type (local, toll, and other) terminated to each other over the local interconnection trunk groups; and

7.3.2 Percent Local Use ("PLU").

***Section 8. Responsibilities of the Parties***

8.1 Sprint and MCIIm agree to treat each other fairly, nondiscriminatorily, and equally for all items included in this Agreement, or related to the support of items included in this Agreement.

8.2 MCIIm and Sprint agree to exchange such reports and/or data as provided in this Attachment in Section 7 to facilitate the proper billing of traffic. Either Party may request an audit of such usage reports on no fewer than ten (10) business days' written notice and any audit shall be accomplished during normal business hours at the office of the Party

being audited. Such audit must be performed by a mutually agreed-to independent auditor paid for by the Party requesting the audit and may include review of the data described in Section 7 above. Such audits shall be requested within six (6) months of having received the PLU factor and usage reports from the other Party. Any adjustments, credits, or payments, and any corrective action that is determined to be necessary, as a result of this audit shall be made or taken in accordance with the procedures set forth in Section 22.4 of Part A of this Agreement.

8.3 MCI and Sprint will review engineering requirements on a semi-annual basis and establish forecasts for trunk and facilities utilization provided under this Agreement. Sprint and MCI will work together to begin providing these forecasts within thirty (30) days from the Effective Date of this Agreement. New trunk groups will be implemented as dictated by engineering requirements for either Sprint or MCI.

8.4 MCI and Sprint shall share responsibility for all Control Office functions for local interconnection trunks and trunk Groups, and both Parties shall share the overall coordination, installation, and maintenance responsibilities for these trunks and trunk groups.

8.5 MCI is responsible for all Control Office functions for the meet point trunking arrangement trunks and trunk groups, and shall be responsible for the overall coordination, installation, and maintenance responsibilities for these trunks and trunk groups.

8.6 MCI and Sprint shall:

8.6.1 Provide trained personnel with adequate and compatible test equipment to work with each other's technicians;

8.6.2 Notify each other when there is any change affecting the service requested, including the due date;

8.6.3 Coordinate and schedule testing activities of their own personnel, and others as applicable, to ensure their interconnection trunks/trunk groups are installed per the interconnection order, meet agreed-upon acceptance test requirements, and are placed in service by the due date;

8.6.4 Perform sectionalization to determine if a trouble is located in its facility or its portion of the interconnection trunks prior to referring the trouble to each other;

8.6.5 Advise each other's Control Office if there is an equipment failure which may affect the interconnection trunks;

8.6.6 Provide each other with a trouble reporting/repair contact number that is readily accessible and available twenty-four (24) hours per day/seven (7) days a week. Any changes to this contact arrangement must be immediately provided to the other Party;

8.6.7 Provide to each other test line numbers and access to test lines; and

8.6.8 Cooperatively plan and implement coordinated repair procedures for the meet point and local interconnection trunks and facilities to ensure trouble reports are resolved in a timely and appropriate manner.

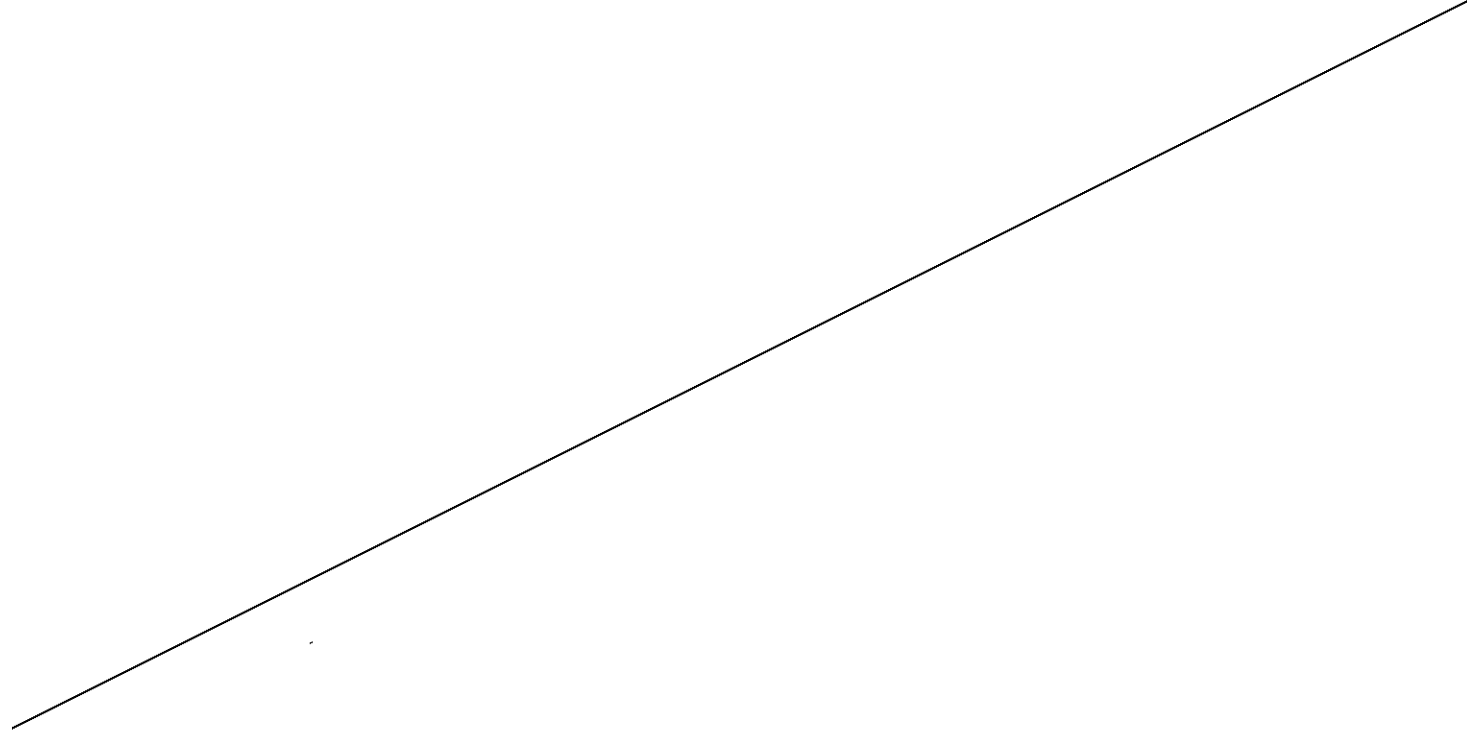

**TABLE OF CONTENTS**

**Attachment V  
COLLOCATION**

Section 1.	Introduction	V-1
Section 2.	Technical Requirements	V-1
Section 3.	Physical Security	V-19
Section 4.	License	V-22
Section 5.	Technical References	V-22

## **ATTACHMENT V**

### **COLLOCATION**

#### ***Section 1. Introduction***

This Attachment sets forth the requirements for Collocation.

#### ***Section 2. Technical Requirements***

2.1 Sprint shall provide space, as requested by MCI, to meet MCI's needs for placement of equipment, interconnection, or provision of service ("Collocated Space").

2.1.1 MCI shall not occupy or use the Collocated Space, or permit the Collocated Space to be occupied or used, for any purpose, act or thing, whether or not otherwise permitted by this Agreement, if such purpose, act or thing: (i) is in violation of any public law, ordinance or governmental regulation; (ii) may be dangerous to persons or property; (iii) may invalidate or increase the amount of the premiums beyond such increase as results from the contemplated occupancy in this Agreement for any insurance policy carried on the building or covering its operations; or (iv) violates the terms of this Agreement.

2.2 Sprint shall offer intraoffice facilities (e.g., DS0, DS-1, DS-3, and other available transmission speeds where available) to meet MCI's need for placement of equipment, interconnection, or provision of service.

2.3 Sprint agrees to allow MCI's employees and designated agents unrestricted but escorted access to MCI dedicated space in manned Sprint offices twenty-four (24) hours per day each day of the week. MCI shall use reasonable efforts to provide Sprint twenty-four (24) hours prior notice of such access. Sprint may place reasonable security restrictions, including an escort requirement, on access by MCI's employees and designated agents to the Collocated Space in unmanned Sprint offices. Notwithstanding the above, Sprint agrees that such space shall be available to MCI's employees and designated agents twenty-four (24) hours per day each day of the week upon twenty-four (24) hour prior notice. In no case should any reasonable security restrictions be more



restrictive than those Sprint places on their own personnel, except with respect to an escort requirement as set forth above.

2.4 MCIIm may collocate the amount and type of equipment it deems necessary in its Collocated Space in accordance with FCC Rules and Regulations, except for switching equipment which will not be collocated. Such equipment shall meet Bellcore specifications and be manufactured by a Sprint approved vendor. Approved vendors will, at a minimum, be vendors Sprint currently approves for their own use. Sprint will approve additional vendors provided they meet Bellcore standards.

2.5 Sprint shall permit a collocating Telecommunications carrier to interconnect its network with that of another collocating Telecommunications carrier at the Sprint premises and to connect its collocated equipment to the collocated equipment of another Telecommunications carrier within the same premises. Sprint in all cases shall provide such interconnections.

2.6 Sprint shall permit MCIIm or its designated subcontractor to perform the construction of physical Collocation arrangements, provided, however, that any such MCIIm subcontractor shall be subject to Sprint's approval, such approval shall not be unreasonably withheld. Approval by Sprint shall be based on the same criteria it uses in approving contractors for its own purposes.

2.7 MCIIm shall not make substantial installations, alterations or additions in or to the Collocated Space without submitting plans and specifications to Sprint and securing the prior written consent of Sprint in each instance. Sprint's consent shall not be unreasonably withheld or unduly delayed for non-structural interior alteration to the Collocated Space that do not adversely affect the building's appearance, value, structural strength and mechanical integrity. Such work shall be done at the sole expense of MCIIm.

2.7.1 All installations, alterations and additions shall be constructed in a good and workmanlike manner and only new and good grades of material shall be used, and shall comply with all insurance requirements, governmental requirements, and terms of this Agreement. Work shall be performed at such times and in such manner as to cause a minimum of interference with Sprint's transaction of business. MCIIm shall permit Sprint to inspect all construction operations within the premises and to approve contractors, which approval shall not be unreasonably withheld. If alterations are made by MCIIm's contractors, MCIIm shall furnish to Sprint prior to commencement thereof, building permits and

certificates of insurance to be provided by MCI's contractors and sub-contractors. Any such insurance to be provided by MCI's contractors or sub-contractors shall provide for coverage in amounts not less than as required by Sprint of MCI under Subsection 2.45 of this Attachment V. Upon completion of any installation, alteration or addition, contractor's affidavits and full and final waivers of lien covering all labor and material expended and used shall be furnished to Sprint. MCI and its contractors and sub-contractors shall hold Sprint harmless from all claims, costs, damages, liens and expenses which may arise out of or be connected in any way with installations, alterations or additions.

**2.7.2 All installations, alterations and additions which take the form of fixtures, except trade fixtures, placed in the Collocated Space by and at the expense of MCI or others shall become the property of Sprint, and shall remain upon and be surrendered with the Collocated Space. Upon termination of a license for Collocated Space; however, Sprint shall have the right to require MCI to remove such fixtures and installations, alterations or additions at MCI's expense, and to surrender the Collocated Space in the same condition as it was prior to the making of any or all such improvements, reasonable wear and tear excepted.**

**2.7.3 All fixtures and other equipment to be used by MCI in, about or upon the premises shall be subject to the prior written approval of Sprint, which shall not be unreasonably withheld.**

**2.8 Sprint shall provide basic telephone service with a connection jack as ordered by MCI from Sprint for the Collocated Space. Upon MCI's request, this service shall be available at the Collocated Space on the day that the space is turned over to MCI by Sprint.**

**2.9 Sprint shall provide adequate lighting, ventilation, power, heat, air conditioning, and other environmental conditions for MCI's space and equipment. These environmental conditions shall adhere to Bell Communication Research ("Bellcore") Network Equipment Building System ("NEBS") standards TR-EOP-000063 or other mutually agreed standards.**

**2.9.1 If MCI locates equipment or facilities in the Collocated Space which Sprint determines affect the temperature or other environmental conditions otherwise maintained by Sprint in the building, Sprint reserves the right to provide and install supplementary air conditioning units or other environmental control devices for the Collocated Space, and the cost of providing.**

installing, operating and maintaining any such supplementary air conditioning units or other environmental control devices made necessary solely by MCI's equipment or facilities shall be paid by MCI to Sprint.

2.9.2 If MCI's equipment or facilities requires cooling capability in excess of that normally provided by Sprint for its own equipment, any required supplementary air conditioning required by MCI shall be paid by MCI to Sprint.

2.10 Where available and subject to Sprint's standard security procedures, Sprint shall provide access to eyewash stations, shower stations, bathrooms, and drinking water within the collocated facility on a twenty-four (24) hours per day, seven (7) days per week basis for MCI personnel and its designated agents.

2.11 Sprint shall provide all ingress and egress of fiber and power cabling to Collocated Spaces. MCI's specific diversity requirements for each site or Network Element will be provided in the Collocation request.

2.12 Each Party shall ensure protection of the other Party's proprietary subscriber information. In conjunction with any Collocation arrangement Sprint and MCI shall adhere to the provisions of Section 21 of Part A of this Agreement.

2.13 Sprint shall participate in and adhere to negotiated and agreed to service guarantees and Performance Standards, if any.

2.14 Sprint shall provide MCI with written notice five (5) business days prior to those instances where Sprint or its subcontractors may be performing work in the general area of the Collocated Space, or in the general area of the AC and DC power plants which support MCI equipment. Sprint will inform MCI by telephone of any emergency-related activity that Sprint or its subcontractors may be performing in the general area of the Collocated Space, or in the general area of the AC and DC power plants which support MCI equipment. Notification of any emergency-related activity shall be made immediately prior to the start of the activity so that MCI can take any action required to monitor or protect its service.

2.15 Sprint shall, at its sole expense, except as hereinafter provided, provide repair and maintenance of heating, cooling and lighting equipment and regularly scheduled refurbishments or decorating to the Collocated Space, building and property, in a manner consistent with Sprint's normal business practices.

2.15.1 Sprint shall, where practical, provide MCIIm with twenty-four (24) hours prior notice before making repairs and/or performing maintenance on the Collocated Space; provided, however, that Sprint shall have no obligation to provide such notice if Sprint determines, in the exercise of its sole discretion, that such repair or maintenance must be done sooner in order to preserve the safety of the building or the Collocated Space, or if required to do so by any court or governmental authority. Work shall be completed during normal working hours or at other times identified by Sprint; provided, however, that MCIIm shall pay Sprint for overtime and for any other expenses incurred if such work is done during other than normal working hours at MCIIm's request. MCIIm shall have the right, at its sole expense, to be present during repair or maintenance of the Collocated Space.

2.16 MCIIm shall provide Sprint with written notice five (5) business days prior to those instances where MCIIm or its subcontractors may be performing work in the general area of the Collocated Space, or in the general area of the AC and DC power plants which support Sprint equipment. MCIIm will inform Sprint by telephone of any emergency-related activity that MCIIm or its subcontractors may be performing in the general area of the Collocated Space, or in the general area of the AC and DC power plants which support Sprint equipment. Notification of any emergency-related activity shall be made immediately prior to the start of the activity so that Sprint can take any action required to monitor or protect its service.

2.17 To the extent Sprint performs the construction of the physical Collocation arrangement, Sprint shall construct the Collocated Space in compliance with mutually agreed Collocation request. Any deviation from MCIIm's order must thereafter be approved by MCIIm.

2.18 MCIIm and Sprint will complete an acceptance walk through of those portions of the Collocation arrangement provided by Sprint. Exceptions that are noted during this acceptance walk through shall be corrected by Sprint within five (5) business days after the walk through except where circumstances reasonably warrant additional time. In such event subject to MCIIm's consent, which shall not be unreasonably withheld, Sprint shall be given additional time. The correction of these exceptions from the original Collocation request shall be at Sprint's expense.

2.19 Sprint shall provide detailed Telephone Equipment drawings depicting the exact location, type, and cable termination requirements (*i.e.*, connector type, number and type of pairs, and naming convention)

for Sprint Point of Termination Bay(s) to MCI within ten (10) business days of acceptance of MCI's request for Collocated Space.

2.20 Sprint shall provide detailed drawings depicting the exact path, with dimensions, for MCI Outside Plant Fiber ingress and egress into Collocated Space within ten (10) business days of the acceptance of MCI's request for Collocated Space.

2.21 Sprint shall provide detailed power cabling connectivity information including the sizes and number of power feeders to MCI within ten (10) business days of the acceptance of MCI's request for Collocated Space.

2.22 To the extent Sprint performs the construction of the physical Collocation arrangement, Sprint shall provide positive confirmation to MCI when construction of Collocated Space is fifty percent (50%) completed. This confirmation shall also include confirmation of the scheduled completion and turnover dates.

2.23 Sprint shall provide the following information to MCI within ten (10) business days of receipt of a written request from MCI:

2.23.1 Work restriction guidelines;

2.23.2 Sprint or industry technical publication guidelines that impact the design of Sprint collocated equipment;

2.23.3 Sprint contacts (names and telephone numbers) for the following areas:

- Engineering
- Physical & Logical Security
- Provisioning
- Billing (Related to Collocation Services)
- Operations
- Site and Building Managers
- Environmental and Safety; and

2.23.4 Escalation process for the Sprint employees (names, telephone numbers and the escalation order) for any disputes or problems that might arise pursuant to MCI's Collocation.

2.24 Power as referenced in this document refers to any electrical power source supplied by Sprint for MCI equipment. It includes all superstructure, infrastructure, and overhead facilities, including, but not limited to, cable, cable racks and bus bars. Sprint will supply power to

support MCIIm equipment at equipment specific DC and AC voltages. At a minimum, Sprint shall supply power to MCIIm at Parity with that provided by Sprint to itself or to any third party. If Sprint performance, availability, or restoration falls below industry standards, Sprint shall bring itself into compliance with such industry standards as soon as technologically feasible.

2.24.1 Central office power supplied by Sprint into the MCIIm equipment area, shall be supplied in the form of power feeders (cables) on cable racking into the designated MCIIm equipment area. The power feeders (cables) shall efficiently and economically support the requested quantity and capacity of MCIIm equipment. The termination location shall be as requested by MCIIm.

2.24.2 Sprint shall provide power as requested by MCIIm to meet MCIIm's need for placement of equipment, interconnection, or provision of service.

2.24.3 Sprint power equipment supporting MCIIm's equipment shall:

2.24.3.1 Comply with applicable industry standards (e.g., Bellcore, NEBS and IEEE) or manufacturer's equipment power requirement specifications for equipment installation, cabling practices, and physical equipment layout or at minimum, at Parity with that provided for similar Sprint equipment;

2.24.3.2 Have redundant power feeds with physical diversity and battery back-up as required by the equipment manufacturer's specifications for MCIIm equipment, or, at a minimum, at Parity with that provided for similar Sprint equipment;

2.24.3.3 Provide, upon MCIIm's request, the capability for Real Time access to power performance monitoring and alarm data that impacts (or potentially may impact) MCIIm traffic;

2.24.3.4 Provide central office ground, connected to a ground electrode located within the Collocated Space, at a level above the top of MCIIm equipment plus or minus two (2) feet to the left or right of MCIIm's final request; and

**2.24.3.5 Provide feeder cable capacity and quantity to support the ultimate equipment layout for MCIIm equipment in accordance with MCIIm's Collocation request.**

**2.24.3.6 To the extent Sprint performs the construction of physical Collocation arrangements, Sprint shall, within ten (10) business days of MCIIm's request:**

**2.24.3.6.1 Provide prices for Collocation as set forth in Sprint's tariffs (non-tariffed charges shall be negotiated between the Parties);**

**2.24.3.6.2 Provide an installation schedule and access that will allow Sprint and MCIIm installation efforts in parallel without jeopardizing either Party's personnel safety or existing services; and**

**2.24.3.6.3 Provide information on existing power plant alarms that adhere to Bell Communication Research ("Bellcore") Network Equipment Building System ("NEBS") standards TR-EOP-000063;**

**2.24.3.7 Sprint shall provide cabling that adheres to Bell Communication Research ("Bellcore") Network Equipment Building System ("NEBS") standards TR-EOP-000063;**

**2.24.3.8 Sprint shall provide Lock Out-Tag Out and other electrical safety procedures and devices in conformance with the most stringent of OSHA or industry guidelines.**

**2.24.4 Sprint will provide MCIIm with written notification within ten (10) business days of any scheduled AC or DC power work or related activity in the collocated facility that will or might cause an outage or any type of power disruption to MCIIm equipment located in Sprint's facility. Sprint shall provide MCIIm immediate notification by telephone of any emergency power activity that would impact MCIIm equipment.**

**2.24.5 MCIIm will provide Sprint with written notification within ten (10) business days of any scheduled AC or DC power work or related activity in the collocated facility that will or might cause an outage or any type of power disruption to Sprint equipment located in MCIIm facility. MCIIm shall provide Sprint immediate notification by telephone of any emergency power activity that would impact Sprint equipment.**

2.25 To the extent that space for virtual Collocation is available, Sprint shall provide virtual Collocation where physical Collocation is not practical for technical reasons or because of space limitations. Sprint shall take collocator demand into account when renovating existing facilities and constructing or leasing new facilities. Space for physical or virtual Collocation will be made available to MCIIm consistent with the requirements of the Act.

2.26 Where Collocation space and associated requirements are available, intervals for physical Collocation shall be a maximum of three (3) months from the requested date, subject to additional time for asbestos removal or extraordinary construction as mutually agreed upon by MCIIm and Sprint. Virtual Collocations will have a maximum interval of two (2) months.

2.27 MCIIm may choose to lease unbundled transport from the Sprint facility, or from a third carrier, rather than construct to the Sprint facility where equipment will be collocated.

2.28 Sprint will maintain, at MCIIm's expense, MCIIm's virtually collocated equipment in a manner equal to, or better than, how it maintains its own equipment. Maintenance includes the change out of electronic cards provided by MCIIm and per MCIIm's request.

2.29 As part of the license granted in Section 4 herein, MCIIm, its employees, agents and invitees shall have a non-exclusive right to use those portions of the common area of the building as are designated by Sprint from time to time, including, but not limited to, the right to use rest rooms in proximity to the Collocated Space, corridors and other access ways from the entrance to the building, the Collocated Space, and the parking areas adjacent to the building for vehicles of persons while working for or on behalf of MCIIm at the Collocated Space; provided, however, that Sprint shall have the right to reserve parking spaces for Sprint's exclusive use or by other occupants of the building. Sprint does not guarantee that there is or will be sufficient parking spaces in parking areas to meet MCIIm's needs. All common areas shall remain under the exclusive control and management of Sprint, and Sprint shall have the right to change the level, location and arrangement of parking areas and other common areas as Sprint may deem necessary. Use of all common areas shall be subject to such reasonable rules and regulations as Sprint may from time to time impose, such as those set forth in Section 2.3 of this Attachment V.

2.30 Where available, Sprint shall furnish passenger elevator service as necessary to reach the Collocated Space or common areas to which



MCIIm has access pursuant to the terms of this Attachment V twenty-four (24) hours a day, seven (7) days a week. Where available, freight elevator service when used by MCIIm's contractors, employees or agents shall be provided at times reasonably satisfactory to Sprint.

2.31 MCIIm shall regularly inspect the Collocated Space to ensure that the Collocated Space is in good working condition. MCIIm shall promptly notify Sprint of any damage to the Collocated Space or of the need to perform any repair or maintenance of the Collocated Space, fixtures and appurtenances (including hardware, heating, cooling, ventilating, electrical and other mechanical facilities in the Collocated Space). MCIIm shall keep the Collocated Space clean and trash free.

2.31.1 The cost of all repairs and maintenance performed by or on behalf of Sprint to the Collocation Space or building which are, in Sprint's reasonable judgment, beyond normal repair and maintenance, or are made necessary as a result of misuse or neglect by MCIIm or MCIIm's employees, invitees, or agents, shall be paid by MCIIm, pursuant to Attachment VIII, Section 3.

2.32 MCIIm shall, with the prior written consent of Sprint, have the right to provide additional fire protection systems within the Collocated Space; provided, however, that MCIIm may not install or use sprinklers or carbon dioxide fire suppression systems within the building or the Collocated Space. If any governmental bureau, department or organization or Sprint's insurance carrier requires that changes, modifications, or alterations be made to the fire protection system, or that additional stand alone fire extinguishing, detection or protection devices be supplied within the Collocated Space, such changes, modifications or additions shall be made by MCIIm at its expense, following review and approval by Sprint prior to any work being done. If any governmental bureau, department or organization or Sprint's insurance carrier requires that changes or modifications be made to the fire protection system or that additional stand alone fire extinguishing, detection or protection devices be supplied within that portion of the building in which the Collocated Space of MCIIm's in general are located, such changes, modifications, or additions shall be made by Sprint and MCIIm shall reimburse Sprint for the cost thereof in the same proportion as the square footage of the Collocated Space as compared to the total square footage of the affected portion of the building.

2.33 MCIIm, its employees, agents, contractors, and business invitees shall: (i) comply with all rules and regulations which Sprint may from time to time adopt for the safety, environmental protection, care, cleanliness and/or preservation of the good order of the building, the property and the

Collocated Space and its tenants and occupants; and (ii) comply, at its own expense, with all ordinances which are applicable to the Collocated Space and with all lawful orders and requirements of any regulatory or law enforcement agency requiring the correction, prevention and abatement of nuisances in or upon the Collocated Space during the term of this Agreement or any extension hereof.

2.34 MCIIm shall not cut or drill into, drive nails or screws into, install Conduit or wires, or in any way deface any part of the Collocated Space or the building, outside or inside, without the prior written consent of Sprint. If MCIIm desires signal, communications, alarm or other utility or service connections installed or changed, the same shall be made by and at the expense of MCIIm. Sprint shall have the right of prior approval of such utility or service connections, and shall direct where and how all connections and wiring for such service shall be introduced and run. In all cases, in order to maintain the integrity of the halon space for proper halon concentration, and to ensure compliance with Sprint's fireproofing policy, any penetrations by MCIIm, whether in the Collocated Space, the building or otherwise, shall be sealed as quickly as possible by MCIIm with Sprint-approved fire barrier sealants, or by Sprint at MCIIm's cost.

2.35 MCIIm shall not exceed the uniformly distributed live load capacity.

2.36 MCIIm equipment within the Collocated Space shall be connected to Sprint's grounding system.

2.37 MCIIm shall post in a prominent location visible from the common building area, the telephone numbers of emergency contact personnel for twenty-four (24) hour emergency use by Sprint. MCIIm will promptly update this information as changes occur.

2.38 MCIIm shall not paint, display, inscribe or affix any sign, trademark, picture, advertising, notice, lettering or direction on any part of the outside or inside of the Sprint location, or on the Collocated Space, without the prior written consent of Sprint.

2.39 MCIIm shall not use the name of the Sprint building or Sprint for any purpose other than that of the business address of MCIIm, or use any picture or likeness of the Sprint building on any letterhead, envelope, circular, notice or advertisement, without the prior written consent of Sprint.

2.40 MCIIm shall not exhibit, sell or offer for sale, rent or exchange in the Collocated Space or on the Sprint property any article, thing or service



except those ordinarily embraced within the use of the Collocated Space specified in this Attachment V, without the prior written consent of Sprint.

2.41 MCI shall not place anything or allow anything to be placed near the glass of any door, partition or window which Sprint determines is unsightly from outside the Collocated Space; take or permit to be taken in or out of other entrances of the Sprint building, or take or permit to be taken on any passenger elevators, any item normally taken through service entrances or elevators; or whether temporarily, or accidentally, or otherwise, allow anything to remain in, place, or store anything in, or obstruct in any way, any passageway, exit, stairway, elevator, or shipping platform. MCI shall lend its full cooperation to keep such areas free from all obstruction and in a clean and slightly condition, move all supplies, furniture and equipment directly to the Collocated Space as soon as received, and move all such items and waste, other than waste customarily removed by employees of the building.

2.42 MCI shall not do or permit anything to be done upon the premises, or bring or keep anything thereon which is in violation of any federal, state or local laws or regulations (including environmental laws or regulations not previously described), or any rules, regulations or requirements of the local fire department, Fire Insurance Rating Organization, or any other similar authority having jurisdiction over the building. MCI shall not do or permit anything to be done upon the premises which may in any way create a nuisance, disturb, endanger, or otherwise interfere with the Telecommunications Services of Sprint, any other occupant of the building, their patrons or customers, or the occupants of neighboring property, or injure the reputation of the property.

2.42.1 MCI shall not, without the prior written consent of Sprint: (i) install or operate any lead-acid batteries, refrigerating, heating or air conditioning apparatus or carry on any mechanical business in the premises; (ii) use the premises for housing, lodging, or sleeping purposes; (iii) permit preparation or warming of food, presence of cooking or vending equipment, sale of food or smoking in the premises; or (iv) permit the use of any fermented, intoxicating or alcoholic liquors or substances in the premises or permit the presence of any animals except those used by the visually impaired. Sprint may, in its sole discretion, withhold such consent, or impose any condition in granting it, and revoke its consent at will.

2.43 Sprint reserves the right to stop any service when Sprint deems such stoppage necessary by reason of accident or emergency, or for repairs, improvements or otherwise; however, Sprint agrees to use its

best efforts not to interfere with MCI's use of the Collocation Space. Sprint does not warrant that any service will be free from interruptions caused by labor controversies, accidents, inability to obtain fuel, water or supplies, governmental regulations, or other causes beyond the reasonable control of Sprint.

2.43.1 No such interruption of service shall be deemed an eviction or disturbance of MCI's use of the Collocation Space or any part thereof, or render Sprint liable to MCI for damages, by abatement of Collocation charges, except as set forth in the tariff, or relieve MCI from performance of its obligations under this Agreement. MCI hereby waives and releases all other claims against Sprint for damages for interruption or stoppage of service.

2.43.2 Sprint shall have the right to reduce heat, light, water and power as required by any mandatory or voluntary conservation programs, in a manner consistent with the conditions maintained by Sprint for its own use.

2.44 Sprint shall have the following rights, and others not specifically excluded in this Agreement, exercisable without notice and without liability to MCI for damage or injury to property, person or business (all claims for damage being hereby released), and without effecting an eviction or disturbance of MCI's use or possession or giving rise to any claim for offsets, or abatement of rent:

2.44.1 To change the name or street address of the building;

2.44.2 To install and maintain signs on the exterior and interior of the building or anywhere on the property;

2.44.3 To designate all sources furnishing sign painting and lettering, ice, mineral or drinking water, beverages, foods, towels, vending machines or toilet supplies used or consumed in the premises;

2.44.4 To use any means Sprint may deem proper to open Collocation Space doors in an emergency. Entry into the Collocation Space obtained by Sprint by any such means shall not be deemed to be forcible or unlawful entry into or a detainment of or an eviction of MCI from the Collocation Space or any portion thereof;

2.44.5 To utilize the space within the building in such a manner as will best enable it to fulfill its own service requirements;

2.44.6 At any time, to decorate and to make, at its own expense, repairs, alterations, additions, and improvements, structural or otherwise, in or to the premises, the property, or any part thereof (including, without limitation, the permanent or temporary relocation of any existing facilities such as parking lots or spaces), and to perform any acts related to the safety, protection or preservation thereof, and during such operations to take into and through the premises or any part of the property all material and equipment required, and to close or suspend temporarily operation of entrances, doors, corridors, elevators or other facilities, provided that Sprint shall limit inconvenience or annoyance to MCI<sub>m</sub> as reasonably possible under the circumstances;

2.44.7 To do or permit to be done any work in or about the Collocation Space or the property or any adjacent or nearby building, land, street or alley;

2.44.8 To grant to anyone the exclusive right to conduct any business or render any service on the property, provided such exclusive right shall not operate to exclude MCI<sub>m</sub> from the use expressly permitted by this Agreement;

2.44.9 If it becomes necessary in Sprint's reasonable judgment, and there are no other reasonable alternatives, to require MCI<sub>m</sub> to move to equivalent Collocation Space in the building upon receipt of sixty (60) days written notice from Sprint, in which event, Sprint shall pay all moving costs, and the charges for Collocation provided for herein shall remain the same; and

2.44.10 To designate all spaces occupied by MCI<sub>m</sub>'s facilities under this Agreement.

2.45 MCI<sub>m</sub> shall carry insurance, at MCI<sub>m</sub>'s expense, insuring MCI<sub>m</sub> and, except for worker's compensation, and showing Sprint as additional insured and/or loss payee, as its interest may appear. Such insurance shall contain such terms and conditions and provide such coverages and exclusions, as commercially reasonable under the circumstances as determined by MCI<sub>m</sub>.

2.45.1 As of the date that MCI<sub>m</sub> begins construction of any portion of a physical Collocation arrangement or as of the date that MCI<sub>m</sub> begins to occupy any physical Collocation arrangement under this Agreement, whichever is earlier, MCI<sub>m</sub> shall maintain the following coverages in the following amounts:

2.45.1.1 Commercial general liability, occurrence from, in limits of not less than one million dollars (\$1,000,000) combined single limit for bodily injury, personal injury and property damage liability insurance to include coverage for products/completed operations and explosion, collapse and underground liability;

2.45.1.2 "All Risk" property insurance on a full replacement cost basis, insuring MCI's real and personal property situated on or within the property. MCI may elect to insure business interruption and contingent business interruption, as it is agreed that Sprint has no liability for loss of profit or revenues should an interruption of service occur;

2.45.1.3 Business auto insurance, including all owned, non-owned and hired automobiles, in an amount of not less than one million dollars (\$1,000,000) combined single limit for bodily injury and property damage liability;

2.45.1.4 Worker's compensation insurance in accordance with statutory requirements, and employer's liability with a minimum amount of five hundred thousand dollars (\$500,000) per accident; and

2.45.1.5 Umbrella or excess liability in an amount not less than five million dollars (\$5,000,000) per occurrence and aggregate to provide excess limits over all primary liability coverages.

2.45.2 The limits of the insurance policies obtained by MCI as required above shall in no way limit MCI's liability to Sprint should MCI be liable to Sprint under the terms of this Agreement or otherwise.

2.45.2.1 If MCI may self-insure all or part of the above requirements, then disclosure of limits and coverages self-insured is made to Sprint in writing. Upon such disclosure, MCI agrees that nothing diminishes MCI's responsibilities to Sprint that would have otherwise been covered by the required insurance. All changes to this self-insurance disclosure must also be made to Sprint in writing thirty (30) days in advance of the change.

2.45.3 MCI shall furnish to Sprint a certificate or certificates of insurance, satisfactory in form and content to Sprint, evidencing

that the above coverage is in force and has been endorsed. Such coverage will not be canceled or non-renewed without MCI first giving thirty (30) days prior written notice to Sprint (or if thirty (30) days' notice is not practicable under the circumstances, such shorter notice period as may be practicable).

2.45.4 All policies required of MCI shall contain evidence of the insurers waiver of the right of subrogation against Sprint for any insured loss covered thereunder. All policies required of Sprint shall contain evidence of the insurers waiver of the right of subrogation against MCI for any insured loss covered thereunder. All policies of insurance shall be written as primary policies and not contributing with or in excess of the coverage, if any, that Sprint may carry.

2.46 If the premises or a portion thereof sufficient to make the premises substantially unusable shall be destroyed or rendered unoccupiable by fire or other casualty, Sprint may, at its option, restore the premises to its previous condition. A license granted under this Attachment shall not terminate unless, within ninety (90) days after the occurrence of such casualty, Sprint notifies MCI of its election to terminate said license. If Sprint does not elect to terminate said license, Sprint shall repair the damage to the premises caused by such casualty.

2.46.1 Notwithstanding any other contrary provision of this Agreement, if any casualty is the result of any act, omission or negligence of MCI, its agents, employees, contractors, licensees, customers or business invitees, unless Sprint otherwise elects, a license for Collocation Space shall not terminate, and, if Sprint elects to make such repairs, MCI shall reimburse Sprint for the cost of such repairs, or MCI shall repair such damage, including damage to the building and the area surrounding it, and the charges to be paid to Sprint by MCI shall not abate.

2.46.2 If the building shall be damaged by fire or other casualty to the extent that portions are rendered unoccupiable, notwithstanding that the Collocation Space may be directly unaffected, Sprint may, at its election within ninety (90) days of such casualty, terminate a license for Collocation Space by giving written notice of its intent to terminate said license. The termination as provided in this Subsection shall be effective thirty (30) days after the date of the notice.



2.46.3 Notwithstanding any other provision of this Agreement, Sprint shall not be liable for any repair or restoration until, and then only to the extent that, insurance proceeds are received.

2.47 If the property, or any portion thereof which includes a substantial part of the Collocation Space, shall be taken or condemned by any competent authority for any public use or purpose, the term of a Collocation Space license shall end upon, and not before, the date when the possession of the part so taken shall be required for such use or purpose. If any condemnation proceeding shall be instituted in which it is sought to take or damage any part of the property, or if the grade of any street or alley adjacent to the property is changed by any competent authority and such change of grade makes it necessary or desirable to remodel the property to conform to the changed grade, Sprint shall have the right to terminate a Collocation Space license upon not less than 30 days' notice prior to the date of cancellation designated in the notice. Sprint shall notify MCIIm of any such taking, change of grade, or other proceeding or action described in this section promptly upon Sprint's receiving notice thereof. Sprint will also give MCIIm prompt notice of Sprint's intentions with regard to relocating Sprint's affected equipment, facilities, or functions and the Parties will use commercially reasonable efforts to cooperate to identify alternate Collocation Space, if available, for MCIIm's affected equipment, facilities or functions within the Sprint network. No money or other consideration shall be payable by Sprint to MCIIm for such cancellation, and MCIIm shall have no right to share any condemnation award to Sprint or in any judgment for damages to Sprint caused by such eminent domain proceedings.

2.48 At the termination of a Collocation Space license by lapse of time or otherwise:

2.48.1 MCIIm shall surrender all keys, access cards and Sprint-provided photo identification cards to the Collocation Space and the building to Sprint, and shall make known to Sprint the combination of all combination locks remaining on the Collocation Space.

2.48.2 MCIIm shall remove its equipment from the Collocation Space within thirty (30) days.

2.48.3 MCIIm shall return to Sprint the Collocation Space and all equipment and fixtures of Sprint in as good a condition and state of repair as when MCIIm originally took possession, normal wear and tear or damage by fire or other casualty excepted. MCIIm shall be responsible to Sprint for the cost of any repairs that shall be made

necessary by the acts or omissions of MCIIm or of its agents, employees, contractors or business invitees. Sprint reserves the right to oversee MCIIm's withdrawal from the Collocation Space and MCIIm agrees to comply with all reasonable directives of Sprint regarding the removal of equipment and restoration of the Collocation Space, including, without limitation, Sprint's directive to return the Collocation Space in other than its original condition on the date of occupancy; provided, however, that MCIIm shall not be responsible for placing the Collocation Space in other than its original condition if to do so would put MCIIm to additional expense above and beyond that which would be necessary to return the Collocation Space in its original condition.

2.48.4 All installations, additions, hardware, non-trade fixtures and improvements, temporary or permanent, except movable furniture and equipment belonging to MCIIm, in or upon the Collocation Space, whether placed there by MCIIm or Sprint, shall be Sprint's property and shall remain upon or in the Collocation Space, all without compensation, allowance or credit to MCIIm; provided, however, that if prior to such termination or within ten (10) days thereafter, Sprint so directs, MCIIm shall promptly remove the installations, additions, hardware, non-trade fixtures and improvements, placed in or upon the Collocation Space by MCIIm, failing which Sprint may remove the same, and MCIIm shall, upon demand, pay to Sprint the cost of such removal and of any necessary restoration of the Collocation Space. No cable shall be removed from inner duct or outside cable duct except as directed by Sprint.

2.48.5 All fixtures, installations, and personal property belonging to Licensee not removed from the Collocation Space upon termination of a Collocation Space license and not required by Sprint, to have been removed as provided in this Attachment V, shall be conclusively presumed to have been abandoned by MCIIm and title thereto shall pass to Sprint under this Attachment V as if by a bill of sale.

2.48.6 If the Collocation Space is not surrendered at the termination of the Collocation Space license, MCIIm shall indemnify Sprint against loss or liability resulting from delay by MCIIm in so surrendering the Collocation Space, including, without limitation, any claims made by any succeeding tenant founded on such delay.

2.49 If the owner of the building or Sprint sells, transfers or assigns any interest in the building, or there is any material change in the lease to

which the building is subject, and such sale, transfer, assignment or material change in the lease gives rise to an obligation which is inconsistent with a Collocation Space license granted under this Attachment V, Sprint's performance under this Attachment V shall be excused to the extent of the inconsistency. Sprint hereby agrees that it will use its reasonable efforts to avoid any such inconsistency; provided, however, that this obligation shall in no way obligate Sprint to incur any out of pocket expenses in its efforts to avoid such inconsistencies.

2.50 A Collocation Space license granted under this Attachment V shall at all times be subject and subordinate to the lien of any mortgage (which term shall include all security instruments) that may be placed on the premises, building or any portion thereof and MCIIm agrees, upon demand, to execute any instrument as may be required to effectuate such subordination.

### ***Section 3. Physical Security***

3.1 Each Party shall exercise the same degree of care, but not less than reasonable to prevent harm or damage to the other Party or its employees, agents or subscribers, or their property. Sprint and its employees, agents or representatives shall take reasonable and prudent steps to ensure the adequate protection of MCIIm property, equipment and services including, but not limited to:

3.1.1 Restricting access to MCIIm equipment, support equipment, systems, tools, or spaces which contain or house MCIIm equipment enclosures to MCIIm employees and other authorized non-MCIIm personnel to the extent necessary to perform their specific job function.

3.1.2 MCIIm shall provide a written logbook for Sprint's employees to sign when entering MCIIm's physical Collocation Space which houses or contains MCIIm equipment or equipment enclosures.

3.1.3 When Sprint's employees enter MCIIm's physical Collocation Space, Sprint's employees shall comply at all times with MCIIm security and safety procedures and requirements, including but not limited to sign-in, identification, and escort requirements while in MCIIm's physical Collocation Spaces which house or contain MCIIm equipment or equipment enclosures and in compliance with MCIIm Physical Security Guidelines Manual, Dated November 1995. In the event any issues or problems arise under this Section 3.1, the Parties agree to negotiate a reasonable resolution to such issue or problem.

3.1.4 Ensuring that the physical Collocation area which houses MCI's equipment is adequately secured and monitored to prevent unauthorized entry to the same extent and at the same level Sprint provides itself.

3.1.5 Subject to Section 2.3 of this Attachment V, allowing MCI to inspect or observe spaces which house or contain MCI equipment or equipment enclosures at any time and to furnish MCI with all keys, entry codes, lock combinations, or other materials or information which may be needed to gain entry into any secured MCI space.

3.1.6 Limiting the keys used in its keying systems for MCI's physical Collocation Spaces which contains or houses MCI equipment or equipment enclosures to Sprint employees and representatives to emergency access only. MCI shall further have the right to change locks where deemed necessary for the protection and security of such spaces.

3.1.7 Upon MCI's request, installing security studs in the hinge plates of doors having exposed hinges with removable pins if such leads to MCI's physical Collocation Space which contains or houses MCI equipment or equipment enclosures.

3.1.8 Controlling unauthorized access from passenger and freight elevators by continuous surveillance or by personnel security escort, installing security partitions, security grills, locked gates or doors between elevator lobbies and spaces which contain or house MCI equipment or equipment enclosures.

3.1.9 Providing Real Time notification to designated MCI personnel to indicate an actual or attempted security breach.

3.1.10 Subject to the provisions of Sections 2.9, 2.9.1 and 2.9.2 above, ensuring that areas designated to house MCI equipment are environmentally appropriate for the MCI equipment installation, and adequate to maintain proper operating conditions for the MCI equipment.

3.2 Sprint, at MCI's expense, may issue non-employee photo identification cards for each MCI employee or vendor. Temporary identification cards may otherwise be provided by Sprint for employees or agents, contractors and invitees of MCI who may require occasional access to the Collocated Space.

3.3 Sprint may issue access cards, codes, or keys to MCI's listed employees or vendors where such systems are available and their use by MCI will not otherwise compromise building security.

3.4 Sprint reserves the right to close and keep locked all entrance and exit doors of the building during hours Sprint may deem advisable for the adequate protection of the building.

3.5 MCI agrees to abide by all of Sprint's security practices for non-Sprint employees with access to the building, including, without limitation:

3.5.1 MCI will supply to Sprint, and update as changes occur, a list of its employees or approved vendors who require access to the building. The list will include the social security numbers of all such individuals.

3.5.2 MCI is responsible for returning identification and access cards, codes, or keys of its terminated employees or its employees who no longer require access to the Collocated Space. All cards, codes, or keys must be returned upon termination of this Agreement. Unreturned or replacement cards, codes, or keys may be subject to a reasonable fee at the discretion of Sprint.

3.5.3 MCI's employees, agents, invitees and vendors must display identification cards at all times.

3.5.4 MCI will assist Sprint in validation and verification of identification of its employees, agents, invitees and vendors by providing a telephone contact available twenty-four (24) hours a day, seven (7) days a week to verify identification.

3.5.5 Before leaving the Collocated Space unattended, MCI shall close and securely lock all doors and windows and shut off unnecessary equipment in the Collocated Space. Any damage resulting from MCI's failure to do so shall be the responsibility of MCI.

3.6 MCI will allow Sprint to access its Collocated Space at all times, via pass key or otherwise, to allow Sprint to react to emergencies, to maintain the space (not including MCI equipment), and to monitor compliance with the rules and regulations of the Occupational Health and Safety Administration or Sprint, or other regulations and standards including but not limited to those related to fire, safety, health, and environmental safeguards. Except in emergencies or unless MCI has waived such notice elsewhere in this Attachment V, and if conditions permit, Sprint will

provide MCIIm with notice of its intent to access the Collocated Space, thereby providing MCIIm the option to be present at the time of access. MCIIm shall not attach, or permit to be attached, additional locks or similar devices to any door or window, nor change existing locks or the mechanism thereof.

**Section 4. License**

Sprint hereby grants MCIIm a license to occupy any premises or rack space which contain collocated equipment, including without limit all necessary ingress, egress and reasonable use of Sprint's property, for the Term of the Agreement.

**Section 5. Technical References**

Sprint shall provide Collocation in accordance with the following standards:

5.1 National Electrical Code ("NEC") use latest issue.

5.2 TA-NPL-000286, NEBS Generic Engineering Requirements for System Assembly and Cable Distribution, Issue 2 (Bellcore, January 1989).

5.3 TR-EOP-000063 Network Equipment Building System ("NEBS") Generic Equipment Requirements, Issue 3, March 1988.

5.4 TR-EOP-000151, Generic Requirements for 24-, 48-, 130-, and 140-Volt Central Office Power Plant Rectifiers, Issue 1 (Bellcore, May 1985).

5.5 TR-EOP-000232, Generic Requirements for Lead-Acid Storage Batteries, Issue 1 (Bellcore, June 1985).

5.6 TR-NWT-000154, Generic Requirements for 24-, 48-, 130, and 140-Volt Central Office Power Plant Control and Distribution Equipment, Issue 2 (Bellcore, January 1992).

5.7 TR-NWT-000295, Isolated Ground Planes: Definition and Application to Telephone Central Offices, Issue 2 (Bellcore, July 1992).

5.8 TR-NWT-000840, Supplier Support Generic Requirements ("SSGR"), (a Module of LSSGR, FR-NWT-000064), Issue 1 (Bellcore, December 1991).

5.9 TR-NWT-001275 Central Office Environment Installations/Removal Generic Requirements, Issue 1, January 1993.



**TABLE OF CONTENTS**

**Attachment VI  
RIGHTS OF WAY (ROW), CONDUIT, POLE ATTACHMENTS**

Section 1.	Introduction	VI-1
Section 2.	Definitions	VI-1
Section 3.	Requirements	VI-3



## ATTACHMENT VI

### RIGHTS OF WAY (ROW), CONDUIT, POLE ATTACHMENTS

#### **Section 1. Introduction**

This Attachment sets forth the requirements for Rights of Way, Conduits and Pole Attachments.

#### **Section 2. Definitions**

2.1 An "Anchor" refers to a device, structure, or assembly which stabilizes a Pole and holds it in place. An Anchor assembly may consist of a rod and fixed object or plate, typically embedded in the ground, which is attached to a guy strand or guy wire, which, in turn, is attached to the Pole. The term "Anchor" does not include the guy strand which connects the Anchor to the Pole.

2.2 An "Attachment" is any placement of MCI's Facilities in or on Sprint's Poles, Ducts, Conduits, or Right of Way.

2.3 A "Conduit" is a tube or protected trough that may be used to house communication cables. Conduit may be underground or above ground (e.g., inside buildings) and may contain one or more Inner Ducts.

2.4 A "Conduit System" is any combination of Ducts, Conduits, Manholes and Handholes joined to form an integrated whole. Conduit Systems may pass through or originate in or terminate in other Facilities which may be physically connected to the Conduit System.

2.5 A "Duct" is a single enclosed path to house Facilities to provide Telecommunications Services.

2.6 The terms "Facility" and "Facilities" refers to any property, equipment, or items owned or controlled by any person or entity. The terms "Facility" and "Facilities" include, but are not limited to, Poles, Anchors, Pole hardware, wires, cables, strands, apparatus enclosures, or any other items attached to a Pole or attached to hardware affixed to or associated with a Pole, Conduit and Conduit Systems and wires, cables, optical conductors, associated hardware, or other equipment located within a Conduit System. The terms "Facility" and "Facilities" may also include property, equipment, and items which do not occupy a Conduit System or

which are not attached to a Pole or attached to hardware affixed to or associated with a Pole.

2.7 A "Handhole" is a subsurface enclosure that is too small for personnel to enter and is used for the purpose of installing, operating, maintaining, and repairing communications Facilities.

2.8 An "Inner Duct" is one of the single enclosed pathways located within a Duct, or buried separately without the benefit of a Conduit.

2.9 The term "Make Ready Work" refers to all work performed or to be performed to prepare Sprint's Poles, Ducts, Conduits or other Right of Way for the requested occupancy or Attachment of MCI's Facilities. Make Ready Work includes, but is not limited to, clearing obstructions, the rearrangement, transfer, replacement, and removal of existing Facilities on a Pole or in a Conduit System where such work is required solely to accommodate MCI's Facilities. Make Ready Work may include the repair, or modification of Sprint's Facilities including, but not limited to, Conduits, Ducts, Manholes or the performance of other work required to make a Pole, Conduit or Duct usable for the placement of MCI's Facilities.

2.10 A "Manhole" is a subsurface enclosure that personnel may enter and use for the purpose of installing, operating, maintaining, and repairing communications Facilities.

2.11 A "Pole" refers to Sprint Poles and Anchors and does not include Poles or Anchors with respect to which Sprint has no legal authority to permit Attachments by other persons or entities.

2.12 A "Pole Attachment" is the connection of a Facility to a Pole. Some examples of such Facilities are mechanical hardware, grounding and transmission cable, and equipment boxes.

2.13 A "Right of Way" ("ROW") is the right to use the land or other property of another party to place Poles, Conduits, cables, or other structures and equipment, or to provide passage to access such structures and equipment for the purpose of providing Telecommunications Services. A ROW may run under, on, or above public or private property (including air space above public or private property) and may include the right to use discrete space in buildings, building complexes, or other locations.

### **Section 3. Requirements**

#### **3.1 General**

3.1.1 Sprint shall make Poles, Ducts, Conduits, Conduit Systems, and other ROW available to MCI for Attachments under the terms and conditions set forth in this Section 3.

3.1.2 Sprint shall provide MCI equal and non-discriminatory access to Poles, Ducts, Conduits, and other ROW it owns or controls. Such access shall be provided on terms and conditions equal to that provided by Sprint to itself or to any other party consistent with Section 224 of the Act. Further, Sprint shall not preclude or delay allocation of these Facilities to MCI because of the potential needs of itself or of other parties, except for work in progress, which may be retained for Sprint Facilities deployment within twelve (12) months of the date of the formal MCI request.

3.1.3 Each of the Parties shall designate to the other, on the basis of specific operating regions, single points of contact for negotiating all issues relating to implementation of this Section 3. The single points of contact shall also be the contacts for all notices and demands, offers and acceptances under this Section 3, unless otherwise agreed in writing by the Parties.

3.1.4 Excepting work in progress as described above, and maintenance and emergency Ducts as provided below, all usable but unassigned space on Poles, or in Ducts, Conduits, or other ROW owned or controlled by Sprint shall be available for the Attachments of MCI, Sprint or other providers of Telecommunications Services or cable television systems. Sprint may reserve for emergency and maintenance purposes one Duct in each Conduit section of its Facility routes. Such Duct shall be equally accessible and available to any party with Facilities in such Conduit section to be used to maintain its Facilities or to restore them in an emergency.

3.1.5 All MCI Facilities placed in or upon Sprint ROW shall be clearly tagged or labeled with MCI ownership identification so that it may be readily identified by Sprint or its contractors as MCI Facilities.

3.1.6 Access to Sprint Poles, Ducts, Conduits or other ROW by MCI or its designated personnel or contractors shall be provided on an escorted basis and upon a reasonable request for access to

such Poles, Ducts, Conduits or other ROW. MCI shall pay for one (1) access escort based on an hourly rate of the appropriate level of escorting personnel as determined by Sprint, but not to exceed \$75.00 per hour, unless Sprint and MCI have reached agreement that no escort is necessary, which may be negotiated on a case-by-case basis. Such escort service shall be available on a reasonable basis twenty-four (24) hours per day.

### **3.2 Pre-Ordering Disclosure Requirements**

**3.2.1** MCI may request information regarding the availability and conditions of Poles, Ducts, Conduits and other ROW prior to the submission of Attachment Requests (as defined below). Sprint shall provide information regarding the availability and condition of Sprint's Poles, Ducts, Conduits or other ROW for Attachments within fifteen (15) business days of a request. If it is unable to inform MCI about availability and conditions within such fifteen-day interval, Sprint shall advise MCI within ten (10) business days after receipt of MCI's information request and will seek a mutually satisfactory time period for Sprint's response, which in no event shall exceed thirty (30) calendar days. If Sprint's response requires a field-based survey, MCI shall have the option to be present at the field-based survey and Sprint shall provide MCI at least two (2) days notice prior to the start of such field survey. During and after the field-based survey, Sprint shall allow MCI personnel (with Sprint escort) to enter Manholes and view Pole structures to inspect such structures in order to confirm usability or assess the condition of the structure.

**3.2.2** Sprint shall make existing route maps of Poles, Ducts, Conduits or other ROW available to MCI, at a city level, at Sprint's Facilities within two (2) business days and if such maps need to be generated, within ten (10) business days of MCI's request. Preparation of such maps requested by MCI shall be accommodated by Sprint on a reasonable basis and at MCI's expense, plus a reasonable administrative fee. In making these maps and drawings available, Sprint makes no express or implied warranty as to the accuracy of these maps and drawings, except that they reflect the equivalent accuracy and timeliness of information used by Sprint in its operations.

**3.2.3** Sprint shall invoice MCI an administrative fee equal to fifty percent (50%) of the direct cost of providing maps and drawings, in addition to the direct cost of copying any requested maps or drawings.

### 3.3 Attachment Requests

3.3.1 Sprint agrees to permit MCIIm to place MCIIm's Facilities on or in Sprint's Poles, Ducts, Conduits, and other ROW pursuant to Attachment Requests from MCIIm approved in accordance with this Section 3.3, on the terms and conditions set forth herein.

3.3.2 At any time after the Effective Date, MCIIm may submit a written Attachment Request to Sprint. An Attachment Request shall be deemed properly submitted if it identifies with specificity the Sprint Poles, Ducts, Conduits, or other ROW for which MCIIm seeks Attachment. Sprint shall approve any properly submitted Attachment Request within ten (10) business days, if the space has previously been determined to be available under the procedures set forth in Section 3.2.1 of this Attachment VI above. No Attachments shall be placed on any Sprint Pole identified in an Attachment Request until the Attachment Request has been approved by Sprint. MCIIm may submit subsequent Attachment Requests as needed. MCIIm shall have fourteen (14) calendar days after Sprint's return of the approved Attachment Request to MCIIm to execute the Attachment Request and return the same to Sprint. If MCIIm does not return the Attachment Request within the fourteen (14) calendar day interval specified above, then such request shall be null and void and such ROW shall become immediately available to other parties. The Attachment Request shall serve as the binding attachment contract between the Parties and the form and format shall be agreed to as part of operating procedures.

3.3.3 Together with Sprint's notice of approval of an Attachment Request submitted by MCIIm, Sprint shall also provide an estimate of the Make Ready Work costs associated with making the space available for MCIIm's Attachment. Sprint shall complete any Make Ready Work required to enable MCIIm to install its Facilities at both a reasonable cost and within a reasonable time, both of which shall be agreed upon by Sprint and MCIIm. If such agreement does not occur within ten (10) calendar days of Sprint's provision of a quote for such work or MCIIm determines the quote is too high, MCIIm may complete Make Ready Work on its own or hire outside contractors to do the work at MCIIm's expense. Any contractors hired by MCIIm pursuant to this Section 3 shall meet Sprint's reasonable standards, which shall not exceed the equivalent personnel qualifications of Sprint personnel performing the same task. Where MCIIm submits an Attachment Request and subsequently fails to return an executed Attachment Request within

fourteen (14) days of Sprint's notice of approval, MCI shall reimburse Sprint for its reasonable cost to provide pre-ordering information and any site survey work and the Attachment Request shall become null and void. Upon acceptance of an approved Attachment Request by MCI and its return to Sprint, Sprint shall bill MCI for any Make Ready Work non-recurring charges, if Sprint is to perform the Make Ready Work. Upon completion of any required Make Ready Work by Sprint or upon receipt of the approved Attachment Request by Sprint, whichever is later, written notice shall be provided to MCI granting access to the ROW and advising MCI of the date that monthly billing for such ROW shall commence. MCI shall have six (6) months to begin Attachment and/or installation of its Facilities after receipt of such notice. Any such construction shall be completed by the end of one (1) year after receipt of such notice, unless MCI notifies Sprint differently and Sprint agrees to such delay. MCI notification to Sprint shall be provided at least sixty (60) days prior to the expiration of the one (1) year period. If MCI does not begin construction within this time frame, Sprint will cease monthly billing to MCI and the access to the ROW and the Attachment Request shall be deemed null and void.

3.3.4 Sprint shall make space available to MCI as soon as any Make Ready Work to be provided by Sprint, as described in Section 3.3.3, is completed. At that time, MCI shall have the right, subject to the terms and conditions of this Agreement, to place and maintain the Facilities described in the Attachment Request in the space designated on or in Sprint's Poles, Ducts, Conduits, and other ROW identified therein. MCI may, at its option, use MCI or MCI-designated personnel, which MCI shall identify to Sprint prior to beginning construction, to attach its equipment to Sprint structures, subject to Sprint's agreement with the proposed construction methods proposed by MCI to perform such work. Any such approval shall not be unreasonably withheld, delayed or denied.

3.3.5 If Sprint performs the Make Ready Work specified by Section 3.3.3, MCI agrees to pay Sprint the Make Ready Work costs within sixty (60) business days of receiving Sprint's invoice.

3.3.6 Sprint will provide MCI with answers to an environmental, health and safety questionnaire for each Sprint Facility in or on which MCI seeks an Attachment. MCI may provide this questionnaire with its Attachment Request and Sprint shall return it to MCI with the approval of MCI's Attachment Request.

### **3.4 Authority to Place Attachments**

3.4.1 Before MCI<sub>m</sub> places any Attachment pursuant to an approved Attachment Request, MCI<sub>m</sub> shall submit evidence of its authority to erect and maintain the Facilities to be placed on Sprint's Facilities within the public streets, highways and other thoroughfares or on private property, where such additional authority is required by law. MCI<sub>m</sub> shall be solely responsible for obtaining all necessary licenses, authorizations, permits, and consents from federal, state and municipal authorities that may be required to place Attachments on Sprint's Facilities.

3.4.2 Sprint shall not unreasonably intervene against or attempt to delay the granting of any necessary licenses, authorizations, permits or consents from federal, state and municipal authorities or private property owners that may be required for MCI<sub>m</sub> to place its Attachments on or in any Poles, Ducts, Conduits, or other ROW that Sprint owns or controls.

3.4.3 If any license, authorization, permit or consent obtained by MCI<sub>m</sub> is subsequently revoked or denied for any reason, permission to attach to Sprint's Facilities shall terminate immediately and MCI<sub>m</sub> shall remove its Attachments (if any) within one hundred twenty (120) days. MCI<sub>m</sub> may, at its option, litigate or appeal any such revocation or denial and if MCI<sub>m</sub> is diligently pursuing such litigation or appeal, MCI<sub>m</sub> may continue to maintain its Attachment. In doing so, MCI<sub>m</sub> agrees to indemnify Sprint from and against any and all costs resulting from Sprint's continuation of the Attachment which is the subject of such litigation or appeal.

### **3.5 Capacity**

3.5.1 When there is insufficient space on a Pole or in a Sprint Conduit to accommodate an MCI<sub>m</sub>-requested Attachment or occupancy, Sprint shall, at MCI<sub>m</sub>'s option: (1) replace the Pole or Conduit with one of greater height or capacity; (2) permit MCI<sub>m</sub> to replace the Pole or Conduit with a Sprint-furnished Pole or Conduit of greater height or capacity; or (3) place additional Poles or Conduits in the ROW. MCI<sub>m</sub> shall be obligated to reimburse Sprint for its proportionate share of the actual costs incurred.

3.5.2 Sprint shall permit MCI<sub>m</sub> to break out of Sprint Conduit and to maintain Facilities within Conduit space used by MCI<sub>m</sub> and, where required by Sprint, shall provide MCI<sub>m</sub> designated personnel with one (1) escort of the appropriate level whose cost shall not

exceed \$75.00 per hour. Such escort service shall be available twenty-four (24) hours per day each day of the week.

3.5.3 Sprint shall permit Manhole interconnections and breaking out of Sprint Manholes and shall provide MCIIm with sufficient space in Manholes for the racking and storage of cable and other materials as requested by MCIIm. Sprint reserves the right to deny nonstandard requests to break out of Manholes where the location in which MCIIm wants to break out is blocked by a cable rack.

3.5.4 Sprint shall take all reasonable measures to allow access and/or egress to all Conduit Systems. This shall include, but not be limited to, Sprint's removal, upon MCIIm's request, of any retired cable for Conduit Systems to allow for the efficient use of Conduit space within a reasonable period of time. If the Parties are unable to agree on what is reasonable (in terms of measures or time intervals), the matter may be submitted in accordance with the Dispute Resolution Procedures, described in Part A of this Agreement, by either Party.

3.5.5 Where a spare Inner Duct does not exist, Sprint shall allow installation of an Inner Duct in a spare Sprint Conduit. The procedure set forth in Section 3.3.3 shall govern such installation.

3.5.6 Neither Party shall attach, or permit other entities to attach Facilities on existing Facilities of the other without the other Party's prior written consent. Such consent will not be unreasonably withheld if the requested use is to facilitate use of the ROW by Sprint or any other party on a temporary basis until such reasonable time as the ROW can be expanded.

3.5.7 MCIIm acknowledges that, from time to time, it may be necessary or desirable for Sprint to change out Poles, relocate, reconstruct, or modify portions of its Conduit System or rearrange Facilities contained therein or connected thereto and that such changes may be necessitated by Sprint's business needs or by factors outside of Sprint's control, such as the decision by a municipality to widen streets or authorized application of another entity seeking access to Sprint's Poles or Conduit Systems. MCIIm agrees that MCIIm will, upon Sprint's request and at Sprint's expense, but at no cost to MCIIm so long as no additional cost is incurred by Sprint as a result of MCIIm being attached, participate with Sprint (and other licensees) in the relocation, reconstruction, or modification of Sprint's Conduit System or Facilities rearrangement.



### **3.6 Sharing of Right of Way**

Sprint shall offer the use of such ROW it has obtained from a third party to MCI, to the extent that Sprint's agreement with the third party explicitly permits Sprint to grant such rights to MCI. If said third party agreement does not explicitly permit Sprint to grant such rights to MCI, Sprint will, upon MCI's request, grant said rights to MCI provided that MCI agrees, in writing, to indemnify, defend and hold Sprint harmless from and against any loss, cost, claim, liability, damage and expense (including reasonable attorney fees) to third parties relating to or arising out of the grant of such right of use to MCI.

### **3.7 Emergency Situations**

3.7.1 Within fifteen (15) business days after the Effective Date, Sprint and MCI shall mutually agree on a non-discriminatory priority method to access Sprint Manholes and Conduits in emergency situations.

### **3.8 Attachment Fees**

3.8.1 MCI shall pay Sprint an Attachment fee consistent with the Act and the FCC's implementing rules and regulations promulgated thereunder, for each Sprint Facility upon which MCI obtains authorization to place an Attachment. The Parties agree that any new FCC rules and regulations setting forth a new methodology for determining the Attachment fee shall govern the establishment of the pricing of Attachments.

3.8.2 Sprint shall maintain an inventory of the Sprint Facilities occupied by MCI based upon the cumulative Facilities specified in all Attachment Requests approved in accordance with Section 3.3. MCI shall have the right to remove any Attachment at any time, and it shall be MCI's sole responsibility to notify Sprint of any and all removals by MCI of its Attachments from Sprint's Facilities. Such notice shall be provided to Sprint at least thirty (30) days prior to the removal of the Attachment and shall take the form of a notice of removal. MCI shall remain liable for an Attachment fee for each Sprint Facility included in all approved Attachment Requests until a notice of removal has been received by Sprint or MCI cancels an Attachment pursuant to Section 3.13. Sprint may, at its option, conduct a physical inventory of the Attachments for purposes of determining the Attachment fees to be paid by MCI under this Section 3.

### **3.9 Additions and Modifications to Existing Attachments**

3.9.1 MCIIm shall not modify, add to or replace Facilities on any pre-existing Attachment without first notifying Sprint in writing of the intended modification, addition or replacement at least thirty (30) days prior to the date the activity is scheduled to begin. The required notification shall include: (1) identification of the impacted Attachment; (2) the date the activity is scheduled to begin; (3) a description of the planned modification, addition or replacement; (4) a representation that the modification, addition or replacement will not require any space other than the space previously designated for MCIIm's Attachments; and (5) a representation that the modification, addition or replacement will not impair the structural integrity of the Facilities involved.

3.9.2 If the modification, addition or replacement specified by MCIIm in its notice will require more space than that currently allocated to MCIIm or will require the reinforcement or replacement of or an addition of support equipment to the Facilities involved in order to accommodate MCIIm's modification, addition or replacement, MCIIm will submit a Attachment Request in compliance with Section 3.3 in order to obtain authorization for the modification, addition or replacement of its Facilities.

### **3.10 Noncompliance**

3.10.1 If, at any time, Sprint determines that MCIIm's Facilities or any part thereof have not been placed or maintained or are not being used in accordance with the requirements of this Section 3, Sprint may send written notice to MCIIm specifying the alleged noncompliance. If MCIIm does not dispute Sprint's assertion in writing within thirty (30) calendar days of receipt thereof, MCIIm will, within sixty (60) calendar days of receipt of the notice of noncompliance, provide Sprint with a schedule for bringing MCIIm's Facilities into compliance (which schedule shall be subject to Sprint's agreement, which agreement shall not be unreasonably withheld) and shall bring such Facilities into compliance within the time periods specified in such schedule.

3.10.2 If MCIIm disputes Sprint's assertion of noncompliance, MCIIm shall notify Sprint of the basis of MCIIm's belief that MCIIm's Facilities are compliant. If the Parties are unable to agree on whether a noncompliance exists within thirty (30) calendar days of receipt of the noncompliance notice by MCIIm, then the issue shall

be resolved pursuant to the Dispute Resolution Procedures set forth in Part A of this Agreement.

### **3.11 Surveys and Inspections of Attachments**

3.11.1 The exact location of Attachments on or in Sprint's Facilities may be determined through a survey (at Sprint's expense) to be made not more than once per calendar year by Sprint. If so requested, MCIIm and/or any other entity owning or jointly owning the Facilities with Sprint may participate in the survey.

3.11.2 Apart from surveys conducted in accordance with Section 3.11.1 above, Sprint shall have the right to inspect (at Sprint's expense) any Attachment on or in Sprint's Facilities as conditions may warrant upon written notice to MCIIm. No joint survey or inspection by Sprint shall operate to relieve MCIIm of any responsibility, obligation or liability assumed under this Agreement.

### **3.12 Notice of Modification or Alteration of Poles, Ducts, Conduits, or Other ROW by Sprint**

3.12.1 If Sprint plans to modify or alter any Sprint Facilities upon which MCIIm has Attachments, Sprint shall provide MCIIm notice of the proposed modification or alteration at least sixty (60) calendar days prior to the time the proposed modification or alteration is scheduled to take place. If MCIIm decides not to modify or add to its existing Attachment, MCIIm shall participate at no cost in such modification and rearrangement. If MCIIm adds to or modifies its Facilities MCIIm shall be charged its proportionate share of the reasonable costs incurred by Sprint for such modification or rearrangement. MCIIm shall make all rearrangements of its Facilities within such period of time, which shall not be less than sixty (60) calendar days, as is jointly determined to be reasonable by the Parties based on the amount of rearrangements necessary and a desire to minimize chances for service interruption or Facility-based service denial to an MCIIm customer.

### **3.13 Termination of Section 3 or an Individual Attachment by MCIIm**

3.13.1 This Section 3 may be terminated by MCIIm any time prior to the expiration of its term by providing written notice to Sprint of its intent to terminate not less than ninety (90) days prior to the date such termination is to become effective. Within one hundred twenty (120) days after the date this Section 3 is terminated, MCIIm shall cause all of its Attachments to be removed from all of Sprint's

**Poles.** In the event MCIIm fails to remove its Attachments as required by this Section 3, Sprint shall have the option to remove all such Attachments and store them in a public warehouse or elsewhere at the expense of and for the account of MCIIm without Sprint being deemed guilty of trespass or conversion, and without Sprint becoming liable for any loss or damages to MCIIm occasioned thereby.

3.13.2 MCIIm may, at any time, terminate an Attachment under this Agreement upon thirty (30) calendar days notice to Sprint. Upon removal of such Attachment, all fees for such Attachment shall cease.

### **3.14 Abandonment**

3.14.1 Nothing in this Agreement shall prevent or be construed to prevent Sprint from abandoning, selling, assigning or otherwise disposing of any Poles, Conduit Systems, or other Sprint property used for Attachments, provided, however, that Sprint shall condition any such sale, assignment or other disposition subject to the rights granted to MCIIm pursuant to this Agreement. Sprint shall promptly notify MCIIm of any proposed sale, assignment or other disposition of any Facilities or other Sprint property used for MCIIm's Attachments.

### **3.15 Dispute Resolution Procedures**

3.15.1 If either Party has declared the other in default of any provisions of this Attachment VI, or has otherwise notified the other Party that it is not in compliance with the terms of this Section 3, either Party may invoke the Dispute Resolution Procedures, described in Part A of this Agreement, or the procedures described in the Act, the FCC's First Interconnection Order, §1217-1231 and the FCC's Rules at 47 CFR § 1.1401-1.1416. In the event either Party invokes the Dispute Resolution Procedures as provided herein, Sprint will continue to process Attachment Requests pursuant to this Section 3.

3.15.2 Sprint will not be relieved of its obligations to process Attachment Requests by MCIIm if MCIIm is alleged to be in default of this Section 3 for nonpayment of fees and charges due Sprint under this Section 3, so long as such default is: (1) the subject of Dispute Resolution Procedures as set forth in Part A of this Agreement; or (2) being adjudicated before the FCC or any other

court, regulatory body, agency, or tribunal having jurisdiction over such dispute.

**TABLE OF CONTENTS**

**Attachment VII  
NUMBER PORTABILITY**

Section 1.	Sprint Provision of Number Portability	VII-1
Section 2.	Interim Number Portability ("INP")	VII-1
Section 3.	Number Portability ("NP")	VII-3
Section 4.	Requirement for INP and NP	VII-4

## ATTACHMENT VII

### NUMBER PORTABILITY

#### **Section 1. *Sprint Provision of Number Portability***

1.1 Sprint shall provide number portability in accordance with requirements of the Act and FCC Rules and Regulations. Currently available interim number portability ("INP") shall be provided by Sprint to MCI in accordance with FCC Rules and Regulations. INP shall be provided with minimum impairment of functionality, quality, reliability and convenience to subscribers of MCI services. Sprint shall provide number portability in conformance with FCC Rules and Regulations and the Act.

#### **Section 2. *Interim Number Portability ("INP")***

2.1 INP shall be provided by Remote Call Forwarding ("RCF") or Direct Inward Dialing ("DID") or upon request, Route Indexing ("RI"), if technically feasible. MCI shall specify on a per telephone number basis which method of INP is to be employed and Sprint shall provide such method to the extent technically feasible.

2.2 **Remote Call Forwarding.** Remote Call Forwarding ("RCF") is an INP method to provide subscribers with service-provider portability by redirecting calls within the telephone network. When RCF is used to provide interim number portability, calls to the ported number will first route to the Sprint switch to which the ported number was previously assigned. The Sprint switch will then forward the call to a number associated with the MCI designated switch to which the number is ported. MCI may order any additional paths to handle multiple simultaneous calls to the same ported telephone number.

2.3 **Direct Inward Dialing.** DID is an INP method that makes use of direct inward dialing trunks. Each DID trunk group used for INP is dedicated to carrying FLEX-DID INP traffic between the Sprint end office and the MCI switch. Traffic on these trunks cannot overflow to other trunks, so the number of trunks shall be conservatively engineered by Sprint. Also, inter-switch signaling is usually limited to multi-frequency ("MF"). This precludes passing CLID to the MCI switch.

**2.4 Route Indexing.** Route Indexing may take two forms: Route Index-Portability Hub ("RI-PH") or Directory Number-Route Index ("DN-RI"). Route Indexing may be offered, upon request, once joint trials between Sprint and MCI or another CLEC have yielded mutually agreeable results. Trialing will include, but is not limited to, issues of interoperability requirements, trunking (*i.e.*, one way or two way), and signaling (*i.e.*, inband or SS7).

2.4.1 RI-PH will route a dialed call to the Sprint switch associated with the NXX of the dialed number. The Sprint switch shall then insert a prefix onto the dialed number which identifies how the call is to be routed to MCI. The prefixed dialed number is transmitted to the Sprint tandem switch to which MCI is connected. The prefix is removed by the operation of the tandem switch and the dialed number is routed to MCI's switch so the routing of the call can be completed by MCI.

2.4.2 DN-RI is a form of RI-PH that requires direct trunking between the Sprint switch to which the ported number was originally assigned and the MCI switch to which the number has been ported. The Sprint switch shall send the originally dialed number to the MCI switch without a prefix.

2.4.3. In the joint trials, MCI and Sprint will agree upon the type of Route Indexing that will be supported by Sprint. Sprint shall provide RI-PH or DN-RI on an individual telephone number basis. Where technically feasible, MCI may designate that calls to ported numbers are first directed to the MCI switch over direct trunks but may overflow to tandem trunks if all trunks in the direct group are occupied.

2.4.4 The trunking requirements will be agreed upon by Sprint and MCI resultant from trialing. These trunking options may include SS7 signaling, inband signaling, and may be one way or two way. For either RI-PH or DN-RI, the trunks used may be the same as those used for exchange of other Local Traffic and toll traffic between Sprint and MCI.

**2.5 LERG Reassignment.** Portability for an entire NXX shall be provided by utilizing reassignment of the block to MCI through the Local Exchange Routing Guide ("LERG"). Updates to translations in the Sprint switching office from which the telephone number is ported will be made by Sprint prior to the date on which LERG changes become effective, in order to redirect calls to the MCI switch via route indexing.



## 2.6 Other Currently Available Number Portability Provisions

2.6.1 Where SS7 is available, Sprint shall exchange with MCI, SS7 TCAP messages as required for the implementation of Custom Local Area Signaling Services ("CLASS") or other features available in the Sprint network, if technically feasible.

2.6.2 Upon notification that MCI will be initiating INP, Sprint shall disclose to MCI any technical or capacity limitations that would prevent use of the requested INP in the affected switching office. Sprint and MCI shall cooperate in the process of porting numbers to minimize subscriber out-of-service time, including updating switch translations where necessary within five (5) minutes after notification that physical cut-over has been completed (or initiated), as MCI may designate.

2.6.3 For INP, MCI shall have the right to use the existing Sprint 911 infrastructure for all 911 capabilities. When RCF is used for MCI subscribers, both the ported numbers and shadow numbers shall be stored in ALI databases. MCI shall have the right to verify the accuracy of the information in the ALI databases.

2.6.4 When any INP method is used to port a subscriber, the donor provider must maintain the Line Information Database ("LIDB") record for that number to reflect appropriate conditions as reported to it by the porting service provider. The donor must outclear call records to MCI for billing and collection from the subscriber. Until such time as Sprint's LIDB has the software capability to recognize a ported number as MCI's, Sprint shall store the ported number in its LIDB at no charge and shall retain revenue for LIDB look-ups to the ported number. At such time as Sprint's LIDB has the software capability to recognize that the ported number is MCI's then, if MCI desires to store numbers on Sprint's LIDB, the Parties shall negotiate a separate LIDB database storage and look-up agreement.

2.6.5 Sprint should send a CARE transaction 2231 to notify the IXC that access is now provided by a new CLEC for that number.

### **Section 3. Number Portability ("NP")**

3.1 Number Portability is currently being worked in industry forums. The results of these forums will dictate the industry direction for Number Portability. Sprint agrees to implement Number Portability as directed by

the FCC in Docket 95-116, the appropriate industry forums, and state sponsored Number Portability workshops including Illinois.

#### **Section 4. Requirements for INP and NP**

##### **4.1 Cut-Over Process**

Sprint and MCI shall cooperate in the process of porting numbers from one carrier to another so as to limit service outage for the ported subscriber.

4.1.1 For a Coordinated Cutover Environment, Sprint shall verbally coordinate with MCI the disconnect and switch translations as close to the requested time as possible. The coordination shall be pre-specified by MCI and agreed to by both Parties and in no case shall begin more than twenty (20) minutes after the agreed upon time.

4.1.2 For a Non-Coordinated Cutover Environment, Sprint shall schedule a mechanized update of disconnect and switch translations at the MCI requested cutover time. Such updates will be available to MCI at Parity with Sprint's own availability for such activity. Sprint shall provide an operations contact whom MCI can reach in the event manual intervention is needed to complete the cutover. In the event of manual intervention, and if Sprint is unable to resolve the issue within sixty (60) minutes, Sprint shall notify MCI of the issue and MCI and Sprint shall determine the plan to resolve it.

##### **4.2 Testing**

Sprint and MCI shall cooperate in conducting MCI's testing to ensure interconnectivity between systems. Sprint shall inform MCI of any system updates that may affect the MCI network and Sprint shall, at MCI's request, perform tests to validate the operation of the network. Additional testing requirements may apply as specified by this Agreement.

##### **4.3 Installation Time Frames**

4.3.1 If the installation of RCF INP must be coordinated with the installation of another Sprint provided service, then the applicable installation time frame shall be that of the other Sprint service being installed, or as mutually agreed when no such time frame has been previously established. Otherwise, the installation time frames for

RCF INP shall be developed pursuant to the Implementation Plan as described in Part A, Section 34.

4.3.2 If a subscriber elects to move its Telephone Exchange Service back to Sprint while on an INP arrangement, Sprint shall notify MCI of the Subscriber's termination of service with MCI and the Subscriber's instructions regarding its telephone number(s) within two (2) business days of receiving notification from the Subscriber.

#### **4.4 Call Referral Announcements**

Sprint shall allow MCI to order all referral announcements, and specify the particular announcement from Sprint's standard set of call referral announcement options, on a per telephone number basis, for telephone numbers which MCI has ported from Sprint to MCI and for which INP measures have, at MCI's direction, been terminated.

#### **4.5 Engineering and Maintenance**

Sprint and MCI will cooperate to ensure that performance of trunking and signaling capacity is engineered and managed at levels which are at least at Parity with that provided by Sprint to its subscribers and to ensure effective maintenance testing through activities such as routine testing practices, network trouble isolation processes and review of operational elements for translations, routing and network fault isolation.

#### **4.6 Operator Services and Directory Assistance**

With respect to operator services and directory assistance associated with NP for MCI subscribers, Sprint shall provide the following:

##### **4.6.1 While INP is deployed and prior to conversion to NP:**

4.6.1.1 Sprint shall allow MCI to order provisioning of Telephone Line Number ("TLN") calling cards and Billed Number Screening ("BNS"), in its LIDB, for ported numbers, as specified by MCI. Sprint shall continue to allow MCI access to its LIDB. Other LIDB provisions are specified in this Agreement; and

4.6.1.2 Where Sprint has control of Directory Listings for NXX codes containing ported numbers, Sprint shall maintain entries for ported numbers as specified by MCI.

#### **4.7 Number Reservation**

4.7.1 When a subscriber ports to another service provider and has previously secured a reservation of line numbers from the donor provider for possible activation at some future point, these reserved but inactive numbers shall "port" along with the active numbers being ported by the subscriber in order to ensure that the end user subscriber will be permitted to expand its service using the same number range it could use if it remained with the donor provider.

<b>SECTION 1. GENERAL BUSINESS REQUIREMENTS</b>	<b>1</b>
<b>1.1 Procedures</b>	<b>1</b>
1.1.1 Sprint Contact with Subscribers	1
1.1.2 Expedite, Escalation, and Disaster Procedures	1
1.1.3 Operational and Technological Changes	2
1.1.4 Subscriber of Record	2
1.1.5 Work Center Interface Procedures	2
<b>1.2 Service Offerings</b>	<b>2</b>
1.2.1 Changes in Retail Service Offerings	2
1.2.2 Essential Services	3
1.2.3 TTY/TDD	3
1.2.4 Blocking Services	3
1.2.5 Training Support	4
1.2.6 Carrier Identification Codes	4
<b>SECTION 2. ORDERING AND PROVISIONING</b>	<b>4</b>
<b>2.1 General Business Requirements</b>	<b>4</b>
2.1.1 Ordering and Provisioning Parity	4
2.1.2 Local Carrier Service Center ("LCSC")/Single Point of Contact ("SPOC")	5
2.1.3 Street Address Guide ("SAG")	5
2.1.4 CLASS and Custom Features	6
2.1.5 Subscriber Payment History	6
2.1.6 Carrier Selection	7
2.1.7 Notification to Long Distance Carrier	7
2.1.8 Number Administration/Number Reservations	8
<b>2.2 Service Order Process Requirements</b>	<b>9</b>
2.2.1 OBF Compliance	9
2.2.2 Service Migrations and New Subscriber Additions	9
2.2.3 Intercept Treatment and Transfer of Service Announcements	10
2.2.4 Desired Due Date ("DDD")	10
2.2.5 Subscriber Premises Inspections and Installations	11
2.2.6 Firm Order Confirmation ("FOC")	11
2.2.7 Order Rejections	12
2.2.8 Service Order Changes	12
2.2.9 Jeopardy Situations	13
2.2.10 Cooperative Testing	13
2.2.11 Service Suspensions/Restorations	13
2.2.12 Disconnects	14
2.2.13 Order Completion Notification	14
2.2.14 Fulfillment Process	14
2.2.15 Specific Unbundling Requirements	14
<b>2.3 Systems Interfaces and Information Exchanges</b>	<b>16</b>
2.3.1 General Requirements	16
2.3.2 Ordering and Provisioning for Resale Services	17
2.3.3 Ordering and Provisioning for Unbundling	21

<b>2.4 Standards</b>	<b>21</b>
2.4.1 General Requirements	21
<b>2.5 Performance Measurements and Reporting</b>	<b>22</b>
2.5.1 Cycle Time Measurements	22
2.5.2 Quality Measurements	23
<b>SECTION 3. CONNECTIVITY BILLING AND RECORDING</b>	<b>23</b>
<b>3.1 Procedures</b>	<b>23</b>
<b>3.2 Information Exchange and Interfaces</b>	<b>29</b>
<b>3.3 Standards</b>	<b>32</b>
<b>3.4 Revenue Protection</b>	<b>33</b>
<b>SECTION 4. PROVISION OF SUBSCRIBER USAGE DATA</b>	<b>34</b>
<b>4.1 Procedures</b>	<b>34</b>
4.1.1 General	34
4.1.2 Charges	36
4.1.3 Central Clearinghouse & Settlement	36
4.1.4 Lost Data	37
4.1.5 Testing, Changes and Controls	38
<b>4.2 Information Exchange and Interfaces</b>	<b>41</b>
4.2.1 Core Billing Information	41
4.2.2 Product/Service Specific	41
4.2.3 Emergency Information	42
4.2.4 Rejected Recorded Usage Data	42
4.2.5 Interfaces	43
4.2.6 Formats & Characteristics	43
4.2.7 Controls	45
4.2.8 Interim Number Portability Recording and Billing	46
<b>4.3 Standards</b>	<b>47</b>
<b>4.4 Performance Measurements</b>	<b>47</b>
<b>4.5 Reporting</b>	<b>47</b>
<b>SECTION 5. MAINTENANCE</b>	<b>47</b>
<b>5.1 General Requirements</b>	<b>47</b>
<b>5.2 Systems Interfaces and Information Exchanges</b>	<b>52</b>
<b>5.3 Standards</b>	<b>54</b>
<b>5.4 Performance Measurements and Reporting</b>	<b>54</b>



**Section 1. General Business Requirements**

**1.1 Procedures**

**1.1.1 Sprint Contact with Subscribers**

1.1.1.1 MCIIm at all times shall be the primary contact and account control for all interactions with its subscribers, except as specified by MCIIm. MCIIm subscribers include active MCIIm subscribers, as well as those for whom service orders are pending.

1.1.1.2 Each Party shall ensure that any of its personnel who may receive inquires from the other Party's subscriber regarding the service provided by the other Party to said subscriber or who may otherwise have opportunity for contact with the other Party's subscribers, regarding services provided by the other Party (i) provide appropriate referrals to and telephone numbers of the other Party to the subscriber making such inquires; (ii) do not in any way disparage or discriminate against the other Party, its product or services; and (iii) do not provide information about such Party's own products or services during the same inquiry or subscriber contact.

1.1.1.3 Sprint shall not use MCIIm's request for subscriber information, order submission, or any other aspect of MCIIm's processes or services to aid Sprint's marketing or sales efforts.

**1.1.2 Expedite, Escalation, and Disaster Procedures**

1.1.2.1 No later than thirty (30) days after the Effective Date of this Agreement, Sprint and MCIIm shall develop mutually acceptable escalation and expedite procedures which may be invoked at any point in the service ordering, provisioning, maintenance, and subscriber usage data transfer processes to facilitate rapid and timely resolution of disputes. In addition, Sprint and MCIIm will establish intercompany contact lists for purposes of handling subscriber and other matters which require attention/resolution outside of normal business procedures within thirty (30) days after the Effective Date of this Agreement. Each Party shall notify the other Party of any changes to its escalation contact list at least one (1) week before such changes are effective.



5.4.1 Cycle Time Measurements	54
5.4.2 Quality	55
<b>SECTION 6. MISCELLANEOUS SERVICES &amp; FUNCTIONS</b>	<b>56</b>
<b>6.1 General</b>	<b>56</b>
<b>6.2 General Requirements</b>	<b>56</b>
6.2.1 Basic 911 and E911 General Requirements	56
6.2.2 Directory Assistance Service	63
6.2.3 Operator Services	66
6.2.4 Directory Assistance and Listings Service Requests	69
6.2.5 Directory Listings General Requirements	72
6.2.6 Directory Assistance Data	73
<b>6.3 Systems Interfaces and Exchanges</b>	<b>75</b>
6.3.1 Directory Assistance Data Information Exchanges and Interfaces	75
<b>6.4 Systems Security</b>	<b>83</b>
<b>6.5 Law Enforcement Interface</b>	<b>84</b>

## **Section 1. General Business Requirements**

### **1.1 Procedures**

#### **1.1.1 Sprint Contact with Subscribers**

1.1.1.1 MCIIm at all times shall be the primary contact and account control for all interactions with its subscribers, except as specified by MCIIm. MCIIm subscribers include active MCIIm subscribers, as well as those for whom service orders are pending.

1.1.1.2 Each Party shall ensure that any of its personnel who may receive inquiries from the other Party's subscriber regarding the service provided by the other Party to said subscriber or who may otherwise have opportunity for contact with the other Party's subscribers, regarding services provided by the other Party (i) provide appropriate referrals to and telephone numbers of the other Party to the subscriber making such inquiries; (ii) do not in any way disparage or discriminate against the other Party, its product or services; and (iii) do not provide information about such Party's own products or services during the same inquiry or subscriber contact.

1.1.1.3 Sprint shall not use MCIIm's request for subscriber information, order submission, or any other aspect of MCIIm's processes or services to aid Sprint's marketing or sales efforts.

#### **1.1.2 Expedite, Escalation, and Disaster Procedures**

1.1.2.1 No later than thirty (30) days after the Effective Date of this Agreement, Sprint and MCIIm shall develop mutually acceptable escalation and expedite procedures which may be invoked at any point in the service ordering, provisioning, maintenance, and subscriber usage data transfer processes to facilitate rapid and timely resolution of disputes. In addition, Sprint and MCIIm will establish intercompany contact lists for purposes of handling subscriber and other matters which require attention/resolution outside of normal business procedures within thirty (30) days after the Effective Date of this Agreement. Each Party shall notify the other Party of any changes to its escalation contact list at least one (1) week before such changes are effective.

1.1.2.2 No later than thirty (30) days after the Effective Date of this Agreement, Sprint and MCI shall jointly establish contingency and disaster recovery plans for those cases in which normal service ordering, provisioning, maintenance, billing, and other procedures for Sprint's unbundled Network Elements, features, functions, and resale services are inoperable.

### **1.1.3 Operational and Technological Changes**

1.1.3.1 Sprint shall notify MCI of any operational or technological changes (e.g., network, systems interfaces) that are related to any services or Network Elements purchased by MCI no less than twelve (12) months before Sprint plans to implement such change. The Parties may mutually agree to shorter notice periods.

### **1.1.4 Subscriber of Record**

1.1.4.1 Sprint shall recognize MCI as the subscriber of record for all Network Elements or services for resale ordered by MCI and shall send all notices, invoices, and information which pertain to such ordered services directly to MCI. MCI will provide Sprint with addresses to which Sprint shall send all such notices, invoices, and information.

### **1.1.5 Work Center Interface Procedures**

1.1.5.1 Sprint and MCI shall, within sixty (60) days of the Effective Date of this Agreement, develop and implement work center interface procedures for each function/business process.

## **1.2 Service Offerings**

### **1.2.1 Changes in Retail Service Offerings**

1.2.1.1 Sprint shall notify MCI of any proposed changes in the terms and conditions under which Sprint offers Telecommunications Services to subscribers who are not Telecommunications Service providers or carriers including, but not limited to, the introduction or discontinuance of any features, functions, or services, or changes in retail rates, upon Sprint's filing of such change or changes with the

Commission, or as required by state regulatory agency notification guidelines, whichever is earlier.

1.2.1.2 Sprint shall notify MCIIm of any proposed changes in the terms and conditions under which it offers unbundled Network Elements including, but not limited to, the introduction or discontinuance of any features, functions, services, promotions, or changes in rates upon Sprint's filing of such change with the Commission, or as required by state notification guidelines, whichever is earlier.

1.2.1.3 Sprint shall provide MCIIm with access to new services, features and functions concurrent with Sprint's notice to MCIIm of such changes, if such service, feature or function is installed and available in the network or as soon thereafter as it is installed and available in the network, so that MCIIm may conduct market testing.

#### **1.2.2 Essential Services**

1.2.2.1 Sprint shall designate an access line as an Essential Service Line ("ESL"), as such term is defined under applicable state law or regulation, upon MCIIm's request and at Parity with Sprint's treatment of its own subscribers with regard to ESL.

#### **1.2.3 TTY/TDD**

1.2.3.1 Sprint shall cooperate with MCIIm to provide Telecommunications Services at Parity to serve TTY/TDD subscribers.

#### **1.2.4 Blocking Services**

1.2.4.1 Upon request from MCIIm, Sprint shall provide blocking of 700, 900, and 976 services, or other services of similar type as may now exist or be developed in the future, and shall provide Billed Number Screening ("BNS"), including required LIDB updates, or equivalent service for blocking completion of bill-to-third party and collect calls, on a line, PBX, or individual service basis. Blocking shall be provided to the extent: (a) it is an available option for the Telecommunications Service resold by MCIIm; or (b) it is Technically Feasible when requested by MCIIm as a function of unbundled Network Elements.

### **1.2.5 Training Support**

1.2.5.1 Sprint shall provide training, on a non-discriminatory basis, for all Sprint employees who may communicate, either by telephone or face-to-face, with MCIIm subscribers. Such training may utilize training materials provided by MCIIm, and shall include compliance with the branding requirements of this Agreement including, without limitation, provisions of forms, business cards and "not at home" notices.

1.2.5.2 Sprint shall train MCIIm employees at a Sprint location on any Sprint-owned or -developed systems and processes non-industry standard and which need to be used by MCIIm's employees or agent to carry out this Agreement and shall provide at least the same information available to Sprint employees. Sprint shall provide training to up to two (2) MCIIm employees, including all necessary updates to such training, at no charge. MCIIm will bear any and all travel expenses incurred by or on behalf of such employees in connection with attendance at such training sessions.

### **1.2.6 Carrier Identification Codes**

1.2.6.1 Sprint shall provide to MCIIm the active Codes ("CIC") for both Dial 1 and 800 services for each of its access tandems and shall provide updates promptly as those codes change from time to time.

## ***Section 2. Ordering and Provisioning***

### **2.1 General Business Requirements**

#### **2.1.1 Ordering and Provisioning Parity**

2.1.1.1 During the term of this Agreement, Sprint shall provide necessary ordering and provisioning business process support as well as those technical and systems interfaces as may be required to enable MCIIm to provide at least the same level and quality of service for all resale services, functions, features, capabilities and unbundled Network Elements as Sprint provides itself, its Affiliates or its own subscribers. Sprint shall provide MCIIm with the same level of ordering and provisioning support as Sprint provides itself in accordance with standards and performance measurements that are at least equal to the highest level of

standards and/or performance measurements that Sprint uses and/or which are required by law, regulatory agency, or by Sprint's own internal procedures, whichever are the most rigorous. These standards shall apply to the quality of the technology, equipment, facilities, processes, and techniques (including, but not limited to, such new architecture, equipment, facilities, and interfaces as Sprint may deploy) that Sprint provides to MCI<sub>m</sub> under this Agreement.

### **2.1.2 Local Carrier Service Center ("LCSC")/Single Point of Contact ("SPOC")**

2.1.2.1 Sprint shall provide a Local Carrier Service Center ("LCSC") or its equivalent which shall serve as MCI<sub>m</sub>'s Single Point of Contact ("SPOC") for all activities involved in the ordering and provisioning of Sprint's unbundled Network Elements, features, functions, and resale services. MCI<sub>m</sub> shall have the ability to submit orders twenty-four (24) hours a day, seven (7) days a week.

2.1.2.2 The SPOC shall provide to MCI<sub>m</sub> a nationwide telephone number (available from 6:00 a.m. to 8:00 p.m. Eastern Standard Time, Monday through Friday, and 8:00 a.m. through 5:00 p.m. Eastern Standard Time on Saturday) answered by competent, knowledgeable personnel and trained to answer questions and resolve problems in connection with the ordering and provisioning of unbundled Network Elements (except those associated with local trunking interconnection), features, functions, capabilities, and resale services.

2.1.2.3 Sprint shall provide, as requested by MCI<sub>m</sub>, through the SPOC, provisioning and premises visit installation support in the form of coordinated scheduling, status, and dispatch capabilities during Sprint's standard business hours and at other times to meet subscriber demand as agreed upon by the Parties.

### **2.1.3 Street Address Guide ("SAG")**

2.1.3.1 Within thirty (30) days after the Effective Date of this Agreement, or as otherwise mutually agreed, Sprint shall provide to MCI<sub>m</sub> the SAG data, or its equivalent, in an electronic format mutually agreeable to the Parties. All

changes and updates to the SAG shall be provided in a mutually agreed format and time frame.

#### **2.1.4 CLASS and Custom Features**

2.1.4.1 MCI may order the entire set of CLASS, CENTREX and custom features and functions, or a subset of any one or any Combination of such features.

#### **2.1.5 Subscriber Payment History**

2.1.5.1 Upon mutual agreement by the Parties as to the manner and timing of implementation, and unless prohibited by applicable law, rule or regulation, MCI and Sprint will make available to a mutually agreed upon third party credit reporting agency, or in another manner as the Parties may mutually agree, on a timely basis, subscriber payment history information regarding the Party's relationship with such subscriber that is available for each person or entity that applies for local service or IntraLATA toll Telecommunications Service(s) from either carrier including for example:

2.1.5.1.1 Applicant's name;

2.1.5.1.2 Applicant's address;

2.1.5.1.3 Applicant's previous phone number, if any;

2.1.5.1.4 Amount, if any, of unpaid balance in the applicant's name;

2.1.5.1.5 Whether the applicant is delinquent on payments;

2.1.5.1.6 Length of service with the reporting Party;

2.1.5.1.7 Whether applicant had local or IntraLATA toll service terminated or suspended within the last six (6) months with an explanation of the reason therefore; and

2.1.5.1.8 Whether applicant was required by prior local or IntraLATA toll provider to pay a deposit or

make an advance payment, including the amount of each.

2.1.5.2 Such information shall be provided on the condition that the credit reporting agency only make such information available to the carrier to which the person or entity in question has applied for Telecommunications Service.

2.1.5.3 Sprint shall not refuse service to MCIIm for any potential MCIIm subscriber on the basis of that subscriber's past payment history with Sprint. MCIIm shall establish the credit scoring criteria for applicants for MCIIm services.

#### **2.1.6 Carrier Selection**

2.1.6.1 For services for resale or unbundled Network Elements, Sprint shall provide to MCIIm, no later than January 1, 1997, the capability to order local service, IntraLATA (where available), InterLATA, and international toll services by entering the MCIIm subscriber's choice of carrier on a single order. Sprint shall provide MCIIm with the capability to order separate InterLATA and IntraLATA carriers on a line or trunk basis.

2.1.6.2 Where IntraLATA toll carrier selection is not implemented, Sprint agrees to provide IntraLATA toll services for resale to MCIIm. In all cases, Sprint will route toll calls to the appropriate carrier as designated by MCIIm.

#### **2.1.7 Notification to Long Distance Carrier**

2.1.7.1 Sprint agrees to notify MCIIm using OBF-approved CARE transactions, whenever an MCIIm subscriber who is provided local service through services for resale, INP/NP, or unbundled Network Elements changes MCIIm PIC status.

2.1.7.2 Sprint shall support and implement new Transaction Code Status Indicators ("TCSIs") defined by OBF in support of local resale to enable MCIIm to provide seamless subscriber service.

2.1.7.2.1 Sprint shall implement TCSIs used in conjunction with the new Local Service Provider ("LSP") Identification Code for handling Account Maintenance, Subscriber Service, and Trouble



Administration issues. These TCSIs include 4001/02/05, 4201-4203, 4205, 4301, 2033, 2233, 3148, 3149, and others as OBF may define.

2.1.7.2.2 In addition, Sprint shall implement TCSIs used in conjunction with the new Ported Telephone Number field to link "shadow" and ported telephone numbers in support of Interim Number Portability. These TCSIs include 2231, 3150, and others as OBF may define.

2.1.7.3 Sprint shall provide to MCIIm the Local Service Provider ("LSP") ID on purchased lists of MCIIm PIC'd and non-PIC'd subscribers.

2.1.7.4 Sprint shall provide the Ported Telephone Number ("PTN") on purchased CARE lists of MCIIm PIC'd and non-MCIIm PIC'd subscribers.

#### **2.1.8 Number Administration/Number Reservations**

2.1.8.1 Sprint shall provide testing and loading of MCIIm's NXX on the same basis as Sprint provides itself or its Affiliates. Further, Sprint shall provide MCIIm with access to abbreviated dialing codes, access arrangements for 555 line numbers, and the ability to obtain telephone numbers, including vanity numbers, while a subscriber is on the phone with MCIIm. Sprint shall provide the same range of number choices to MCIIm, including choice of exchange number, as Sprint provides its own subscribers. Reservation and aging of numbers shall remain Sprint's responsibility.

2.1.8.2 Where mutually agreed, which agreement shall not be unreasonably withheld, the Parties will implement LERG reassignment for particular NXX Codes.

2.1.8.3 In conjunction with an order for service, Sprint shall accept MCIIm orders for vanity numbers and blocks of numbers for use with complex services including, but not limited to, DID, CENTREX, and hunting arrangements, as requested by MCIIm.

2.1.8.4 For simple services number reservations, Sprint shall provide real-time confirmation of the number reservation. For number reservations associated with

complex services, Sprint shall provide confirmation of the number reservation within twenty-four (24) hours of MCI's request. Consistent with the manner in which Sprint provides numbers to its own subscribers, no telephone number assignment is guaranteed until service has been installed.

## **2.2 Service Order Process Requirements**

### **2.2.1 OBF Compliance**

2.2.1.1 In accordance with OBF standards, as may be amended by OBF from time to time, Sprint and MCI shall follow the OBF-developed ordering and provisioning process standards. These processes may include pre-order service inquiry, pre-order service inquiry response, firm order, acknowledgment/rejection, firm order confirmation, delay notification, and completion notification. Pending finalization of applicable OBF standards, the Parties agree to negotiate in good faith interim standards relying upon partially completed OBF standards. Sprint agrees to work cooperatively to implement future OBF-developed processes related to ordering and provisioning.

### **2.2.2 Service Migrations and New Subscriber Additions**

2.2.2.1 For resale services, Sprint shall not require a disconnect order from a subscriber, another local service provider, or any other entity to process an MCI order to establish MCI local service and/or migrate a subscriber to MCI local service.

2.2.2.2 For resale services, Sprint shall not disconnect any subscriber service or existing features at any time during the migration of that subscriber to MCI service without prior MCI agreement.

2.2.2.3 For services provided through unbundled Network Elements, Sprint shall recognize MCI as an agent, in accordance with OBF-developed processes, for the subscriber in coordinating the disconnection of services provided by another CLEC or Sprint. In addition, Sprint and MCI will work cooperatively to ensure that a subscriber is not disconnected from service during these conversions.

2.2.2.4 Unless otherwise directed by MCI and when technically capable, when MCI orders resale services or Network Elements all trunk or telephone numbers currently associated with existing services shall be retained without loss of feature capability and without loss of associated ancillary services including, but not limited to, Directory Assistance and 911/E911 capability.

2.2.2.5 For subscriber conversions requiring coordinated cut-over activities, on a per order basis, Sprint and MCI will agree on a scheduled conversion time, which will be a designated two-hour time period within a designated date.

2.2.2.5.1 Sprint will coordinate activities of all Sprint work groups involved with the conversion. This coordination will include, but not be limited to, work centers charged with manual cross-connects, electronic cross-connect mapping, and Switch translations (including, but not limited to, implementation of interim local number portability translations).

2.2.2.5.2 Sprint will notify MCI when conversion is complete.

2.2.2.5.3 End user service interruptions shall be held to a minimum, and in any event shall not exceed the time Sprint experiences when performing such work for its own subscribers.

### **2.2.3 Intercept Treatment and Transfer of Service Announcements**

2.2.3.1 Sprint shall provide unbranded intercept treatment and transfer of service announcements to MCI's subscribers. Sprint shall provide such treatment and transfer of service announcement in accordance with local tariffs and as provided to similarly situated Sprint subscribers for all service disconnects, suspensions, or transfers.

### **2.2.4 Desired Due Date ("DDD")**

2.2.4.1 MCI shall specify on each order the Desired Due Date ("DDD"). Sprint shall not complete the order prior to the DDD, unless authorized by MCI.

2.2.4.2 If the DDD falls after the agreed upon standard order completion interval, Sprint shall use the DDD as the order due date.

2.2.4.3 Sprint shall supply MCIIm with due date intervals to be used by MCIIm personnel to determine service installation dates.

2.2.4.4 Subsequent to an initial order submission, MCIIm may request a new/revised due date that is earlier than the minimum defined interval.

2.2.4.5 Any special or preferred scheduling options available, internally or externally to Sprint, for ordering and provisioning services shall also be available to MCIIm.

2.2.4.6 Sprint shall use best efforts to complete orders by the MCIIm requested DDD within agreed upon intervals and performance measures.

## **2.2.5 Subscriber Premises Inspections and Installations**

2.2.5.1 MCIIm shall perform or contract for all MCIIm's needs assessments, including equipment and installation requirements, at the subscriber premises.

2.2.5.2 Sprint shall provide MCIIm with the ability to schedule subscriber premises installations. The Parties shall mutually agree on an interim process to provide this functionality during the implementation planning process. The Parties shall make a reasonable effort to complete this process within ninety (90) days after the Effective Date.

2.2.5.3 [INTENTIONALLY LEFT BLANK]

## **2.2.6 Firm Order Confirmation ("FOC")**

2.2.6.1 Sprint shall provide to MCIIm a Firm Order Confirmation ("FOC") for each MCIIm order. The FOC shall contain the appropriate data elements as defined by the OBF standards.

2.2.6.2 For a revised FOC, Sprint shall provide standard detail as defined by the OBF standards.

2.2.6.3 Sprint shall provide to MCIIm the date that service is scheduled to be initiated.

## **2.2.7 Order Rejections**

2.2.7.1 Sprint shall reject and return to MCIIm any order that Sprint cannot provision, due to technical reasons, missing information, or jeopardy conditions in accordance with Performance Measurements in Section 2.5. When an order is rejected, Sprint shall, in its reject notification, specifically describe all of the reasons for which the order was rejected. Sprint shall not reject any orders on account of the DDD.

2.2.7.2 Sprint agrees to accept from MCIIm verbal administrative order errors. Sprint shall immediately inform MCIIm by telephone of any minor issues which can be handled over the phone.

2.2.7.3 If any portion of a service order, as submitted by MCIIm, is not correct, Sprint shall make all reasonable attempts to complete any portion of the work that can be completed, while awaiting correction of error conditions by MCIIm.

## **2.2.8 Service Order Changes**

2.2.8.1 If an installation or other MCIIm-ordered work requires a change from the original MCIIm service order in any manner, Sprint shall call MCIIm in advance of performing the installation or other work to obtain authorization. Sprint shall then provide MCIIm an estimate of additional labor hours and/or materials. After all installation or other work is completed, Sprint shall promptly notify MCIIm of costs.

2.2.8.1.1 If additional work is completed on a service order, as approved by MCIIm, the cost of the additional work must be reported promptly to MCIIm.

2.2.8.1.2 If a service order is partially completed, notification must identify the work that was done and work remaining to be completed.

2.2.8.2 If an MCIIm subscriber requests a service change at the time of installation or other work being performed by Sprint on behalf of MCIIm, Sprint, while at the subscriber

premises, shall direct the MCI subscriber to contact MCI so as to avoid unnecessary delays in service activation should a Sprint representative leave subscriber premises.

### **2.2.9 Jeopardy Situations**

2.2.9.1 Sprint shall provide to MCI notification of any jeopardy situations prior to the committed due date, missed appointments and any other delay or problem in completing work specified on MCI's service order as detailed on the FOC, in accordance with agreed upon performance measurements.

### **2.2.10 Cooperative Testing**

#### **2.2.10.1 Network Testing**

2.2.10.1.1 Sprint shall perform all its standard pre-service testing prior to the completion of the order.

2.2.10.1.2 Within twenty-four (24) hours of MCI's request for scheduled cooperative maintenance testing, Sprint shall perform said testing with MCI (including trouble shooting to isolate any problems) to test Network Elements purchased by MCI in order to identify any problems.

#### **2.2.10.2 Systems and Process Testing**

2.2.10.2.1 Sprint shall cooperate with MCI upon request to ensure that all operational interfaces and processes are in place and functioning properly and efficiently, as mutually agreed by the Parties. Testing shall simulate actual operational procedures and systems interfaces to the greatest extent possible. Further, the testing shall not be limited by either geography or time frame, unless otherwise mutually agreed by the Parties. MCI may request cooperative testing to ensure service performance, reliability, and subscriber serviceability.

### **2.2.11 Service Suspensions/Restorations**

2.2.11.1 Upon MCI's request through an industry standard ("OBF") suspend/restore order, or mutually agreed upon

interim procedure, Sprint shall suspend or restore the functionality of any Network Element, feature, function, or resale service to which suspend/restore is applicable. Sprint shall provide restoration priority on a per Network Element or Combination basis in a manner that conforms with any applicable regulatory rules and regulations or government requirements.

#### **2.2.12 Disconnects**

2.2.12.1 Sprint, as underlying service provider, shall provide to MCIIm information notifying MCIIm of any services disconnected from MCIIm following notification guidelines as adopted by OBF. In the interim, such notices will be provided for all such disconnects on a daily basis in a format as mutually agreed.

#### **2.2.13 Order Completion Notification**

2.2.13.1 Upon completion of the requests submitted by MCIIm, Sprint shall provide to MCIIm a completion notification in an industry standard (*i.e.*, OBF) or in a mutually agreed format. The completion notification shall include detail of the work performed, to the extent this is defined within OBF guidelines, and in an interim method until such standards are defined.

#### **2.2.14 Fulfillment Process**

2.2.14.1 MCIIm shall conduct all activities associated with the account fulfillment process for all MCIIm subscribers.

#### **2.2.15 Specific Unbundling Requirements**

2.2.15.1 MCIIm may order and Sprint shall provision unbundled Network Elements either individually or in any mutually agreed Combination on a single order. Network Elements ordered as combined shall be provisioned as combined by Sprint unless MCIIm specifies that the Network Elements ordered in Combination be provisioned separately.

2.2.15.2 Prior to providing service in a specific geographic area or when MCIIm requires a change of network configuration, MCIIm may elect to place an order with Sprint requiring Sprint to prepare Network Elements and Switch

translations in advance of orders for such Network Elements from MCIIm.

2.2.15.3 When MCIIm orders Network Elements that are currently connected, Sprint shall ensure such Network Elements remain connected and functional without any disconnection or disruption. This shall be known as contiguous network connection of Network Elements. There shall be no charge for such pre-existing connections.

2.2.15.4 Combinations of contiguous Network Elements shall be available to be ordered: (i) on a case-by-case basis for those Network Elements that are subscriber-specific; or (ii) on a common-use basis for those Network Elements that are shared by multiple subscribers.

2.2.15.5 Network Elements shall be identified and ordered by MCIIm so that they can be provisioned together. MCIIm may specify the functionality of a Combination without the need to specify the configuration of the individual Network Elements needed to provide that functionality.

2.2.15.6 When ordering a Combination, MCIIm shall have the option of ordering all features, functions and capabilities of each Network Element.

2.2.15.7 When MCIIm orders Network Elements, Sprint shall provision all requested features, functions, and capabilities of the Network Elements which include, but are not limited to:

2.2.15.7.1 The basic switching function of connecting lines to lines, lines to trunks, trunks to lines, and trunks to trunks, as well as the same basic capabilities made available to Sprint's subscribers, such as telephone numbers, white page listing, and dial tone; and

2.2.15.7.2 All other features that the Switch is capable of providing including, but not limited to, custom calling, custom local area signaling service features, and CENTREX, as well as any Technically Feasible customized routing functions provided by the Switch.



2.2.15.8 When MCI orders Network Elements, Sprint shall provide technical assistance to ensure compatibility between elements.

2.2.15.9 Each order for Network Elements will contain administration, bill, contact, and subscriber information, as defined by the OBF.

## **2.3 Systems Interfaces and Information Exchanges**

### **2.3.1 General Requirements**

2.3.1.1 Sprint shall provide to MCI a real-time, electronic interface(s) for transferring and receiving information and executing transactions for all business functions directly or indirectly related to service ordering and provisioning of Network Elements, Network Element Combinations, features, functions, and Telecommunications Services, as specified in Exhibit A of this Attachment. The interface(s) shall be developed/designed for the transmission of data from MCI to Sprint, and from Sprint to MCI. Detailed systems requirements for specific electronic interface(s) shall be capable of supporting all of the steps in the OBF-developed ordering and provisioning process no later than July 1, 1997. These steps may include pre-order service inquiry, pre-order service inquiry response, firm order acknowledgment/rejection, firm order confirmation, delay notification, and completion notification. For any steps not yet defined by the OBF, the Parties shall mutually agree to interim methods and formats.

2.3.1.1.1 Until such standards are completed, Sprint and MCI agree to use an interim, mutually agreed upon order format and interface which will be defined and negotiated between the Parties no later than forty-five (45) days after the Effective Date of this Agreement, or as mutually agreed by the Parties.

2.3.1.1.2 Both Parties agree to implement, in an interim, manual mode, existing OBF-developed ordering and provisioning standards by January 1, 1997. Sprint shall implement future standards in a time frame agreeable to the industry, or as negotiated by the Parties.

2.3.1.2 Sprint interfaces shall provide MCIIm with the same process and system capabilities that exist for similarly-situated Sprint subscribers.

2.3.1.3 Interim interfaces or processes may be modified, if so agreed by MCIIm and Sprint, during the interim period.

2.3.1.4 Until the real-time, electronic interface is available, Sprint agrees that the Local Carrier Service Center ("LCSC") or similar function will accept MCIIm orders. Orders will be transmitted to the LCSC via an interface or method agreed upon by MCIIm and Sprint.

### **2.3.2 Ordering and Provisioning for Resale Services**

2.3.2.1 Sprint shall provide to MCIIm a list of all IntraLATA and InterLATA carriers available for subscriber selection on a Central Office level.

2.3.2.2 Upon request, Sprint shall provide to MCIIm a listing at the street address level of the service coverage area of each Switch CLLI.

2.3.2.3 Unless prohibited by law, rule or regulation, for any MCIIm subscriber or a subscriber in the process of converting to MCIIm, Sprint shall provide MCIIm with access to Customer Proprietary Network Information ("CPNI") without requiring MCIIm to produce a signed Letter of Agency ("LOA"), based on MCIIm's blanket representation that a subscriber has authorized MCIIm to obtain such CPNI.

2.3.2.3.1 Information shall be in an industry defined format, or as mutually agreed by the Parties. Sprint shall provide to MCIIm an electronic interface to Sprint subscriber information systems in the time frame specified in this Attachment VIII, or as otherwise mutually agreed. Such systems will allow MCIIm to obtain the subscriber profile, including subscriber name, billing and service addresses, billed telephone number(s), and identification of features and services on the subscriber accounts.

2.3.2.3.1.1 Until access is available via an electronic interface, Sprint agrees to provide subscriber profile information in a mutually

agreed interim manner and format, in accordance with Subsection 2.3.1.1.1 to facilitate the service order process.

2.3.2.3.2 The preordering electronic interface includes the provisioning of CPNI from Sprint to MCI. Each Party agrees that it will request end user CPNI only when the end user has specifically given permission to receive CPNI. Each Party further agrees that it will conform to FCC and/or state regulations regarding the provisioning of CPNI between the Parties and the use of CPNI by the requesting Party, and in particular that such Party will conform to the FCC rules regarding provisioning and use of CPNI applicable to interexchange carriers (IXCs) until the FCC adopts such rules specifically applicable to local exchange carriers (LECs).

2.3.2.3.3 Each Party will maintain appropriate documentation of end user permission supporting such Party's request for CPNI, including letters of authorization (LOAs) where received.

2.3.2.3.4 The Party disclosing CPNI may at any time require the Party requesting CPNI to provide copies of the evidence of end-user permission supporting any request for CPNI, if and to the extent that the first Party has reason to believe, in good faith, that the other Party may have requested CPNI without appropriate end-user permission. (By way of example and not of limitation, the Parties acknowledge that such reason would exist in the case of an end-user complaint reflecting an unauthorized local service change). The Party requested to provide evidence of end-user permission will provide it to the other Party within 5 business days of its receipt of the request.

2.3.2.3.5 If a Party is not able to provide evidence of end-user permission for 95% assuming a minimum of 50 applicable CPNI request pursuant to 2.3.2.3.4 above, the other Party may give notice to such Party that it is in breach of this Agreement. The Party so notified shall have 30 days or longer as the Parties may agree to remedy the discrepancy in its

procedures that resulted in the breach (or such longer period as the Parties may agree, such agreements not to be unreasonably withheld).

2.3.2.3.6 In the event that MCIIm does not remedy a discrepancy described in paragraph 2.3.2.3.5 within the period specified in that paragraph, Sprint may, subject to paragraph 2.3.2.3.9, disconnect the preordering electronic interface between the Parties. Prior to any such termination Sprint will give reasonable advance notice to MCIIm of its intent to terminate the interface, and will provide MCIIm with Sprint's manual interim systems and procedures.

2.3.2.3.7 In the event that Sprint has disconnected the preordering electronic interface to MCIIm pursuant to the preceding paragraph, Sprint will promptly review and accept or reject evidence provided by MCIIm of any remedy effected by MCIIm, and will promptly reconnect such preordering electronic interface upon Sprint's review and acceptance of such evidence.

2.3.2.3.8 Subject to Paragraph 2.3.2.3.9, in the event that Sprint has rightfully terminated the preordering electronic interface to MCIIm three or more times within any rolling 24-month period due to breach by MCIIm, Sprint may permanently disconnect the preordering electronic interface.

2.3.2.3.9 In the event that the Parties disagree regarding the adequacy of the evidence of end-user permission supplied by one Party to the other or any other or any other matters within this section 2.3.2.3, either Party may immediately initiate the Dispute Resolution Procedures in accordance with Section 23 of Part A of this Agreement. Sprint will not disconnect the preordering electronic interface during the dispute resolution process.

2.3.2.4 Sprint shall provide to MCIIm a list of all tariffed Telecommunications Services features and functions, including new services, trial offers, and promotions, in accordance with FCC rules in a mutually agreed time frame and shall provide prompt updates to such list as new

features and functions become available. Such detail shall also provide definitions and explanations of the features and functions available.

2.3.2.5 Upon MCI's request, Sprint shall provide to MCI, as soon as practicable, a list of all current service offerings by Switch location, which are Technically Feasible and available.

2.3.2.6 When available per electronic interface implementation plan, Sprint shall provide to MCI a real-time, electronic interface to Sprint information systems to allow MCI to assign telephone number(s) (if the subscriber does not already have a telephone number or requests a change of telephone number), as provided to similarly-situated Sprint subscribers.

2.3.2.7 When available per electronic interface implementation plan, Sprint shall provide to MCI a real-time, electronic interface to schedule dispatch and installation appointments, as provided to similarly-situated Sprint subscribers.

2.3.2.8 When available per electronic interface implementation plan, Sprint shall provide to MCI a real-time, electronic interface to Sprint subscriber information systems which will allow MCI to determine if a service call is needed to install the line or service, as provided to similarly-situated Sprint subscribers.

2.3.2.9 When available per electronic interface implementation plan, Sprint shall provide to MCI a real-time, electronic interface to Sprint information systems which will allow MCI to provide service availability dates, as provided to similarly-situated Sprint subscribers.

2.3.2.10 When available per electronic interface implementation plan, Sprint shall provide to MCI a real-time, electronic interface which transmits status information on service orders, as provided to similarly-situated Sprint subscribers. Until real-time electronic interface is available, Sprint agrees that Sprint will provide proactive status on service orders at the following critical intervals: acknowledgment, firm order confirmation, and completion according to interim procedures to be mutually developed.

### **2.3.3 Ordering and Provisioning for Unbundling**

2.3.3.1 Sprint shall provide to MCIIm as soon as practicable a listing of all technically available functionalities for Network Elements.

2.3.3.2 Sprint shall provide to MCIIm upon request all engineering design and layout information for Network Elements where applicable.

2.3.3.3 When available per the electronic interface implementation plan, Sprint shall provide to MCIIm a real-time, electronic interface which will allow MCIIm to determine service due date intervals, schedule appointments, and adjust pending order due dates as provided to similarly-situated Sprint subscribers.

2.3.3.4 To the extent Sprint has such information, Sprint shall provide to MCIIm upon request advance information of the details and requirements for planning and implementation of NPA splits at least six (6) months prior to implementation of the split.

2.3.3.5 Sprint shall provide to MCIIm information on charges associated with special construction. Until real-time, electronic interface is available, Sprint agrees that Sprint will promptly notify MCIIm of any charges associated with necessary construction.

2.3.3.6 Sprint shall provide MCIIm with results from routine mechanized loop tests for those instances when Sprint provides Local Switching and MCIIm provides the Loop. Results of any non-routine testing requested by MCIIm shall be provided at MCIIm's expense.

## **2.4 Standards**

### **2.4.1 General Requirements**

2.4.1.1 MCIIm and Sprint shall agree upon the appropriate ordering and provisioning codes to be used for Network Elements. These codes shall apply to all aspects of the unbundling of that element or Combination of elements and shall be known as data elements as defined by the Telecommunications Industry Forum Electronic Data



Interchange Service Order Subcommittee ("TCIF-EDI-SOSC").

## **2.5 Performance Measurements and Reporting**

### **2.5.1 Cycle Time Measurements**

2.5.1.1 Excepting expedited due date requests, the following order intervals shall constitute the basis for measuring Sprint service order performance under this Agreement. MCI and Sprint may agree to modify such measurements from time to time.

2.5.1.2 Sprint shall provide and acknowledge each and every MCI service order within eight (8) working hours of receipt by Sprint.

2.5.1.3 Sprint shall process MCI service orders and provide either Firm Order Confirmation ("FOC") of a correct service order or notification of a rejected order and the detail of the errors contained within any data element(s) fields contained in such order, within eight (8) working hours of receipt of Local Service Request ("LSR") from MCI.

2.5.1.4 Sprint shall complete any Suspend/Block/ Restore order as required by Commission regulation or no more than eight (8) working hours after receipt by Sprint.

2.5.1.5 When MCI specifies a DDD that is greater than the standard intervals defined in this Agreement, Sprint shall complete ordering and provisioning activities no earlier than that date.

2.5.1.6 For expedited due date requests, Sprint shall confirm to MCI within eight (8) business hours after Sprint receipt of such request from MCI whether Sprint can complete an initially-submitted order within the expedited interval requested by MCI. Confirmation may be provided by Sprint via a telephone call with follow-up confirmation to be provided by Sprint according to normal procedures and measurement intervals.

2.5.1.7 Subsequent to an order which has been initially submitted by MCI, MCI may require a new/revised due date that is earlier than the minimum defined interval.



2.5.1.7.1 For such requests, Sprint shall confirm to MCIIm within eight (8) business hours after Sprint receipt of the revised due date request from MCIIm whether Sprint can complete the order within the expedited interval requested by MCIIm. Confirmation may be provided by Sprint via a telephone call with follow-up confirmation to be provided by Sprint according to normal procedures and measurement intervals.

2.5.1.8 Cycle time intervals for ordering and provisioning of all unbundled Network Elements, where facilities are available, shall be provided by Sprint to MCIIm as part of the Implementation Plan in Part A Section 34. In the event an order is rejected for any reason agreed upon by Sprint and MCIIm, the associated interval will restart when MCIIm resubmits a correct order to Sprint.

## **2.5.2 Quality Measurements**

2.5.2.1 Sprint provisioning functions performed for MCIIm shall be determined by the Implementation Team as described in Part A Section 34.

## **Section 3. Connectivity Billing and Recording**

This Section 3 describes the requirements for each Party to bill and record all charges the other Party incurs for purchasing services under this Agreement.

### **3.1 Procedures**

3.1.1 Sprint shall comply with various industry, OBF, and other standards referred to throughout this Agreement. Sprint and MCIIm will review any changes to industry standards and will mutually agree to the interpretation of these standards before they are implemented by Sprint.

3.1.2 Sprint shall record, where Technically Feasible, and bill in accordance with this Agreement those charges MCIIm incurs as a result of MCIIm purchasing from Sprint services as set forth in this Agreement (hereinafter "connectivity charges").

3.1.3 Sprint shall implement BOS 28 during the expected implementation window of September 1, 1997, through December 31, 1997, if Technically Feasible. Thereafter, Sprint shall format

each bill for connectivity charges (hereinafter "connectivity bill") in accordance with the CABS or SECAB standard.

3.1.3.1 Subsequent BOS releases shall be implemented within the industry determined implementation windows or other mutually agreed time frames.

3.1.4 Each service purchased by MCI shall be assigned a separate and unique billing code in the form agreed to by the Parties and such code shall be provided to MCI on each connectivity bill in which charges for such services appear.

3.1.4.1 Each such billing code shall enable MCI to identify the service as ordered by MCI.

3.1.5 Each connectivity bill shall set forth the quantity and description of each such service provided and billed to MCI. All connectivity charges billed to MCI shall indicate the state from which such charges were incurred.

3.1.6 Sprint shall bill MCI for each service supplied by Sprint to MCI pursuant to this Agreement at the rates set forth in this Agreement.

3.1.7 Sprint shall bill MCI for the connectivity charges incurred; provided that, for those usage based connectivity charges where actual charge information is not determinable by Sprint because the jurisdiction (*i.e.*, interstate, interstate/ InterLATA, intrastate, intrastate/IntraLATA, local) of the traffic is unidentifiable, or for other reasons, the Parties shall jointly develop a process to determine the appropriate charges.

3.1.8 Measurement of usage based connectivity charges shall be in actual conversation seconds. The total conversation seconds per chargeable traffic types shall be totaled for the entire monthly bill cycle and then rounded to the next whole minute.

3.1.9 Sprint shall provide to MCI at no additional charge a single point of contact for interconnection and Network Elements at Sprint's National Access Service Center ("NASC"), and for resale at Sprint's IPOC to handle any connectivity billing questions or problems that may arise during the implementation and performance of the terms and conditions of this Agreement.

3.1.10 Sprint shall provide a single point of contact at each Sprint data center for handling of any data exchange questions or

problems that may arise during the implementation and performance of the terms and conditions of this Agreement.

3.1.11 As soon as possible after completion of this Agreement, each Party shall provide the other Party written notice of which form of the monthly connectivity bill is to be deemed the official bill to assist the Parties in resolving any conflicts that may arise between the official bill and another form of bill received via a different media which purportedly contain the same charges as are on the official bill.

3.1.12 If either Party requests an additional copy(ies) of a bill, such Party shall pay the other Party a reasonable fee per additional bill copy, unless such copy was requested due to errors, omissions, or corrections or the failure of the transmission to comply with the specifications set forth in this Agreement.

3.1.13 When sending connectivity bills via electronic transmission, to avoid transmission failures or the receipt of connectivity billing information that cannot be processed, MCI shall provide Sprint process specifications. Sprint shall comply with MCI's processing specifications when Sprint transmits connectivity billing data to MCI. MCI shall provide to Sprint notice if a connectivity billing transmission is received that does not meet MCI's specifications or that such Party cannot process. Such transmission shall be corrected and resubmitted to MCI, at Sprint's sole expense, in a form that can be processed. The payment due date for such resubmitted transmissions shall be thirty-five (35) days when interim, non-industry standard billing is employed and thirty (30) days when permanent, industry standard billing is employed from the date that the transmission is received in a form that can be processed and that meets the specifications set forth in this Attachment.

3.1.14 Sprint shall deliver to a location specified by MCI, billing information via Network Data Mover ("Connect:Direct"), magnetic tape or paper, as agreed to by MCI and Sprint. In the event of an emergency, system failure or other such condition which prevents Sprint from transmitting via Connect:Direct, Sprint shall notify MCI of such difficulties within twelve (12) hours of detection. Sprint shall deliver to a location specified by MCI billing information via magnetic tape or paper, as agreed to by MCI and Sprint. The Parties acknowledge that all tapes transmitted to the other Party via U.S. Mail or overnight delivery and which contain connectivity billing data shall not be returned to the sending Party.

3.1.15 Subject to the terms of this Agreement, including without limitation Sections 3.1.16 and 3.1.18 of this Attachment VIII, MCI shall pay Sprint within forty-five (45) calendar days from the bill date when interim, non-industry standard billing is employed, and thirty (30) calendar days from the receipt of the bill when permanent, industry standard billing is employed. If the payment due date is a Saturday, Sunday or has been designated a bank holiday payment shall be made the next business day.

3.1.16 Billed amounts which are being investigated, queried, or for which claims have or may be filed are not due for payment until such investigations, claims or queries have been fully resolved by both MCI and Sprint.

3.1.17 Sprint will assess late payment charges to MCI in accordance with the applicable tariff, if any. If there is no applicable tariffed late payment charges then Sprint will assess late payment charges equal to the lesser of 1.5% per month of the balance due or the maximum allowed by law, until the amount due including late payment charges is paid in full.

3.1.17.1 Upon five (5) business days notice by Sprint to MCI, Sprint may not accept any new or amended orders for Telecommunications Services, Unbundled Network Elements, Interconnection or other services under the terms of this Agreement from MCI while any past due, undisputed charges remain unpaid.

### **3.1.18 Bill Reconciliation**

3.1.18.1 Each Party agrees to notify the other Party upon the discovery of a billing discrepancy "Notice of Discrepancy".

3.1.18.2 In the event of such Notice of Discrepancy, the Parties shall endeavor to resolve the discrepancy within sixty (60) calendar days' notification using normal business procedures. If the discrepancy is disputed, resolution of such dispute is expected to occur at the first level of management resulting in a recommendation for settlement of the dispute and closure of a specific billing period.

3.1.18.3 If the dispute is not resolved within the allotted time frame, the following resolution procedures shall begin:

3.1.18.3.1 If the dispute is not resolved within sixty (60) days of the notice of discrepancy, the dispute shall be escalated to the second level of management for resolution.

3.1.18.3.2 If the dispute is not resolved within ninety (90) days of notice of discrepancy, the dispute shall be escalated to the third level of management for resolution.

3.1.18.3.3 If the dispute is not resolved within one hundred and twenty (120) days of the notice of discrepancy, the dispute may be referred to the Commission for resolution by MCIIm, or upon the written request of Sprint within such one hundred and twenty (120) day period, may be resolved pursuant to Section 23 (Dispute Resolution Procedures) of Part A of this Agreement.

3.1.18.4 If MCIIm disputes connectivity charges and the dispute is resolved in favor of MCIIm, Sprint shall credit the Connectivity Bill of MCIIm for the amount of the disputed charges.

3.1.19 Sprint shall reimburse MCIIm for incorrect Connectivity Billing charges including, without limitation, overcharges, services ordered or requested but not delivered, interrupted services, services of poor quality, and installation problems if caused by Sprint. Such reimbursements shall be set forth in the appropriate section of the Connectivity Bill pursuant to CABS, or SECAB standards.

3.1.20 The Parties agree to record call information for Local Interconnection in accordance with this Subsection 3.1. To the extent Technically Feasible, each Party shall record all call detail information associated with every call originated or terminated to the other Party's local exchange subscriber. The Parties agree that they shall record call detail information if Technically Feasible even if such records or call detail information has not been recorded in the past. These records shall be provided at a Party's request and shall be formatted pursuant to Bellcore's EMR standards and the terms and conditions of this Agreement. These records shall be transmitted to the other Party daily in EMR format via Connect:Direct. Sprint and MCIIm agree that they shall retain, at each Party's sole expense, copies of all EMR records transmitted

to the other Party for at least forty-five (45) calendar days after transmission to the other Party.

3.1.21 When MCIIm collocates with Sprint in Sprint's facility as described in this Agreement, capital expenditures (*e.g.*, costs associated with building the "cage") shall not be included in the connectivity bill provided to MCIIm pursuant to this Attachment VIII. All such capital expenses shall be given a unique BAN and invoice number. All invoices for capital expenses shall be sent to the location specified by MCIIm for payment. All other non-capital recurring Collocation expenses shall be billed to MCIIm in accordance with this Agreement. (The CABS Billing Output Specifications ("BOS") documents provide the guidelines on how to bill the connectivity charges associated with Collocation.) The bill label for such Collocation charges shall be entitled "Expanded Interconnection Service." The bill label for non-capital recurring Collocation expenses shall be entitled "Collocation."

3.1.22 Sprint shall be responsible for billing and collecting charges from IXCs for access related to interexchange calls generated by resale subscribers.

3.1.23 When MCIIm owns the end office, Sprint shall not bill RIC to either MCIIm or other IXCs.

3.1.24 Sprints and MCIIm shall determine the appropriate and mutually agreeable form of administrative billing between billing carriers.

3.1.25 Sprint shall establish a switched access meet point billing arrangement with MCIIm. This arrangement will include tandem routed IXC calls and IXC calls routed through a line that is ported via Remote Call Forward ("RCF") or FLEX DID from Sprint to MCIIm.

3.1.25.1 MCIIm will bill for carrier common line, local switching, RIC, and its portion of the transport charges for tandem routed IXC calls. For lines that are ported from Sprint to MCIIm, Sprint will bill only transport charges. MCIIm will bill for all other applicable access charges.

3.1.25.2 Sprint and MCIIm will provide all necessary switched access records to each other for access billing.

### **3.2 Information Exchange and Interfaces**

3.2.1 Sprint shall provide MCIIm a monthly connectivity bill that includes all connectivity charges incurred by and credits and/or adjustments due to MCIIm for those services ordered, established, utilized, discontinued or performed pursuant to this Agreement. Sprint shall issue one (1) bill per month, on the first day of the month and the billing cycle shall be on a calendar basis. Each connectivity bill provided by Sprint to MCIIm shall include:

3.2.1.1 All non-usage sensitive charges incurred for the period beginning with the day after the current bill date and extending to the day before the next bill date;

3.2.1.2 Any known unbilled non-usage sensitive charges for prior periods;

3.2.1.3 Unbilled usage sensitive charges for the period beginning with the last bill date and extending up to, but not including, the current bill date;

3.2.1.4 Any known unbilled usage sensitive charges for prior periods; and

3.2.1.5 Any known unbilled adjustments.

3.2.2 The bill date (defined as the date the bill was prepared) must be present on each bill transmitted by Sprint to MCIIm, must be a valid calendar date, and not more than ninety (90) days old. Connectivity bills shall not be rendered for any connectivity charges which are incurred under this Agreement on or before ninety (90) days preceding the bill date, except as otherwise permitted by law.

3.2.3 On each bill where "Jurisdiction" is identified, local and local toll charges shall be identified as "Local" and not as interstate, interstate/InterLATA, intrastate, or intrastate/IntraLATA. Sprint shall provide from and through dates for charges rendered on all connectivity bills.

3.2.4 Sprint shall separately identify business charges from residence charges, as appropriate, and shall assign a specific adjustment or reference number provided by MCIIm to each adjustment and credit included on the connectivity bill.

3.2.5 Sprint and MCIIm shall issue all connectivity bills in accordance with the terms and conditions set forth in this Section

3. On connectivity bills that Sprint renders to MCIIm, BANs shall be thirteen (13) character alpha/numeric and there shall only be one (1) BAN per LATA. The bill date shall be the same day, month-to-month. Each Party shall provide the other Party with at least thirty (30) calendar days written notice prior to changing, adding or deleting a BAN. The Parties shall provide one (1) connectivity billing invoice associated with each BAN. Each invoice must contain an invoice number (which will vary from month-to-month). On each bill associated with a BAN, the appropriate invoice number and the charges contained on such invoice must be reflected. All connectivity bills must be received by the other Party no later than ten (10) calendar days from bill date and at least thirty (30) calendar days prior to the payment due date (as described in this Attachment), whichever is earlier. Any connectivity bill received on a Saturday, a Sunday or a day designated as a bank holiday will be deemed received the next business day. If either Party fails to receive connectivity billing data and information within the time period specified above, the payment due date will be extended by the number of days that such receipt has been delayed.

3.2.6 Sprint shall issue all connectivity bills containing such billing data and information in accordance with the most current version of CABS/SECABS published by Bellcore, or its successor, or such later versions as are adopted by Bellcore, or its successor, as agreed to by the Parties pursuant to Section 3.1.1 herein.

3.2.7 Sprint and MCIIm agree that each Party shall transmit connectivity billing information and data in the appropriate CABS or SECAB format electronically via Connect:Direct to the other Party at the location specified by such Party. MCIIm data centers will be responsible for originating the calls for data transmission. The Parties shall mutually agree to the technical specifications for transmission. MCIIm will supply to Sprint its RACF ID and password before the first transmission of data via Connect:Direct. Any changes to either Party's Connect:Direct Node ID must be sent to the other Party no later than thirty (30) calendar days before the changes take effect.

3.2.8 In emergency situations when tape transmittal has been used, Sprint shall adhere to the tape packaging requirements set forth in this Agreement. Where magnetic tape shipping containers are transported in freight compartments, adequate magnetic field protection shall be provided by keeping a six (6) inch distance from any magnetic field generating device (except a magnetron-tape



device). Sprint shall only use those shipping containers that contain internal insulation to prevent damage. Sprint shall clearly mark on the outside of each shipping container its name, contact and return address. Sprint shall not ship any connectivity billing tapes in tape canisters.

3.2.9 All emergency billing data transmitted via tape must be provided on a cartridge (cassette) tape and must be of high quality, conform to the Parties' record and label standards, 9-track, odd Parity, 6250 BPI group coded recording mode and extended binary-coded decimal interchange code ("EBCDIC"). Each reel of tape must be one hundred percent (100%) tested at twenty percent (20%) or better "clipping" level with full width certification and permanent error-free at final inspection. MCI reserves the right to destroy a tape that has been determined to have unrecoverable errors. MCI also reserves the right to replace a tape with one of equal or better quality.

3.2.10 Billing data tapes used in emergency circumstances shall have the following record and label standards. The data set serial number on the first header record of an IBM standard tape label also shall have the following format.

	<b>CABS BOS</b>	<b>SECAB</b>
Record length	Bytes (fixed length)	Bytes (fixed length)
Blocking factor	Records per block	Not applicable
Block size	Bytes per block	Not applicable
Labels	Standard IBM Operating System	Standard IBM Operating System

3.2.11 A single six (6) digit serial number must appear on the external (flat) surface of the tape for visual identification. This number shall also appear in the "data set serial number field" of the first header record of the IBM standard tape label. This serial number shall consist of the character "V" followed by the reporting location's four (4) digit originating company code and a numeric character chosen by the sending company. The external and internal label shall be the same. The data set name shall appear

on the flat side of the reel and also in the "dataset name field" on the first header record of the IBM standard tape label. Sprint's name, address, and contact shall appear on the flat side of the cartridge or reel.

3.2.12 Tape labels shall conform to IBM OSNS Operating System Standards contained in the IBM Standard Labels Manual. IBM standard labels are eighty (80) character records recorded in EBCDIC, odd Parity.

3.2.13 Sprint shall conform to the Standard Volume Label Format which will be prescribed by MCI.

3.2.14 Sprint shall use the IBM Standard Data Set Label Format which will be prescribed by MCI.

3.2.15 Sprint shall use test and production data set format which will be prescribed by MCI for each CABS and SECABS.

### **3.3 Standards**

3.3.1 Within thirty (30) days of the execution of this Agreement, Sprint shall send to MCI connectivity bill data in the appropriate mechanized format (*i.e.*, CABS or SECAB) for testing to ensure that bills can be processed and that bills comply with the requirements of this Attachment. After receipt of the test data from Sprint, MCI will notify Sprint if the connectivity billing transmission meets MCI's testing specifications. Sprint agrees to correct data and resend the transmission until it has met all of MCI's testing specifications. At least three (3) sets of testing data must meet MCI's testing specifications prior to Sprint sending MCI a mechanized production connectivity bill for the first time via electronic transmission or tape. Thereafter, Sprint may begin sending MCI production connectivity bills via electronic transfer on the next bill date, or within ten (10) days, whichever is later.

3.3.2 Sprint shall provide notice to MCI at least ninety (90) days prior to any change in existing formats or change to a different format. Sprint shall send to MCI connectivity bill data in the appropriate mechanized format for testing to ensure that the bills can be processed and that the bills comply with the requirements of this Attachment at least thirty (30) days prior to such change. Sprint agrees that it shall not send to MCI bill data in the new mechanized format until such bill data has met the testing specifications as set forth in this Subsection.

3.3.3 During the testing period, Sprint shall transmit to MCIIm connectivity billing data and information via paper or tape as specified by MCIIm. Test tapes shall be sent to a MCIIm-specified location.

3.3.4 Sprint agrees that if it transmits data to MCIIm in a mechanized format, Sprint shall also comply with the following specifications which are not contained in CABS or SECAB guidelines but which are necessary for MCIIm to process connectivity billing information and data:

3.3.5 The bill date shall not contain spaces or non-numeric values.

3.3.5.1 Each connectivity bill must contain at least one (1) detail record.

3.3.5.2 Any "from" date should be less than the associated "thru" date and neither date can contain spaces.

3.3.5.3 The invoice number must not have embedded spaces or low values.

3.3.6 Sprint agrees that in order to ensure the proper performance and integrity of the entire connectivity billing process, Sprint shall be responsible and accountable for transmitting to MCIIm an accurate and current bill. Sprint agrees to work with MCIIm to identify and implement control mechanisms and procedures to render a bill that accurately reflects the services ordered and used by MCIIm.

#### **3.4 Revenue Protection**

3.4.1 Sprint shall make available to MCIIm at Parity with what Sprint provides to itself, its Affiliates and other local Telecommunications Carriers all present and future fraud prevention or revenue protection features, including prevention, detection, or control functionality embedded within any of the Network Elements. These features include, but are not limited to, screening codes, information digits assigned such as information digits '29' and '70' which indicate prison and COCOT pay phone originating line types respectively, call blocking of domestic, international, 800, 888, 900, NPA-976, 700, 500 and specific line numbers, and the capability to require end user entry of an authorization code for dial tone. Sprint shall, when technically capable and consistent with the implementation schedule for OSS, additionally provide partitioned access to fraud prevention,

detection and control functionality within pertinent Operations Support Systems ("OSS") which include, but are not limited to, line information data base fraud monitoring systems, high toll notifiers, SS7 suspect traffic alerts, AMA suspect traffic alerts, *etc.* Uncollectible or unbillable revenues resulting from, but not confined to provisioning, maintenance, or signal network routing errors shall be the responsibility of the Party causing such error.

3.4.2 Uncollectible or unbillable revenues resulting from the accidental or malicious alteration of software underlying Network Elements or their subtending operational support systems by unauthorized third parties shall be the responsibility of the Party having administrative control of access to said Network Element or operational support system software to the extent the accidental or malicious alteration was caused by or resulted from negligence or intentional misconduct of the Party having administrative control.

3.4.3 Either Party shall be responsible for any uncollectible or unbillable revenues resulting from the unauthorized use of the service provider network whether that compromise is initiated by software or physical attachment to loop facilities from the main distribution frame up to and including, the network interface device, including clip-on fraud to the extent such compromise or fraud was caused or resulted from the negligence or intentional misconduct of such Party.

#### ***Section 4. Provision of Subscriber Usage Data***

This Section 4 sets forth the terms and conditions for Sprint's provision of Recorded Usage Data (as defined in this Attachment VIII) to MCI and for information exchange regarding long distance billing.

#### **4.1 Procedures**

##### **4.1.1 General**

4.1.1.1 Sprint shall comply with various industry and OBF standards referred to throughout this Agreement.

4.1.1.2 Sprint shall comply with OBF standards and the additional standards outlined in this Agreement when recording and transmitting usage data.

4.1.1.3 Sprint shall record all usage originating from MCI subscribers using service ordered by MCI, where Sprint

records and bills those same services for Sprint subscribers. Recorded Usage Data includes, but is not limited to, the following categories of information:

4.1.1.3.1 Completed calls;

4.1.1.3.2 Use of CLASS/LASS/custom features;

4.1.1.3.3. Calls to information providers reached via Sprint facilities pursuant to 4.1.1.7 and contracted by Sprint;

4.1.1.3.4 Calls to Directory Assistance where Sprint provides such service to an MCIIm subscriber;

4.1.1.3.5 Calls completed via Sprint-provided Operator Services where Sprint provides such service to MCIIm's local service subscriber. For Sprint-provided CENTREX service, station level detail records shall include complete call detail and complete timing information; and

4.1.1.3.6 Recording of completed calls which Sprint does not record for its own service offerings (e.g., flat rate free calling area service).

**4.1.1.4 Retention of Records.** Sprint shall maintain a machine readable back-up copy of the message detail provided to MCIIm for a minimum of forty-five (45) calendar days. Sprint shall provide any data back-up to MCIIm upon the request of MCIIm.

4.1.1.5 Sprint shall provide to MCIIm Recorded Usage Data for MCIIm subscribers. Sprint shall not submit other carrier local usage data as part of the MCIIm Recorded Usage Data.

4.1.1.6 Sprint shall not bill to MCIIm subscribers any recurring or non-recurring charges except where explicitly permitted to do so within a written agreement between Sprint and MCIIm.

4.1.1.7 Billing of 900 service calls shall be determined by the Implementation Team as described in Part A Section 34.

4.1.1.8 Sprint shall provide Recorded Usage Data to MCIIm billing locations as designated by MCIIm.

4.1.1.9 Sprint shall establish a Local Carrier Service Center ("LCSC") or similar function to serve as MCIIm's single point of contact to respond to MCIIm call usage, data error, and record transmission inquiries.

4.1.1.10 Sprint shall provide MCIIm with a single point of contact and remote identifiers ("IDs") for each sending location.

4.1.1.11 MCIIm shall provide a single point of contact responsible for receiving usage transmitted by Sprint and receiving usage tapes from a courier service in the event of a facility outage.

4.1.1.12 Sprint shall bill and MCIIm shall pay the charges for Recorded Usage Data. Billing and payment shall be in accordance with the applicable terms and conditions set forth in the Connectivity Billing and Recording Section of this Attachment VIII.

4.1.1.13 Without waiver of, and in addition to the Audit and Examination rights in the Section 22 (Audits and Examinations of Part A) of this Agreement, upon reasonable notice and at reasonable times MCIIm or its authorized representatives may examine Sprint's documents, systems, records and procedures which relate to the recording and transmission of the usage data to MCIIm under this Attachment.

#### **4.1.2 Charges**

4.1.2.1 Sprint shall not bill for recording or rating usage data. Sprint shall bill MCIIm for message provisioning, data transmission and/or tape charges using tariff rates, if any, or at the rates contained in Attachment I of this Agreement.

#### **4.1.3 Central Clearinghouse and Settlement**

4.1.3.1 Sprint and MCIIm shall agree upon clearinghouse and incollect/outcollect procedures.

4.1.3.2 Sprint shall settle with MCIIm for both intra-region and inter-region billing exchanges of calling card, bill-to-third

party, and collect calls under a separate arrangement to be negotiated.

#### **4.1.4 Lost Data**

**4.1.4.1 Loss of Recorded Usage Data.** MCIIm Recorded Usage Data determined to have been lost, damaged or destroyed as a result of an error or omission by Sprint in its performance of the recording function shall be recovered by Sprint at no charge to MCIIm. In the event the data cannot be recovered by Sprint, Sprint shall estimate the messages and associated revenue, with assistance from MCIIm, based upon the method described below. This method shall be applied on a consistent basis, subject to modifications agreed to by Sprint and MCIIm. This estimate shall be used to adjust amounts MCIIm owes Sprint for services Sprint provides in conjunction with the provision of Recorded Usage Data.

**4.1.4.2 Partial Loss.** Sprint shall review its daily controls to determine if data has been lost. When there has been a partial loss, actual message and minute volumes shall be reported, if possible through recovery as discussed in 4.1.4.1 above. Where actual data are not available, a full day shall be estimated for the recording entity, as outlined in the following Subsections. The amount of the partial loss is then determined by subtracting the data actually recorded for such day from the estimated total for such day.

**4.1.4.3 Complete Loss.** When Sprint is unable to recover data as discussed in 4.1.4.1 above, estimated message and minute volumes for each loss consisting of an entire AMA tape or entire data volume due to its loss prior to or during processing, lost after receipt, degaussed before processing, receipt of a blank or unreadable tape, or lost for other causes, shall be reported.

**4.1.4.4 Estimated Volumes.** From message and minute volume reports for the entity experiencing the loss, Sprint shall secure message/minute counts for the four (4) corresponding days of the weeks preceding that in which the loss occurred and compute an average of these volumes. Sprint shall apply the appropriate average revenue per message ("arpm") agreed to by MCIIm and Sprint to the estimated message volume for messages for which usage

charges apply to the MCI's subscriber or access customers to arrive at the estimated lost revenue.

4.1.4.5 If the day of loss is not a holiday but one (1) (or more) of the preceding corresponding days is a holiday, use additional preceding weeks in order to procure volumes for two (2) non-holidays in the previous two (2) weeks that correspond to the day of the week that is the day of the loss.

4.1.4.6 If the loss occurs on a weekday that is a holiday (except Christmas & Mother's Day), Sprint shall use volumes from the two (2) preceding Sundays.

4.1.4.7 If the loss occurs on Mother's Day or Christmas day, Sprint shall use volumes from that day in the preceding year multiplied by a growth rate agreed to by MCI and Sprint.

4.1.4.8 MCI may also request data be provided that has previously been successfully provided by Sprint to MCI. Sprint shall re-provide such data, if available, at MCI's expense.

#### **4.1.5 Testing, Changes and Controls**

4.1.5.1 The Recorded Usage Data, EMR format, content and transmission process shall be tested as agreed upon by MCI and Sprint pursuant to Implementation Plan as described in PART A.

4.1.5.2 **Periodic Review.** Control procedures for all usage transferred between Sprint and MCI shall require periodic review. This review may be included as part of an audit of Sprint by MCI or as part of the normal production interface management function. Breakdowns which impact the flow of usage between Sprint and MCI must be identified and jointly resolved as they occur. The resolution may include changes to control procedures, as similar problems would be avoided in the future. Any changes to control procedures would need to be mutually agreed upon by MCI and Sprint.

#### **4.1.5.7 Sprint Software Changes**

4.1.5.7.1 When Sprint plans to introduce any software changes which impact the format or content structure of the usage data feed to MCI, designated



Sprint personnel shall notify MCIIm no less than ninety (90) calendar days before such changes are implemented.

4.1.5.7.2 Sprint shall communicate the projected changes to MCIIm's single point of contact so that potential impacts on MCIIm processing can be determined.

4.1.5.7.3 MCIIm personnel shall review the impact of the change on the entire control structure and the post conversion test plan, herein. MCIIm shall negotiate any perceived problems with Sprint and shall arrange to have the data tested utilizing the modified software.

4.1.5.7.4 If it is necessary for Sprint to request changes in the schedule, content or format of usage data transmitted to MCIIm, Sprint shall notify MCIIm.

#### **4.1.5.8 MCIIm Requested Changes**

4.1.5.8.1 MCIIm may negotiate changes in the schedule, content, format of the usage data transmitted from Sprint.

4.1.5.8.2 When the negotiated changes are to be implemented, MCIIm and/or Sprint shall arrange for testing of the modified data in a post conversion test plan designed to encompass all types of changes to the usage data transferred by Sprint to MCIIm and the methods of transmission for that data.

#### **4.1.5.9 Sprint System Change Description**

4.1.5.9.1 For a Sprint system change, Sprint shall provide MCIIm with an overall description of the change, stating the objective and a brief explanation of the reasons for the change.

4.1.5.9.2 During the initial negotiations regarding the change, Sprint shall provide a list of the specific records and/or processes impacted by the change to designated MCIIm personnel.

4.1.5.9.3 Sprint shall also provide MCIIm a detailed description of the changes to be implemented. It shall include sufficient detail for designated MCIIm personnel to analyze and estimate the effects of the changes and to design tests to verify the accuracy of the implementation.

#### **4.1.5.10 Change Negotiations**

4.1.5.10.1 MCIIm shall be notified in writing of proposed change negotiations initiated by Sprint. In turn, MCIIm shall notify Sprint in writing of proposed change negotiations initiated by MCIIm.

4.1.5.10.2. After formal notification of planned changes, whether originated by Sprint or MCIIm, designated MCIIm personnel shall schedule negotiation meetings as required with designated Sprint personnel.

**4.1.5.11 Changes to controls.** MCIIm and Sprint may negotiate changes to the control structure. Sprint and MCIIm shall comply with the agreed upon changes.

#### **4.1.5.12 Verification Of Changes**

4.1.5.12.1 Based on the detailed description of changes furnished by Sprint, MCIIm and Sprint personnel shall negotiate:

4.1.5.12.1.1 The type of change(s) to be implemented;

4.1.5.12.1.2 Development of a comprehensive test plan;

4.1.5.12.1.3 Scheduling and transfer of modified data with Sprint;

4.1.5.12.1.4 Testing of modified data with the appropriate MCIIm RPC;

4.1.5.12.1.5 Processing of verified data through the MCIIm billing system with the RPC;

4.1.5.12.1.6 Review and verification of testing with appropriate MCIIm groups; and

4.1.5.12.1.7 Review of modified controls, if applicable.

#### **4.1.5.13 Introduction of Changes**

4.1.5.13.1 When all the testing requirements have been met and the results reviewed and accepted, designated MCIIm and Sprint personnel shall mutually agree on an implementation schedule.

### **4.2 Information Exchange and Interfaces**

#### **4.2.1 Core Billing Information**

**4.2.1.1 Recorded Usage Data all IntraLATA toll and local usage.** Sprint shall transmit to MCIIm unrated EMR records associated with all IntraLATA toll and local usage which it records on MCIIm's behalf, where in the case of resale Sprint records and bills such usage for itself, with the exception of "976", "N11" and alternate-billed service. Any category, group and/or record types approved in the future for Sprint shall be included if they fall within the definition of local service resale. MCIIm shall be given notification thirty (30) days prior to implementation of a new type, category and/or record.

**4.2.1.2** MCIIm and Sprint shall agree upon the types of rated EMR records that Sprint shall send to MCIIm.

**4.2.1.3 Data Delivery Schedules.** Data shall be delivered to MCIIm by Sprint daily (Monday through Friday), unless otherwise negotiated, based on Sprint's operational processes. MCIIm and/or Sprint data center holidays are excluded. Sprint and MCIIm shall exchange schedules of designated data center holidays.

#### **4.2.2 Product/Service Specific**

**4.2.2.1** Sprint shall provide a specialized service/ service provider charge record to support the special features star services, if these features are part of Sprint's offering.

### 4.2.3 Emergency Information

4.2.3.1 Sprint shall provide the transport facility for transmitting usage and billing data between Sprint location and the MCI location. Sprint shall transmit via Connect:Direct whenever possible. In the event usage transfer cannot be accommodated by Connect:Direct because of extended (one (1) business day or longer) facility outages, Sprint shall contract for a courier service to transport the data via tape.

4.2.3.2 Sprint shall comply with the following standards when emergency data is transported to MCI on tape or cartridge via a courier. The data shall be in variable block:

<b>Tape:</b>	9-track, 6250 (or 1600) BPI (bytes per inch)
<b>Cartridge:</b>	38,000 BPI (bytes per inch)
<b>LRECL:</b>	2,472 Bytes
<b>Parity:</b>	Odd
<b>Character Set:</b>	Extended Binary Coded Decimal Interchange Code ("EBCDIC")
<b>External labels:</b>	Exchange Carrier Name, Data Set Name ("DSN") and volume serial number
<b>Internal labels:</b>	IBM Industry OS labels shall be used. They consist of a single volume label and two (2) sets of header and trailer labels.

### 4.2.4 Rejected Recorded Usage Data

4.2.4.1 Upon agreement between MCI and Sprint, messages that cannot be rated and/or billed by MCI may be returned to Sprint via Connect:Direct. Returned messages shall be sent directly to Sprint in the original EMR format. Standard EMR return codes shall be utilized.

4.2.4.2 Sprint must return EMR/EMI records to IXCs with the OBF standard message reject code which indicates that Sprint no longer serves the end user and which includes the OCN/Local Service Provider ID of the new LEC/Reseller serving the end user.

4.2.4.3 Rejected messages or invoices shall be returned to MCIIm in accordance with procedures and time frames already established between Sprint and MCIIm.

#### 4.2.5 Interfaces

4.2.5.1 Sprint shall transmit formatted Recorded Usage Data to MCIIm via Connect:Direct as designated by MCIIm.

4.2.5.2 MCIIm shall notify Sprint of resend requirements if a pack or entire data set must be replaced due to pack rejection, damage in transit, data set name failure, etc.

4.2.5.3 Critical edit failure on the pack header or pack trailer records shall result in pack rejection (e.g., detail record count not equal to grand total included in the pack trailer). Notification of pack rejection shall be made by MCIIm within one (1) business day of processing. Rejected packs shall be corrected by Sprint and retransmitted to MCIIm within twenty-four (24) hours or within an alternate time frame negotiated on a case-by-case basis.

4.2.5.4 A pack shall contain a minimum of one (1) message record or a maximum of nine thousand nine hundred and ninety-nine (9,999) message records (or the approved OBF standard), plus a pack header record and a pack trailer record. A file transmission contains a maximum of ninety-nine (99) packs. A data set shall contain a minimum of one (1) pack. Sprint shall provide MCIIm one (1) data set per sending location, with the agreed upon RAO/OCN populated in the header and trailer records.

#### 4.2.6 Formats and Characteristics

4.2.6.1 Rated in collect messages can be intermingled with the unrated messages. No special packing is needed.

4.2.6.2 **EMR.** Sprint shall provide recorded usage data in the EMR format and by category, group and record type, and shall be transmitted, via a direct feed, to MCIIm. The following is a list of EMR records that MCIIm can expect to receive from Sprint:

<b>Detail Records *</b>	01-01-01, 06, 08, 09, 14, 17, 18, 31, 32, 35, 37, 80,
-------------------------	--

	81, 82, 10-01-01, 06, 08, 09, 14, 17, 18, 31, 32, 35, 37
<b>Credit Records</b>	03-01-01, 06, 08, 09, 14, 17, 18, 31, 32, 35, 37, 80, 81, 82
<b>Rated Credits</b>	41-01-01, 06, 08, 09, 14, 17, 18, 31, 32, 35, 37, 80, 81, 82
<b>Cancel Records</b>	51-01-01, 06, 08, 09, 14, 17, 18, 31, 32, 35, 37, 80, 81, 82
<b>Correction Records</b>	71-01-01, 06, 08, 09, 14, 17, 18, 31, 32, 35, 37, 80, 81, 82

• Category 01 is utilized for Rated Messages. Category 10 is utilized for Unrated Messages. Category 10 records are to have indicator 13 populated with a value of 5.

4.2.6.2.1 Upon modification of Sprint's process to allow for providing the newly defined industry standard header record resale and trailer record resale, Sprint shall use its interim header and trailer records as defined to MCIIm, which are derivative of the 20-20-01 header record and the 20-20-02 trailer record.

4.2.6.3 Sprint shall comply with the most current version of Bellcore standard practice guidelines for formatting EMR records with the exception noted in 4.2.6.2.1 above.

4.2.6.4 The interfacing Bell RAO, OCN, and remote identifiers shall be used by MCIIm to control invoice sequencing and each shall have its own invoice controls. The OCN shall also be used to determine where the message returns file, containing any misdirected and unguidable usage, shall be sent.

4.2.6.5 The file's Record Format ("RECFM") shall be variable block or fixed as negotiated. Size and the Logical Record Length ("LRECL") shall be as specified by MCIIm.

4.2.6.6 Sprint may elect not to comply with specific sorting requirements. However, MCIIm may elect to negotiate with

Sprint to sort PACKS in accordance with MCIIm specifications at a later date.

4.2.6.7 Sprint shall transmit the usage to MCIIm using data set naming conventions prescribed by MCIIm.

#### 4.2.7 Controls

4.2.7.1 MCIIm and Sprint shall jointly test and certify the Connect:Direct interface to ensure the accurate transmission and receipt of Recorded Usage Data.

4.2.7.2 Until Sprint implements the newly defined industry standard header and trailer records, header and trailer records shall be populated as follows:

Position	
13-16	MCIIm OCN - value 7229

Upon such implementation, Header and trailer records shall be populated in positions 13-27 with the following information:

Position	
13-14	Invoice numbers (1-99)
15-16	Bell Co. ID number
17-19	Interfacing Bell RAO Code
20-23	Interfacing OCN
24-26	Send to RAO
27-30	MCIIm OCN - Value 7229

The trailer grand total record count shall be populated with total records in pack (excluding header and trailer).

**4.2.7.3 Control Reports.** MCIIm accepts input data provided by Sprint in EMR format in accordance with the requirements and specifications detailed in Section 8 of Attachment III. In order to ensure the overall integrity of the usage being transmitted from Sprint to MCIIm, data transfer control reports shall be required. These reports shall be provided by MCIIm to Sprint on a daily or otherwise negotiated basis and reflect the results of the processing for each pack transmitted by Sprint.

**4.2.7.4 Control Reports - Distribution.** Since Sprint is not receiving control reports, data set names shall be established during detailed negotiations.

**4.2.7.5 Message Validation Reports.** MCIIm shall provide the following Message Validation reports to the designated Sprint System Control Coordinator once per day (or as otherwise negotiated). These reports shall be provided for all data received within Sprint local resale feed and shall be transmitted Monday through Friday.

**4.2.7.6 Incollect Pack Processing.** This report provides vital statistics and control totals for packs rejected and accepted and dropped messages. The information is provided in the following report formats and control levels:

4.2.7.6.1 Sprint name;

4.2.7.6.2 Reseller total messages processed in a pack;

4.2.7.6.3 Packs processed shall reflect the number of messages initially erred and accepted within a pack; and

4.2.7.6.4 Reseller total packs processed.

**4.2.7.7** Sprint agrees to provide MCIIm information on a subscriber's selection of billing method, special language billing, and other billing options at Parity with information maintained for Sprint subscribers.

#### **4.2.8 Interim Number Portability - Recording and Billing**

**4.2.8.1** Sprint shall provide MCIIm with accurate billing and customer subscriber account record exchange data for MCIIm subscribers whose numbers have been ported.

4.2.8.1.1 Sprint shall provide MCIIm call detail records identified for IXCs which are sufficient to allow MCIIm to render bills to IXCs for calls IXCs place to ported numbers in the Sprint network which Sprint forwards to MCIIm for termination.



### **4.3 Standards**

4.3.1 When requested by MCIIm for security purposes, Sprint shall provide MCIIm with Recorded Usage Data at Parity. If not available in EMR format, the Recorded Usage Data may be provided in AMA format.

4.3.2 Sprint shall include the Working Telephone Number ("WTN") of the call originator on each EMR call record.

4.3.3 Consistent with 4.2.6.2 above, end user subscriber usage records and station level detail records shall be in packs in accordance with EMR standards.

4.3.4 Sprint shall segregate and organize the Recorded Usage Data in accordance with MCIIm's instructions.

### **4.4 Performance Measurements**

Performance Measurement for File Transfer, Timeliness, Completeness, Accuracy, Data Packs, Recorded Usage Data Accuracy, and Usage Inquiry Responsiveness will be established pursuant to the Implementation Plan described in Part A, Section 34.

### **4.5 Reporting**

4.5.1 Sprint shall agree to develop reports to be used for local usage data performance measurement pursuant to the Implementation Plan in Part A, Section 34

## **Section 5. Maintenance**

### **5.1 General Requirements**

5.1.1 Sprint shall provide repair, maintenance, testing, and surveillance for all Telecommunications Services and unbundled Network Elements and Combinations in accordance with the terms and conditions of this Agreement.

5.1.1.1 During the term of this Agreement, Sprint shall provide necessary maintenance business process support as well as those technical and systems interfaces required to enable MCIIm to provide at least the same level and quality of service for all services for resale, functions, features, capabilities and unbundled elements or Combinations of

elements as Sprint provides itself, its subscribers, any of its Affiliates or subsidiaries, or any other entity. Sprint shall provide MCIIm with the same level of maintenance support as Sprint provides itself in accordance with standards and performance measurements that are at least equal to the highest level of standards and/or performance measurements that Sprint uses and/or which are required by law, regulatory agency, or by Sprint's own internal procedures, whichever are the most rigorous. These standards shall apply to the quality of the technology, equipment, facilities, processes, and techniques (including, but not limited to, such new architecture, equipment, facilities, and interfaces as Sprint may deploy) that Sprint provides to MCIIm under this Agreement.

5.1.1.2 Sprint shall provide, initially on a regional basis, and subsequently on a national basis, a Single Point of Contact ("SPOC") for MCIIm to report via telephone maintenance issues and trouble reports twenty-four (24) hours a day, seven (7) days a week.

5.1.1.3 Sprint shall provide MCIIm maintenance dispatch personnel on the same schedule that they provide their own subscribers.

5.1.2 MCIIm shall handle all interaction with MCIIm subscribers including all calls regarding service problems, scheduling of technician visits, and notifying the subscriber of trouble status and resolution, except any interactions required by on-site technicians.

5.1.3 Sprint shall cooperate with MCIIm to meet maintenance standards for all Telecommunications Services, unbundled Network Elements and Combinations ordered under this Agreement. Such maintenance standards shall include, without limitation, standards for testing, network management, call gapping, and notification of upgrades as they become available.

5.1.4 All Sprint employee or contractors who perform repair service for MCIIm subscribers shall follow procedures, supplied by MCIIm, in all their communications with MCIIm subscribers. At a minimum, these procedures and protocols shall ensure that: (1) Sprint employees or contractors shall perform repair service that is at least equal in quality to that provided to Sprint subscribers; and (2) trouble calls from MCIIm subscribers shall receive response time

priority that is at least equal to that of Sprint subscribers and shall be handled on a "first come, first served" basis regardless of whether the subscriber is a MCI subscriber or a Sprint subscriber.

5.1.5 Sprint shall provide MCI with scheduled maintenance, including, without limitation, required and recommended maintenance intervals and procedures, for all Telecommunications Services, Network Elements and Combinations provided to MCI under this Agreement equal in quality to that currently provided by Sprint in the maintenance of its own network.

5.1.5.1 Sprint shall provide the maximum possible advance notice of any scheduled maintenance activity which may impact MCI's subscribers including a list of all services, elements, features, functions, and capabilities which may be impacted by Sprint maintenance activities. Until electronic bonding is available, such notice shall be for occurrences affecting a minimum of fifty (50) subscribers.

5.1.5.2 Plans for scheduled maintenance shall include, at a minimum, the following information: location and type of facilities, specific work to be performed, date and time work is scheduled to commence, date and time work is scheduled to be completed.

5.1.6 Sprint shall notify MCI of all non-scheduled maintenance or other planned network activities to be performed by Sprint on any Network Element, including, without limitation, any hardware, equipment, software, or system, providing service functionality which may potentially impact MCI subscribers.

5.1.6.1 Sprint shall provide the maximum advance notice of such non-scheduled maintenance and other planned network activities possible, under the circumstances; but in no case shall notice be given to MCI after the work has started to take place.

5.1.6.2 Sprint shall provide emergency maintenance as promptly as possible to maintain or restore service and shall advise MCI promptly of any such actions it takes.

5.1.7 Sprint shall provide MCI a detailed description of any and all emergency restoration plans and disaster recovery plans which

are in place during the term of this Agreement. Such plans may include, at a minimum, the following: (i) provisions for immediate notification to MCIIm of the existence, location, and source of any emergency network outage potentially affecting an MCIIm subscriber; (ii) establishment of a single point of contact responsible for initiating and coordinating the restoration of all local services and Network Elements or Combinations; (iii) methods and procedures to provide MCIIm with real-time access to information relating to the status of restoration efforts and problem resolution during the restoration process; (iv) an inventory and description of mobile restoration equipment, by location; (v) methods and procedures for the dispatch of mobile equipment to the restoration site; (vi) methods and procedures for reprovisioning of all Telecommunications Services and Network Elements or Combinations after initial restoration; (vii) equal priority, as between MCIIm subscribers and Sprint subscribers, for restoration efforts, consistent with FCC service restoration guidelines, including, without limitation, deployment of repair personnel, and access to spare parts and components; and (viii) a mutually agreeable process for escalation of maintenance problems, including a complete, up-to-date list of responsible contacts, each available twenty-four (24) hours per day, seven (7) days per week.

5.1.7.1 For purposes of this Subsection 5.1, an emergency network outage is defined as an outage affecting at least fifty (50) subscribers or five thousand (5,000) or more blocked call attempts in a ten (10) minute period for all subscribers in a single exchange.

5.1.8 On all misdirected calls from MCIIm subscribers requesting repair, Sprint shall provide such MCIIm subscriber with the correct MCIIm repair telephone number as such number is provided to Sprint by MCIIm.

5.1.9 Sprint shall inform MCIIm of repair completion and trouble reason as soon as practicable, with the objective of making the information available within ten (10) minutes after restoration of Network Elements, or Combinations, and any other trouble reports by MCIIm. Notification should be provided via electronic interface.

5.1.10 Sprint and MCIIm shall mutually develop escalation procedures to be followed if, in MCIIm's judgment, any performance standard defined in this Agreement is not met for any individual

trouble report. The escalation procedures to be provided shall include titles and telephone numbers of Sprint management personnel who are responsible for maintenance issues and who will be contacted when a trouble condition is escalated.

5.1.11 In the event Sprint fails to conform to specified performance and service quality standards, MCI may request, and Sprint shall deliver to MCI, plans for correcting said cause, and Sprint shall correct said cause as soon as possible, at its own expense.

5.1.12 Dispatching of Sprint technicians to MCI subscriber premises shall be accomplished by Sprint pursuant to a request received from MCI. MCI shall be able to schedule maintenance appointments in half-day intervals. The electronic interface established pursuant to Subsection 5.2 shall provide the capability of allowing MCI to receive trouble reports, analyze and sectionalize the trouble, determine whether it is necessary to dispatch a service technician to the subscriber's premises, and verify any actual work completed on the subscriber's premises.

5.1.13 Sprint shall supply MCI with a unique number to identify each MCI initial trouble report opened.

5.1.14 Sprint shall flag a trouble report as a repeat trouble if a prior trouble report was closed without repairs being performed to the subscriber's satisfaction. For repeat trouble reports, MCI shall have the ability to escalate repair service requests.

5.1.15 Sprint shall notify MCI via electronic interface upon completion of trouble report. The report shall not be considered closed until such notification is made. MCI will contact its subscriber to determine if repairs were completed and confirm the trouble no longer exists.

#### **5.1.16 Additional Unbundling Requirements**

5.1.16.1 When trouble is reported by a subscriber served through unbundled Network Elements, MCI will test its network to identify any problems. If no problems are identified with the MCI network, MCI will open a trouble report with Sprint. Sprint shall then test its portion of the network and perform repairs as required in the time frames set forth below in this Agreement.

5.1.16.1.1 MCIIm will coordinate combined testing or repair activities until trouble is resolved. Sprint shall provide repair updates to MCIIm.

## **5.2 Systems Interfaces and Information Exchanges**

5.2.1 Sprint shall cooperate with MCIIm to establish real-time, electronic interfaces by MCIIm to Sprint's maintenance systems and databases. This interface shall be seamless and transparent to MCIIm personnel working through MCIIm's systems.

5.2.1.1 An electronic bond will be a system-to-system connection with immediate update capability. In no way shall this interface cause MCIIm personnel to use Sprint systems via remote hook up or any other means of access.

5.2.1.2 This interface shall allow MCIIm personnel to perform the following functions for MCIIm subscribers; (i) enter trouble reports in the Sprint maintenance systems for an MCIIm subscriber; (ii) retrieve and track current status on all MCIIm subscriber trouble reports; and (iii) receive automated notification of case closure.

5.2.1.3 Sprint agrees to develop and implement the electronic interfaces described above based on the trouble administration industry standards developed by the ECIC forum, specifically ANSI standards T1.227 and T1.228. These interfaces will be ready for joint testing seven (7) months after joint planning is commenced provided that: joint planning is completed within five (5) months of initiation, a joint test plan is completed within six (6) months of joint planning initiation, and MCIIm is in compliance with the ANSI T1.227 and T1.228 standards.

5.2.2 Once the electronic Gateway is established between Sprint and MCIIm, Sprint agrees that MCIIm may report troubles directly to a single Sprint repair/maintenance center for both residential and business subscribers, unless otherwise agreed to by MCIIm.

5.2.3 Sprint shall perform all testing for Resale Services.

5.2.3.1 Sprint shall provide test results to MCI, if appropriate, for trouble clearance. In all instances, Sprint will provide MCI with the disposition of the trouble.

5.2.3.2 If Sprint initiates trouble handling procedures, it will bear all costs associated with that activity. If MCI requests the trouble dispatch, then MCI's subscriber will bear the cost.

5.2.4 If systems interfaces are temporarily out of service or not yet in place, Sprint shall provide to MCI the ability to obtain the status on open maintenance trouble reports via telephone or by another interface as mutually agreed by the Parties. Sprint agrees to provide the status of residence and small business trouble reports upon MCI's request.

5.2.5 Sprint agrees to provide to MCI the status for open maintenance trouble reports for large business subscribers at MCI's request.

5.2.6 Sprint agrees that MCI may submit a trouble report to Sprint to verify Central Office features and functions as they relate to a subscriber trouble report. Sprint agrees to work the initial trouble report at Parity with all other trouble reports received.

5.2.7 Sprint agrees to proactively advise MCI of any Central Office failure that is known at the time of any inquiry or trouble report. Sprint agrees to continue to work with MCI toward implementing a process to meet MCI's requirements for notification of Switch failures as soon as possible.

5.2.8 Sprint agrees to provide a repair commit time on all residences and small business trouble reports.

5.2.9 Sprint agrees to develop, with MCI's cooperation, mutually acceptable work center interface agreements to document methods and procedures for interim interfaces for each service within thirty (30) days of the Effective Date of this Agreement or MCI's notice to Sprint of its initiation of that service. Sprint will participate in the appropriate standards bodies in the development of the final interface standards and will comply with such standards as soon as practicable.

### **5.3 Standards**

**5.3.1 Maintenance charges for premises visits by Sprint employees or contractors shall be billed by MCI to its subscriber.**

**5.3.1.1 Sprint employees or contractors shall, present the subscriber with a form pursuant to Section 25.3 of Part A of this Agreement detailing the time spent, the materials used and an indication that the trouble has either been resolved, or that additional work will be necessary.**

**5.3.1.2 If additional work is required, Sprint employees or contractors shall call MCI so that MCI can schedule a new appointment with Sprint and subscriber at Parity with the process Sprint uses for its own subscribers.**

**5.3.2 Sprint agrees to work with MCI to support expeditious development of an industry standard trouble report entry format and agrees to implement such standard not more than twelve (12) months after final resolution by the Electronic Communications Implementation Committee ("ECIC").**

### **5.4 Performance Measurements and Reporting**

#### **5.4.1 Cycle Time Measurements**

**5.4.1.1 Until electronic interface exists, Sprint agrees that MCI may report troubles to Sprint's repair bureau by telephone and/or facsimile at MCI's discretion. Sprint repair bureau shall conform to the following performance and service quality standards when providing repair and maintenance to MCI and MCI subscribers under this Agreement.**

**5.4.1.2 Sprint shall provide repair service to MCI subscribers at Parity with Sprint's provision of repair service to its own subscribers. The standards shall be pursuant to the Implementation Plan in Part A Section 34.**

**5.4.1.3 In the event the "estimated time to restore" has been missed, Sprint shall notify MCI promptly.**



5.4.1.4 Emergency network outages shall be restored in accordance with Sprint's emergency restoration plans as described in Section 5.1.7 above.

5.4.1.4.1 Number of emergency network outages recorded shall be pursuant to the Implementation Plan in Part A, Section 34.

5.4.1.5 The quality standards for when an outage has not reached the threshold defining an emergency network outage, shall be established to the Implementation Plan in Part A, Section 34.

5.4.1.6 For maintenance and trouble management purposes, Telephone Service Prioritization ("TSP") and essential services outages shall be designated for repair at the highest priority one hundred percent (100%) of the time.

5.4.1.7 Trouble reports for other than total service outage shall be established pursuant to the Implementation Plan in Part A Section 34.

5.4.1.8 Sprint tracks repeat trouble reports from the same subscriber on a rolling thirty (30) day period. Sprint's internal objective shall be established pursuant to the Implementation Plan in Part A Section 34.

5.4.1.9 To support unbundling processes, Sprint agrees to support trouble sectionalization and resolution and to respond to MCIIm requests within the timeframe established for assistance pursuant to the Implementation Plan in Part A Section 34.

## 5.4.2 Quality

5.4.2.1 All calls to Sprint's repair bureau shall be answered twenty-four (24) hours per day, seven (7) days per week.

5.4.2.2 The Sprint repair bureau shall provide to MCIIm the "estimated time to restore," with the accuracy established pursuant to the Implementation Plan in Part A Section 34.

## **Section 6. Miscellaneous Services and Functions**

### **6.1 General**

6.1.1 To the extent that Sprint does not provide the services described in this Section 6 to itself, Sprint will facilitate the acquisition of such services for or by MCI<sub>m</sub> through the existing service provider. MCI<sub>m</sub> will contract directly with the service provider for such services.

### **6.2 General Requirements**

#### **6.2.1 Basic 911 and E911 General Requirements**

6.2.1.1 Basic 911 and E911 provides a caller access to the appropriate emergency service bureau by dialing a three (3) digit universal telephone number (911). Basic 911 and E911 access from Local Switching shall be provided to MCI<sub>m</sub> in accordance with the following:

6.2.1.2 E911 shall provide additional routing flexibility for 911 calls. E911 shall use subscriber data, contained in the Automatic Location Identification/ Data Management System ("ALI/DMS"), to determine to which Public Safety Answering Point ("PSAP") to route the call.

6.2.1.3 If available, Sprint shall offer a third type of 911 Service, S911. All requirements for E911 also apply to S911 with the exception of the type of signaling used on the interconnection trunks from the local Switch to the S911 tandem.

6.2.1.4 Basic 911 and E911 functions provided to MCI<sub>m</sub> shall be at least at Parity with the support and services that Sprint provides to its subscribers for such similar functionality.

6.2.1.5 Basic 911 and E911 access when MCI<sub>m</sub> purchases Local Switching shall be provided to MCI<sub>m</sub> in accordance with the following:

6.2.1.5.1 Sprint shall conform to all state regulations concerning emergency services; and

6.2.1.5.2 For E911, Sprint shall use its service order process to update and maintain subscriber information in the ALI/DMS data base. Through this process, Sprint shall provide and validate MCIIm subscriber information resident or entered into the ALI/DMS database.

6.2.1.6 Sprint shall provide for overflow 911 traffic to be routed to Sprint Operator Services or, at MCIIm's discretion, directly to MCIIm Operator Services.

6.2.1.7 Basic 911 and E911 access from the MCIIm local Switch shall be provided to MCIIm in accordance with the following:

6.2.1.7.1 If required by MCIIm, Sprint shall interconnect direct trunks from the MCIIm network to the E911 PSAP, or the E911 tandems as designated by MCIIm. Such trunks may alternatively be provided by MCIIm.

6.2.1.7.2 In government jurisdictions where Sprint has obligations under existing agreements as the primary provider of the 911 System to the county ("Host ILEC"), MCIIm shall participate in the provision of the 911 System as follows:

6.2.1.7.2.1 Each Party shall be responsible for those portions of the 911 System for which it has control, including any necessary maintenance to each Party's portion of the 911 System.

6.2.1.7.2.2 The Host ILEC shall be responsible for maintaining the E-911 database. Sprint shall be responsible for maintaining the E911 routing data base.

6.2.1.7.3 If a third party is the primary service provider to a government agency, MCIIm shall negotiate separately with such third party regarding the provision of 911 Service to the agency. All relations between such third party and MCIIm are totally separate from this Agreement and Sprint makes no representations on behalf of the third party.

6.2.1.7.4 If MCIm or its Affiliate is the primary service provider to a government agency, MCIm and Sprint shall negotiate the specific provisions necessary for providing 911 Service to the agency and shall include such provisions in an amended Agreement to this Agreement.

6.2.1.7.5 Interconnection and database access shall be priced as specified in Attachment I or at any rate charged to other interconnected carriers, whichever is lower.

6.2.1.7.6 Sprint shall comply with established, competitively neutral intervals for installation of facilities, including any Collocation facilities, diversity requirements, etc.

6.2.1.7.7 In a resale situation, where it may be appropriate for Sprint to update the ALI database, Sprint shall update such database with MCIm data in an interval no less than is experienced by Sprint subscribers, nor less than for other carriers, whichever is faster, at no additional cost.

6.2.1.8 Sprint shall provide to MCIm, no later than five (5) days after the Effective Date of this Agreement, the emergency public agency (e.g., police, fire, rescue, poison, and bomb) telephone numbers linked to all NPA NXXs for the states in which they provide service.

6.2.1.9 Sprint shall transmit to MCIm daily all changes, alterations, modifications, and updates to the emergency public agency telephone numbers linked to all NPA NXXs. This transmission shall be electronic and be a separate feed from the subscriber listing feed.

6.2.1.10 Sprint shall provide to MCIm the necessary Network Elements in order for MCIm to provide E911/911 Services to government agencies. If such elements are not available from Sprint, Sprint shall offer E911/911 Service for resale by MCIm to government agencies.

6.2.1.11 The following are Basic 911 and E911 data base requirements:

6.2.1.11.1 The ALI database shall be managed by Sprint, but is the property of Sprint and any participating telephone company and ILEC for those records provided by the company.

6.2.1.11.2 To the extent allowed by the governmental agency, and where available, copies of the MSAG shall be provided within three (3) business days from the time requested and provided on diskette, magnetic tape, or in a format suitable for use with desktop computers.

6.2.1.11.3 MCI shall be solely responsible for providing MCI data base records to Sprint for inclusion in Sprint's ALI database on a timely basis.

6.2.1.11.4 Sprint and MCI shall arrange for the automated input and periodic updating of the E911 database information related to MCI end users. Sprint shall work cooperatively with MCI to ensure the accuracy of the data transfer by verifying it against the Master Street Address Guide ("MSAG"). Sprint shall accept electronically transmitted files or magnetic tape that conform to National Emergency Number Association ("NENA") Version #2 format.

6.2.1.11.5 MCI shall assign an E911 database coordinator charged with the responsibility of forwarding MCI end user ALI record information to Sprint or via a third party entity, charged with the responsibility of ALI record transfer. MCI assumes all responsibility for the accuracy of the data that MCI provides to Sprint.

6.2.1.11.6 MCI shall provide information on new subscribers to Sprint within one (1) business day of the order completion. Sprint shall update the database within two (2) business days of receiving the data from MCI. If Sprint detects an error in the MCI provided data, the data shall be returned to MCI within two (2) business days from when it was provided to Sprint. MCI shall respond to requests from Sprint to make corrections to database record errors by uploading corrected records within two (2)

business days. Manual entry shall be allowed only in the event that the system is not functioning properly.

6.2.1.11.7 Sprint agrees to treat all data on MCIIm subscribers provided under this Agreement as strictly confidential and to use data on MCIIm subscribers only for the purpose of providing E911 Services.

6.2.1.11.8 Sprint shall adopt use of a carrier code (NENA standard five (5) character field) on all ALI records received from MCIIm. The carrier code will be used to identify the carrier of record in INP configurations. The NENA carrier code for MCIIm is "MCIIm".

6.2.1.11.9 Sprint shall identify which ALI databases cover which states, counties or parts thereof, and identify and communicate a point of contact for each.

6.2.1.12 The following are basic 911 and E911 network requirements:

6.2.1.12.1 Sprint, at MCIIm's option, shall provide a minimum of two (2) E911 trunks per Numbering Plan Area ("NPA") code, or that quantity which will maintain P.01 Transmission Grade of Service, whichever is the higher grade of service. These trunks will be dedicated to routing 911 calls from MCIIm's Switch to a Sprint selective router.

6.2.1.12.2 Sprint shall provide the Selective Routing of E911 calls received from MCIIm's switching office. This includes the ability to receive the ANI of MCIIm's subscriber, selectively route the call to the appropriate PSAP, and forward the subscriber's ANI to the PSAP. Sprint shall provide MCIIm with the appropriate CLLI codes and specifications regarding the tandem serving area associated addresses and meet-points in the network.

6.2.1.12.3 Copies of Selective Routing boundary maps shall be available to MCIIm. Each map shows the boundary around the outside of the set of exchange areas served by that selective router. The map provides MCIIm the information necessary to set

up its network to route E911 callers to the correct selective router.

6.2.1.12.4 MCI shall ensure that its Switch provides an eight (8) digit ANI consisting of an information digit and the seven (7) digit exchange code. MCI shall also ensure that its Switch provides the line number of the calling station. Where applicable, MCI shall send a ten (10) digit ANI to Sprint.

6.2.1.12.5 Each ALI discrepancy report shall be jointly researched by Sprint and MCI. Corrective action shall be taken immediately by the responsible Party.

6.2.1.12.6 Where Sprint controls the 911 network, Sprint should provide MCI with a detailed written description of, but not limited to, the following information:

6.2.1.12.6.1 Geographic boundaries of the government entities, PSAPs, and exchanges, as necessary.

6.2.1.12.6.2 LECs Rate Centers/exchanges, where "Rate Center" is defined as a geographically specified area used for determining mileage dependent rates in the public switched telephone network.

6.2.1.12.6.3 Technical specifications for network interface, technical specifications for database loading and maintenance.

6.2.1.12.7 Sprint shall identify special routing arrangements to complete overflow.

6.2.1.12.8 Sprint shall begin restoration of E911 and/or E911 trunking facilities immediately upon notification of failure or outage. Sprint must provide priority restoration of trunks or networks outages on the same terms/conditions it provides itself and without the imposition of Telecommunications Service Priority ("TSP").

6.2.1.12.9 Sprint shall identify any special operator-assisted calling requirements to support 911.

6.2.1.12.10 Trunking shall be arranged to minimize the likelihood of Central Office isolation due to cable cuts or other equipment failures. There will be an alternate means of transmitting a 911 call to a PSAP in the event of failures.

6.2.1.12.11 Circuits shall have interoffice, loop and carrier system diversity when such diversity can be achieved using existing facilities. Circuits will be divided as equally as possible across available carrier systems. Diversity will be maintained or upgraded to utilize the highest level of diversity available in the network.

6.2.1.12.12 Repair service shall begin immediately upon receipt of a report of a malfunction. Repair service includes testing and diagnostic service from a remote location, dispatch of or in-person visit(s) of personnel. Technicians will be dispatched without delay.

6.2.1.12.13 All 911 trunks must be capable of transmitting and receiving Baudot code or ASCII necessary to support the use of Telecommunications Devices for the Deaf ("TTY/TDDs").

#### **6.2.1.13 Basic 911 and E911 Additional Requirements**

6.2.1.13.1 All MCIIm lines that have been ported via INP shall reach the correct PSAP when 911 is dialed. Sprint shall send both the ported number and the MCIIm number (if both are received from MCIIm). The PSAP attendant shall see both numbers where the PSAP is using a standard ALI display screen and the PSAP extracts both numbers from the data that is sent.

6.2.1.13.2 Sprint shall work with the appropriate government agency to provide MCIIm the ten (10) digit POTS number of each PSAP which sub-tends each Sprint selective router/911 tandem to which MCIIm is interconnected.



6.2.1.13.3 Sprint shall notify MCIIm forty-eight (48) hours in advance of any scheduled testing or maintenance affecting MCIIm 911 Service, and provide notification as soon as possible of any unscheduled outage affecting MCIIm 911 Service.

6.2.1.13.4 MCIIm shall be responsible for reporting all errors, defects and malfunctions to Sprint. Sprint shall provide MCIIm with the point of contact for reporting errors, defects, and malfunctions in the service and shall also provide escalation contacts.

6.2.1.13.5 MCIIm may enter into subcontracts with third parties, including MCIIm Affiliates, for the performance of any of MCIIm's duties and obligations stated herein.

6.2.1.13.6 Sprint shall provide sufficient planning information regarding anticipated moves to SS7 signaling, for 911 Services, for the next twelve (12) months.

6.2.1.13.7 Sprint shall provide notification of any impacts to the 911 Services provided by Sprint to MCIIm resulting from of any pending tandem moves, NPA splits, or scheduled maintenance outages, with enough time to react.

6.2.1.13.8 Sprint shall identify the process for the handling of "reverse ALI" inquiries by public safety entities.

6.2.1.13.9 Sprint shall establish the process for the management of NPA splits by populating the ALI database with the appropriate new NPA codes.

6.2.1.13.10 Sprint must provide the ability for MCIIm to update the 911 data base with end user information for lines that have been ported via INP or NP.

## **6.2.2 Directory Assistance Service**

6.2.2.1 Sprint shall provide for the routing of Directory Assistance calls (including, but not limited to, 411, 555-1212,

NPA-555-1212) dialed by MCIIm subscribers directly to, at MCIIm's option, either: (a) the MCIIm Directory Assistance service platform to the extent Sprint's Switch can perform this customized routing, or (b) Sprint Directory Assistance service platform to the extent there is a Directory Assistance service platform for that serving area.

6.2.2.2 MCIIm subscribers shall be provided the capability by Sprint to dial the same telephone numbers for access to MCIIm Directory Assistance that Sprint subscribers dial to access Sprint Directory Assistance.

6.2.2.3 Sprint shall provide Directory Assistance functions and services to MCIIm for its subscribers as described below until Sprint routes calls to the MCIIm Directory Assistance Services platform pursuant to a request from MCIIm.

6.2.2.3.1 Sprint agrees to provide MCIIm subscribers with the same Directory Assistance Services available to Sprint subscribers.

6.2.2.3.2 Sprint shall notify MCIIm in advance of any changes or enhancements to its Directory Assistance Service, and shall make available such service enhancements on a non-discriminatory basis to MCIIm.

6.2.2.3.3 Sprint shall provide Directory Assistance to MCIIm subscribers in accordance with Sprint's internal local operator procedures and standards.

6.2.2.3.4 Sprint shall provide MCIIm with the same level of support for the provisioning of Directory Assistance as Sprint provides itself. Quality of service standards shall be measured at the aggregate level in accordance with standards and performance measurements that are at least equal to the standards and/or performance measurements that Sprint uses and/or which are required by law, regulatory agency, or by Sprint's own internal procedures, whichever are the most rigorous.

6.2.2.3.5 Service levels shall comply, at a minimum, with state regulatory Commission requirements for

number of rings to answer, average work time, and disaster recovery options.

6.2.2.3.6 MCIIm or its designated representatives may inspect any Sprint owned or subcontracted office, which provides Directory Assistance Services, upon five (5) business days notice to Sprint.

6.2.2.3.7 Directory Assistance Services provided by Sprint to MCIIm subscribers shall be branded in accordance with Section 25 of Part A of this Agreement. In the event that Sprint uses automated attendants to perform Directory Assistance Services functions, MCIIm shall have the option of providing its own branding materials.

6.2.2.3.8 Sprint shall provide the following minimum Directory Assistance capabilities to MCIIm's subscribers:

6.2.2.3.8.1 Sprint shall provide to MCIIm subscribers seeking Directory Assistance the same number of responses and detail of information that it provides its own subscribers.

6.2.2.3.8.2 Upon MCIIm's request, call completion to the requested number for local and IntraLATA toll calls shall be sent to the network specified by MCIIm where such call completion routing is Technically Feasible. If fulfillment of such routing request is not Technically Feasible, Sprint shall promptly notify MCIIm if and when such routing becomes Technically Feasible. Rating and billing responsibility shall be agreed to by MCIIm and Sprint.

6.2.2.3.8.3 Populate the Directory Assistance Database in the same manner and in the same time frame as for Sprint subscribers.

6.2.2.3.8.4 Any information provided by a Directory Assistance Automatic Response Unit ("ARU") shall be repeated the same number of

times for MCIIm subscribers as for Sprint's subscribers.

6.2.2.4 Sprint shall provide MCIIm call detail records in a mutually agreed format and manner.

### **6.2.3 Operator Services**

6.2.3.1 Sprint shall provide for the routing of local Operator Services calls (including, but not limited, to 0+, 0-) dialed by MCIIm subscribers directly to either the MCIIm Operator Services platform or Sprint Operator Services platform to the extent Sprint's Switch can perform this customized routing, as specified by MCIIm.

6.2.3.2 MCIIm subscribers shall be provided the capability by Sprint to dial the same telephone numbers to access MCIIm Operator Services that Sprint subscribers dial to access Sprint Operator Service.

6.2.3.3 Sprint shall provide Operator Services to as described below until, at MCIIm's discretion, Sprint routes calls to the MCIIm Local Operator Services platform.

6.2.3.3.1 Sprint agrees to provide MCIIm subscribers the same Operator Services available to Sprint subscribers. Sprint shall make available its service enhancements on a non-discriminatory basis.

6.2.3.3.2 Operator Services provided to MCIIm subscribers shall be branded in accordance with Section 25 of Part A of this Agreement. In the event that Sprint uses automated attendants to perform Operator Services functions, MCIIm shall have the option of providing its own branding materials.

6.2.3.3.3 Sprint shall provide the following minimum Operator Services capabilities to MCIIm subscribers:

6.2.3.3.3.1 Sprint shall complete 0+ and 0-dialed local calls.

6.2.3.3.3.2 Sprint shall complete 0+ IntraLATA toll calls.

6.2.3.3.3 Sprint shall complete calls that are billed to a 0+ access calling card. The Parties shall mutually agree on the acceptable types of special billing.

6.2.3.3.4 Sprint shall complete person-to-person calls.

6.2.3.3.5 Sprint shall complete collect calls.

6.2.3.3.6 Sprint shall provide the capability for callers to bill to a third party and complete such calls.

6.2.3.3.7 Sprint shall complete station-to-station calls.

6.2.3.3.8 Sprint shall process emergency calls.

6.2.3.3.9 Sprint shall process busy line verify and emergency line interrupt requests.

6.2.3.3.10 To the extent not prohibited by law or regulation, Sprint shall process emergency call trace.

6.2.3.3.11 Sprint shall process operator-assisted Directory Assistance calls.

6.2.3.3.12 Sprint shall provide basic rate quotes and/or process time-and-charges requests, subject to Sprint's Operator Systems being capable to perform unique rating for MCI, or Sprint shall route requests to a MCI designated platform.

6.2.3.3.13 Sprint shall route 0- traffic directly to a "live" operator team.

6.2.3.3.14 When requested by MCI, Sprint shall provide instant credit on Operator Services calls as provided to Sprint subscribers or shall inform MCI subscribers to call an 800 number for MCI subscriber

service to request a credit. Sprint shall provide one (1) 800 number for business subscribers and another for residential subscribers.

6.2.3.3.15 Sprint shall provide caller assistance for the disabled in the same manner as provided to Sprint subscribers.

6.2.3.3.16 When available, Sprint shall provide operator-assisted conference calling.

6.2.3.4 Operator Services shall provide MCI's local usage rates when providing rate quote and time-and-charges services, and subject to Section 6.1.3.3.12 above.

6.2.3.5 Operator Service shall adhere to equal access requirements.

6.2.3.6 Sprint shall exercise at least the same level of fraud control in providing Operator Services to MCI that Sprint provides for its own Operator Services.

6.2.3.7 Sprint shall query for billed number screening restrictions when handling collect, third party, and calling card calls, both for station-to-station and person-to-person call types.

6.2.3.8 Sprint shall provide at an aggregate level for the Operator Services Center, service measurements and accounting reports to MCI at Parity with the service measurements and accounting reports Sprint provides to itself or as otherwise mutually agreed by the Parties.

6.2.3.9 MCI or its designated representatives may inspect any Sprint owned or subcontracted office, which provides Operator Services, upon five (5) business days' notice to Sprint.

6.2.3.10 Sprint shall direct MCI subscriber account and other similar inquiries to the subscriber service center designated by MCI.

6.2.3.11 Sprint shall provide call records in accordance with Section 4 of this Attachment VIII.

6.2.3.12 Sprint shall accept and process overflow 911 traffic routed from MCI to the underlying platform used to provide Operator Services where such overflow is performed by Sprint for its subscribers.

**6.2.3.13 Busy Line Verification and Emergency Line Interrupt**

6.2.3.13.1 Sprint shall permit MCI to connect its Local Operator Services to Sprint's Busy Line Verification and Emergency Line Interrupt ("BLV/ELI").

6.2.3.13.2 Sprint shall engineer its BLV/ELI facilities to accommodate the anticipated volume of BLV/ELI requests during the busy hour. MCI may, from time to time, provide its anticipated volume of BLV/ELI requests to Sprint. In those instances when the BLV/ELI systems and data bases become unavailable, Sprint shall promptly inform MCI.

6.2.3.14 Where INP is deployed and when a BLV/BLI request for a ported number is directed to a Sprint operator and the query is not successful (*i.e.*, the request yields an abnormal result), the operator, where possible, shall confirm whether the number has been ported and shall direct the request to the appropriate operator.

**6.2.4 Directory Assistance and Listings Service Requests**

6.2.4.1 These requirements pertain to Sprint's Directory Assistance and Listings service request process that enables MCI to: (a) submit MCI subscriber information for inclusion in Sprint Directory Assistance and Directory Listings Data Bases; (b) submit MCI subscriber information for inclusion in published directories; and (c) provide MCI subscriber delivery address information to enable Sprint to fulfill directory distribution obligations.

6.2.4.1.1 Sprint shall accept orders on a real-time basis via electronic interface in accordance with OBF directory service request standards within three (3) months of final standard adoption. In the interim, Sprint shall create a standard format and order

process by which MCIIm can place an order with a single point of contact within Sprint.

6.2.4.1.2 Sprint will provide to MCIIm the following Directory Listing migration options, valid under all access methods, including but not limited to, resale, unbundled Network Elements and facilities-base:

6.2.4.1.2.1 Migrate with no changes: retain all white page listings for the subscriber in both Directory Assistance and Directory Listings. Transfer ownership and billing for white page listings to MCIIm.

6.2.4.1.2.2 Migrate with additions: retain all white page listings for the subscriber in both Directory Assistance and Directory Listings. Incorporate the specified additional listings order. Transfer ownership and billing for the white page listings to MCIIm.

6.2.4.1.2.3 Migrate with deletions: retain all white page listings for the subscriber in both Directory Assistance and Directory Listings. Delete the specified listings from the listing order. Transfer ownership and billing for the white page listings to MCIIm.

6.2.4.1.3 To ensure accurate order processing, Sprint or its directory publisher shall provide to MCIIm the following information, with updates promptly upon changes:

6.2.4.1.3.1 A matrix of NXX to Central Office;

6.2.4.1.3.2 Geographical maps if available of Sprint service area;

6.2.4.1.3.3 A description of calling areas covered by each directory including, but not limited to, maps of calling areas and matrices depicting calling privileges within and between calling areas;

6.2.4.1.3.4 Yellow page heading codes;



6.2.4.1.3.5 Directory names and codes, identification of which telephone directories are provided to which subscribers by subscriber address, NPA/NXX, or other criteria;

6.2.4.1.3.6 Directory product changes

6.2.4.1.3.7 Listing format rules;

6.2.4.1.3.8 Listing alphabetizing rules;

6.2.4.1.3.9 Standard abbreviations acceptable for use in listings and addresses;

6.2.4.1.3.10 Titles and designations; and

6.2.4.1.3.11 A list of all available directories and their business office close dates.

6.2.4.1.4 Based on changes submitted by MCIIm, Sprint shall update and maintain Directory Assistance and Directory Listings data for MCIIm subscribers who:

6.2.4.1.4.1 Disconnect service;

6.2.4.1.4.2 Change carrier;

6.2.4.1.4.3 Install service;

6.2.4.1.4.4 Change any service which affects Directory Assistance information;

6.2.4.1.4.5 Specify non-solicitation; and

6.2.4.1.4.6 Are non-published, non-listed, or listed.

6.2.4.1.5 Sprint shall not charge for storage of MCIIm subscriber information in the Directory Assistance and Directory Listings systems.

6.2.4.1.6 MCIIm shall not charge for storage of Sprint subscriber information in the Directory Assistance and Directory Listings systems.

### **6.2.5 Directory Listings General Requirements**

MCIIm acknowledges that many directory functions including, but not limited to, yellow page listings, enhanced white page listings, information pages, directory proofing, and yellow pages directory distribution are not performed by Sprint but rather are performed by and are under the control of the directory publisher. Sprint shall use reasonable efforts to assist MCIIm in obtaining an agreement with the directory publisher that treats MCIIm at Parity with the publisher's treatment of Sprint.

**6.2.5.1** This Section 6.2.5 pertains to listings requirements published in the traditional white pages.

**6.2.5.2** Sprint shall include in its master subscriber system data base all white pages listing information for MCIIm subscribers in Sprint territories where MCIIm is providing local telephone exchange services.

**6.2.5.3** Sprint shall not sell or license, nor allow any third party, the use of MCIIm subscriber listings without the prior written consent of MCIIm. Upon consent, MCIIm shall receive its pro rata share of any amounts paid by third parties to Sprint for such information. Sprint shall not disclose nor allow any third party to disclose non-listed name or address information for any purpose other than what may be necessary to complete directory distribution.

**6.2.5.4** MCIIm subscriber listings shall be interfiled with listings of Sprint and other CLEC subscribers.

**6.2.5.5** Each MCIIm subscriber account number shall be provided, at no charge, the same white page basic listings that Sprint provides its subscribers.

**6.2.5.6** Sprint does not publish yellow pages. All arrangements involving yellow page listings must be between MCIIm and the yellow pages publisher.

**6.2.5.7** State, local, and federal government listings shall be included in the appropriate section of the directory at charges in Parity with Sprint's own policies.

**6.2.5.8** At least ten (10) days prior to the date on which updates to the directory are no longer allowed (the business

office close date), Sprint shall provide MCIIm a method of reviewing and correcting MCIIm subscriber white pages Directory Listings.

6.2.5.9 Sprint shall distribute, or ensure a third party shall distribute, traditional white pages to MCIIm subscribers at no charge: (1) upon establishment of new service; and (2) during annual mass distribution. Upon subscriber request, at Sprint's standard rates, Sprint shall distribute or ensure a third party shall distribute, traditional white pages to MCIIm subscribers. Sprint shall provide MCIIm its policy concerning the number of telephone directories it provides to its subscribers upon subscriber request. Sprint shall provide MCIIm their policy on number of telephone directories provided at no charge to the subscriber.

6.2.5.10 Sprint shall permit, or ensure a third party permits, MCIIm subscribers to place orders for foreign directories on the same terms and conditions such directories are made available to Sprint subscribers. Sprint shall provide to MCIIm the procedures, terms, and conditions for obtaining foreign telephone directories from Sprint.

6.2.5.11 Sprint or its directory publisher, and MCIIm shall agree on a reasonable number of directories that will be provided to MCIIm upon its request for MCIIm's internal use to cover Sprint's service areas in which MCIIm is an authorized CLEC.

6.2.5.12 Sprint shall make available current recycling services to MCIIm subscribers under the same terms and conditions that Sprint makes such services available to its subscribers.

## **6.2.6 Directory Assistance Data**

6.2.6.1 This section refers to the residential, business, and government subscriber records used by Sprint to create and maintain databases for the provision of live or automated operator-assisted Directory Assistance. Directory Assistance data is information that enables telephone exchange carriers to swiftly and accurately respond to requests for directory information including, but not limited to, name, address and phone numbers. Under the provisions of the ACT and the FCC's Interconnection Order,

Sprint shall provide unbundled and non-discriminatory access to the residential, business and government subscriber records used by Sprint to create and maintain databases for the provision of live or automated operator-assisted Directory Assistance. MCIIm may combine this element with any other Network Element for the provision of any Telecommunications Service.

6.2.6.2 Sprint shall provide an initial load of subscriber records via magnetic tape for Sprint and upon prior approval from such other parties, ILECs, CLECs and independent Local Exchange Companies, included in their Directory Assistance Database within sixty (60) days of the Effective Date of this Agreement. The NPAs included shall represent the entire Sprint operating region. The initial load shall reflect all data that is current as of one (one) business day prior to the provision date.

6.2.6.3 Sprint shall provide to MCIIm a complete list of ILECs, CLECs, and independent Local Exchange companies that provided data to Sprint for its Directory Assistance Services Database.

6.2.6.4 All Directory Assistance data shall be provided in a mutually agreed format.

6.2.6.5 On a daily basis, Sprint shall provide updates (end user and mass) to the Directory Assistance Database via electronic data transfer. Updates shall be current as of one (1) business day prior to the date provided to MCIIm.

6.2.6.6 Directory Assistance data shall specify whether the subscriber is a residential, business, or government subscriber, to the extent Sprint so marks its own Directory Assistance Database records with such indication. Additionally, data must include all levels of indentation and all levels of information specified in "Directory Assistance Data Information Exchanges and Interfaces" below, to the extent Sprint's data is so formatted.

6.2.6.7 Sprint shall provide complete refresh of the Directory Assistance data upon request by MCIIm.

6.2.6.8 MCIIm will designate the location to which the data will be provided, and MCIIm shall order Directory Assistance data from Sprint at a state/company level.

### **6.3 Systems Interfaces and Exchanges**

#### **6.3.1 Directory Assistance Data Information Exchanges and Interfaces**

##### **6.3.1.1 Subscriber List Information**

6.3.1.1.1 Sprint shall provide to MCIIm, within sixty (60) days after the Effective Date of this Agreement, or at MCIIm's request, all published subscriber list information (including such information that resides in Sprint's master subscriber system/accounts master file for the purpose of publishing directories in any format as specified by the ACT) via an electronic data transfer medium and in a mutually agreed to format, on the same terms and conditions and at the same rates that the Sprint provides subscriber list information to itself or to other third parties. All changes to the subscriber list information shall be provided to MCIIm pursuant to a mutually agreed format and schedule. Both the initial list and all subsequent lists shall indicate for each subscriber whether the subscriber is classified as residence or business class of service.

6.3.1.1.2 MCIIm shall provide Directory Listings to Sprint pursuant to the directory listing and delivery requirements in the approved OBF format, at a mutually agreed upon time frame. Other formats and requirements shall not be used unless mutually agreed to by the Parties.

6.3.1.2 This Section addresses data format requirements and data inclusion requirements for Directory Assistance data information exchange between Sprint and MCIIm. Sprint shall provide MCIIm the following, where available:

6.3.1.2.1 List of NPA-NXXs relating to the listing records being provided.

6.3.1.2.2 List of directory section names and their associated NPA-NXXs.

6.3.1.2.3 List of community names expected to be associated with each of the NPA-NXXs for which listing records shall be provided.

6.3.1.2.4 List of independent company names and their associated NPA-NXXs for which their listing data is a part of Sprint's directory data base, but Sprint is not to provide the listing data to MCI under this request.

6.3.1.2.5 Listing volume totals by directory section, NPA, and state.

6.3.1.2.6 Average daily update volume by directory section, NPA, and state.

6.3.1.2.7 Identify any area wide or universal service numbers which may be listed. Identify the telephone number to be provided to callers outside the servicing area.

6.3.1.2.8 Identify any listing condition(s) unique to Sprint's serving area which may require special handling in data processing in the directory. Indented listings (captions) should be identified, delivered and handled as specified.

### **6.3.1.3 Considerations Relating to an Indented Listing (Caption) Set Requirements**

6.3.1.3.1 Use of line numbers, or other methods, to ensure the integrity of the caption set and identify the sequence or placement of a listing record within the caption set. A sufficient range of numbers between listing records is required to allow for the expansion of the caption set. A method is also required to permit the caption header record to be identified, but each level of indent is not required to be recapped. Placement of the indent is based on line number. This method does require stringent edits to ensure the integrity of the caption set.

6.3.1.3.2 Use of guideline or recapped data to identify previously established header and sub-header records for placement of data within the caption set. This permits flexibility to easily expand the caption set. This method also requires that, in addition to the caption header record, each level of indent be recapped in order to properly build the caption set.

6.3.1.3.3 MCIIm requires listing instruction codes on the service order which indicate how the set is to appear in the published directory.

**6.3.1.4 Data Processing Requirements.** Sprint and MCIIm shall mutually agree to standards on the following data processing requirements:

6.3.1.4.1 Identify type of tape to be used in sending the test and initial load data (e.g., reel or cartridge tape). Due to the size of an initial load, it would generally be expected to be on tape and the daily update activity via another media, and via a mutually agreed to time frame, such as Connect:Direct.

6.3.1.4.2 Identify tape or data set label requirements.

6.3.1.4.3 Identify tracking information requirements (e.g., use of header and trailer records for tracking date and time, cycle numbers, sending and receiving site codes, volume count for the given tape/data set). It may also be helpful to have some filler fields for future use.

6.3.1.4.4 Identify dates which the other Party should not expect to receive daily update activity.

6.3.1.4.5 Data should be received in uppercase and lowercase pursuant to OBF standards. An asterisk (\*) should be used advise of the need to apply the reverse capitalization rule. However, if the provider determines to provide the listing data from a data base that has already messaged the data and applied the capitalization rules, the asterisk may be omitted.

6.3.1.4.6 Identify information that shall enable MCI to identify listings within an indented list (caption) set. For example:

6.3.1.4.6.1 When a particular listing has been designated to be filed as the first listing for a given level (0-7) of indent, usually out of alpha sequence; or

6.3.1.4.6.2 When an alternate call listing (e.g., if no answer) relates to multiple preceding listings of the same level.

6.3.1.4.7 Identify any other pertinent information needed to properly process the data.

#### 6.3.1.5 Listing Types

LISTED	The listing information is available for all directory requirements.
NON-LISTED	The listing information is available to all directory requirements, but the information does not appear in the published street directory.
NON-PUBLISHED	A directory service may confirm, by name and address, the presence of a listing, but the telephone number is not available. The listing information is not available in either the published directory or Directory Assistance.

#### 6.3.1.6 Listing Styles

<u>LISTING STYLE</u>	<u>DESCRIPTION</u>
STRAIGHT LINE	All listing information is formatted in a straight line. Data generally consists of name, address, community, and telephone number. Additional data may consist of dialing instructions or other general information relating to the listing.
INDENTED LISTING SET-CAPTION SET	Formatted with one (1) listing header record and multiple indented listing records. See detailed description below.



INDENTED LISTING (CAPTION) SET

HEADER RECORD	Contains listed name. Address and telephone number data fields are blank.
SUB-HEADER RECORD/ LISTING	May contain name data only. Associated subordinate records are required.
INDENTED NAME LISTING	Contains name data, and may or may not have address data, and telephone number data
INDENTED ADDRESS LISTING	Contains address and telephone number data. The name data text field is blank.
LEVEL OF INDENT	Header record is zero (0), sub-header and indented records range from 1 -6.

**6.3.1.7 Data Field Elements**REQUIREMENTS FOR INITIAL PROCESSING AND DAILY UPDATE ACTIVITY

<u>DATA FIELD</u>	<u>DATA ELEMENT</u>	<u>FIELD LENGTH</u>
ACTION CODE	A = Add                      I = In D = Delete      or      O = Out	Required: 1 alpha character
RECORD NUMBER	Sequentially assigned number to each record for a given process (test, initial load, or update activity). Number assignment begins with 00000001 and is incremented by 1 for each record on the file.	Required: 8 digits
NPA	Area code relating to the directory section the record is to be listed	Required: 3 digits
COMPANY IDENTIFIER	The 4-character company code as defined in Section 8 of the National Exchange Carrier Association, Inc. Tariff	Required: 4 digits
DIRECTORY SECTION	Name of the directory section where the record is to be listed	Required: Maximum of 50 alpha characters
LISTING	F = Foreign	Optional: 1 alpha character

IDENTIFIER	<p>C = Cross-Reference  E = Enterprise (WX number requiring operator assistance to connect the call)  W = Wide area or universal service</p>	
FILE PLACEMENT	<p>B = Business (4)  R = Residence (1)  G = Government (2)  BR = Business &amp; Residence (5)  BG = Business &amp; Government (6)  BRG = Business, Residence, &amp; Government (7)</p>	Required: Maximum of 3 alpha characters
LISTING TYPE	<p>L = Listed  N = Non-Listed  NP = Non-Published</p>	Required: Maximum of 2 alpha characters
ADVANCE LISTING	<p>AVL = Advance listing</p> <p>This is used when it is very close to the business office close date and the service is not actually established, but the subscriber needs to be in the directory. Once the service is established, a second order is placed without the indicator and the listing is established permanently and sent to Directory Assistance.</p>	Optional: 3 alpha characters
LISTING STYLE	<p>S = Straight line  I = Indented listing set  CH = Caption header  CS = Caption sub-header</p> <p>An indented listing relates to either a caption or Straight Line Under ("SLU") set listing.</p>	Required: 2 Alpha Characters
INDENT LEVEL	<p>0 = Non-indented record  1 - 6 = Level of indented record</p>	Required: 1 digit
ADDRESS	<p><i>E.g.</i>, 123, A-123, 123-1/2</p>	Optional: Maximum of 20

HOUSE NUMBER		alphanumeric characters, including hyphen, space, and slash
ADDRESS PRE-DIRECTIONAL	<i>E.g., N, S, E, W, NE, SW, NORTH</i>	Optional: Maximum of 5 alpha characters
ADDRESS STREET NAME	<i>E.g., Main, Peachtree-Dunwoody, HWY 75 at Exit 30</i>	Optional: Maximum of 100 alpha, alphanumeric characters, including spaces and hyphens
ADDRESS SUFFIX OR THOROUGHFARE	<i>E.g., SUITE 160, ST, or WAY</i>	Optional: Maximum of 20 numeric, alpha, or alphanumeric characters
ADDRESS POST DIRECTION	<i>E.g., N, S, NE, SW</i>	Optional: Maximum of 5 alpha characters
ADDRESS ZIP CODE	5-digits or ZIP + 4	Optional: Maximum of 10 digits, including the hyphen when using ZIP + 4
COMMUNITY NAME	Identifies the name of the community associated with the listing record. See glossary for more details.	Maximum of 50 alphanumeric characters, including spaces and hyphen
STATE NAME ABBREVIATION	Identifies the state associated with the community name; 2-character state abbreviation used by the U.S. Postal Service.	Maximum of 2 alpha characters
INFORMATION TEXT	Miscellaneous information relating to the listing. Including, but not limited to ( <i>e.g.</i> , toll free dial 1 & then, call collect, or TDD only. The various types of information text must be identified to MCI).	Optional: Maximum of 250 alpha, numeric, or alphanumeric characters

NAME - FIRST WORD	Surname of a residence or business listing, or first word of a business or government listing  Multi-word or hyphenated surnames should be treated as one word	Required for a zero (0) level record. Optional if an indented (level 1-8) record, unless the name text present in the indented record relates to a surname.  Maximum of 50 alpha, numeric, alphanumeric, or special characters
NAME - SUBSEQUENT WORD(S)	Given name and/or initial(s) of a surname listing or additional word(s) for a business or government listing	Expected if the first word is the surname of a residence or business listing. maximum of 250 alpha, numeric, special, or alphanumeric characters.
LINEAL DESCENT	<i>E.g.</i> , SR, JR, III. If lineal descent data cannot be uniquely identified, it should be included with the listed name subsequent word(s) data and placed at the end of the name data.	Optional: Maximum 10 alpha characters
TITLE(s)	<i>E.g.</i> , MRS, LT COL, RET SGR, DR. Multiple titles are acceptable. If title data cannot be uniquely identified, it should be included with the listed name subsequent word(s) data and placed at the end of the name data stream. If lineal descent is also in the listed name subsequent word(s) data field, title data should be placed following the lineal descent data.	Optional: Maximum of 20 alpha characters

DEGREE	<i>E.g.</i> , MD, CPA, PHD. Multiple degrees are acceptable. If degree data cannot be uniquely identified, it should be included with the listed name subsequent word(s) data and placed at the end of the name data stream. If lineal descent and/or title data is also present, it should follow title data.	Optional: Maximum of 20 alpha characters
NICKNAME	Another name the listed subscriber may be known by.	Optional: Maximum of 20 alpha characters
BUSINESS DESIGNATION	Term used to identify the listed subscriber's profession, business, or location ( <i>e.g.</i> , ATTY, CARPETS, OFC)	Optional: Maximum of 50 alpha characters
STANDARD TELEPHONE NUMBER *	NPA NXX-LINE	Optional: 12 characters, including space and hyphen
NON-STANDARD TELEPHONE NUMBER *	Telephone numbers less than or more than the standard telephone number.	Optional: Minimum of 1 digit, maximum of 22 characters, including spaces and hyphens

\* Either a standard or non-standard telephone is required for a zero level record unless the record is a cross-reference listing or an indented listing (caption) set record. A telephone number may, or may not be present on an indented listing set record for level(s) 0-6.

YELLOW PAGE PUBLISHERS ASSOCIATION ("YPPA")	MCI shall provide to Sprint the code for the directory in which the listing is to be placed.
---	--

#### 6.4 Systems Security

6.4.1 Sprint shall provide an appropriate and sufficient back-up and recovery plan to be used in the event of a system failure or emergency.

6.4.2 Where technically available, Sprint shall install controls to: (i) disconnect a user for a pre-determined period of inactivity on authorized ports; (ii) to protect user Proprietary Information; and (iii) ensure both ongoing operational and update integrity.

6.4.3 Sprint shall provide network security: (i) ensuring that all systems and modem access are secured through security methods; and (ii) ensuring that access to or connection with a systems platform be established through mutually agreed networks or Gateways.

6.4.4 Sprint agrees to comply with industry accepted standards which in large measure reflect common practices and proven technology for protecting computer resources.

## **6.5 Law Enforcement Interface**

6.5.1 Pursuant to valid legal authorization, Sprint shall provide seven (7) day a week/twenty-four (24) hour a day installation and information retrieval pertaining to traps, assistance involving emergency traces and information retrieval on subscriber invoked CLASS services, including, without limitation, call traces requested by MCI.

**TABLE OF CONTENTS**

**Attachment IX  
PERFORMANCE STANDARDS REPORTING AND REMEDIES**

Section 1.	General	IX-1
Section 2.	Parity and Quality Measurements	IX-1

## ATTACHMENT IX

### PERFORMANCE STANDARDS REPORTING AND REMEDIES

#### ***Section 1. General***

1.1 Sprint shall satisfy all service standards, intervals, measurements, specifications, performance requirements, technical requirements, and performance standards ("Performance Standards") that are specified in this Agreement or are required by law or regulation. In addition, Sprint's performance under this Agreement shall be provided to MCI, at a minimum, at Parity with the performance that Sprint provides itself for like service(s).

1.2 Sprint and MCI agree that generally remedies at law alone are inadequate to compensate MCI for any failures to meet the Performance Standard requirements specified in this Agreement, or for failures to provide Recorded Usage Data in accordance with this Agreement. Therefore, MCI shall have the right to seek injunctive relief and other equitable remedies to require Sprint: (i) to cause the service ordered by MCI to meet the Performance Standards specified by the Agreement; (ii) install or provision service ordered by MCI within the due dates specified in this Agreement; and (iii) to provide Recorded Usage Data in accordance with this Agreement.

1.3 Sprint and MCI agree that all financial remedies available to end user and access customers for same or like services will be offered to MCI. At such time that state or federal commission-approved credits/financial remedies are put in place between Sprint and any of its affiliates or CLEC customers or, between MCI and Ameritech, the Parties agree to amend this Agreement to incorporate such arrangements.

#### ***Section 2. Parity and Quality Measurements***

2.1 Sprint shall provide to MCI, at a minimum, the comparative reports described in this Attachment IX on a monthly basis. The Implementation Plan in Part A shall establish the time frames for implementing these reports. These reports shall compare Sprint's results with MCI's results and other CLECs' results, and may be presented by state, area code, NXX, product feature, end office and/or any other agreed manner as determined through the Implementation Plan process.

2.2 Sprint will develop and implement the following measures:



**2.2.1 Pre-Ordering/Ordering/Provisioning**

2.2.1.1 Percentage of Commitment Times Met - Service Order

2.2.1.2 Prompt Transmission of Customer Service Record ("CSR") Information

2.2.1.3 Prompt Transmission of Firm Order Confirmation ("FOC")

2.2.1.4 PIC Changes Completed Within Twenty-Four (24) Hours

2.2.1.5 Disconnect Order Completion Interval

**2.2.2 Interconnection**

2.2.2.1 Trunk Orders on or Before the Committed Due Date

2.2.2.2 Firm Order Confirmation ("FOC") time delivery

2.2.2.3 Rights of Way ("ROW"), Conduit and Pole Attachment Availability

**2.2.3 Maintenance and Repair**

2.2.3.1 Average Clearing Time - Out of Service

2.2.3.2 Percentage of Commitment Times Met - Trouble Report

2.2.3.3 Trouble Reports per 100 Access Lines (Resale only)

2.2.3.4 Percent Repeated Trouble Reports

2.2.3.5 Percent Reporting Trouble Within Five (5) Days of the Date Installed

**2.2.4 Billing**

2.2.4.1 Advance Notice of Late Billing Associated with the Wholesale Bill

2.2.4.2 Delivery of Mechanized Customer Service Record ("CSR") for Wholesale Bill Verification

2.2.4.3 Charges Billed in Current Wholesale Bill Period for Flat Rated Services

2.2.4.4 Charges Billed Within Ninety (90) Days for Usage Charges

2.2.4.5 Financial Accuracy of Local OCC Bills

2.2.4.6 Customer Usage Data - File Transfer

2.2.4.7 Customer Usage Data - Timeliness

2.2.4.8 Customer Usage Data - Accuracy

2.2.5 **Operator Services** (only if utilized by MCI)

2.2.5.1 Average Toll Answer Time

2.2.5.2 Average Directory Assistance Answer Time

2.3 All the above measures will be implemented in a manner that is consistent with the current measures Sprint makes of its own performance.

2.4 The Parties may mutually agree to further require additional and/or modified reporting as part of the Implementation Plan in Part A, or subsequently as business needs demand.