

PG&E
Generating Company

ORIGINAL

Okeechobee System
Impact Study

Final Report
Volume I

October 1999

991462
DOCUMENT NUMBER-DATE
13120 OCT 25 99
EPSC-RECORDS/REPORTING



PG&E Generating Company Okeechobee System Impact Study

FINAL REPORT

Principle Contributors:

Kara Clark, GEII PSEC

Brian Jacobsen, GEII PSEC

Goran Drobnyak, GEII PSEC

Roger E. Clayton, PG&E Generating

OCTOBER 1999

Power Systems Energy Consulting

General Electric International, Inc.

One River Road

Schenectady, New York 12345

<http://www.ge.com.powersystemeng>



LEGAL NOTICE

This report was prepared by General Electric International Inc.'s Power Systems Energy Consulting Department (PSEC) as an account of work sponsored by PG&E Generating Company. Neither PG&E Generating Company, nor General Electric International Inc., nor any person acting on behalf of any:

1. Makes any warranty or representation, expressed or implied, with respect to the use of any information contained in this report, or that the use of any information, apparatus, method, or process disclosed in the report may not infringe privately owned rights; or
2. Assumes any liabilities with respect to the use of or for damage resulting from the use of any information, apparatus, method, or process disclosed in this report.



TABLE OF CONTENTS

1.	SUMMARY	1
2.	INTRODUCTION	4
3.	STUDY APPROACH	5
	3.1 Benchmark System Conditions.....	5
	3.2 Okeechobee Dispatch Scenarios.....	13
	3.3 Sensitivity Scenario.....	27
	3.4 Performance Criteria.....	27
	3.5 Contingency List.....	29
4.	POWER FLOW ANALYSIS	31
	4.1 Pre-contingency Violations.....	31
	4.2 Post-contingency Violations.....	32
	4.2.1 Okeechobee Summer Dispatch Scenarios.....	32
	4.2.2 Okeechobee Winter Dispatch Scenarios.....	34
	4.3 New Smyrna Beach Sensitivity Scenario.....	35
5.	SHORT CIRCUIT ANALYSIS	37
6.	PV ANALYSIS	38
7.	STABILITY ANALYSIS	43
	7.1 Okeechobee Dispatch Scenarios.....	43
	7.2 Sensitivity Analysis.....	44
8.	CONCLUSIONS AND RECOMMENDATIONS	46
	Appendix A. Transmission Line Rating Additions	A-1
	Appendix B. Okeechobee Plant Dynamic Models	B-1
	Appendix C. Power Flow Analysis Contingency List	C-1
	Appendix D. Power Flow Analysis Results	D-1
	Appendix E. Stability Analysis Results	E-1



1. SUMMARY

PG&E Generating is proposing to build a new gas-fired power plant near the Sherman 230kV substation in southeastern Florida. The proposed plant will loop into the existing Sherman-Martin 230kV line at a new substation called Okeechobee, which will be located approximately 3 miles south of the Sherman substation. The Okeechobee plant will have a maximum summer power output of 516.5MW and a maximum winter power output of 563.5MW.

PG&E Generating retained GEII's Power System Energy Consulting (PSEC) group to perform a system impact study to evaluate the impact of the Okeechobee plant on power system performance. This study conforms to the criteria specified in the document, *Methodology for Completing a System Impact Study*, which was provided by Hector Sanchez of FPL as Appendix No. 2 to Exhibit 1 to Attachment D in response to a PG&E Generating request dated July 23, 1999. In compliance with the *Form of System Impact Study Agreement* provided by FPL as Exhibit 1 to Attachment D and the FRCC's *Planning Principles and Guides*, this study focused on the reliability of the FPL system and the peninsular Florida bulk transmission system (voltage levels > 115kV). Therefore, power flow, short circuit, PV (power-voltage) and transient stability analyses were performed.

The analyses were designed to evaluate the impact of the Okeechobee plant by focusing on the relative performance of the system with the proposed plant in comparison to that of the existing (benchmark) system. The results are summarized below.

Power Flow Analysis

The power flow results, described in Section 4, show that a number of lines and transformers exceed their ratings for the 2003 summer benchmark system (without Okeechobee) under normal operating conditions (all lines in-service). Several pre-contingency voltage violations were also observed. Similarly, a number of branches exceed their ratings for the 2003 winter benchmark system under normal operating conditions, and several pre-contingency voltage violations were observed.

No pre-contingency adverse rating violations were observed with the Okeechobee plant in-service, for any of the studied dispatch scenarios. A few pre-contingency adverse voltage violations were observed with the Okeechobee plant in-service for several dispatch scenarios.

The post-contingency power flow analysis showed that a number of lines and transformers exceed their ratings for both the 2003 summer and 2003 winter



benchmark systems. Post-contingency voltage violations were also observed in both benchmark systems.

One 101% post-contingency adverse rating violation was observed in the FPC system for one contingency under one 2003 summer Okeechobee dispatch scenario. Several post-contingency adverse voltage violations were observed.

The post-contingency power flow analysis under 2003 winter conditions showed several adverse rating violations in the FPL system with magnitudes less than or equal to 108%. Several post-contingency adverse voltage violations were observed. All voltage violations, both pre-contingency and post-contingency, were relatively minor in magnitude and likely to be easily mitigated.

The apparent rating violations may be simulation artifacts and require further study. All voltage violations, both pre-contingency and post-contingency, were relatively minor in magnitude and likely to be easily mitigated.

Short-Circuit Analysis

The short circuit results show that the three-phase fault currents do not exceed 50kA at any of the 230kV or 500kV buses in the immediate vicinity of the Okeechobee plant.

PV Analysis

The PV analysis focused on the impact of an increase in power transfer from the SERC region on the Florida 500kV and 230kV bus voltages. The starting point for the benchmark PV analysis was the 2003 benchmark summer power flow. The increase in power flow across the Georgia/Florida interface was implemented by increasing the power generated at large generating plants outside Florida and decreasing the power generated at the Port Everglades and Lauderdale plants.

The Florida 500kV and 230kV bus voltages with all lines in-service were acceptable throughout the simulation, with or without the Okeechobee plant. For the contingency cases, a voltage collapse occurs at a Georgia/Florida interface flow of approximately 3650MW for the Turkey Pt. outage, and 3500MW for the St. Lucie outage – again, with or without the Okeechobee plant. This screening analysis indicates that the Okeechobee plant has negligible impact on the PV performance of the Georgia/Florida interface.

Stability Analysis

Under the 2003 summer and winter system conditions, the system response for all contingencies was first-swing stable with well-damped oscillations for the benchmark cases as well as for all Okeechobee dispatch scenarios. However, three Turkey Pt. units lost synchronism in response to contingency 10 (3-phase fault at Turkey Pt. 230kV bus, 5-cycle tripping of Turkey Pt. #3, 12-cycle backup tripping



of Turkey Pt.-Galloway 230kV line). These units lost synchronism for the benchmark cases as well as for all Okeechobee dispatch scenarios. Therefore, the addition of the Okeechobee plant has no significant impact on the performance of the Turkey Pt. units in response to this severe contingency.

Sensitivity Analysis

A sensitivity scenario was analyzed to evaluate the impact of the proposed Okeechobee plant in conjunction with the proposed New Smyrna Beach plant. Since the 2003 winter system loading is greater than the 2003 summer system loading, the sensitivity analysis focused on the winter system under the Northern FPL dispatch scenario.

One additional pre-contingency benchmark overload, related to the redispatch of the Sanford plant to accommodate New Smyrna Beach, was observed. No additional pre-contingency voltage violations were observed for this sensitivity scenario.

Two of the post-contingency overloads observed in the primary power flow analysis were also observed in this sensitivity analysis. There is, however, no significant difference in system performance with the Okeechobee plant alone or with both the Okeechobee and New Smyrna Beach plants. Several new post-contingency voltage violations were observed, but are likely to be easily mitigated.

The dynamic performance of the sensitivity scenario was first-swing stable with well-damped oscillations for all contingencies with and without the Okeechobee plant. Again, the Turkey Pt. units lost synchronism in response to contingency 10 under benchmark system conditions as well as all Okeechobee dispatch scenarios. Therefore, the addition of the Okeechobee plant has no significant impact on the performance of the Turkey Pt. units in response to this severe contingency.

Conclusion

The Okeechobee plant can be interconnected to the FPL system and deliver power to FPL or other utilities in peninsular Florida with no adverse impact on the transmission reliability of peninsular Florida.

Several minor adverse rating violations were noted which may be simulation artifacts and require further study. If necessary, equipment upgrades or other remedial measures can easily correct these deficiencies.



2. INTRODUCTION

PG&E Generating is proposing to build a new gas-fired power plant near the Sherman 230kV substation in southeastern Florida. The proposed plant will loop into the existing Sherman-Martin 230kV line at a new substation called Okeechobee, which will be located approximately 3 miles south of the Sherman substation. The Okeechobee plant will have a maximum summer power output of 516.5MW and a maximum winter power output of 563.5MW.

PG&E Generating retained GEII's Power System Energy Consulting (PSEC) group to perform a system impact study to evaluate the impact of the Okeechobee plant on power system performance. This study conforms to the criteria specified in the document, *Methodology for Completing a System Impact Study*, which was provided by Hector Sanchez of FPL as Appendix No. 2 to Exhibit 1 to Attachment D in response to a PG&E Generating request dated July 23, 1999. The required study procedure includes the following analyses:

- Load Flow Analysis
- Transient Stability Analysis
- Short Circuit Analysis
- Special Studies, as required

Therefore, power flow, short circuit, PV (power-voltage) and transient stability analyses were performed. The power flow analysis identified branch (e.g., transmission line or transformer) loading and bus voltage violations under both normal and contingency (e.g., single line outage) operating conditions. The short circuit analysis determined the maximum three-phase symmetrical current at the Okeechobee, Sherman and Martin substations, and the PV analysis evaluated the impact of the Okeechobee plant on maximum power transfer capability across the Georgia/Florida interface. Finally, the stability analysis evaluated both first swing stability and system damping for a variety of system conditions and disturbances.

Section 3 of this report describes the study approach in detail. Sections 4 through 7 describe the results of the power flow, short circuit, PV and stability analyses, respectively. Section 8 presents the study conclusions and recommendations.



3. STUDY APPROACH

This study used a relative approach to determine the impact of the proposed Okeechobee plant on the performance of the Florida power system. First, system performance without the plant was determined in order to establish the benchmark, and then system performance with the plant was determined and compared to the benchmark. This relative approach removed any ambiguities as to the actual impact of the proposed plant since existing criteria violations, if any, were identified.

The analyses were performed using PSEC's Positive Sequence Load Flow (PSLF) software package. PSLF is a large-scale database and network solution program for power flow analysis. It also includes the Symmetrical Component Short-Circuit (SCSC) program for fault current calculations and the Positive Sequence Dynamic Simulation (PSDS) program for transient stability analyses.

The following sections describe the benchmark system conditions, Okeechobee dispatch scenarios, as well as the performance criteria and contingency list.

3.1 Benchmark System Conditions

The 2003 FERC 715 summer and winter peak power flow databases were retrieved from the FERC website (www.ferc.com), converted to PSLF format, solved and reviewed. Modifications were made to represent the 2003 transmission network as defined by the Florida Reliability Coordinating Council (FRCC) 1999 Regional Load and Resource Plan (July 1999) and to supply missing transmission line ratings. In addition, the power flow databases were modified to represent the Sanford repowering project as defined by the Florida Power & Light (FPL) Ten Year Site Plan 1999-2008 (April 1999). The Ft. Myers repowering project was already modeled in the FERC databases in accordance with the FPL Ten Year Site Plan.

The FRCC 1999 Regional Load and Resource Plan includes the proposed transmission lines listed in *Table 3-1*. This table shows the proposed in-service date, line name, nominal voltage, estimated line length, as well as the number of circuits modeled in the FERC 715 database. The following selection criteria were used to determine which proposed transmission lines, if any, were not included in the 2003 FERC 715 databases and should, therefore, be added.

To determine the number and location of missing second or third circuits, a comparison of the FRCC plan to the 2003 power flow databases was made. This comparison indicated that a number of proposed lines with in-service dates before January of 2004 were not included in the database. For example, in contrast to the



FRCC plan, the Stanton-Curry Ford 230kV line has only a single circuit in the power flow database. Confirmation of the need for a second line was provided by the FRCC transmission map (March 1999), which indicates a second Stanton-Curry Ford circuit in 2000. Similarly, the two additional Sanford-Poinsett 230kV lines, associated with the Sanford repowering project, were also not included in the database.

To ensure that circuits were not added in error, a second comparison of the FRCC plan with the FRCC transmission map was made. This comparison indicated that many of the proposed transmission lines had line lengths much shorter than the distance between substations. This implies that the proposed lines represented line section upgrades rather than duplicate circuits. For example, a new Broward-Ranch 230kV line is proposed for June of 2000. However, the five-mile line length is significantly less than the distance (approximately 30 miles) between these two substations. Therefore, no changes were made to represent such short line segment upgrades.

By applying the above selection criteria to the FRCC plan, eight transmission lines were added to the 2003 summer power flow database and nine lines were added to the 2003 winter power flow database, as shown in *Table 3-2*. This table lists the added lines, as well as their nominal voltage and line parameters. The modified power flow databases are intended to represent the 2003 system as envisioned in the FRCC plan.

One hundred and fifty nine transmission lines in the FERC 715 power flow databases had zero MVA ratings. In response to the PG&E Generating request for data on July 23, 1999, Mr. Sanchez of FPL provided a database, *fpl_s02.raw*, with the appropriate ratings. The affected lines and the modified line ratings are shown in *Appendix A*.

In the FERC 715 2003 summer database, the Sanford plant was represented by three generating units; the 184MVA Sanford #3 connected via a generator step-up (GSU) transformer to the 115kV system, and the 490MVA units #4 and #5 connected via GSUs to the 230kV system. The total power output was 933MW. Since the second and third Poinsett-Sanford 230kV lines were added to both the summer and winter databases, per the FRCC resource plan, the Sanford plant repowering project was also added to the summer case. To represent this project, three new 255MVA combustion turbine (CT) units were added, for a total plant output of approximately 1470MW. The addition of approximately 535MW required a corresponding dispatch reduction at other generating plants, as shown in *Table 3-3*, using a dispatch priority list provided by PG&E Generating. The Sanford plant network configuration was also modified to match that of the 2003 winter database.



In the FERC 2003 winter database, the Sanford plant was represented by the three existing units noted above, as well as by six new 255MVA CTs, with a total power output of 2017MW. This output level exceeds that shown in the FPL Ten Year Site Plan 1999-2008 (also provided by Mr. Sanchez of FPL), which indicated a Sanford plant winter capacity of 1650MW. Therefore two of the CTs were removed, resulting in a total Sanford power plant output of about 1660MW. The removal of approximately 357MW required a corresponding dispatch increase at other generating plants, as shown in *Table 3-4*. The dispatch increase was implemented at units throughout Florida with power output levels less than their maximum generation capabilities.

One-line diagrams of the power system in the Okeechobee area, illustrating the benchmark summer and winter pre-contingency power flow results, are shown in *Figures 3-1* and *3-2*, respectively.

The dynamic stability data was derived from a Mid Atlantic Area Council (MAAC) System Dynamics Database Working Group (SDDWG) database representing the entire eastern US interconnection for the 2003 summer peak condition. This data was publicly available on the MAAC website, which is accessible via the Pennsylvania-New Jersey Maryland (PJM) Interconnection website (www.pjm.com).

An initial comparison of the dynamics and power flow databases showed that both the bus numbering and bus naming conventions differed. In addition, the SDDWG database included many models not required for the Florida FERC 715 power flow databases. Therefore, significant modifications were required to create a dynamics database consistent with the summer and winter power flow databases.

Additional changes to the power flow databases used by the stability and short circuit analyses included modification of some generator subtransient reactances. Specifically, values of 1pu were changed to a typical value of 0.2pu. Similarly, generator MVA bases that were inconsistent with the generated power (i.e., 100MVA base with 8MW power output) or with the maximum power (i.e. 50MVA base with a 65MW maximum power level) were changed to 110% of either the generated or maximum power.

The dynamic stability load model represented real power loads as constant current and reactive power loads as constant impedance.



Table 3-1. Proposed Transmission Lines from FRCC 1999 Resource Plan

Month/ Year	Line	Nominal Voltage (kV)	LineLength (mi)	Number of Circuits in FERC Database
6/99	Broward-Yamato	230	3	1
6/99	Cape-Indian River	230	2	1
6/99	Greynolds-Laudania	230	3	1
8/99	Andytown-Pennsuco	230	9	1
11/99	Dade-Levee	230	3	2
12/99	Collier-Orange River	230	36	3
6/00	Broward-Ranch	230	5	1
6/00	Flagami-Turkey Point	230	2	2
6/00	Sanford-Volusia	230	6	2
6/00	Stanton-Curry Ford	230	6	1
10/00	Lake Bryan-Intercession City	230	10	2
10/00	Calusa-Ft. Myers	230	2	2
1/01	Duval-Brandy Ranch #1	230	2	1
1/01	Brandy Ranch-Normandy #1	230	10	1
1/01	Duval-Brandy Ranch #2	230	2	1
1/01	Brandy Ranch-Normandy #2	230	10	1
5/01	Ft. Myers-Orange River	230	3	3
6/01	Cane Island-Intercession City	230	3	0
6/01	Broward-Corbett	230	2	1
6/01	Greynolds-Laudania	230	7	1
6/01	Eaton Park	230	10	1
6/01	Barcola-Pebbledale	230	3	1
11/01	Center Park-Forrest	230	5	1
11/01	Forrest-Greenland	230	8	1
11/01	Center Park-Northside	230	11	1
6/02	Poinsett-Sanford #2	230	45	1
6/02	Poinsett-Sanford #3	230	45	1
11/02	Taylor Creek-Holopaw	230	1	1
6/03	Broward-Corbett	230	11	1
6/03	Polk-Lithia	230	28	1
6/03	Lithia-Wheeler	230	11	1
12/03	Lake Bryan-Windermere	230	10	1



Table 3-2. Transmission Lines Added to FERC 715 Power Flow Database.

Line	Nominal Voltage (kV)	Line Parameters		
		R (pu)	X (pu)	B (pu)
Cape-Indian River #2	230	0.0005	0.0039	0.008
Greynolds-Laudania #2 ¹	230	0.001	0.0043	1.232
Stanton-Curry Ford #2	230	0.0012	0.0093	0.0187
Cane Island-Intercession #1	230	0.0016	0.0174	0.0
Barcola-Pebbledale #2	230	0.0008	0.0058	0.0116
Center Park-Northside #2	230	0.0018	0.0155	0.0338
Poinsett-Sanford #2	230	0.0121	0.0847	0.0
Poinsett-Sanford #3	230	0.0121	0.0847	0.0
Lake Bryan-Windermere #1 ²	230	0.0012	0.0138	0.0287

Notes: 1. Line included in FERC 715 power flow with status = 0. Status set to 1.
 2. Line added to winter cases only, since the expected in-service date is 12/2003.

Table 3-3. Generation Redispatch due to Sanford Plant Addition in Summer 2003.

Bus #	Bus Name	Power Output (MW)		
		Pre-Sanford	Post-Sanford	Increment
7904	B BEND 4	442	333.2	108.8
4541	NORTH #2	262	153.2	108.8
11	CU.6	120.4	11.6	108.8
357	PUTN.1CT	134.5	25.7	108.8
2327	DBARY P8	76.8	0	76.8
2328	DBARY P9	76.7	44.7	32
				Total = 544MW



Table 3-4. Generation Redispatch due to Sanford Plant Reduction in Winter 2003.

Bus #	Bus Name	Power Output (MW)		
		Pre-Sanford	Post-Sanford	Increment
7902	B BEND 2	409.2	431	21.8
7911	GANNON 1	114	119	5
7912	GANNON 2	108	118	10
7914	GANNON 4	179	189	10
7940	HARDEE-1	175.5	180	4.5
4516	KCT 5	25.3	54	28.7
4532	NCT #7	177	194.7	17.7
4533	NCT #8	177	194.7	17.7
4534	NCT #9	177	194.7	17.7
4541	NORTH #2	262	288.2	26.2
4553	SSCT #1	177	194.7	17.7
4554	SSCT #2	177	194.7	17.7
11	CU.6	130.9	144	13.1
279	FT.MYER1	147.6	151	3.4
281	MANATEE1	790	819	29
282	MANATEE2	790	819	29
196	MARTIN 2	833	847	14
2640	MULBERRY1	84	84.9	0.9
2665	IC P1&2, "1"	56.1	58	1.9
2665	IC P1&2, "2"	0	33	33
2666	IC P3&4, "1"	56.2	58	1.8
2666	IC P3&4, "2"	55.1	58	2.9
2667	IC P5&6, "1"	56.6	58	1.4
2667	IC P5&6, "2"	56	58	2
2962	OXYCOGN2	16	19.8	3.8
2987	SWN P1&2, "1"	66	67	1
2987	SWN P1&2, "2"	65.8	67	1.2
3300	CR RV G2	476.4	484.5	8.1
3606	BAR P1&2, "2"	55.4	57.8	2.4
3608	PNLRV2	14.8	20	5.2
3734	PASCO RR	23	31.2	8.2

Total = 357MW

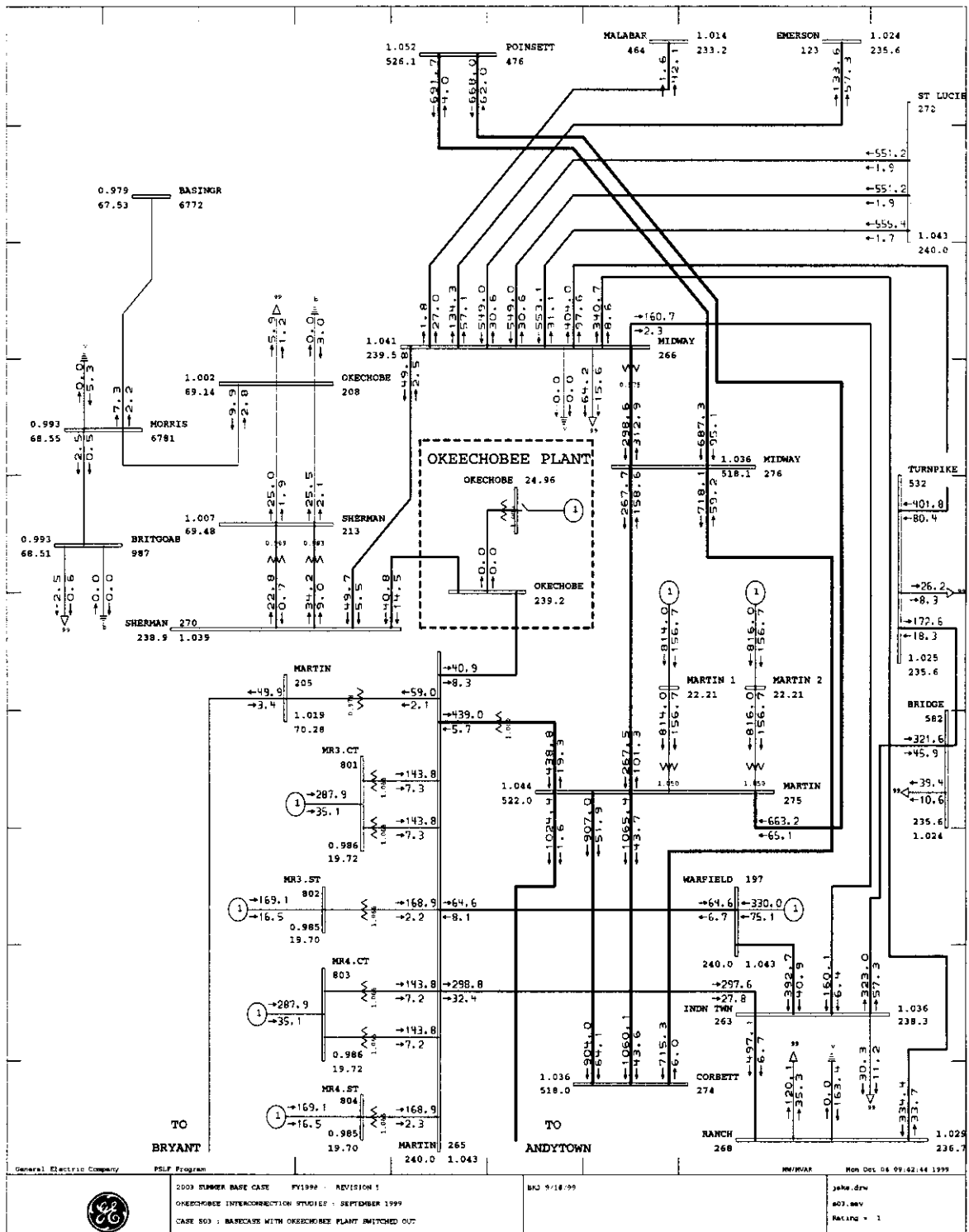

Figure 3-1. 2003 Summer Benchmark Power Flow Results.

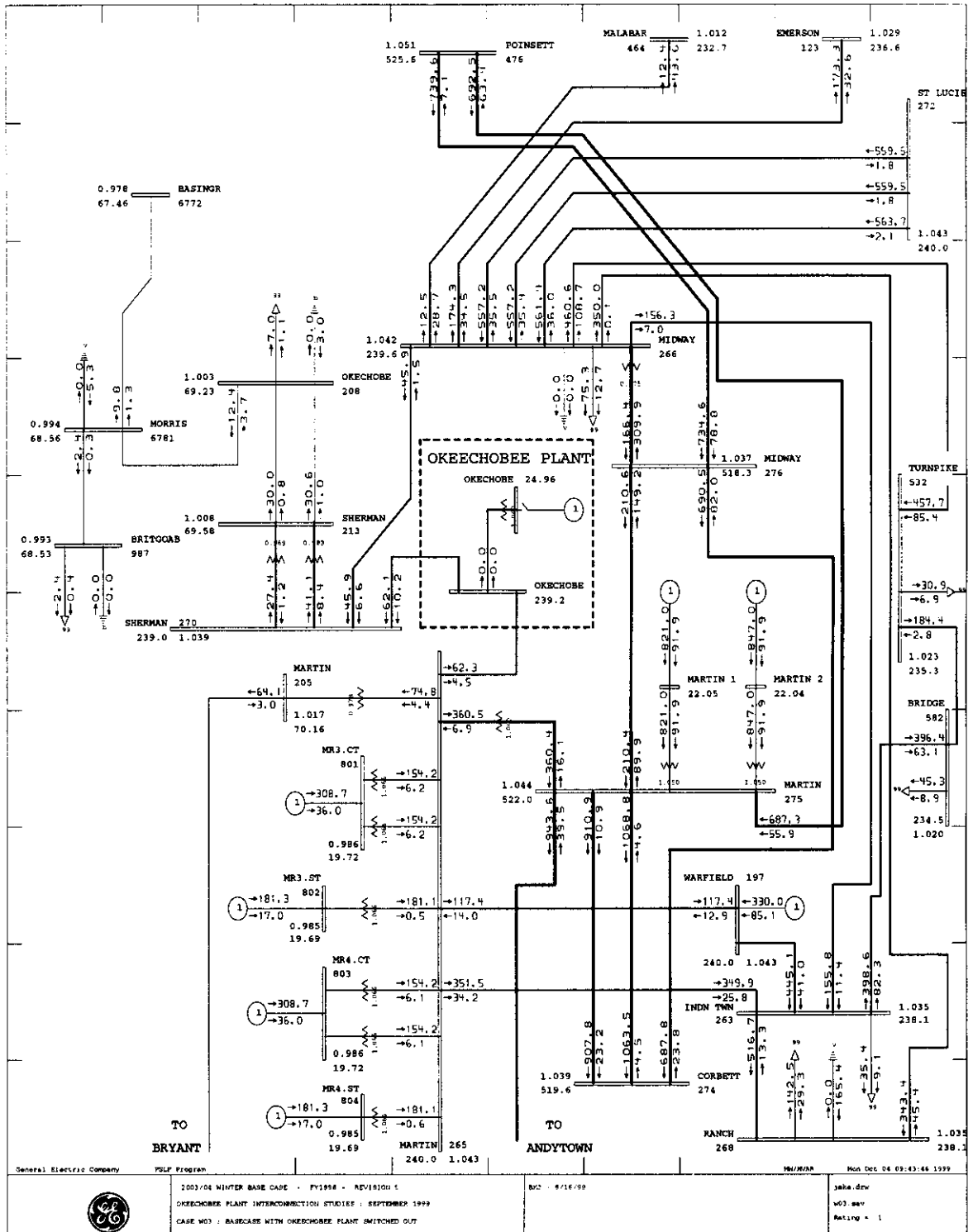

Figure 3-2. 2003 Winter Benchmark Power Flow Results.



3.2 Okeechobee Dispatch Scenarios

The proposed plant will loop into the existing Sherman-Martin 230kV line at a new substation called Okeechobee, which will be located approximately 3 miles south of the Sherman substation. It will have a maximum summer power output of 516.5MW and a maximum winter power output of 563.5MW.

For the Okeechobee plant, the following generator and transformer data were assumed:

- Generator subtransient reactance = 0.2 pu
- Generator MVA = 755 MVA
- Transformer reactance = 0.014pu on 100 MVA
- Transformer resistance = 0.0001pu on 100 MVA
- Transformer FOA Rating = 900 MVA

Block diagrams of the dynamic models used to represent the Okeechobee plant are included in *Appendix B*.

To test the ability of the Okeechobee plant to deliver power throughout Florida, five dispatch scenarios were analyzed under both summer and winter peak load conditions. These scenarios represented power flow from Okeechobee to Tampa Electric Company (TEC), Jacksonville Electric Authority (JEA), Southern FPL, Northern FPL, or Florida Power Corporation (FPC). Each redispatch was implemented using a dispatch priority list provided by PG&E Generating. For most units, the generation decrease was implemented by changing an individual generator's status from 1 to 0. Where noted by an asterisk (*), the generator power was reduced instead of eliminated to better match the total required MW redispatch. The five dispatch scenarios for both the summer and winter cases are summarized in *Tables 3-5 through 3-14*. The difference in system losses was supplied by the system swing bus (60175, ANO U1).

One-line diagrams illustrating the summer and winter pre-contingency power flow results with the Okeechobee plant in-service under each of the above dispatch scenarios are shown in *Figures 3-3 through 3-12*.



Table 3-5. Okeechobee-TEC Summer Dispatch Scenario

Selected Units (Bus Number, "id")	Generation Runback
Big Bend #4 (7904, "1")	333.2 MW
Big Bend #3 (7903, "1")	183.3 MW*
Total = 516.5 MW	

* = Generated power reduced, not eliminated

Table 3-6. Okeechobee-JEA Summer Dispatch Scenario

Selected Units (Bus Number, "id")	Generation Runback
Northside #2 (4541, "1")	153.2 MW
Northside #3 (4542, "1")	363.3 MW*
Total = 516.5 MW	

* = Generated power reduced, not eliminated

Table 3-7. Okeechobee-Southern FPL Summer Dispatch Scenario

Selected Units (Bus Number, "id")	Generation Runback
CU.6 (11, "1")	11.6 MW
Ft. Myers #1 (279, "1")	151.1 MW
Ft. Myers #2 (280, "1")	353.8 MW
Total = 516.5 MW	

* = Generated power reduced, not eliminated

Table 3-8. Okeechobee-Northern FPL Summer Dispatch Scenario

Selected Units (Bus Number, "id")	Generation Runback
Putnam CT #1 (357, "1")	25.7 MW
Putnam ST #1 (359, "1")	64.5 MW*
Cape Canaveral #2 (363, "1")	399.6 MW
Cape Canaveral #1 (362, "1")	26.7 MW*
Total = 516.5 MW	

* = Generated power reduced, not eliminated



Table 3-9. Okeechobee-FPC Summer Dispatch Scenario

Selected Units (Bus Number, "id")	Generation Runback
Debary #9 (2328, "1")	44.7 MW
Debary #2 (2321, "1")	51.8 MW
Debary #1 (2320, "1")	49.9 MW
Crystal River #1 (3299, "1")	369 MW
Total = 515.4 MW	

* = Generated power reduced, not eliminated

Table 3-10. Okeechobee-TEC Winter Dispatch Scenario

Selected Units (Bus Number, "id")	Generation Runback
Σ Sanford Redispatch in TEC	51.3 MW
Big Bend #4 (7904, "1")	417.7 MW*
Hardee-2 #1 (7941, "1")	94.5 MW
Total = 563.5 MW	

* = Generated power reduced, not eliminated

Table 3-11. Okeechobee-JEA Winter Dispatch Scenario

Selected Units (Bus Number, "id")	Generation Runback
Σ Sanford Redispatch in JEA	143.4 MW
Northside #2 (4541, "1")	262 MW
Northside #3 (4542, "1")	158.1 MW*
Total = 563.5 MW	

* = Generated power reduced, not eliminated

Table 3-12. Okeechobee-Southern FPL Winter Dispatch Scenario

Selected Units (Bus Number, "id")	Generation Runback
Σ Sanford Redispatch in Southern FPL	74.5 MW
Cutler #6 (11, "1")	130.9 MW
Pt.Everglade 2 (130, "1")	136.1 MW*
Pt.Everglade 1 (129, "1")	222 MW
Total = 563.5 MW	

* = Generated power reduced, not eliminated



Table 3-13. Okeechobee-Northern FPL Winter Dispatch Scenario

Selected Units (Bus Number, "id")	Generation Runback
Σ Sanford Redispatch in Northern FPL	14 MW
Cape Canaveral #2 (363, "1")	403.8 MW
Cape Canaveral #1 (362, "1")	145.7 MW*
<hr/> Total = 563.5 MW	

Table 3-14. Okeechobee-FPC Winter Dispatch Scenario

Selected Units (Bus Number, "id")	Generation Runback
Σ Sanford Redispatch in FPC	73.8 MW
Debary #1 (2320, "1")	65 MW
Debary #2 (2321, "1")	65 MW
Debary #8 (2327, "1")	99 MW
Debary #9 (2328, "1")	99 MW
Crystal River #1 (3299, "1")	161.7 MW*
<hr/> Total = 563.5 MW	

* = Generated power reduced, not eliminated

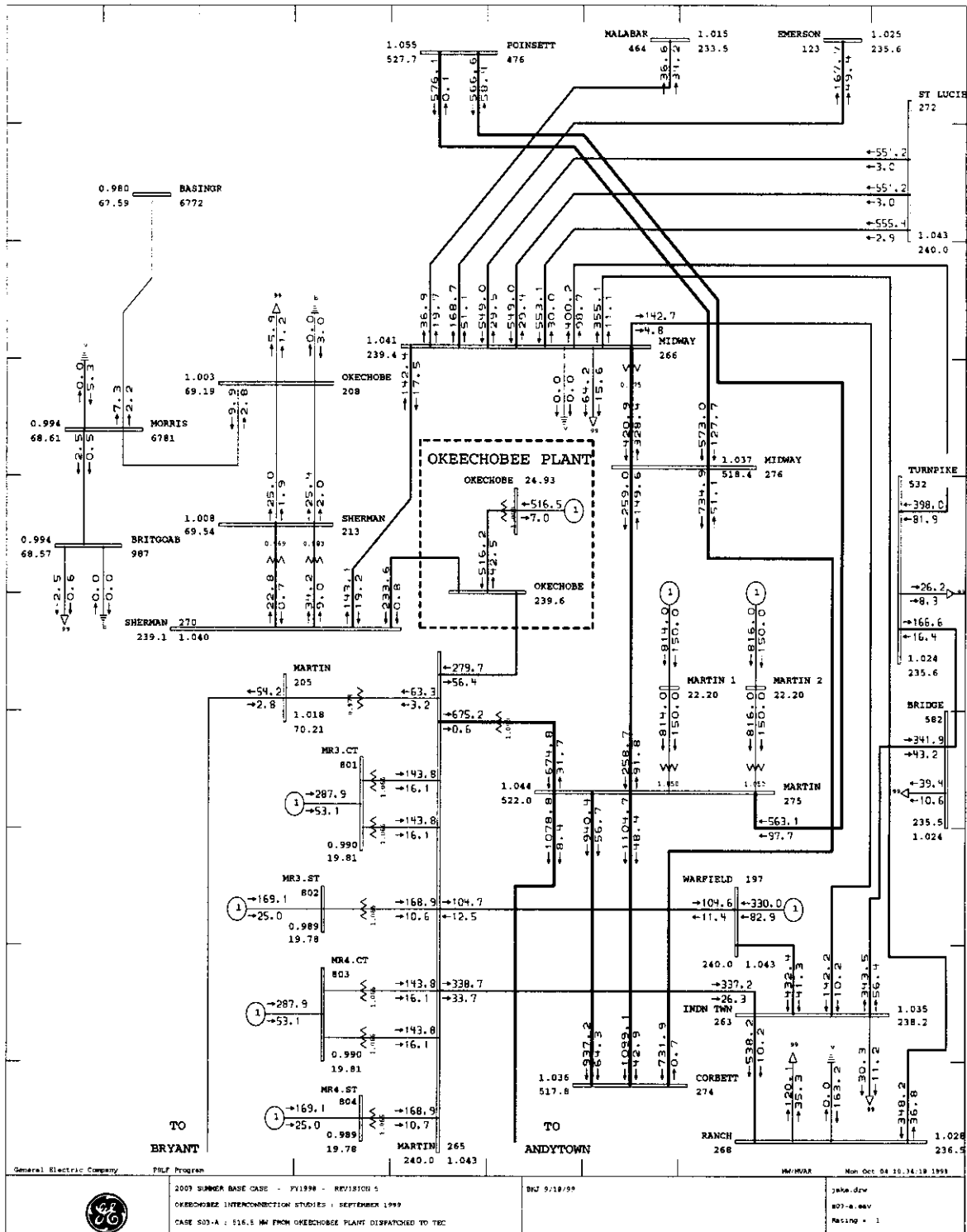

Figure 3-3. 2003 Summer Okeechobee TEC Dispatch Power Flow Results.

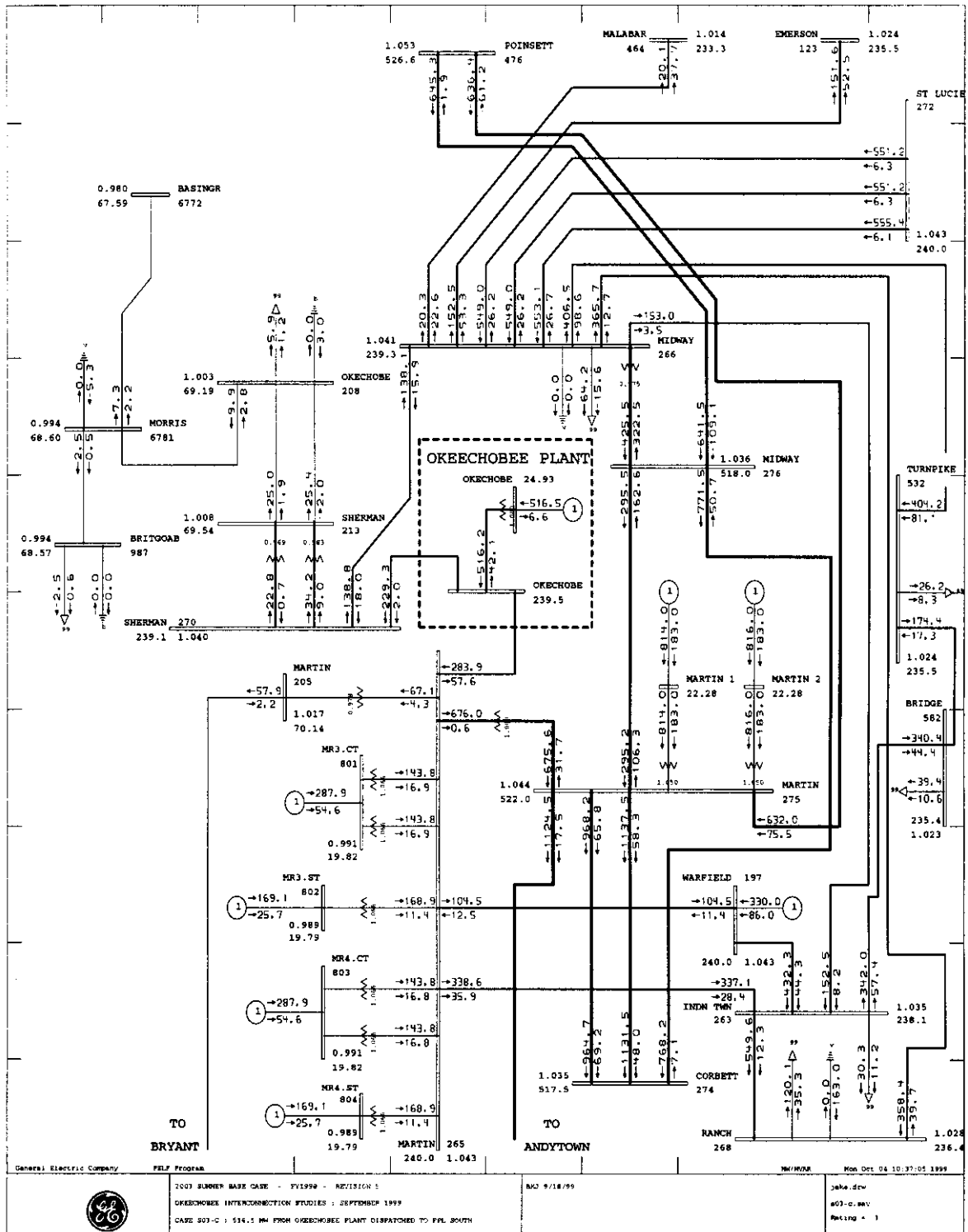

Figure 3-5. 2003 Summer Okeechobee So. FPL Dispatch Power Flow Results.

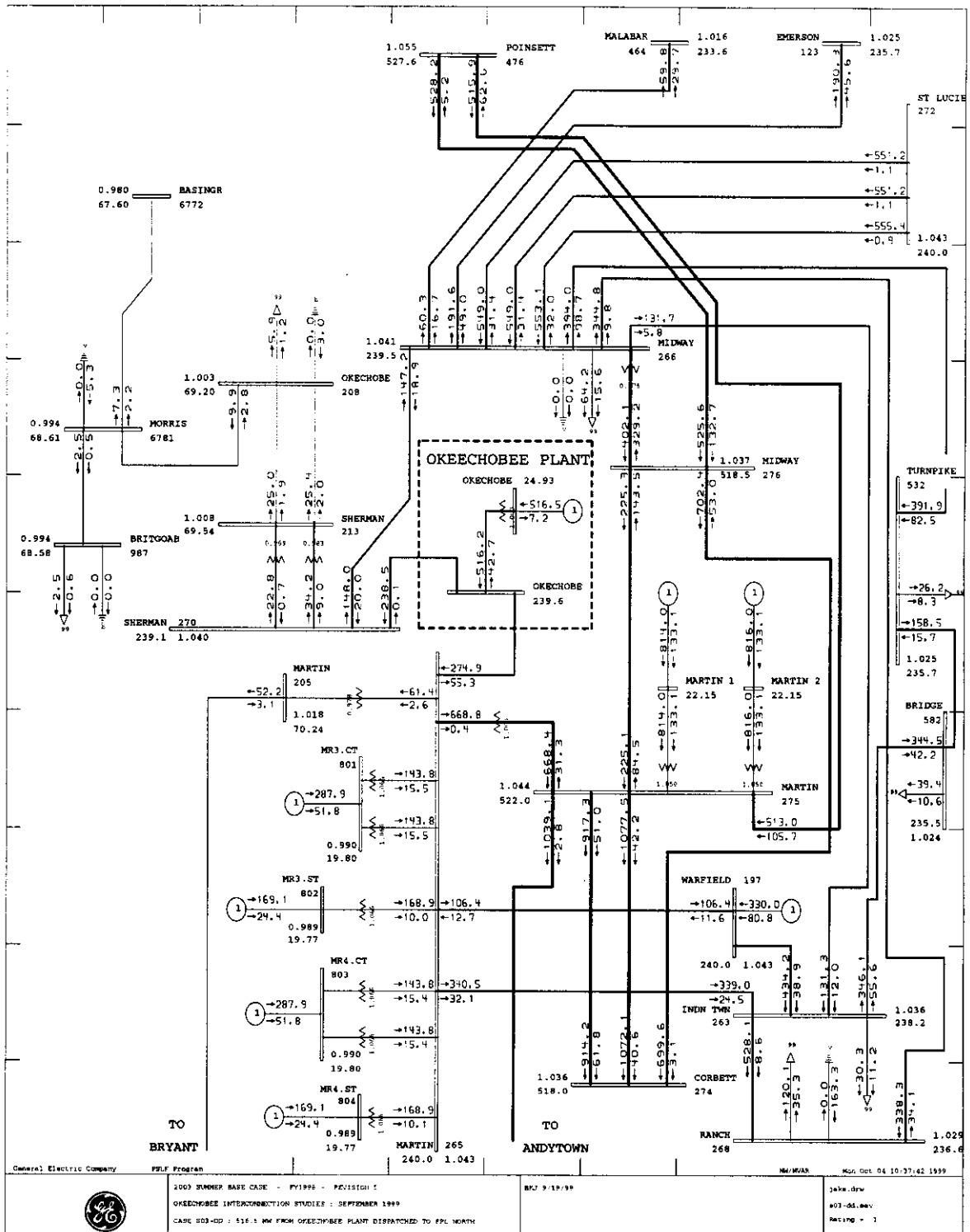

Figure 3-6. 2003 Summer Okeechobee No. FPL Dispatch Power Flow Results.

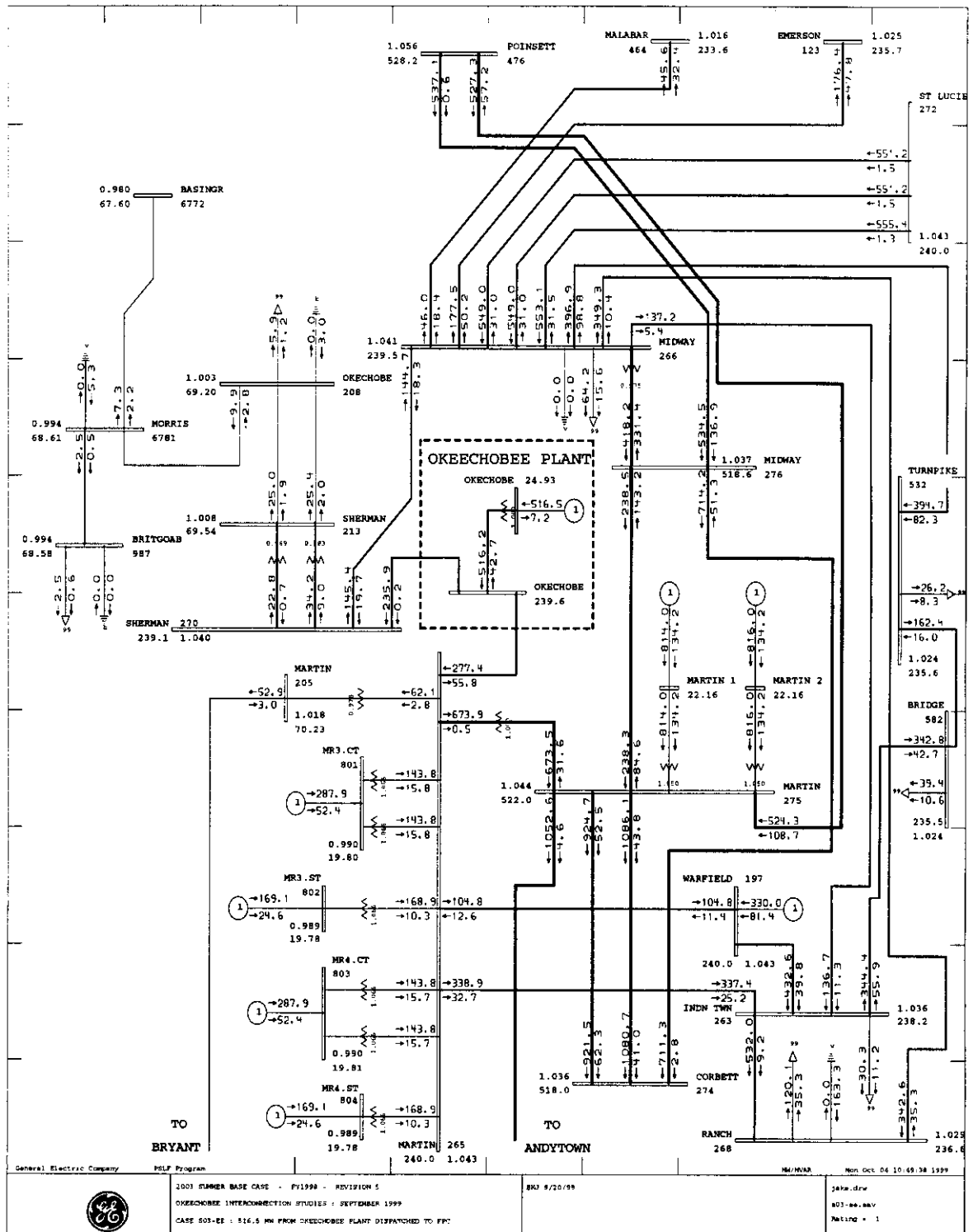

Figure 3-7. 2003 Summer Okeechobee FPC Dispatch Power Flow Results.

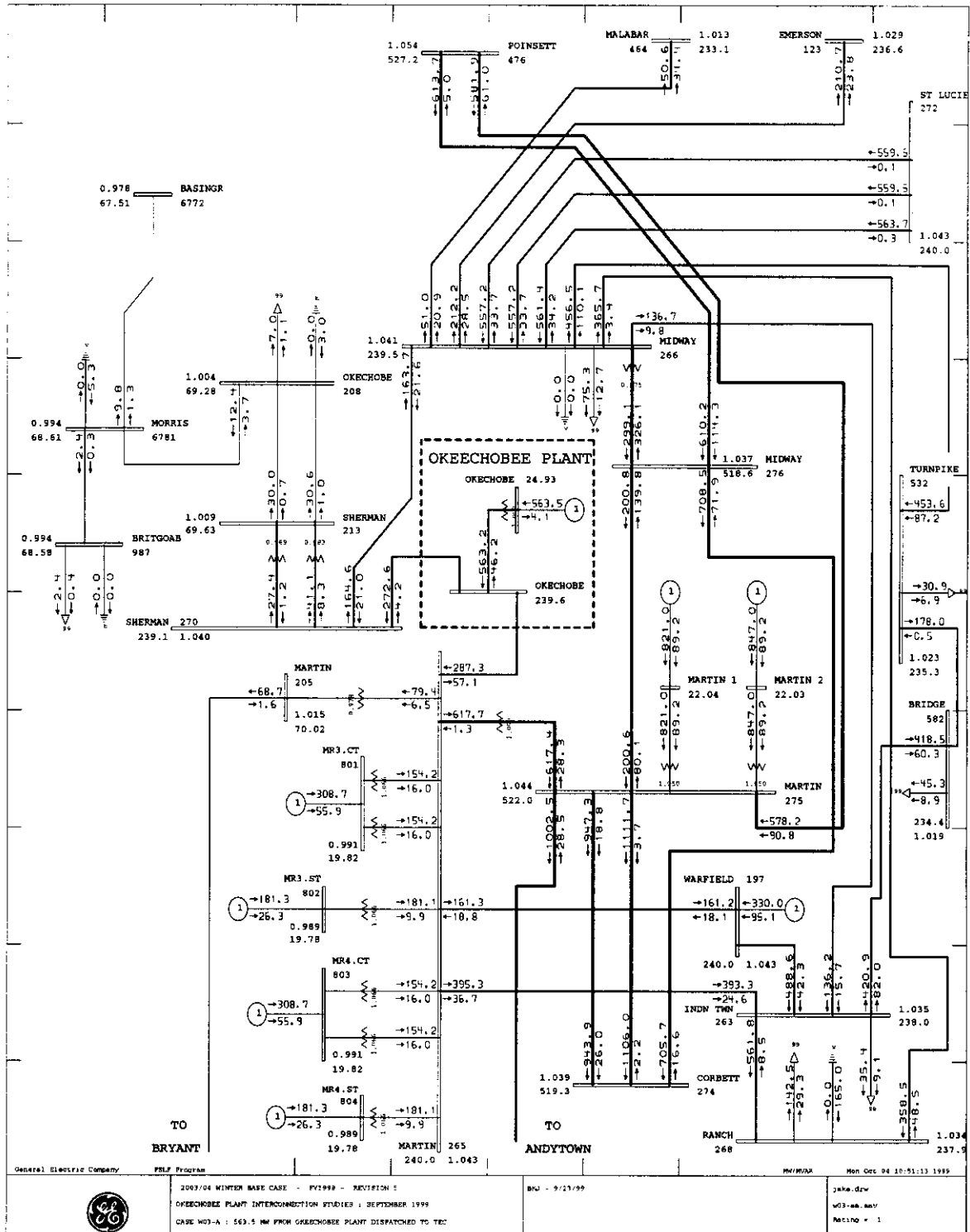

Figure 3-8. 2003 Winter Okeechobee TEC Dispatch Power Flow Results.

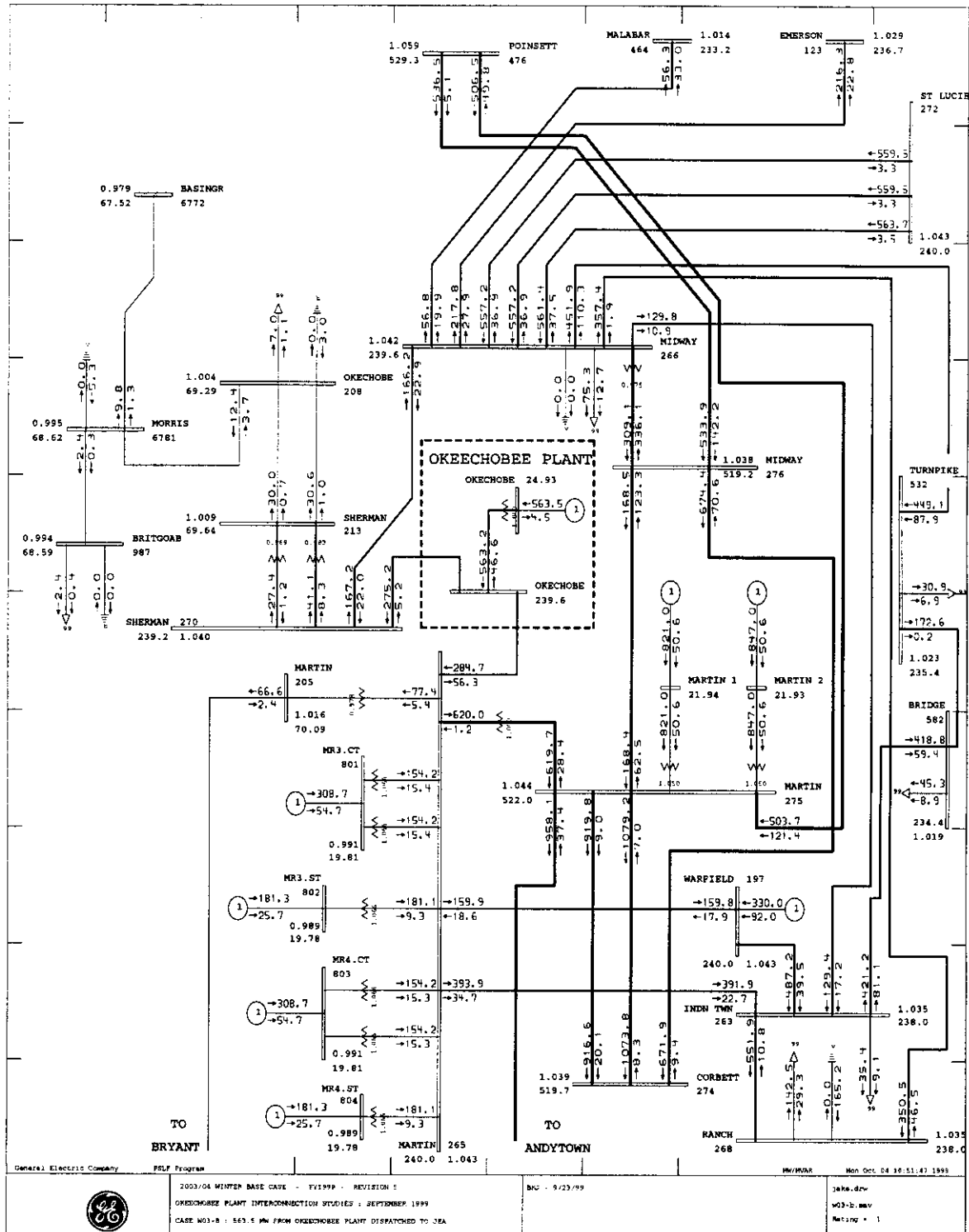

Figure 3-9. 2003 Winter Okeechobee JEA Dispatch Power Flow Results.

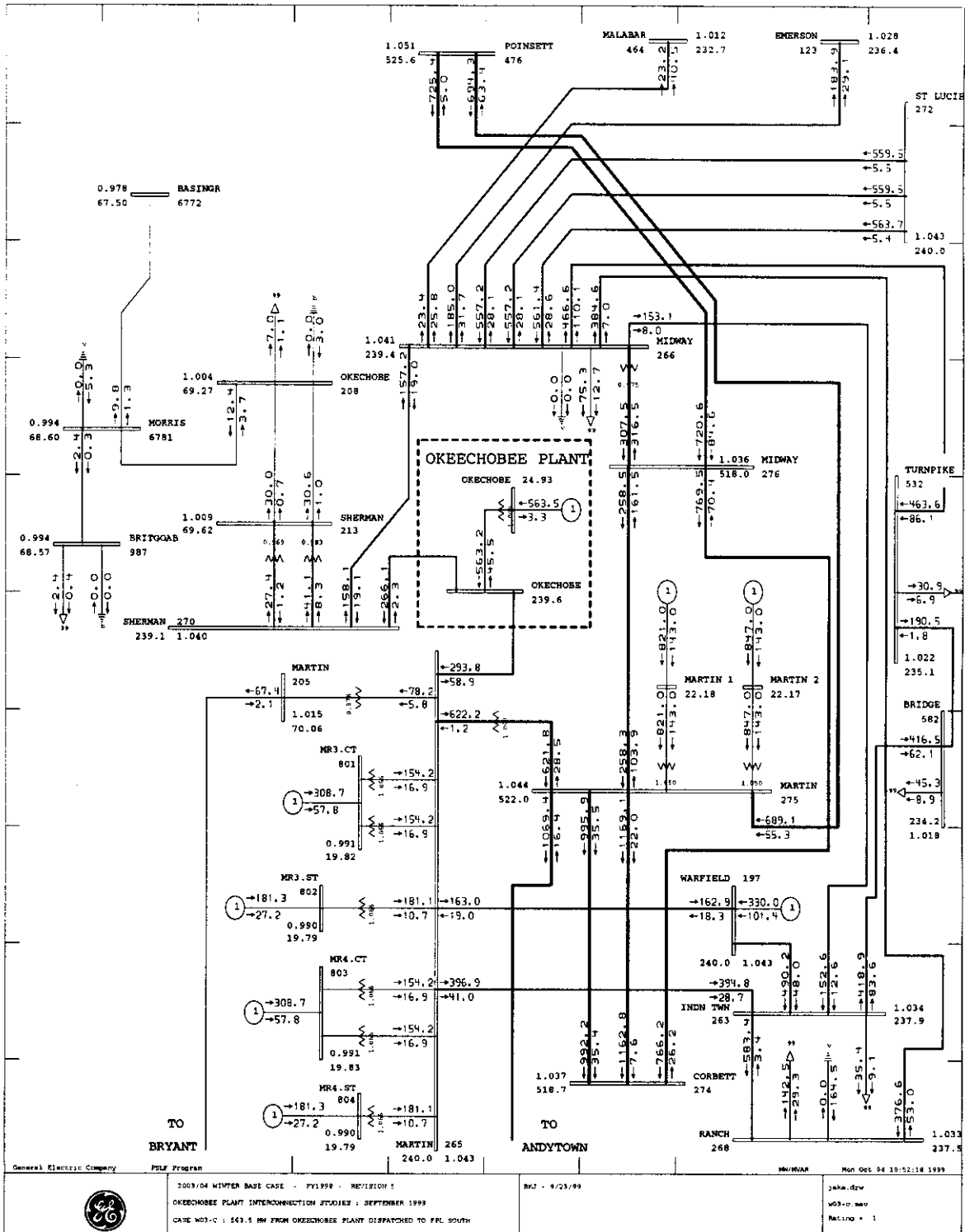

Figure 3-10. 2003 Winter Okeechobee So. FPL Dispatch Power Flow Results.

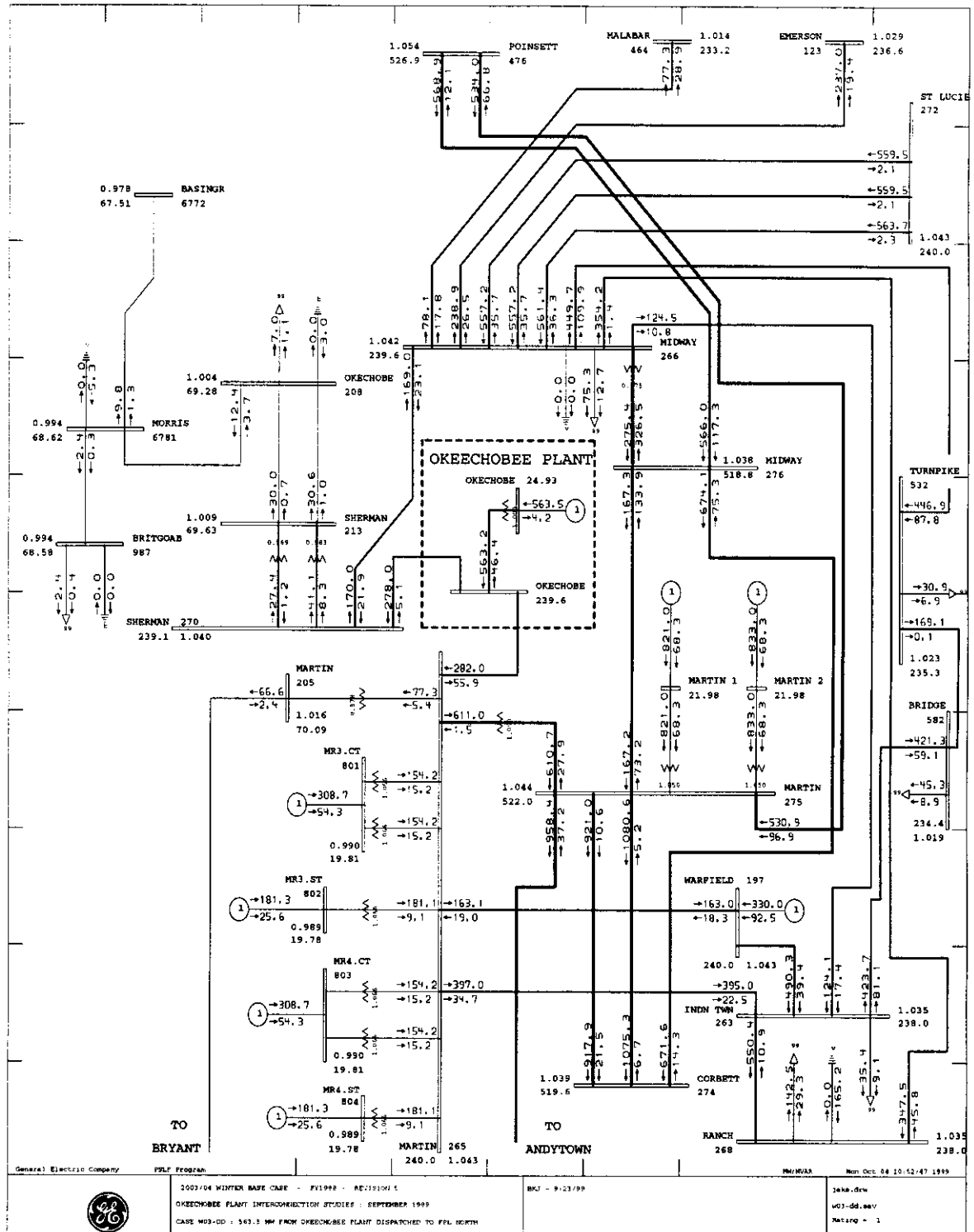

Figure 3-11. 2003 Winter Okeechobee No. FPL Dispatch Power Flow Results.

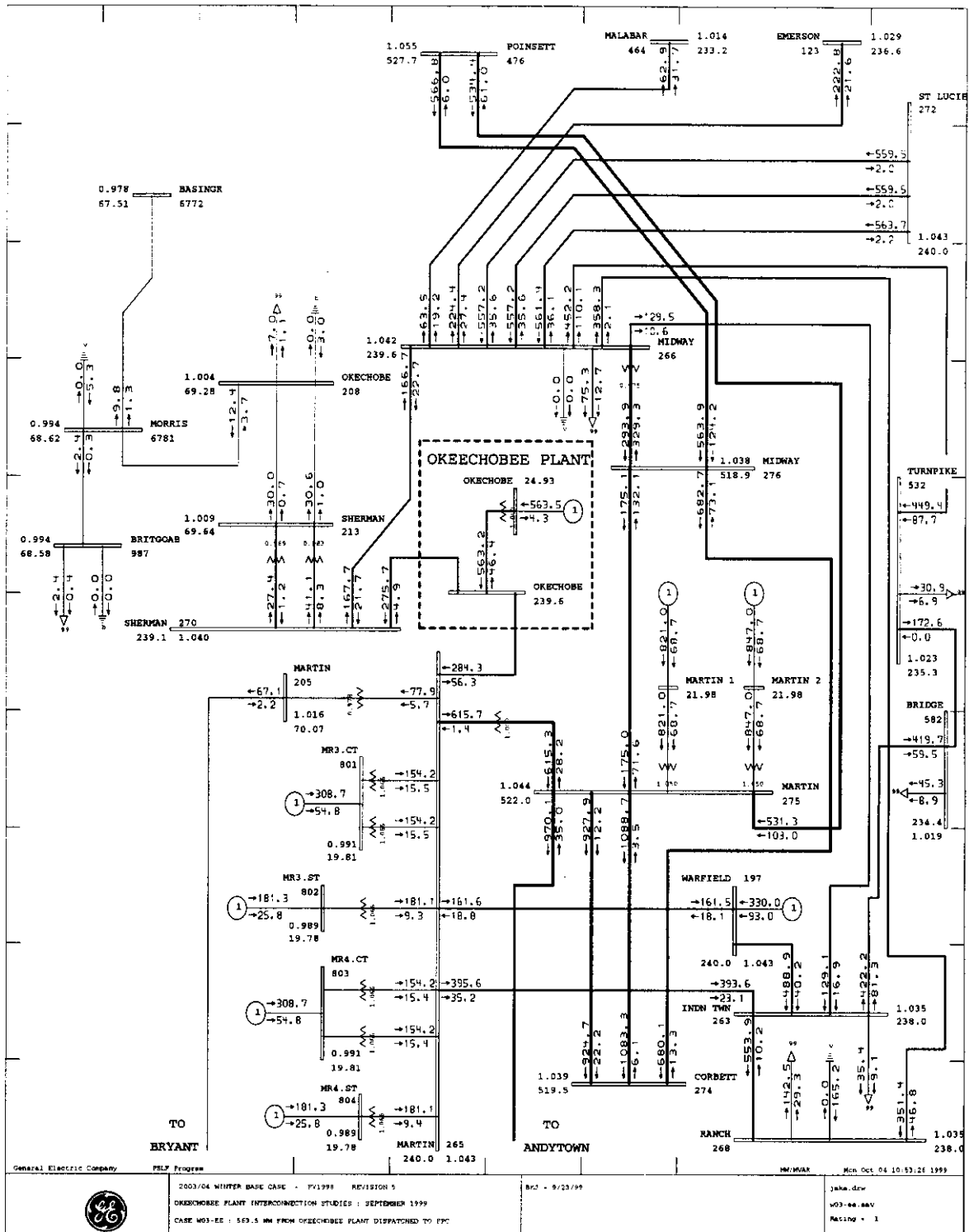

Figure 3-12. 2003 Winter Okeechobee FPC Dispatch Power Flow Results.



3.3 Sensitivity Scenario

A sensitivity scenario was analyzed to evaluate the impact of the proposed Okeechobee plant in conjunction with the proposed New Smyrna Beach plant. Since the 2003 winter system loading is greater than the 2003 summer system loading, the sensitivity analysis focused on the winter system.

The power output of the Sanford plant was reduced to accommodate the addition of the 500MW New Smyrna Beach plant, as shown in *Table 3-15*.

Table 3-15. New Smyrna Beach Dispatch Scenario

Selected Units (Bus Number, "id")	Generation Runback
Sanford #4 CT (781, "3")	179 MW
Sanford #4 CT (781, "2")	179 MW
Sanford #4 CT (781, "1")	142 MW*
Total = 500 MW	

* = Generated power reduced, not eliminated

According to the testimony of Michel P. Armand to the Florida Public Service Commission (Docket No. 981042-EM, September 28, 1998), the addition of the New Smyrna Beach plant also requires reinforcement of the local 115kV network. Specifically, a second Smyrna-Cassadaga 115kV transmission line and a new Cassadaga-Lake Helen 115kV transmission line were required, as shown in *Table 3-16*. This table lists the added lines, as well as their nominal voltage and line parameters.

Table 3-16. New Transmission Lines Associated with the New Smyrna Beach Plant.

Line	Nominal Voltage	Line Parameters		
	(kV)	R (pu)	X (pu)	B (pu)
Smyrna-Cassadaga #2	115	0.01708	0.08369	0.01563
Cassadaga-Lake Helen #1	115	0.00570	0.02790	0.00520

3.4 Performance Criteria

In response to the PG&E Generating request for data on July 23, 1999, Mr. Sanchez provided the FPL planning criteria as well as the *Power Delivery System Facility Rating Methodology* (May, 1999). For the power flow analysis, the same voltage performance criteria were used for normal operation and for contingency operation. Under both conditions, the minimum acceptable voltage is 0.95pu and the maximum acceptable voltage is 1.05pu.

Similarly, the same thermal, or branch loading, performance criteria were used for normal operation and for contingency operation. Under both conditions, acceptable branch loadings are less than 100% of the normal continuous summer



rating (Rate 1 in the power flow). However, FPL uses emergency ratings (Rate 2 in the power flow) for autotransformers.

Impacts due to the proposed plant will be identified as follows:

- Thermal violations that did not occur in the benchmark system.
- Voltage violations, 115kV and above, that did not occur in the benchmark system.

The monitored areas consisted of all Florida areas, as identified in the power flow data base. *Table 3-17* lists the monitored areas.

Table 3-17. Monitored Areas for the Power Flow Analysis.

Zone #	Zone Name	Company
1	FPL	Florida Power & Light
2	FPC	Florida Power Corporation
3	FTP	City of Fort Pierce
4	GVL	Gainesville Regional Utility
5	HST	City of Homestead
6	JEA	Jacksonville Electric Authority
7	KEY	City of Key West
8	KIS	Kissimmee Utility Authority
9	LWU	City of Lake Worth
10	NSB	City of New Smyrna Beach
11	OUC	Orlando Utility Commission
12	SEC	Seminole Electric Cooperative
13	LAK	City of Lakeland
14	STK	City of Starke
15	TAL	City of Tallahassee
16	TEC	Tampa Electric Company
17	FMP	Florida Municipal Power
18	NUG	Non Utility Generator
19	RCU	Reedy Creek Utility

The FPL power flow solution parameters for switched and controlled devices are shown in *Table 3-18* under various system conditions:

Table 3-18. Power Flow Solution Parameters.

Parameter	Pre-Contingency	Post-Contingency (Line Outage)	Post-Contingency (Unit Outage)
Transformer Taps	Adjustable	Locked	Locked
Area Interchange	Locked	Locked	Open
Switched Shunts	Adjustable	Adjustable	Adjustable



3.5 Contingency List

The contingency lists for both the power flow and stability analyses were developed in compliance with the *FRCC Planning Principles and Guides* (September 25, 1996). The power flow contingency list focused on major generating unit or 230kV and 500kV transmission line outages in Florida, including fault scenarios that result in the outage of a single transmission line, transformer, or generating unit. A complete listing and description of the power flow contingencies is included in *Appendix C*.

A subset of the power flow contingencies, representing the worst case scenarios, were used in the PV analysis.

For the transient stability analysis, ten 3-phase fault scenarios were analyzed. The selected fault scenarios resulted in the outage of a single generating unit, a single transmission line, or one line and one generating unit.

Tables 3-19 and 3-20 show the contingency lists used for the PV and stability analyses, respectively.

Table 3-19. Contingency List for PV Analysis.

#	From Bus-To Bus, "ID"	Description
1	3, "1"	Loss of Turkey Pt. unit #3
2	200, "1"	Loss of St. Lucie unit #2



Table 3-20. Contingency List for Stability Analysis

Case	Fault Type and Location				Fault Clearing						
	Type	Name	Voltage	#	Element	From Bus	#	Clear Time	To Bus	#	Clear Time
1	3 ϕ on bus	ST LUCIE ¹	230 kV	272	St. Lucie #1	ST LUCIE	272	5 cycles P ²	STLUCIE1	199	5 cycles P
2	3 ϕ on bus	TURKEY P	230 kV	119	Turkey Pt. #3	TURKEY P	119	5 cycles P	TP.3	3	5 cycles P
3	3 ϕ on bus	SEMINOLE	230 kV	7119	Seminole #1	SEMINOLE	7119	5 cycles P	SEM. 1	7117	5 cycles P
4	3 ϕ on bus	MARTIN	500 kV	275	Martin #2	MARTIN	275	5 cycles P	MARTIN 2	196	5 cycles P
5	3 ϕ on line	DUVAL	500 kV	356	500kV line	DUVAL	356	5 cycles P	8THALMAN	10015	5 cycles P
6	3 ϕ on line	MARTIN	500 kV	275	500kV line	MARTIN	275	5 cycles P	POINSETT	476	5 cycles P
7	3 ϕ on line	OKECHOBE	230 kV	97010	230kV line	OKECHOBE	97010	5 cycles P	SHERMAN	270	5 cycles P
8	3 ϕ on line	OKECHOBE	230 kV	97010	230kV line	OKECHOBE	97010	5 cycles P	MARTIN	265	5 cycles P
9	3 ϕ on bus CB failure	MARTIN	500 kV	275	Martin #2 500kV line	MARTIN MARTIN	275 275	5 cycles P 5 cycle TT	MARTIN 2 POINSETT	196 476	5 cycles P 5 cycle TT
10	3 ϕ on bus CB failure	TURKEY P	230 kV	119	Turkey Pt. #3 230kV line	TURKEY P TURKEY P	119 119	5 cycles P 12 cycle B	TP.3 GALLOWAY	3 945	5 cycles P 12 cycle B

Notes: 1. Table of bus names in load flow

Substation	Name	Number
St. Lucie 230kV	ST LUCIE ¹	272
Turkey Pt. 230kV	TURKEY P	119
Seminole 230kV	SEMINOLE	7119
Martin 500kV	MARTIN	275
Monroe 345kV	DUVAL	356
Martin 230kV	MARTIN	265
Okeechobee 230kV	OKECHOBE	97010
Galloway 230kV	GALLOWAY	945

2. P = primary clearing, B = backup clearing, TT = transfer trip



4. POWER FLOW ANALYSIS

The purpose of this power flow analysis was to determine the impact of the proposed Okeechobee plant on the Florida system by comparing the relative performance of the system with and without the proposed plant. There are two basic conditions under which the transmission system must operate: normal, or all-lines-in; and single contingency conditions. Both were examined.

For pre-contingency solutions, transformer, area interchange, and switched shunt control was allowed. For post-contingency solutions, no control actions were allowed.

The branch loading performance was compared against appropriate criteria. For transmission lines, the normal continuous rating (Rate 1 in the power flow) was applied for both pre-contingency and post-contingency loading. For transformers, the normal continuous rating was used for pre-contingency loading and the emergency rating (Rate 2) was used for post-contingency loading. Note that for many transformers Rate 2 is the same as Rate 1. The voltage performance was compared to an acceptable operating range of 0.95 pu to 1.05 pu for both normal and contingency conditions.

4.1 Pre-contingency Violations

Pre-contingency criteria violations for both the benchmark system and the various Okeechobee plant scenarios are summarized below. Complete pre-contingency power flow results are shown in *Appendix D*.

Under normal system operating conditions with all lines in-service but without the proposed plant, the loading on a number of branches exceeds their normal continuous rating. In *Appendix D, Table D-1* shows the overloaded branches for the summer 2003 benchmark case as well as for each of the Okeechobee dispatch cases. Similarly, *Table D-2* shows overloaded facilities for the winter 2003 power flow cases. In each table, the column labeled "Base Case Flow" contains a list of all overloaded branches for the benchmark case.

A number of pre-contingency voltage violations were also observed in both the 2003 summer and 2003 winter benchmark systems. *Table D-3* shows the pre-contingency voltage violations for the summer benchmark case as well as for each summer Okeechobee dispatch scenario. Similarly, *Table D-4* shows the pre-contingency voltage violations for the winter benchmark case as well as for each winter Okeechobee dispatch scenario.



These tables show that the number and level of violations was largely independent of the Okeechobee dispatch scenarios. In fact, some of the Okeechobee dispatches actually eliminated some of the benchmark violations. Therefore, it can be concluded that any measure taken to remedy the benchmark violations will be equally effective for the Okeechobee dispatches. This reasoning was fundamental to all phases of the study. Thus, only new criteria violations were counted as adverse impacts due to the proposed Okeechobee plant.

No new branch loading violations were observed under any of the Okeechobee dispatch scenarios, as shown in *Tables D-1* and *D-2*.

Table D-3 shows that two new voltage violations were observed for the 2003 summer TEC, JEA, and Southern FPL dispatch scenarios. Similarly, *Table D-4* shows that two new voltage violations were observed for the 2003 winter JEA and FPC dispatch scenarios. These voltage violations were relatively minor in magnitude and likely to be easily mitigated.

4.2 Post-contingency Violations

One hundred forty one contingencies were analyzed to investigate the impact of the Okeechobee plant on the Florida system. A description of each contingency is included in *Appendix C*.

Post-contingency criteria violations for both the benchmark system and the Okeechobee plant scenarios are summarized below. Complete post-contingency power flow results are shown in *Appendix D*.

Without the proposed plant, loadings on a number of branches exceed the normal ratings for a variety of contingencies. Similarly, a number of bus voltages violate the performance criteria. No attempt was made in this study to mitigate these violations. The performance of the system with the Okeechobee plant on-line was measured relative to the performance of the system without the new plant.

4.2.1 Okeechobee Summer Dispatch Scenarios

In *Appendix D*, *Tables D-5* through *Table D-9* show all transmission lines that exceed their normal ratings and all transformers that exceed their emergency ratings for each of the five Okeechobee summer dispatch cases. Each table shows the largest post-contingency Okeechobee dispatch case overload on a particular branch, how many outages resulted in an overload on that branch, the largest post-contingency benchmark overload on that branch, and the benchmark pre-contingency loading on that branch.

The rightmost column on each of these tables indicates the nature of the overload. Since the objective of this study was to compare the performance of the system



with and without the Okeechobee plant, the overloads were grouped into three categories, as follows.

- (1) The branch was overloaded in the pre-contingency benchmark case. Therefore, any post-contingency overloads on this branch for an Okeechobee dispatch scenario were not likely to be a consequence of the new generation.
- (2) The branch was overloaded for at least one post-contingency benchmark simulation. Again, any post-contingency overloads on this branch were not likely to be a consequence of the new generation.
- (3) The branch was not overloaded for any condition in the benchmark simulations. Therefore, these overloads are likely to be a result of the interconnection of the Okeechobee plant and the chosen dispatch scenario.

For the summer 2003 outage simulations, only one category (3) overload was identified as described below.

FPL System Impacts

No additional post-contingency branch loading violations were observed in the FPL system for any of the Okeechobee dispatch scenarios.

Non-FPL System Impacts

The only category (3) overload was observed on the Brookridge 500/230kV transformer in response to the loss of Lake Tarpon-Brookridge 500kV line under the FPC dispatch scenario. The magnitude of this overload was 101% of the emergency rating, which was the same as the normal continuous rating.

It is noted that this apparent adverse impact is relatively minor in magnitude (101%) and occurs for only one dispatch and one contingency. In addition, it may be a local simulation artifact in any of the following areas:

- Normal and emergency ratings,
- Local modeling detail,
- Operating constraints,
- Post-contingency special protection systems.

Detailed examination of this apparent adverse impact is recommended in order to clarify the above points.

Voltage Performance

Several minor post-contingency voltage violations were observed for the 2003 summer JEA and Southern FPL dispatch scenarios, as shown in *Table D-10*. These voltage violations are likely to be easily mitigated.



4.2.2 Okeechobee Winter Dispatch Scenarios

In *Appendix D, Tables D-11 through Table D-15* show all transmission lines that exceed their normal ratings and all transformers that exceed their emergency ratings for each of the five Okeechobee winter dispatch cases. Unlike the 2003 summer results, the interconnection of the Okeechobee plant at the maximum winter power output level of 563.5 MW results in several category (3) overloads. Each overload is described below.

FPL System Impacts

The overloads on the Martin-Okeechobee and Okeechobee-Sherman 230kV lines were each approximately 108% under contingency conditions. Since the rating of the Martin-Sherman 230kV circuit is 502MVA, the loss of either line results in an overload on the other, with an Okeechobee plant output of 563.5MW. Note, the emergency rating for this branch is equal to its normal rating, and the summer rating is equal to its winter rating.

The overloads on the Midway-Citrus and Citrus-Hartman 138kV lines were each approximately 104% under contingency conditions. These lines were overloaded for four of the five Okeechobee dispatch cases in response to the loss of the Emerson 230/138kV transformer. The addition of the new Okeechobee generation causes a 35MW increase in the power transfer from Midway 230kV to Emerson 230kV. Therefore, the loss of the Emerson transformer results in an increased flow from Midway 230kV to Midway 138kV and across the Citrus bus to the Emerson 138kV bus.

For the 2003 winter benchmark system, the Emerson 230/138kV outage resulted in a 98% loading on the Midway-Citrus-Hartman 138kV line, compared to 104% for the four Okeechobee dispatch cases. No overload was observed on these branches for the Southern FPL dispatch scenario.

The overload on the Harbor-Punta Tap 138kV line was 103% in response to a Manatee unit outage for the TEC dispatch scenario. This dispatch resulted in reduced north to south power transfers through Fort Myers, on both the 138kV and 230kV systems. The 138kV system was not as highly loaded in the benchmark system, and therefore no post-contingency benchmark overloads were observed.

Non-FPL System Impacts

The overload on the Mulb-S-Sandhl-W 69kV line was 105% following a Crystal River-Brookridge 500kV line outage for the TEC dispatch case. With increased imports into the TEC area, loss of this 500kV tie to the north results in increased flows from the east, which appear to be driving this 69kV overload.

The overload on the River-S 230/69kV transformer was 102%, under both the JEA and FPC dispatch cases, following an outage of the Crystal River-Brookridge



500kV line. In the benchmark case, the loading on this transformer was 99.8% of its emergency rating for this outage. The Okeechobee dispatches to JEA and FPC caused a small incremental flow across the transformer, resulting in the marginal overload condition following this one contingency.

The overload on the Hydepk-N–Matz-N T 69kV line was 101%, under the FPC dispatch scenario, following an outage of the Crystal River–Brookridge 500kV line. In the benchmark case, the loading on this line was 97% of its normal rating for this outage. The Okeechobee dispatch to FPC causes a small incremental flow through the TEC system from the east, resulting in the marginal overload condition following this one contingency.

The overload on the Big Bend #1 230/24kV transformer was observed in response to the loss of Brookridge–Crystal River 500kV line for two Okeechobee dispatch scenarios (TEC and Southern FPL). The magnitude of this overload was 101% of the emergency rating in each case. Note that the emergency rating was the same as the normal continuous rating.

As with the summer results, it is noted that these apparent adverse impacts are relatively minor in magnitude ($\leq 108\%$) and each occurs for only one of the 141 contingencies studied. They may also be simulation artifacts, as described in the previous section. Detailed examination of these apparent adverse impacts is recommended in order to clarify the above points.

Voltage Performance

A number of minor post-contingency voltage violations were observed for the 2003 winter TEC and JEA dispatch scenarios, as shown in *Table D-16*. These voltage violations are likely to be easily mitigated.

4.3 New Smyrna Beach Sensitivity Scenario

A sensitivity scenario was analyzed to evaluate the impact of the proposed Okeechobee plant in conjunction with the proposed New Smyrna Beach plant. For this sensitivity case, the New Smyrna Beach plant output was 500MW and the selected Okeechobee dispatch was Northern FPL.

In *Appendix D*, *Table D-17* shows the pre-contingency branch overloads for the 2003 winter benchmark case as well as the two New Smyrna Beach cases (with and without the proposed Okeechobee plant). Similarly, *Table D-18* shows the pre-contingency voltage violations for all three scenarios.

One additional pre-contingency overload was observed on a Sanford 115/18kV transformer, and was due to the redispatch of Sanford to accommodate New Smyrna Beach. No additional pre-contingency voltage violations were observed.



Table D-19 shows the post-contingency branch loading results for this sensitivity case. Two of the post-contingency overloads observed in the primary power flow analysis were also observed in this sensitivity analysis, as described below.

FPL System Impacts

As before, the overloads on the Martin-Okeechobee and Okeechobee-Sherman 230kV lines were each approximately 108%. Since the rating of the Martin-Sherman 230kV circuit is 502MVA, the loss of either line results in an overload on the other, with an Okeechobee plant output of 563.5MW.

The overloads on the Midway-Citrus and Citrus-Hartman 138kV lines were again approximately 104% in response to the loss of the Emerson 230/138kV transformer.

There is no significant difference in system performance with the Okeechobee plant alone or with both the Okeechobee and New Smyrna Beach plants.

Non-FPL System Impacts

No new post-contingency overloads were observed outside FPL territory for this sensitivity scenario.

Voltage Performance

A number of minor post-contingency voltage violations were observed for this sensitivity case, as shown in Table D-20. These voltage violations are likely to be easily mitigated.



5. SHORT CIRCUIT ANALYSIS

A short circuit analysis of the Sherman 230kV, Martin 230kV, and Martin 500kV buses was performed to determine the impact of the proposed plant on existing circuit breaker fault duties. This consisted of the application of a 3-phase bolted fault to the selected buses with the Okeechobee plant out-of-service, followed by a repetition of the faults with the Okeechobee plant in-service. In all cases, the Okeechobee machine rating was 755MVA, the impedance was 0.2pu on the generator's rating, and the connection was through a transformer with a 0.014pu reactance (on 100MVA).

The short circuit results are summarized in *Table 5-1* for 2003 summer conditions. Assuming that the existing circuit breakers have a maximum symmetrical current rating of 50kA, neither the 230kV nor the 500kV circuit breaker ratings will be exceeded with the proposed plant in-service.

Table 5-1
Three-Phase Symmetrical Short Circuit Currents.

Faulted Bus	Without Okeechobee Plant (kA)	With Okeechobee Plant (kA)
Sherman 230kV	12,687	16,756
Martin 230kV	43,057	45,991
Martin 500kV	28,133	28,854



6. PV ANALYSIS

A PV screening analysis was performed to evaluate the impact of the proposed plant on the existing interface power transfer limits. The analysis focused on the impact of an increase in power transfer from the SERC region on the Florida 500kV and 230kV bus voltages. First, system performance without the proposed Okeechobee plant was determined in order to establish the benchmark, and then system performance with the plant was determined and compared to the benchmark.

The starting point for the benchmark PV analysis was the 2003 benchmark summer power flow as defined in Section 3. The lines which constitute the Georgia/Florida interface are shown in *Table 6-1*.

Table 6-1. Definition of Georgia/Florida Interface.

Line	Nominal Voltage
Hatch-Duval	500kV
Thalman-Duval	500kV
Kingsland-Yulee	230kV
So Bainbridge-Sub 20	230kV
Sterling-Suwanee	230kV
Callaway-Port St. Joe	230kV
Scholz-Woodruff	115kV
Twin Lakes-Suwanee	115kV
Wghtchp-Jasper	115kV
Tarver-Jasper	115kV

The increase in power flow across the Georgia/Florida interface was implemented by increasing the power generated at large generating plants outside Florida and decreasing the power generated at the Port Everglades and Lauderdale plants. The power increase was distributed equally among the plants listed in *Table 6-2*.

The power decrease was implemented on the Port Everglades and Lauderdale units in the order shown in *Table 6-3*. As the power output is reduced on an individual generator, the maximum reactive power limit is unchanged. However, the generator status is set to zero when the power output reaches zero to ensure that the reactive output is also zero.



Table 6-2. *Generating Units Outside Florida used in PV Analysis.*

Bus Number	ID	Generating Unit
16461	1	Farley #1
16462	2	Farley #2
16001	1	Vogle #1
16002	2	Vogle #2
16011		Hatch #1
16012	2	Hatch #2
16021	1	Bowen #1
16022	2	Bowen #2
16023	3	Bowen #3
16024	4	Bowen #4
16031	1	Wansley #1
16032	2	Wansley #2
16054	4	Hammond #4
16081	1	Scherer #1
16082	2	Scherer #2
16083	3	Scherer #3
16084	4	Scherer #4
16401	1	Miller #1
16402	2	Miller #2
16403	3	Miller #3
16404	4	Miller #4
16410	1	Gorgas #1
16415	5	Gaston #5
16475	5	Barry #5
16707	7	Crist #7

Table 6-3. *Unit Order for Power Decrease in PV Analysis.*

Bus Number	ID	Generating Unit	Initial P
129	1	Port Everglades #1	222 MW
130	1	Port Everglades #2	223 MW
131	1	Port Everglades #3	406 MW
132	1	Port Everglades #4	411 MW
127	1	Lauderdale ST #4	152 MW
128	1	Lauderdale ST #5	152 MW
133	1	Lauderdale CT #4	323 MW
134	1	Lauderdale CT #5	323 MW

Figure 6-1 shows the results of the benchmark PV simulations, for the summer 2003 system. The solid line represents the normal operating condition with all lines in-service, the dotted line represents the loss of Turkey Pt. unit #3, and the dashed-dotted line represents the loss of St. Lucie unit #2. As expected, the voltage collapse for the contingency cases occurs at a lower level of Georgia/Florida interface flow. The maximum interface flow is approximately 3650MW for the Turkey Pt. outage, and 3500MW for the St. Lucie outage.



Figure 6-2 shows the results of the PV simulations, for the summer 2003 with the Okeechobee plant dispatched against Southern FPL. Again, the voltages with all lines in-service are acceptable throughout the simulation. For the contingency cases, the voltage collapse occurs at a Georgia/Florida interface flow of approximately 3650MW for the Turkey Pt. outage, and 3500MW for the St. Lucie outage.

This screening analysis indicates that the Okeechobee plant has negligible impact on the PV performance of the Georgia/Florida interface.

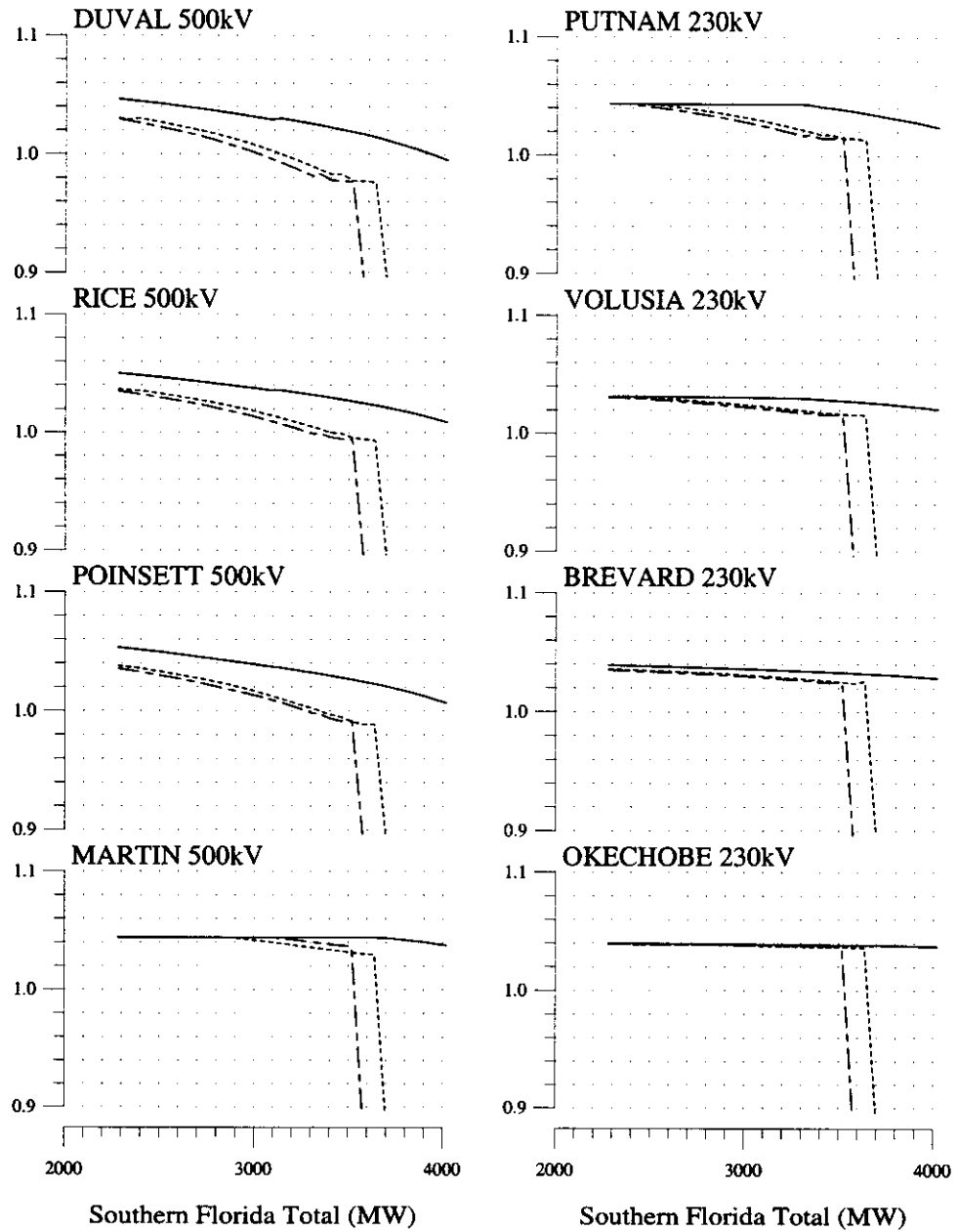

Figure 6-1. PV Results for 2003 Summer Benchmark System.

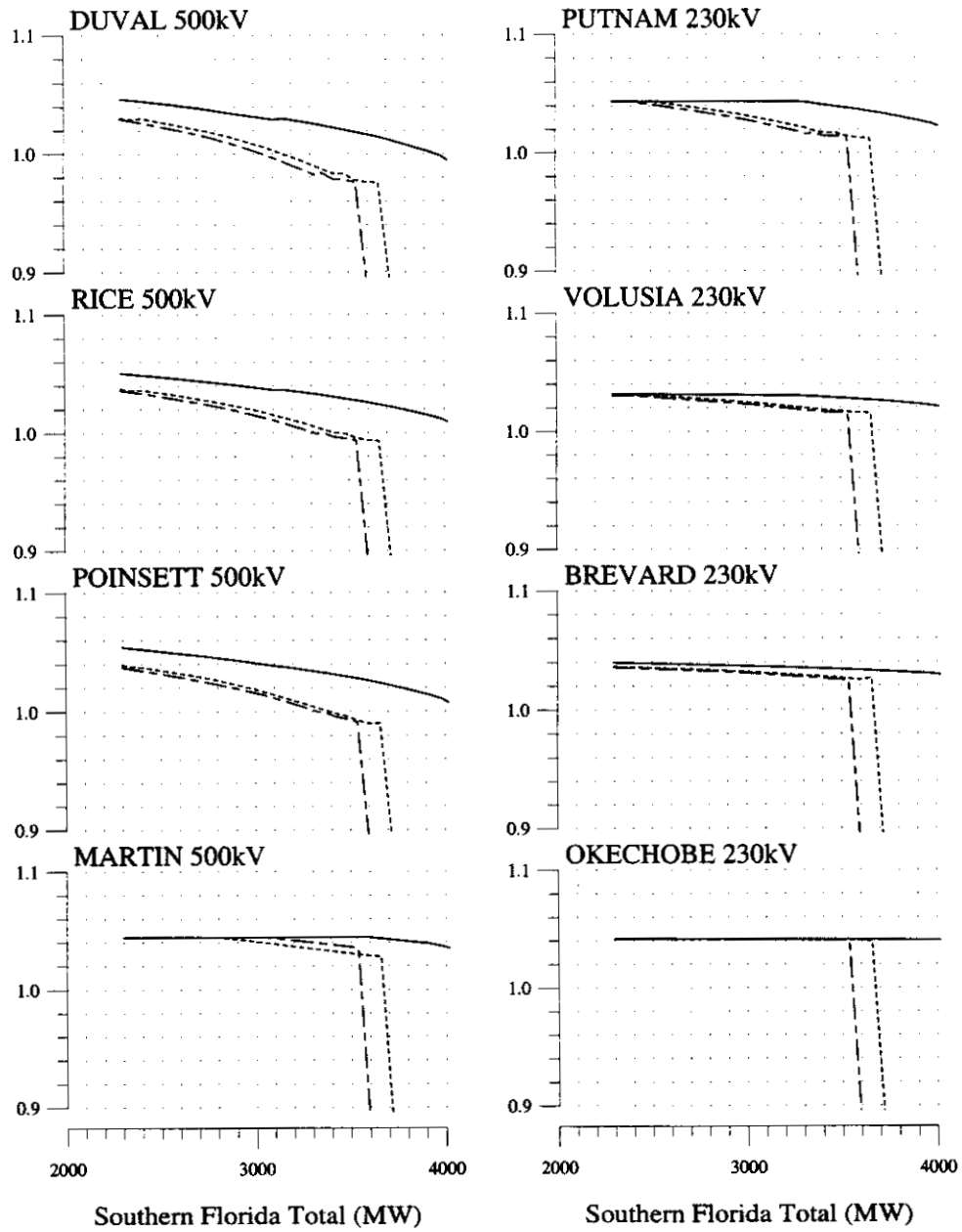

Figure 6-2. PV Results for 2003 Summer Okeechobee Southern FPL Dispatch.



7. STABILITY ANALYSIS

The stability analysis was designed to evaluate the impact of the Okeechobee plant by focusing on the relative performance of the power system with and without the proposed plant. The benchmark performance was established by the results of stability simulations without the plant for both the 2003 summer and winter system conditions. The relative performance of the system with the Okeechobee plant, under each of the test dispatch scenarios, was then compared to these benchmarks.

7.1 Okeechobee Dispatch Scenarios

A summary of system performance with and without the proposed plant is shown in *Tables 7-1* and *7-2* for the summer and winter scenarios, respectively. A complete set of system variables is plotted for each contingency and shown in *Appendix E*. These plots include Okeechobee machine variables, selected Florida machine angles, selected Florida 500kV and 230kV bus voltages as well as real and reactive power flow across three interfaces. The Georgia/Florida interface was defined in *Table 6-1* of the previous section. Two other interfaces were also monitored for the stability analysis. One interface, identified as the Georgia/Florida 500kV interface, is a subset of the full Georgia/Florida interface. It consisted of the Hatch-Duval and Thalman-Duval 500kV lines. A third interface, identified as the Central/Southeast interface, consisted of the Malabar-Emerson and Malabar-Midway 230kV lines as well as the Poinsett-Martin and Poinsett-Midway 500kV lines. All plots in *Appendix E* show the system performance with the proposed plant as a solid line and the benchmark system with a dotted line.

Under the 2003 summer and winter system conditions, the system response for the first nine contingencies is first-swing stable with well-damped oscillations for the benchmark cases as well as all Okeechobee dispatch scenarios. In addition, all generating units maintain synchronism with the system.

Under all scenarios, system performance in response to contingency 10 (3-phase fault at Turkey Pt. 230kV bus, 5-cycle tripping of Turkey Pt. #3, 12-cycle backup tripping of Turkey Pt.-Galloway 230kV line) is both first-swing stable and well-damped. However, the three other Turkey Pt. units lose synchronism in all cases. These units are tripped when the change in machine angle exceeds 180deg and the machine speed exceeds 1.07pu. The addition of the Okeechobee plant has no significant impact on the performance of the Turkey Pt. units in response to this severe contingency.



Table 7-1. Transient Stability Analysis Results for Summer 2003.

Contingency	Benchmark	With Okeechobee Plant				
		TEC Dispatch	JEA Dispatch	So FPL Dispatch	No FPL Dispatch	FPC Dispatch
1	Stable	Stable	Stable	Stable	Stable	Stable
2	Stable	Stable	Stable	Stable	Stable	Stable
3	Stable	Stable	Stable	Stable	Stable	Stable
4	Stable	Stable	Stable	Stable	Stable	Stable
5	Stable	Stable	Stable	Stable	Stable	Stable
6	Stable	Stable	Stable	Stable	Stable	Stable
7	Stable	Stable	Stable	Stable	Stable	Stable
8	Stable	Stable	Stable	Stable	Stable	Stable
9	Stable	Stable	Stable	Stable	Stable	Stable
10	Stable	Stable	Stable	Stable	Stable	Stable

*: Turkey Point units #1, #2 and #4 lose synchronism and are tripped for all scenarios.

Table 7-2. Transient Stability Analysis Results for Winter 2003.

Contingency	Benchmark	With Okeechobee Plant				
		TEC Dispatch	JEA Dispatch	So FPL Dispatch	No FPL Dispatch	FPC Dispatch
1	Stable	Stable	Stable	Stable	Stable	Stable
2	Stable	Stable	Stable	Stable	Stable	Stable
3	Stable	Stable	Stable	Stable	Stable	Stable
4	Stable	Stable	Stable	Stable	Stable	Stable
5	Stable	Stable	Stable	Stable	Stable	Stable
6	Stable	Stable	Stable	Stable	Stable	Stable
7	Stable	Stable	Stable	Stable	Stable	Stable
8	Stable	Stable	Stable	Stable	Stable	Stable
9	Stable	Stable	Stable	Stable	Stable	Stable
10*	Stable	Stable	Stable	Stable	Stable	Stable

*: Turkey Point units #1, #2 and #4 lose synchronism and are tripped for all scenarios.

7.2 Sensitivity Analysis

A sensitivity scenario was analyzed to evaluate the impact of the proposed Okeechobee plant in conjunction with the proposed New Smyrna Beach plant. Since the 2003 winter system loading is greater than the 2003 summer system loading, the sensitivity analysis focused on the winter system.

A summary of system performance with and without the proposed plant is shown in *Table 7-3*. A complete set of system variables is plotted for each contingency and shown in *Appendix E*. These plots show the system performance with the proposed plant as a solid line and the benchmark system with a dotted line.

Under the 2003 winter system conditions, the system response for the first nine contingencies is first-swing stable with well-damped oscillations for all scenarios. In addition, all generating units maintain synchronism with the system.

Again, the system performance of all scenarios in response to contingency 10 (3-



phase fault at Turkey Pt. 230kV bus, 5-cycle tripping of Turkey Pt. #3, 12-cycle backup tripping of Turkey Pt.-Galloway 230kV line) is both first-swing stable and well-damped. However, three Turkey Pt. units lose synchronism. These units are tripped when the change in machine angle exceeds 180deg and the machine speed exceeds 1.07pu. The addition of the Okeechobee plant has no significant impact on the performance of the Turkey Pt. units in response to this severe contingency.

Table 7-3. Sensitivity Analysis Results for Winter 2003.

Contingency	500MW New Smyrna Beach Plant In-Service	
	Benchmark	With Okeechobee Plant
1	Stable	Stable
2	Stable	Stable
3	Stable	Stable
4	Stable	Stable
5	Stable	Stable
6	Stable	Stable
7	Stable	Stable
8	Stable	Stable
9	Stable	Stable
10	Stable*	Stable*

*: Turkey Point units #1, #2 and #4 lose synchronism and are tripped.



8. CONCLUSIONS AND RECOMMENDATIONS

The objective of this study was to determine the potential impact of the proposed Okeechobee plant on the Florida power system. In compliance with the *Form of System Impact Study Agreement* provided by FPL as Exhibit 1 to Attachment D in response to a PG&E Generating request dated July 23, 1999 and the FRCC's *Planning Principles and Guides*, this study focused on the reliability of the FPL system and the peninsular Florida bulk transmission system (voltage levels > 115kV).

Power flow, short circuit, PV (power-voltage) and transient stability analyses were performed. The power flow analysis identified branch (e.g., transmission line or transformer) loading and bus voltage violations under both normal and contingency (e.g., single line outage) operating conditions. The short circuit analysis determined the maximum three-phase symmetrical current at the nearby Sherman and Martin substations, and the PV analysis evaluated the impact of the Okeechobee plant on maximum power transfer capability across the Georgia/Florida interface. The stability analysis evaluated both first swing stability and system damping for a variety of system conditions and disturbances.

The analyses were designed to evaluate the impact of the Okeechobee plant by focusing on the relative performance of the system with the proposed plant in comparison to that of the existing (benchmark) system. The results are summarized below.

Power Flow Analysis

The power flow results, described in Section 4, show that a number of lines and transformers exceed their ratings for the 2003 summer benchmark system (without Okeechobee) under normal operating conditions (all lines in-service). Several pre-contingency voltage violations were also observed. Similarly, a number of branches exceed their ratings for the 2003 winter benchmark system under normal operating conditions, and several pre-contingency voltage violations were observed.

No pre-contingency adverse rating violations were observed with the Okeechobee plant in-service, for any of the studied dispatch scenarios. A few pre-contingency adverse voltage violations were observed with the Okeechobee plant in-service for several dispatch scenarios.

The post-contingency power flow analysis showed that a number of lines and transformers exceed their ratings for both the 2003 summer and 2003 winter



benchmark systems. Post-contingency voltage violations were also observed in both benchmark systems.

One 101% post-contingency adverse rating violation was observed in the FPC system for one contingency under one 2003 summer Okeechobee dispatch scenario. Several post-contingency adverse voltage violations were observed.

The post-contingency power flow analysis under 2003 winter conditions showed several adverse rating violations in the FPL system with magnitudes less than or equal to 108%. Several post-contingency adverse voltage violations were observed. All voltage violations, both pre-contingency and post-contingency, were relatively minor in magnitude and likely to be easily mitigated.

The apparent rating violations may be simulation artifacts and require further study. All voltage violations, both pre-contingency and post-contingency, were relatively minor in magnitude and likely to be easily mitigated.

Short-Circuit Analysis

The short circuit results show that the three-phase fault currents do not exceed 50kA at any of the 230kV or 500kV buses in the immediate vicinity of the Okeechobee plant.

PV Analysis

The PV analysis focused on the impact of an increase in power transfer from the SERC region on the Florida 500kV and 230kV bus voltages. The starting point for the benchmark PV analysis was the 2003 benchmark summer power flow. The increase in power flow across the Georgia/Florida interface was implemented by increasing the power generated at large generating plants outside Florida and decreasing the power generated at the Port Everglades and Lauderdale plants.

The Florida 500kV and 230kV bus voltages with all lines in-service were acceptable throughout the simulation, with or without the Okeechobee plant. For the contingency cases, a voltage collapse occurs at a Georgia/Florida interface flow of approximately 3650MW for the Turkey Pt. outage, and 3500MW for the St. Lucie outage – again, with or without the Okeechobee plant. This screening analysis indicates that the Okeechobee plant has negligible impact on the PV performance of the Georgia/Florida interface.

Stability Analysis

Under the 2003 summer and winter system conditions, the system response for all contingencies was first-swing stable with well-damped oscillations for the benchmark cases as well as for all Okeechobee dispatch scenarios. However, three Turkey Pt. units lost synchronism in response to contingency 10 (3-phase fault at Turkey Pt. 230kV bus, 5-cycle tripping of Turkey Pt. #3, 12-cycle backup tripping



of Turkey Pt.-Galloway 230kV line). These units lost synchronism for the benchmark cases as well as for all Okeechobee dispatch scenarios. Therefore, the addition of the Okeechobee plant has no significant impact on the performance of the Turkey Pt. units in response to this severe contingency.

Sensitivity Analysis

A sensitivity scenario was analyzed to evaluate the impact of the proposed Okeechobee plant in conjunction with the proposed New Smyrna Beach plant. Since the 2003 winter system loading is greater than the 2003 summer system loading, the sensitivity analysis focused on the winter system under the Northern FPL dispatch scenario.

One additional pre-contingency benchmark overload, related to the redispatch of the Sanford plant to accommodate New Smyrna Beach, was observed. No additional pre-contingency voltage violations were observed for this sensitivity scenario.

Two of the post-contingency overloads observed in the primary power flow analysis were also observed in this sensitivity analysis. There is, however, no significant difference in system performance with the Okeechobee plant alone or with both the Okeechobee and New Smyrna Beach plants. Several new post-contingency voltage violations were observed, but are likely to be easily mitigated.

The dynamic performance of the sensitivity scenario was first-swing stable with well-damped oscillations for all contingencies with and without the Okeechobee plant. Again, the Turkey Pt. units lost synchronism in response to contingency 10 under benchmark system conditions as well as all Okeechobee dispatch scenarios. Therefore, the addition of the Okeechobee plant has no significant impact on the performance of the Turkey Pt. units in response to this severe contingency.

Conclusion

The Okeechobee plant can be interconnected to the FPL system and deliver power to FPL or other utilities in peninsular Florida with no adverse impact on the transmission reliability of peninsular Florida.

Several minor adverse rating violations were noted which may be simulation artifacts and require further study. If necessary, equipment upgrades or other remedial measures can easily correct these deficiencies.



Appendix A
Transmission Line Rating Additions



Table A-1. Transmission Line Ratings Imported into FERC 715 Case from FPL Case, fpl_s02.raw

Bus #	Name	kV	Bus #	Name	kV	ID	Normal Rating	Emergency Rating
6	40TH ST	69.0	16	MIA BCH	69.0	99	114	114
16	MIA BCH	69.0	17	MIAMI	69.0	99	113	113
25	ARCH CK	138.0	776	CNTYLITP	138.0	99	241	241
32	CNTYLINE	138.0	71	MIA SH	138.0	99	308	308
35	CUTLER	138.0	38	DAVIS	138.0	99	178	178
35	CUTLER	138.0	785	DADELTP1	138.0	99	241	241
35	CUTLER	138.0	787	DADELTP2	138.0	99	241	241
36	DADE	138.0	41	FLAGAMI	138.0	99	241	241
36	DADE	138.0	50	GRATIGNY	138.0	99	270	270
36	DADE	138.0	69	MASTER	138.0	99	222	222
36	DADE	138.0	646	GLADETP1	138.0	99	215	215
36	DADE	138.0	887	FRON TP	138.0	99	117	117
38	DAVIS	138.0	40	FLA CITY	138.0	99	241	241
38	DAVIS	138.0	41	FLAGAMI	138.0	99	215	215
38	DAVIS	138.0	48	GOULDS	138.0	99	129	129
41	FLAGAMI	138.0	83	RIVERSDE	138.0	99	241	241
41	FLAGAMI	138.0	91	SO MIAMI	138.0	99	241	241
50	GRATIGNY	138.0	69	MASTER	138.0	99	241	241
50	GRATIGNY	138.0	152	LAUD PL	138.0	99	222	222
51	GREYNOLD	138.0	76	NORMANDY	138.0	99	196	196
51	GREYNOLD	138.0	152	LAUD PL	138.0	99	241	241
57	INDIAN C	138.0	65	LITTLE R	138.0	99	293	293
65	LITTLE R	138.0	73	MIAMI	138.0	99	222	222
65	LITTLE R	138.0	647	GLADETP2	138.0	99	196	196
72	MIA BCH	138.0	73	MIAMI	138.0	99	212	212
83	RIVERSDE	138.0	91	SO MIAMI	138.0	99	241	241
83	RIVERSDE	138.0	887	FRON TP	138.0	99	178	178
104	DADE	230.0	109	LEVEE	230.0	99	637	637
104	DADE	230.0	185	PT EVGLD	230.0	99	514	514
104	DADE	230.0	502	LAUDTAP2	230.0	99	514	514
105	DAVIS	230.0	109	LEVEE	230.0	99	514	514
106	FLAGAMI	230.0	109	LEVEE	230.0	99	637	637
106	FLAGAMI	230.0	112	MIA EAST	230.0	99	422	422
106	FLAGAMI	230.0	119	TURKEY P	230.0	99	526	526
106	FLAGAMI	230.0	501	LAUDTAP1	230.0	99	422	422
118	PENNSUCO	230.0	119	TURKEY P	230.0	99	514	514
118	PENNSUCO	230.0	175	ANDYTOWN	230.0	99	508	508
122	EMERSON	138.0	441	F PIERCE	138.0	99	241	241
123	EMERSON	230.0	464	MALABAR	230.0	99	370	370
126	HOLLYWTP	138.0	152	LAUD PL	138.0	99	222	222
126	HOLLYWTP	138.0	480	DUMFLDNG	138.0	99	178	178



Table A-1. Transmission Line Ratings Imported into FERC 715 Case from FPL Case, fpl_s02.raw (continued)

Bus #	Name	kV	Bus #	Name	kV	ID	Normal Rating	Emergency Rating
137	BROWARD	138.0	141	DEERFLD	138.0	99	241	241
137	BROWARD	138.0	148	HAWKINS	138.0	99	241	241
137	BROWARD	138.0	157	OAKLND P	138.0	98	241	241
137	BROWARD	138.0	157	OAKLND P	138.0	99	241	241
137	BROWARD	138.0	174	WESTNGHS	138.0	99	216	216
137	BROWARD	138.0	784	SISTR TP	138.0	99	241	241
146	SISTRUNK	138.0	157	OAKLND P	138.0	99	290	290
146	SISTRUNK	138.0	482	SOUTHSDE	138.0	99	308	308
146	SISTRUNK	138.0	524	NEWLAUD	138.0	99	241	241
148	HAWKINS	138.0	524	NEWLAUD	138.0	99	258	258
150	HOLLYWOD	138.0	524	NEWLAUD	138.0	99	215	215
150	HOLLYWOD	138.0	888	PORT TAP	138.0	99	215	215
152	LAUD PL	138.0	778	BEVERTP2	138.0	99	308	308
152	LAUD PL	138.0	779	MASTERTP	138.0	99	308	308
174	WESTNGHS	138.0	249	RANCH	138.0	99	241	241
175	ANDYTOWN	230.0	181	LAUD PL	230.0	98	514	514
175	ANDYTOWN	230.0	181	LAUD PL	230.0	99	514	514
175	ANDYTOWN	230.0	501	LAUDTAP1	230.0	99	637	637
175	ANDYTOWN	230.0	665	CONSRVTN	230.0	97	514	514
175	ANDYTOWN	230.0	665	CONSRVTN	230.0	98	514	514
175	ANDYTOWN	230.0	665	CONSRVTN	230.0	99	514	514
176	BROWARD	230.0	268	RANCH	230.0	99	514	514
176	BROWARD	230.0	273	YAMATO	230.0	99	514	514
176	BROWARD	230.0	535	CORBETT	230.0	99	514	514
176	BROWARD	230.0	665	CONSRVTN	230.0	98	514	514
176	BROWARD	230.0	665	CONSRVTN	230.0	99	514	514
181	LAUD PL	230.0	258	CEDAR	230.0	99	514	514
201	BL GLADE	69.0	210	PAHOKEE	69.0	99	121	121
205	MARTIN	69.0	277	BRYANT	69.0	99	89	89
208	OKECHOBE	69.0	213	SHERMAN	69.0	99	108	108
218	BEE LINE	138.0	245	PLUMOSUS	138.0	99	215	215
223	CEDAR	138.0	249	RANCH	138.0	99	241	241
223	CEDAR	138.0	257	YAMATO	138.0	99	241	241
232	HOBE	138.0	245	PLUMOSUS	138.0	98	222	222
232	HOBE	138.0	245	PLUMOSUS	138.0	99	222	222
232	HOBE	138.0	247	PT SEWEL	138.0	99	222	222
249	RANCH	138.0	250	RIVIERA	138.0	98	308	308
249	RANCH	138.0	250	RIVIERA	138.0	99	308	308
249	RANCH	138.0	253	W PM BCH	138.0	99	308	308
249	RANCH	138.0	547	OSCEOLA	138.0	99	178	178
250	RIVIERA	138.0	253	W PM BCH	138.0	99	221	221
250	RIVIERA	138.0	539	OAKES	138.0	99	221	221
257	YAMATO	138.0	990	DEERFDTP	138.0	99	241	241



Table A-1. Transmission Line Ratings Imported into FERC 715 Case from FPL Case, fpl_s02.raw (continued)

Bus #	Name	kV	Bus #	Name	kV	ID	Normal Rating	Emergency Rating
258	CEDAR	230.0	273	YAMATO	230.0	99	637	637
258	CEDAR	230.0	535	CORBETT	230.0	99	514	514
263	INDN TWN	230.0	265	MARTIN	230.0	99	912	912
263	INDN TWN	230.0	268	RANCH	230.0	99	637	637
266	MIDWAY	230.0	268	RANCH	230.0	99	741	741
266	MIDWAY	230.0	464	MALABAR	230.0	99	370	370
268	RANCH	230.0	535	CORBETT	230.0	99	627	627
288	ALICO	138.0	333	SOLANA	138.0	99	179	179
288	ALICO	138.0	595	FTMYERTP	138.0	99	222	222
288	ALICO	138.0	649	BUCK-FPL	138.0	99	241	241
294	CAPRI	138.0	299	COLLIER	138.0	99	222	222
295	CHARLOTE	138.0	330	RINGLING	138.0	99	178	178
298	COCOPLUM	138.0	311	HARBOR	138.0	99	222	222
299	COLLIER	138.0	305	ESTERO	138.0	99	158	158
299	COLLIER	138.0	333	SOLANA	138.0	99	222	222
301	CORTEZ	138.0	307	FRT INDS	138.0	99	315	315
301	CORTEZ	138.0	597	PAYNETAP	138.0	99	222	222
303	EDISON	138.0	309	FT MYERS	138.0	99	222	222
306	F MY SUB	138.0	309	FT MYERS	138.0	99	287	287
309	FT MYERS	138.0	864	MONT-FPL	138.0	99	178	178
317	LAURELWD	138.0	319	MYAKKA	138.0	99	222	222
317	LAURELWD	138.0	755	HOWARD	138.0	99	222	222
330	RINGLING	138.0	755	HOWARD	138.0	99	178	178
342	CHARLOTE	230.0	348	LAURELWD	230.0	99	514	514
342	CHARLOTE	230.0	353	WHIDDEN	230.0	99	370	370
343	COLLIER	230.0	351	ORANGE R	230.0	99	514	514
343	COLLIER	230.0	750	ALICO	230.0	99	637	637
348	LAURELWD	230.0	350	MYAKKA	230.0	99	637	637
351	ORANGE R	230.0	535	CORBETT	230.0	99	402	402
351	ORANGE R	230.0	750	ALICO	230.0	99	514	514
352	RINGLING	230.0	751	HOWARD	230.0	99	627	627
355	NRIVGOAB	115.0	384	COLUMBIA	115.0	99	148	148
367	BUNNELL	230.0	474	VOLUSIA	230.0	99	502	502
375	BALDWIN	115.0	769	MACDONTTP	115.0	99	148	148
377	BULOW	115.0	378	BUNNELL	115.0	99	73	73
378	BUNNELL	115.0	408	MATANZAS	115.0	99	222	222
378	BUNNELL	115.0	419	PUTNAM	115.0	99	108	108
382	CAPE K	115.0	423	SO CAPE	115.0	99	143	143
382	CAPE K	115.0	694	BARNA	115.0	98	145	145
382	CAPE K	115.0	694	BARNA	115.0	99	145	145
383	CELERY	115.0	414	NORRIS	115.0	99	163	163
383	CELERY	115.0	422	SN PLANT	115.0	99	163	163
386	CRES CTY	115.0	653	POMONATP	115.0	99	73	73

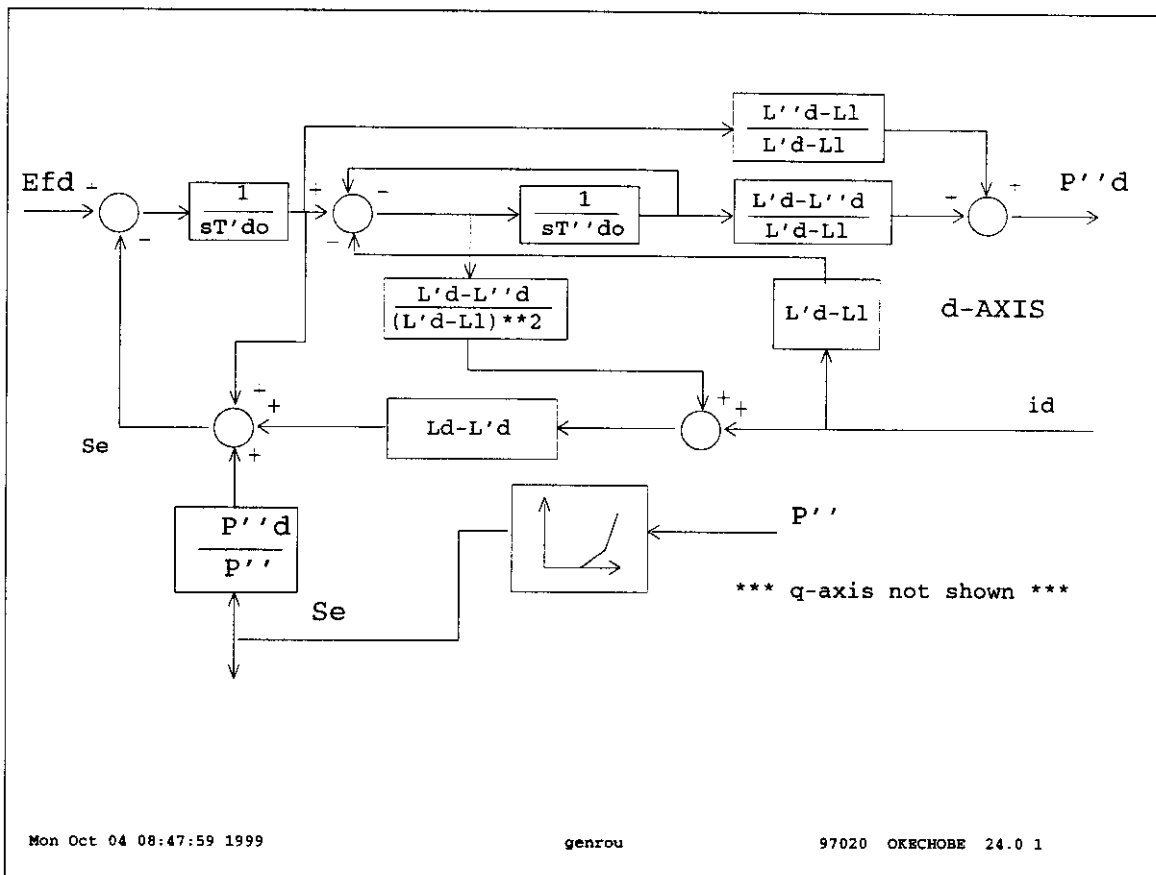

Table A-1. Transmission Line Ratings Imported into FERC 715 Case from FPL Case, fpl_s02.raw (continued)

Bus #	Name	kV	Bus #	Name	kV	ID	Normal Rating	Emergency Rating
397	HOLLY HL	115.0	415	ORMOND	115.0	99	148	148
408	MATANZAS	115.0	425	ST JOHNS	115.0	99	222	222
411	N RIV TP	115.0	504	MAXVILTP	115.0	99	108	108
414	NORRIS	115.0	694	BARNA	115.0	99	185	185
419	PUTNAM	115.0	425	ST JOHNS	115.0	99	73	73
419	PUTNAM	115.0	861	CRILL SW	115.0	99	148	148
423	SO CAPE	115.0	694	BARNA	115.0	99	160	160
430	VOLUSIA	115.0	713	REED	115.0	99	201	201
434	BREVARD	138.0	436	CLEAR LK	138.0	98	241	241
434	BREVARD	138.0	436	CLEAR LK	138.0	99	241	241
434	BREVARD	138.0	437	COCO BCH	138.0	99	301	301
434	BREVARD	138.0	440	EAU GALL	138.0	99	241	241
437	COCO BCH	138.0	444	IND HRBR	138.0	99	178	178
437	COCO BCH	138.0	454	SO CAPE	138.0	99	221	221
440	EAU GALL	138.0	446	MALABAR	138.0	99	222	222
440	EAU GALL	138.0	488	PALMBYTP	138.0	99	196	196
445	INDIALAN	138.0	446	MALABAR	138.0	99	221	221
458	BALDWIN	230.0	463	DUVAL	230.0	99	402	402
460	BREVARD	230.0	461	CAPE K	230.0	99	514	514
460	BREVARD	230.0	464	MALABAR	230.0	98	450	450
460	BREVARD	230.0	464	MALABAR	230.0	99	450	450
461	CAPE K	230.0	693	BARNA	230.0	99	402	402
467	POINSETT	230.0	469	SN PLANT	230.0	99	370	370
468	PUTNAM	230.0	474	VOLUSIA	230.0	99	502	502
469	SN PLANT	230.0	474	VOLUSIA	230.0	99	370	370
484	LEWISTAP	115.0	840	MILLCREK	115.0	99	201	201
524	NEWLAUD	138.0	784	SISTR TP	138.0	99	241	241
525	NEWLAUD	230.0	665	CONSRVTN	230.0	99	514	514
530	SANPIPER	138.0	685	MONTEREY	138.0	99	178	178
530	SANPIPER	138.0	796	WH CTYTP	138.0	99	178	178
532	TURNPIKE	230.0	582	BRIDGE	230.0	99	647	647
582	BRIDGE	230.0	601	PLUMOSUS	230.0	99	647	647



Appendix B
Okeechobee Plant Dynamic Models



ld	1.8800	s12	0.5700
lpd	0.2900	h	2.5200
lppd	0.2000	d	0.0000
lq	1.8100	rcomp	0.0000
lpq	0.4900	xcomp	0.0000
lppq	0.2000	accel	0.0000
ll	0.1650		
ra	0.0000		
tpdo	4.0000		
tppdo	0.0400		
tpqo	0.5300		
tppqo	0.0550		
s1	0.1600		

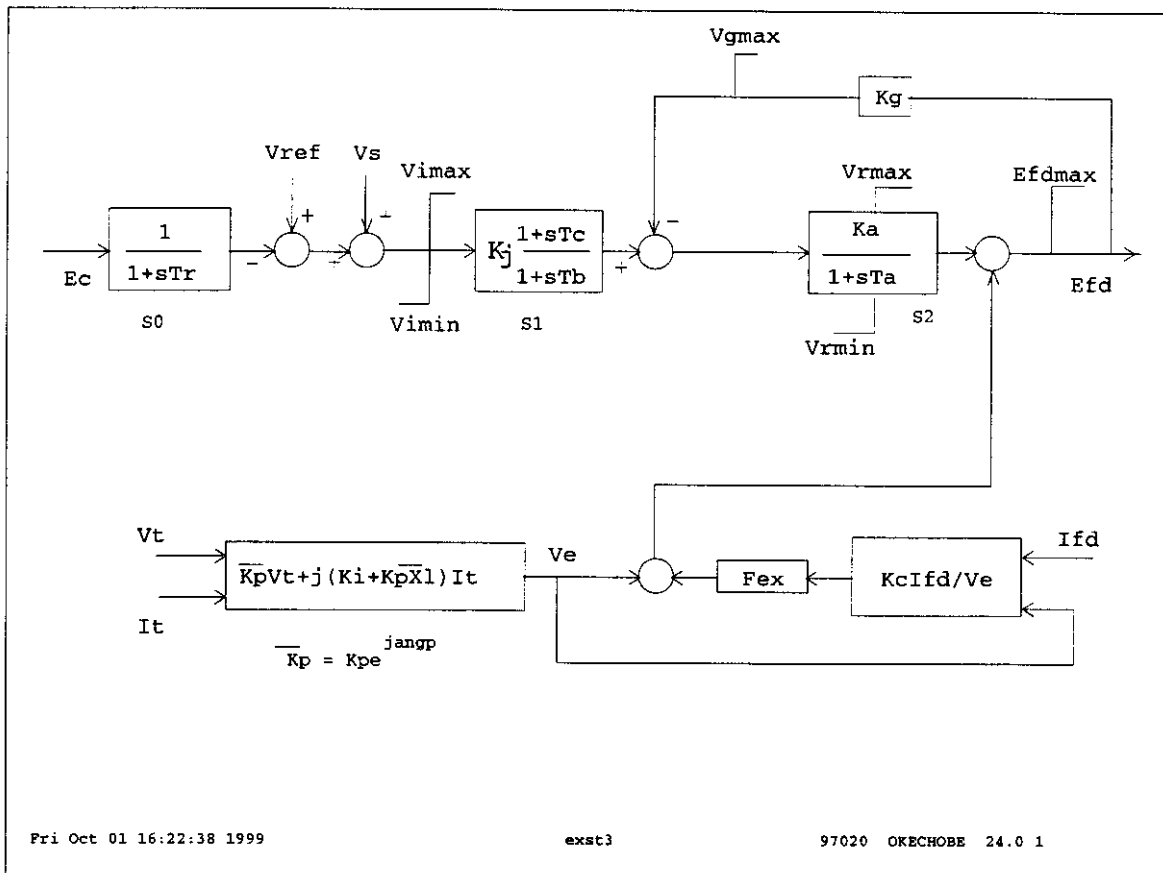

tr	0.0167	efdmax	7.0100
vimax	0.2000	kc	0.2330
vimin	-0.2000	x1	0.1000
kj	200.0000	vgmax	6.1000
tc	1.0000	angp	0.0000
tb	10.0000		
ka	7.6000		
ta	0.5000		
vrmax	1.0000		
vrmin	0.0000		
kg	1.0000		
kp	6.3300		
ki	0.0000		

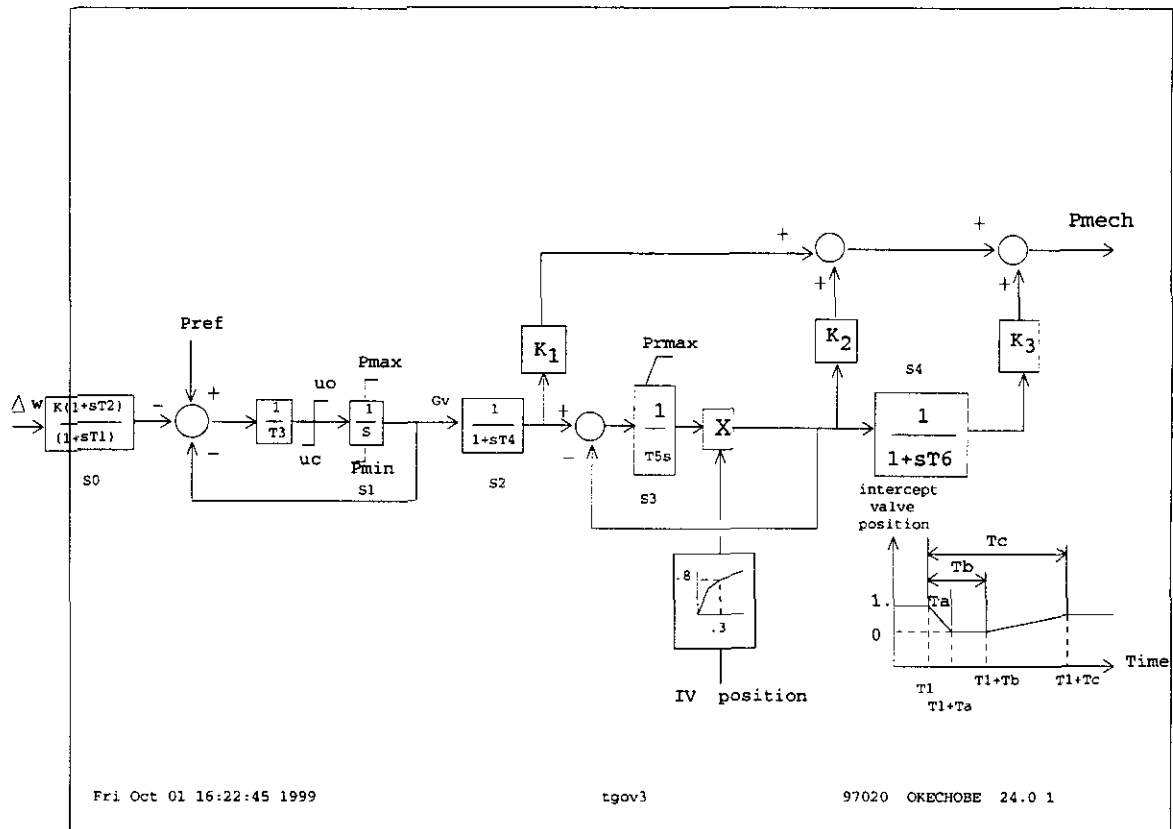

k	20.0000	k3	0.3910	gv5	0.5000
t1	0.0000	ta	0.1800	pgv5	0.9100
t2	0.0000	tb	1.2300	gv6	1.0000
t3	0.1000	tc	11.3300	pgv6	1.0000
uo	0.2000	prmax	0.9500		
uc	-0.2000	gv1	0.0000		
pmax	0.9500	pgv1	0.0000		
pmin	0.0000	gv2	0.1000		
t4	0.5200	pgv2	0.4500		
k1	0.3330	gv3	0.2000		
t5	6.0000	pgv3	0.6700		
k2	0.2760	gv4	0.3000		
t6	0.3800	pgv4	0.8000		



Appendix C

Power Flow Analysis Contingency List

Table C-1. Generator Outages

#	Name	kV	ID	Description
1	TP.3	22	1	Loss of Turkey Pt. #3
2	LAUD.4CT	18	1	Loss of Lauderdale CT #4
3	MARTIN 2	22	1	Loss of Martin #2
4	STLUCIE2	22	1	Loss of St. Lucie #2
5	FT.MYER2	22	1	Loss of Ft. Myers #2
6	MANATEE2	22	1	Loss of Manatee #2
7	PUTN.ICT	13.8	1	Loss of Putnam CT #1
8	CAPECAN1	22	1	Loss of Cape Canaveral #1
9	SANFORD5	24	1	Loss of Sanford #5
10	INDTN.CG	24	1	Loss of Indiantown
11	MR3.CT	20	1	Loss of Martin CT #3
12	CR RV G3	22	1	Loss of Crystal River#3
13	ST JNS 1	24	1	Loss of St. Johns River #1
14	IRP #3	22	1	Loss of Indian River #3
15	STN #2	24	1	Loss of Stanton #2
16	SEM. 1	23	1	Loss of Seminole #1
17	OKECHOBE	24	1	Loss of Okeechobee



Figure C-2. 500kV Transmission Line Outages

#	Bus Name	kV	Bus Name	kV	ID	Description
18	LEVEE	500	ANDYTOWN	500	1	Loss of Levee-Andytown 500kV Line
19	ANDYTOWN	500	CORBETT	500	1	Loss of Andytown-Corbett 500kV Line
20	ANDYTOWN	500	MARTIN	500	1	Loss of Andytown-Martin 500kV Line
21	ANDYTOWN	500	ORANGE R	500	1	Loss of Andytown-Orange River 500kV Line
22	CORBETT	500	MARTIN	500	1	Loss of Corbett-Martin 500kV Line
23	CORBETT	500	MIDWAY	500	1	Loss of Corbett-Midway 500kV Line
24	CORBETT	500	CONSRVTN	500	1	Loss of Corbett-Conservation 500kV Line
25	MARTIN	500	MIDWAY	500	1	Loss of Martin-Midway 500kV Line
26	MARTIN	500	POINSETT	500	1	Loss of Martin-Poinsett 500kV Line
27	MIDWAY	500	POINSETT	500	1	Loss of Midway-Poinsett 500kV Line
28	DUVAL	500	POINSETT	500	1	Loss of Duval-Poinsett 500kV Line
29	DUVAL	500	RICE	500	1	Loss of Duval-Rice 500kV Line
30	DUVAL	500	HATCH	500	1	Loss of Duval-Hatch 500kV Line
31	DUVAL	500	THALMANN	500	1	Loss of Duval-Thalmann 500kV Line
32	POINSETT	500	RICE	500	1	Loss of Poinsett-Rice 500kV Line
33	LK TARPEN	500	LKT-DUM1	500	1	Loss of Lake Tarpon-Dummy 1 500kV Line
34	LK TARPEN	500	LKT-DUM2	500	1	Loss of Lake Tarpon-Dummy 2 500kV Line
35	LK TARPEN	500	BRKRIDGE	500	1	Loss of Lake Tarpon-Brookridge 500kV Line
36	KATH-DUM	500	KATHLEEN	500	1	Loss of Dummy-Kathleen 500kV Line
37	KATHLEEN	500	CENT FLA	500	1	Loss of Kathleen-Central Florida 500kV Line
38	BRDG-DUM	500	BRKRIDGE	500	1	Loss of Dummy-Brookridge 500kV Line
39	BRKRIDGE	500	CRYST RV	500	1	Loss of Brookridge-Crystal River 500kV Line
40	CENT FLA	500	CENT-DM2	500	1	Loss of Central Florida-Dummy 2 500kV Line
41	CENT FLA	500	CENT-DUM	500	1	Loss of Central Florida-Dummy 500kV Line
42	CENT FLA	500	CRYST RV	500	1	Loss of Central Florida-Crystal River 500kV Line
43	CRYST RV	500	CRYST R5	500	1	Loss of Crystal River-Crystal River 5 500kV Line
44	HATCH	500	BONAIRE	500	1	Loss of Hatch-Bonaire 500kV Line
45	HATCH	500	THALMANN	500	1	Loss of Hatch-Thalmann 500kV Line
46	HATCH	500	N TIFTON	500	1	Loss of Hatch-N. Tifton 500kV Line
47	THALMANN	500	WMCINTSH	500	1	Loss of Thalmann-McIntosh 500kV Line



Figure C-3. 230kV Transmission Line Outages

#	Bus Name	kV	Bus Name	kV	ID	Description
48	EMERSON	230	MIDWAY	230	1	Loss of Emerson-Midway 230kV Line
49	EMERSON	230	MALABAR	230	99	Loss of Emerson-Malabar 230kV Line
50	BROWARD	230	RANCH	230	99	Loss of Broward-Ranch 230kV Line
51	BROWARD	230	YAMATO	230	99	Loss of Broward-Yamato 230kV Line
52	BROWARD	230	CORBETT	230	99	Loss of Broward-Corbett 230kV Line
53	BROWARD	230	CONSRVTN	230	99	Loss of Broward-Conservation 230kV Line
54	WARFIELD	230	INDN TWN	230	1	Loss of Warfield-Indiantown 230kV Line
55	WARFIELD	230	MARTIN	230	1	Loss of Warfield-Martin 230kV Line
56	CEDAR	230	LAUD PL	230	99	Loss of Cedar-Lauderdale 230kV Line
57	CEDAR	230	RANCH	230	1	Loss of Cedar-Ranch 230kV Line
58	CEDAR	230	YAMATO	230	99	Loss of Cedar-Yamato 230kV Line
59	CEDAR	230	CORBETT	230	99	Loss of Cedar-Corbett 230kV Line
60	SANPIPER	230	TURNPIKE	230	1	Loss of Sandpiper-Turnpike 230kV Line
61	HOBE	230	BRIDGE	230	1	Loss of Hobe-Bridge 230kV Line
62	INDN TWN	230	MARTIN	230	99	Loss of Indiantown-Martin 230kV Line
63	INDN TWN	230	MIDWAY	230	1	Loss of Indiantown-Midway 230kV Line
64	INDN TWN	230	RANCH	230	99	Loss of Indiantown-Ranch 230kV Line
65	INDN TWN	230	BRIDGE	230	1	Loss of Indiantown-Bridge 230kV Line
66	MARTIN	230	OKECHOBE	230	1	Loss of Martin-Okeechobee 230kV Line
67	OKECHOBE	230	SHERMAN	230	1	Loss of Okeechobee-Sherman 230kV Line
68	MIDWAY	230	RANCH	230	99	Loss of Midway-Ranch 230kV Line
69	MIDWAY	230	SHERMAN	230	1	Loss of Midway-Sherman 230kV Line
70	MIDWAY	230	ST LUCIE	230	1	Loss of Midway-St. Lucie 230kV Line
71	MIDWAY	230	MALABAR	230	99	Loss of Midway-Malabar 230kV Line
72	MIDWAY	230	TURNPIKE	230	1	Loss of Midway-Turnpike 230kV Line
73	RANCH	230	CORBETT	230	1	Loss of Ranch-Corbett 230kV Line
74	COLLIER	230	ORANGE R	230	99	Loss of Collier-Orange River 230kV Line
75	COLLIER	230	ALICO	230	99	Loss of Collier-Alico 230kV Line
76	FT MYERS	230	CHARLOTE	230	2	Loss of Ft. Myers-Charlotte 230kV Line
77	FT MYERS	230	ORANGE R	230	1	Loss of Ft. Myers-Orange River 230kV Line
78	FT MYERS	230	CALUSA	230	1	Loss of Ft. Myers-Calusa 230kV Line
79	ORANGE R	230	CORBETT	230	99	Loss of Orange River-Corbett 230kV Line
80	ORANGE R	230	ALICO	230	99	Loss of Orange River-Alico 230kV Line
81	BUNNELL	230	PUTNAM	230	1	Loss of Bunnell-Putnam 230kV Line
82	BUNNELL	230	VOLUSIA	230	99	Loss of Bunnell-Volusia 230kV Line
83	BREVARD	230	CAPE K	230	99	Loss of Brevard-Cape Canaveral 230kV Line
84	BREVARD	230	MALABAR	230	98	Loss of Brevard-Malabar 230kV Line



Figure C-3. 230kV Transmission Line Outages (continued)

#	Bus Name	kV	Bus Name	kV	ID	Description
85	BREVARD	230	POINSETT	230	2	Loss of Brevard-Poinsett 230kV Line
86	CAPE K	230	BARNA	230	99	Loss of Cape Canaveral-Barna 230kV Line
87	CAPE K	230	IND RIV	230	1	Loss of Cape Canaveral-Indian River 230kV Line
88	NORRIS	230	VOLUSIA	230	1	Loss of Norris-Volusia 230kV Line
89	NORRIS	230	BARNA	230	1	Loss of Norris-Barna 230kV Line
90	POINSETT	230	SN PLANT	230	99	Loss of Poinsett-Sanford 230kV Line
91	POINSETT	230	TAYLR CK	230	1	Loss of Poinsett-Taylor Creek 230kV Line
92	PUTNAM	230	HUDSON	230	1	Loss of Putnam-Hudson 230kV Line
93	PUTNAM	230	BRADFORD	230	1	Loss of Putnam-Bradford 230kV Line
94	PUTNAM	230	TOCOI	230	1	Loss of Putnam-Tocoi 230kV Line
95	PUTNAM	230	VOLUSIA	230	99	Loss of Putnam-Volusia 230kV Line
96	SN PLANT	230	SYLVAN	230	1	Loss of Sanford-Sylvan 230kV Line
97	SN PLANT	230	DEBARY	230	1	Loss of Sanford-Debary 230kV Line
98	SN PLANT	230	ALTAMONT	230	1	Loss of Sanford-Altamont 230kV Line
99	TURNPIKE	230	BRIDGE	230	99	Loss of Turnpike-Bridge 230kV Line
100	BRIDGE	230	PLUMOSUS	230	99	Loss of Bridge-Plumosus 230kV Line
101	CONSRVTN	230	ANDYTOWN	230	97	Loss of Conservation-Andytown 230kV Line
102	CONSRVTN	230	NEWLAUD	230	99	Loss of Conservation-New Lauderdale 230kV Line

Figure C-4. 69kV Transmission Line Outages

#	Bus Name	kV	Bus Name	kV	ID	Description
103	MARTIN	69	BRYANT	69	99	Loss of Martin-Bryant 69kV Line
104	OKECHOBE	69	SHERMAN	69	2	Loss of Okeechobee-Sherman 69kV Line
105	OKECHOBE	69	MORRIS	69	1	Loss of Okeechobee-Morris 69kV Line
106	BRITGOAB	69	MORRIS	69	1	Loss of Brighton-Morris 69kV Line
107	BASINGR	69	MORRIS	69	1	Loss of Bassinger-Morris 69kV Line



Figure C-5. Transformer Outages

#	Bus Name	kV	Bus Name	kV	ID	Description
108	LEVEE	500	LEVEE	230	1	Loss of Levee 500/230kV Transformer
109	ANDYTOWN	500	ANDYTOWN	230	1	Loss of Andytown 500/230kV Transformer
110	CORBETT	500	CORBETT	230	1	Loss of Corbett 500/230kV Transformer
111	MARTIN	500	MARTIN	230	1	Loss of Martin 500/230kV Transformer
112	MIDWAY	500	MIDWAY	230	1	Loss of Midway 500/230kV Transformer
113	ORANGE R	500	ORANGE R	230	1	Loss of Orange River 500/230kV Transformer
114	DUVAL	500	DUVAL	230	1	Loss of Duval 500/230kV Transformer
115	POINSETT	500	POINSETT	230	1	Loss of Poinsett 500/230kV Transformer
116	RICE	500	RICE	230	1	Loss of Rice 500/230kV Transformer
117	CONSRVTN	500	CONSRVTN	230	1	Loss of Conservation 500/230kV Transformer
118	HATCH	500	HATCH 2	24	1	Loss of Hatch 500/24kV Transformer
119	EMERSON	230	EMERSON	138	1	Loss of Emerson 230/138kV Transformer
120	BROWARD	230	BROWARD	138	1	Loss of Broward 230/138kV Transformer
121	CEDAR	230	CEDAR	138	1	Loss of Cedar 230/138kV Transformer
122	SANPIPER	230	SANPIPER	138	1	Loss of Sandpiper 230/138kV Transformer
123	HOBE	230	HOBE	138	1	Loss of Hobe 230/138kV Transformer
124	MARTIN	230	MARTIN	69	1	Loss of Martin 230/69kV Transformer
125	MIDWAY	230	MIDWAY	138	2	Loss of Midway 230/138kV Transformer
126	RANCH	230	RANCH	138	1	Loss of Ranch 230/138kV Transformer
127	SHERMAN	230	SHERMAN	69	2	Loss of Sherman 230/69kV Transformer
128	YAMATO	230	YAMATO	138	2	Loss of Yamato 230/138kV Transformer
129	COLLIER	230	COLLIER	138	1	Loss of Collier 230/138kV Transformer
130	BUNNELL	230	BUNNELL	115	1	Loss of Bunnell 230/115kV Transformer
131	BREVARD	230	BREVARD	138	2	Loss of Brevard 230/138kV Transformer
132	CAPE K	230	CAPE K	115	2	Loss of Cape Canaveral 230/115kV Transformer
133	MALABAR	230	MALABAR	138	3	Loss of Malabar 230/138kV Transformer
134	NORRIS	230	NORRIS	115	1	Loss of Norris 230/115kV Transformer
135	PUTNAM	230	PUTNAM	115	2	Loss of Putnam 230/115kV Transformer
136	SN PLANT	230	SN PLANT	115	1	Loss of Sanford 230/115kV Transformer
137	VOLUSIA	230	VOLUSIA	115	1	Loss of Volusia 230/115kV Transformer #1
138	VOLUSIA	230	VOLUSIA	115	3	Loss of Volusia 230/115kV Transformer #3
139	PLUMOSUS	230	PLUMOSUS	138	1	Loss of Plumosus 230/138kV Transformer
140	BARNA	230	BARNA	115	1	Loss of Barna 230/115kV Transformer
141	ALICO	230	ALICO	138	1	Loss of Alico 230/138kV Transformer



Appendix D
Power Flow Analysis Results



Figure D-1. Pre-Contingency Branch Loading for 2003 Summer System (% of Rate 1).

Bus 1	kV	Bus 2	kV	ID	Area	Benchmark	TEC Dispatch	JEA Dispatch	So. FPL Dispatch	No. FPL Dispatch	FPC Dispatch
BELVEW	69	DLARPTTP	69	1	2	136	136	136	136	136	136
BRT ST T	138	LEE	138	1	1	132	132	132	132	132	132
CORBETT	138	LEE	138	1	1	103	102	103	103	103	102
DALASMET	69	DALLAS	69	1	2	125	127	123	126	124	127
DH2	22	DEERHVN	138	1	4	102	102	102	102	102	102
DLARPTTP	69	DALASMET	69	1	2	125	127	123	126	124	127
FRON TP	138	DADE	138	99	1	133	134	133	135	133	133
HARDE 3	13.8	CC PLANT	230	1	12	108	108	108	108	108	108
HRDECT12	13.2	CC PLANT	230	1	12	113	113	113	113	113	113
HRDECT34	13.2	CC PLANT	230	1	12	117	115	116	120	116	115
LAUD PL	230	LGT13-16	13.8	1	1	102	102	102	102	102	102
LAUD PL	230	LGT17-20	13.8	2	1	102	102	102	102	102	102
LAUD PL	230	LGT21-24	13.8	3	1	102	102	102	102	102	102
MARATHON	138	MARATHON	25	1	1	106	106	106	106	106	106
MARATHON	138	MARATHON	25	2	1	106	106	106	106	106	106
MICCOSK	115	MICCOSK	69	1	2	134	134	134	134	134	134
NEWLAUD	138	LGT 1-2	13.8	1	1	101	101	101	102	101	101
NEWLAUD	138	LGT 3-4	13.8	2	1	101	101	101	102	101	101
NEWLAUD	138	LGT 5-6	13.8	3	1	101	101	101	102	101	101
PASADENA	230	PASADENA	115	1	2	104	104	104	104	104	104
PUTNAM	230	PUTN.1ST	13.8	1	1	103	103	101	103	<100	103
PUTNAM	230	PUTN.2ST	13.8	1	1	103	103	101	103	<100	103
REDDICK	69	MARTIN W	69	1	2	103	102	108	102	106	102
RIVIERA	138	RIVIERA4	20	1	1	110	111	110	111	110	110
SEA P TP	115	HUDSON	115	1	2	115	115	115	115	115	115



Figure D-1. Pre-Contingency Branch Loading for 2003 Summer System (% of Rate 1) continued.

Bus 1	kV	Bus 2	kV	ID	Area	Benchmark	TEC Dispatch	JEA Dispatch	So. FPL Dispatch	No. FPL Dispatch	FPC Dispatch
SECICT56	13.2	SEMINOLE	230	1	12	121	120	117	121	121	122
SO GIB	230	B BEND	230	1	16	102	<100	105	<100	105	107
TURNER	115	SN PLANT	115	1	1	105	106	108	105	109	112



Figure D-2. Pre-Contingency Branch Loading for 2003 Winter System (% of Rate 1).

Bus 1	kV	Bus 2	kV	ID	Area	Benchmark	TEC Dispatch	JEA Dispatch	So. FPL Dispatch	No. FPL Dispatch	FPC Dispatch
ARCADIA	69	CHARLOTE	69	1	1	108	107	107	108	107	107
BELVEW	69	DLARPTTP	69	1	2	208	208	208	208	208	208
BIGB GT3	13.2	BIGBGT-T	230	1	16	112	112	112	112	112	112
BIGBGT2	13.2	BIGBGT-T	230	1	16	112	112	112	112	112	112
BRNT STR	138	BRT ST T	138	1	1	106	106	106	106	106	106
BUCK-FPL	138	BUCKHAM	138	1	1	122	122	122	122	122	122
BUCK-FPL	138	FT MYERS	138	1	1	101	101	101	101	101	101
CHARLOTE	69	CHARLOTE	138	1	1	119	119	119	119	119	119
CORBETT	138	LEE	138	1	1	123	122	122	123	122	122
DALASMET	69	DALLAS	69	1	2	165	168	163	165	165	168
DISSTON	115	NEAST B	115	1	2	108	108	108	108	108	108
DLARPTTP	69	DALASMET	69	1	2	165	168	163	165	165	168
ESTERO	138	ALICO	138	1	1	106	106	106	106	106	106
GANNON	230	GANNON 5	20	1	16	102	102	102	102	102	102
GANNON	230	GANNON 6	22	1	16	106	106	106	106	106	106
HARDE 3	13.8	CC PLANT	230	1	12	124	124	124	124	124	124
HRDECT12	13.2	CC PLANT	230	1	12	127	127	127	127	127	127
HRDECT34	13.2	CC PLANT	230	1	12	127	127	127	127	127	127
HUDSONTP	115	HUDSON	115	1	2	102	104	101	102	102	<100
IC P3&4	13.8	INTERCSN	69	1	2	113	113	113	113	114	109
IC P5&6	13.8	INTERCSN	69	1	2	113	113	113	113	114	110
JUNEAU-E	138	JUNEAU-E	69	1	16	103	<100	104	103	104	105
LAUD PL	230	LGT13-16	13.8	1	1	117	117	117	117	117	117
MARATHON	138	MARATHON	25	1	1	103	103	103	103	103	103
MARATHON	138	MARATHON	25	2	1	103	103	103	103	103	103



Figure D-2. Pre-Contingency Branch Loading for 2003 Winter System (% of Rate 1) continued.

Bus 1	kV	Bus 2	kV	ID	Area	Benchmark	TEC Dispatch	JEA Dispatch	So. FPL Dispatch	No. FPL Dispatch	FPC Dispatch
MARION O	69	BELVEU	69	1	2	102	102	102	102	102	102
MICCOSK	115	MICCOSK	69	1	2	158	158	158	158	158	158
OCALA 1	230	OCALA 1	230	1	2	141	140	143	141	141	140
PT EVGLD	230	PEGT1-4	13.8	1	1	108	108	108	108	108	108
PT EVGLD	230	PEGT5-8	13.8	2	1	108	108	108	108	108	108
PT EVGLD	230	PEGT9-12	13.8	3	1	108	108	108	108	108	108
PUTNAM	230	PUTN.1CT	13.8	1	1	110	110	107	110	110	110
PUTNAM	230	PUTN.1ST	13.8	1	1	120	120	117	120	120	120
PUTNAM	230	PUTN.2CT	13.8	1	1	110	110	107	110	110	110
PUTNAM	230	PUTN.2ST	13.8	1	1	120	120	117	120	120	120
RIVIERA	138	RIVIERA4	20	1	1	111	111	111	111	111	111
SEA P TP	115	HUDSON	115	1	2	162	162	162	162	162	162
SEA PNS	115	SEA P TP	115	1	2	121	121	121	121	121	121
SECICT56	13.2	SEMINOLE	230	1	12	127	127	127	127	127	127
SO GIB	230	B BEND	230	1	16	100	<100	104	<100	103	106
TGRBAY 1	18	TIGER PL	230	1	2	101	<100	101	101	102	101
TGRBAY 2	13.8	TIGER PL	230	1	2	105	105	105	105	105	105
TUR P3&4	13.2	TURNER	115	1	2	108	108	108	108	108	108
VB SUB1	69	VB SUB1	69	1	17	104	104	104	104	104	104



Figure D-3. Pre-Contingency Voltage Violations for 2003 Summer System.

Bus	kV	Area	Benchmark	TEC Dispatch	JEA Dispatch	So. FPL Dispatch	No. FPL Dispatch	FPC Dispatch
ALICO	230.0	1	1.052	1.051	1.052	1.052	1.052	1.052
B BEND	230.0	16	1.055	1.055	1.055	1.055	1.055	1.055
BIGBGT-T	230.0	16	1.055	1.055	1.055	1.055	1.055	1.055
CRYST R5	500.0	2	1.051	1.051	1.051	1.051	1.051	1.051
DUMMY 1	230.0	2	1.052	1.052	1.052	1.052	1.052	<1.050
POINSETT	500.0	1	1.052	1.055	1.059	1.053	1.055	1.056
RUSKIN T	230.0	16	1.050	1.050	<1.050	<1.050	1.050	1.050
RICE	500.0	1	<1.050	1.051	1.053	<1.050	1.051	1.052
SANIBEL	138.0	1	>0.950	>0.950	>0.950	0.949	>0.950	>0.950
TIMB PN	115.0	2	0.946	0.943	0.946	0.945	0.946	0.948

Figure D-4. Pre-Contingency Voltage Violations for 2003 Winter System.

Bus	kV	Area	Benchmark	TEC Dispatch	JEA Dispatch	So. FPL Dispatch	No. FPL Dispatch	FPC Dispatch
B BEND	230.0	16	1.055	1.055	1.055	1.055	1.055	1.055
BIGBGT-T	230.0	16	1.055	1.055	1.055	1.055	1.055	1.055
CRYST R5	500.0	2	1.051	1.052	1.051	1.051	1.051	1.051
DUMMY 1	230.0	2	1.050	1.051	1.050	1.050	1.051	<1.050
DUVAL	500.0	1	<1.050	<1.050	1.051	<1.050	<1.050	<1.050
POINSETT	500.0	1	1.051	1.054	1.059	1.051	1.054	1.055
RICE	500.0	1	<1.050	1.050	1.053	<1.050	<1.050	1.051
TIMB PN	115.0	2	0.941	0.941	0.942	0.941	0.942	0.942



Figure D-5. Post-Contingency Branch Loading for 2003 Summer TEC Dispatch.

From Bus		To Bus		FPC Dispatch				Benchmark		Code		
#	Name	Kv	#	Name	Kv	ID	Case	Post-Contingency	Frequency		Post-Contingency	Pre-Contingency
987	BRITGOAB	69	6781	MORRIS	69	1	s03-105	233	1	233	0.058	2
3531	OCALA 1	230	6296	OCALA 1	230	1	s03-16	169	140	171	0.013	2
36	DADE	138	887	FRON TP	138	99	s03-1	156	140	155	1.333	1
3334	DLARPTTP	69	6904	BELVEW	69	1	s03-42	138	140	138	1.358	1
3334	DLARPTTP	69	3337	DALASMET	69	1	s03-12	138	140	136	1.245	1
3337	DALASMET	69	3366	DALLAS	69	1	s03-12	138	140	136	1.245	1
7013	MICCOSK	115	7014	MICCOSK	69	1	s03-12	134	140	134	1.341	1
6804	BRT ST T	138	6815	LEE	138	1	s03-1	133	140	134	1.319	1
2245	HIGGINS	115	2249	GRIFFIN	115	1	s03-35	130	6	148	0.920	2
530	SANPIPER	138	796	WH CTYTP	138	99	s03-122	125	2	125	0.372	2
649	BUCK-FPL	138	6805	BUCKHAM	138	1	s03-1	125	140	125	0.010	2
7027	SECICT56	13.2	7119	SEMINOLE	230	1	s03-12	124	140	125	1.211	1
3807	HUDSONTP	115	7075	HUDSON	115	1	s03-35	123	1	118	0.723	2
7075	HUDSON	115	7083	SEA P TP	115	1	s03-35	123	140	125	1.149	1
7026	HRDECT34	13.2	7121	CC PLANT	230	1	s03-3	118	140	121	1.172	1
213	SHERMAN	69	270	SHERMAN	230	1	s03-127	118	1	118	0.457	2
422	SN PLANT	115	2419	TURNER	115	1	s03-98	116	139	114	1.047	1
7025	HRDECT12	13.2	7121	CC PLANT	230	1	s03-12	116	140	116	1.130	1
3400	MARTIN W	69	3411	REDDICK	69	1	s03-116	115	116	118	1.032	1
3113	JASPER	115	11578	WGHTCHPL	115	1	s03-31	115	8	113	0.792	2
3670	DISSTON	115	3676	N EAST B	115	1	s03-35	114	1	116	0.897	2



Figure D-5. Post-Contingency Branch Loading for 2003 Summer TEC Dispatch (continued).

From Bus			To Bus					FPC Dispatch		Benchmark		Code
#	Name	Kv	#	Name	Kv	ID	Case	Post-Contingency	Frequency	Post-Contingency	Pre-Contingency	
3783	ZEPHYR N	69	3784	ZEPHYRHL	69	1	s03-35	112	1	118	0.842	2
263	INDN TWN	230	268	RANCH	230	99	s03-110	111	2	105	0.753	2
8860	SO GIB	230	8900	B BEND	230	1	s03-35	111	3	132	1.023	1
240	MIDWAY	138	796	WH CTYTP	138	1	s03-122	110	2	110	0.434	2
7116	HARDE 3	13.8	7121	CC PLANT	230	1	s03-100	108	140	108	1.079	1
6809	CORBETT	138	6815	LEE	138	1	s03-1	103	140	104	1.026	1
8700	GANNON	230	7916	GANNON 6	22	1	s03-12	102	19	102	0.999	2
8700	GANNON	230	7915	GANNON 5	20	1	s03-12	102	20	102	1.000	2
2032	HOWEYMTR	69	6915	HOWEY	69	1	s03-98	101	5	101	0.995	2

Code: 1 = Branch was overloaded in the pre-contingency (all lines in-service) benchmark case.
 2 = Branch was overloaded for at least one post-contingency benchmark case.
 3 = Branch was not overloaded in any benchmark case.



Figure D-6. Post-Contingency Branch Loading for 2003 Summer JEA Dispatch.

#	From Bus		To Bus		ID	Case	FPC Dispatch		Benchmark		Code	
	Name	Kv	#	Name			Kv	Post-Contingency	Frequency	Post-Contingency		Pre-Contingency
987	BRITGOAB	69	6781	MORRIS	69	1	s03-105	233	1	233	0.058	2
3531	OCALA 1	230	6296	OCALA 1	230	1	s03-39	170	141	171	0.013	2
36	DADE	138	887	FRON TP	138	99	s03-1	155	141	155	1.333	1
2245	HIGGINS	115	2249	GRIFFIN	115	1	s03-39	147	4	148	0.920	2
3334	DLARPTTP	69	6904	BELVEW	69	1	s03-42	138	141	138	1.358	1
8860	SO GIB	230	8900	B BEND	230	1	s03-39	134	139	132	1.023	1
7013	MICCOSK	115	7014	MICCOSK	69	1	s03-12	134	141	134	1.341	1
3334	DLARPTTP	69	3337	DALASMET	69	1	s03-39	133	141	136	1.245	1
3337	DALASMET	69	3366	DALLAS	69	1	s03-39	133	141	136	1.245	1
6804	BRT ST T	138	6815	LEE	138	1	s03-1	133	141	134	1.319	1
649	BUCK-FPL	138	6805	BUCKHAM	138	1	s03-1	125	141	125	0.010	2
530	SANPIPER	138	796	WH CTYTP	138	99	s03-122	125	2	125	0.372	2
7075	HUDSON	115	7083	SEA P TP	115	1	s03-39	125	141	125	1.149	1
3400	MARTIN W	69	3411	REDDICK	69	1	s03-116	123	135	118	1.032	1
7027	SECICT56	13.2	7119	SEMINOLE	230	1	s03-12	121	141	125	1.211	1
8500	11TH AVE	230	8860	SO GIB	230	1	s03-39	119	4	117	0.863	2
7026	HRDECT34	13.2	7121	CC PLANT	230	1	s03-3	119	141	121	1.172	1
213	SHERMAN	69	270	SHERMAN	230	1	s03-127	118	1	118	0.457	2
422	SN PLANT	115	2419	TURNER	115	1	s03-98	117	140	114	1.047	1
3807	HUDSONTP	115	7075	HUDSON	115	1	s03-35	117	1	118	0.723	2
3783	ZEPHYR N	69	3784	ZEPHYRHL	69	1	s03-39	116	2	118	0.842	2



Figure D-6. Post-Contingency Branch Loading for 2003 Summer JEA Dispatch (continued).

From Bus			To Bus			FPC Dispatch				Benchmark		Code
#	Name	Kv	#	Name	Kv	ID	Case	Post-Contingency	Frequency	Post-Contingency	Pre-Contingency	
7025	HRDECT12	13.2	7121	CC PLANT	230	1	s03-12	116	141	116	1.130	1
3670	DISSTON	115	3676	NEAST B	115	1	s03-39	116	2	116	0.897	2
240	MIDWAY	138	796	WH CTYTP	138	1	s03-122	110	2	110	0.434	2
263	INDN TWN	230	268	RANCH	230	99	s03-111	109	2	105	0.753	2
3113	JASPER	115	11578	WGHTCHPL	115	1	s03-31	109	3	113	0.792	2
8802	SEVEN8-T	69	8814	TWELFTH	69	1	s03-39	109	2	108	0.862	2
7116	HARDE 3	13.8	7121	CC PLANT	230	1	s03-113	108	141	108	1.079	1
8784	PT SUTTN	69	8786	BAYMET T	69	1	s03-39	108	2	106	0.850	2
8400	CHAPMAN	230	8700	GANNON	230	1	s03-39	105	1	104	0.776	2
8302	RIVER-N	69	8438	GTE-COLL	69	1	s03-39	104	1	103	0.877	2
6809	CORBETT	138	6815	LEE	138	1	s03-1	104	141	104	1.026	1
8700	GANNON	230	7916	GANNON 6	22	1	s03-12	102	20	102	0.999	2
8700	GANNON	230	7915	GANNON 5	20	1	s03-12	102	20	102	1.000	2
2032	HOWEYMTR	69	6915	HOWEY	69	1	s03-98	101	4	101	0.995	2

Code: 1 = Branch was overloaded in the pre-contingency (all lines in-service) benchmark case.
 2 = Branch was overloaded for at least one post-contingency benchmark case.
 3 = Branch was not overloaded in any benchmark case.



Figure D-7. Post-Contingency Branch Loading for 2003 Summer Southern FPL Dispatch.

#	From Bus		To Bus		ID	Case	FPC Dispatch		Benchmark		Code
	Name	Kv	Name	Kv			Post-Contingency	Frequency	Post-Contingency	Pre-Contingency	
987	BRITGOAB	69	6781 MORRIS	69	1	s03-105	233	1	233	0.058	2
3531	OCALA 1	230	6296 OCALA 1	230	1	s03-39	170	141	171	0.013	2
36	DADE	138	887 FRON TP	138	99	s03-1	158	141	155	1.333	1
2245	HIGGINS	115	2249 GRIFFIN	115	1	s03-39	150	4	148	0.920	2
3334	DLARPTTP	69	6904 BELVEW	69	1	s03-39	138	141	138	1.358	1
3334	DLARPTTP	69	3337 DALASMET	69	1	s03-39	137	141	136	1.245	1
3337	DALASMET	69	3366 DALLAS	69	1	s03-39	137	141	136	1.245	1
7013	MICCOSK	115	7014 MICCOSK	69	1	s03-12	134	141	134	1.341	1
6804	BRT ST T	138	6815 LEE	138	1	s03-1	134	141	134	1.319	1
8860	SO GIB	230	8900 B BEND	230	1	s03-39	128	8	132	1.023	1
7075	HUDSON	115	7083 SEA P TP	115	1	s03-39	125	141	125	1.149	1
7027	SECICT56	13.2	7119 SEMINOLE	230	1	s03-3	125	141	125	1.211	1
530	SANPIPER	138	796 WH CTYTP	138	99	s03-122	125	2	125	0.372	2
649	BUCK-FPL	138	6805 BUCKHAM	138	1	s03-1	125	141	125	0.010	2
7026	HRDECT34	13.2	7121 CC PLANT	230	1	s03-3	124	141	121	1.172	1
3783	ZEPHYR N	69	3784 ZEPHYRHL	69	1	s03-39	120	2	118	0.842	2
3807	HUDSONTP	115	7075 HUDSON	115	1	s03-35	120	2	118	0.723	2
213	SHERMAN	69	270 SHERMAN	230	1	s03-127	118	1	118	0.457	2
3670	DISSTON	115	3676 N EAST B	115	1	s03-39	117	2	116	0.897	2
3400	MARTIN W	69	3411 REDDICK	69	1	s03-116	116	119	118	1.032	1
7025	HRDECT12	13.2	7121 CC PLANT	230	1	s03-12	116	141	116	1.130	1



Figure D-7. Post-Contingency Branch Loading for 2003 Summer Southern FPL Dispatch (continued).

From Bus		To Bus		FPC Dispatch				Benchmark		Code		
#	Name	Kv	#	Name	Kv	ID	Case	Post-Contingency	Frequency		Post-Contingency	Pre-Contingency
422	SN PLANT	115	2419	TURNER	115	1	s03-98	115	138	114	1.047	1
3113	JASPER	115	11578	WGHTCHPL	115	1	s03-31	115	7	113	0.792	2
263	INDN TWN	230	268	RANCH	230	99	s03-110	114	2	105	0.753	2
8500	11TH AVE	230	8860	SO GIB	230	1	s03-39	114	2	117	0.863	2
240	MIDWAY	138	796	WH CTYTP	138	1	s03-122	110	2	110	0.434	2
7116	HARDE 3	13.8	7121	CC PLANT	230	1	s03-1	108	141	108	1.079	1
8802	SEVEN8-T	69	8814	TWELFTH	69	1	s03-39	108	1	108	0.862	2
8784	PT SUTTN	69	8786	BAYMET T	69	1	s03-39	104	1	106	0.850	2
6809	CORBETT	138	6815	LEE	138	1	s03-1	104	141	104	1.026	1
8400	CHAPMAN	230	8700	GANNON	230	1	s03-39	103	1	104	0.776	2
8302	RIVER-N	69	8438	GTE-COLL	69	1	s03-39	102	1	103	0.877	2
8700	GANNON	230	7916	GANNON 6	22	1	s03-12	102	19	102	0.999	2
8700	GANNON	230	7915	GANNON 5	20	1	s03-12	102	20	102	1.000	2
2032	HOWEYMTR	69	6915	HOWEY	69	1	s03-98	101	7	101	0.995	2

Code: 1 = Branch was overloaded in the pre-contingency (all lines in-service) benchmark case.
 2 = Branch was overloaded for at least one post-contingency benchmark case.
 3 = Branch was not overloaded in any benchmark case.



Figure D-8. Post-Contingency Branch Loading for 2003 Summer Northern FPL Dispatch.

From Bus			To Bus			FPC Dispatch				Benchmark		Code
#	Name	Kv	#	Name	Kv	ID	Case	Post-Contingency	Frequency	Post-Contingency	Pre-Contingency	
987	BRITGOAB	69	6781	MORRIS	69	1	s03-10	233	1	233	0.058	2
3531	OCALA 1	230	6296	OCALA 1	230	1	s03-39	170	99	171	0.013	2
36	DADE	138	887	FRON TP	138	99	s03-1	155	99	155	1.333	1
2245	HIGGINS	115	2249	GRIFFIN	115	1	s03-39	146	3	148	0.920	2
3334	DLARPTTP	69	6904	BELVEW	69	1	s03-42	138	99	138	1.358	1
3334	DLARPTTP	69	3337	DALASMET	69	1	s03-39	135	99	136	1.245	1
3337	DALASMET	69	3366	DALLAS	69	1	s03-39	135	99	136	1.245	1
7013	MICCOSK	115	7014	MICCOSK	69	1	s03-30	134	99	134	1.341	1
8860	SO GIB	230	8900	B BEND	230	1	s03-39	134	96	132	1.023	1
6804	BRT ST T	138	6815	LEE	138	1	s03-1	133	99	134	1.319	1
530	SANPIPER	138	796	WH CTYTP	138	99	s03-12	125	2	125	0.372	2
649	BUCK-FPL	138	6805	BUCKHAM	138	1	s03-1	125	99	125	0.010	2
7075	HUDSON	115	7083	SEA P TP	115	1	s03-39	125	99	125	1.149	1
7027	SECICT56	13.2	7119	SEMINOLE	230	1	s03-3	125	99	125	1.211	1
7026	HRDECT34	13.2	7121	CC PLANT	230	1	s03-3	119	99	121	1.172	1
8500	11TH AVE	230	8860	SO GIB	230	1	s03-39	119	3	117	0.863	2
213	SHERMAN	69	270	SHERMAN	230	1	s03-12	118	1	118	0.457	2
3807	HUDSONTP	115	7075	HUDSON	115	1	s03-35	117	1	118	0.723	2
3783	ZEPHYR N	69	3784	ZEPHYRHL	69	1	s03-39	116	2	118	0.842	2
3670	DISSTON	115	3676	N EAST B	115	1	s03-39	116	2	116	0.897	2
7025	HRDECT12	13.2	7121	CC PLANT	230	1	s03-43	115	99	116	1.130	1



Figure D-8. Post-Contingency Branch Loading for 2003 Summer Northern FPL Dispatch (continued).

#	From Bus		To Bus		ID	Case	FPC Dispatch		Benchmark		Code	
	Name	Kv	#	Name			Kv	Post-Contingency	Frequency	Post-Contingency		Pre-Contingency
422	SN PLANT	115	2419	TURNER	115	1	s03-98	114	97	114	1.047	1
3113	JASPER	115	11578	WGHTCHPL	115	1	s03-31	113	7	113	0.792	2
240	MIDWAY	138	796	WH CTYTP	138	1	s03-12	110	2	110	0.434	2
3400	MARTIN W	69	3411	REDDICK	69	1	s03-39	109	83	109	1.032	1
263	INDN TWN	230	268	RANCH	230	99	s03-11	109	1	105	0.753	2
7116	HARDE 3	13.8	7121	CC PLANT	230	1	s03-21	108	99	108	1.079	1
8802	SEVEN8-T	69	8814	TWELFTH	69	1	s03-39	108	2	108	0.862	2
8784	PT SUTTN	69	8786	BAYMET T	69	1	s03-39	107	2	106	0.850	2
8400	CHAPMAN	230	8700	GANNON	230	1	s03-39	104	1	104	0.776	2
6809	CORBETT	138	6815	LEE	138	1	s03-1	104	99	104	1.026	1
8302	RIVER-N	69	8438	GTE-COLL	69	1	s03-39	104	1	103	0.877	2
8700	GANNON	230	7916	GANNON 6	22	1	s03-12	102	19	102	0.999	2
8700	GANNON	230	7915	GANNON 5	20	1	s03-12	102	19	102	1.000	2
2032	HOWEYMTR	69	6915	HOWEY	69	1	s03-39	101	6	101	0.995	2

Code: 1 = Branch was overloaded in the pre-contingency (all lines in-service) benchmark case.
 2 = Branch was overloaded for at least one post-contingency benchmark case.
 3 = Branch was not overloaded in any benchmark case.



Figure D-9. Post-Contingency Branch Loading for 2003 Summer FPC Dispatch.

From Bus			To Bus			FPC Dispatch				Benchmark		Code
#	Name	Kv	#	Name	Kv	ID	Case	Post-Contingency	Frequency	Post-Contingency	Pre-Contingency	
987	BRITGOAB	69	6781	MORRIS	69	1	s03-10	233	1	233	0.058	2
3531	OCALA 1	230	6296	OCALA 1	230	1	s03-16	169	98	171	0.013	2
36	DADE	138	887	FRON TP	138	99	s03-1	156	98	155	1.333	1
3334	DLARPTTP	69	3337	DALASMET	69	1	s03-43	139	98	136	1.245	1
3337	DALASMET	69	3366	DALLAS	69	1	s03-43	139	98	136	1.245	1
3334	DLARPTTP	69	6904	BELVEW	69	1	s03-42	138	98	138	1.358	1
7013	MICCOSK	115	7014	MICCOSK	69	1	s03-3	134	98	134	1.341	1
6804	BRT ST T	138	6815	LEE	138	1	s03-1	133	98	134	1.319	1
8860	SO GIB	230	8900	B BEND	230	1	s03-35	128	96	132	1.023	1
2245	HIGGINS	115	2249	GRIFFIN	115	1	s03-35	126	8	148	0.920	2
530	SANPIPER	138	796	WH CTYTP	138	99	s03-12	125	2	125	0.372	2
649	BUCK-FPL	138	6805	BUCKHAM	138	1	s03-1	125	98	125	0.010	2
7027	SECICT56	13.2	7119	SEMINOLE	230	1	s03-3	125	98	125	1.211	1
7075	HUDSON	115	7083	SEA P TP	115	1	s03-35	121	98	125	1.149	1
422	SN PLANT	115	2419	TURNER	115	1	s03-98	119	98	114	1.047	1
7026	HRDECT34	13.2	7121	CC PLANT	230	1	s03-3	118	98	121	1.172	1
213	SHERMAN	69	270	SHERMAN	230	1	s03-12	118	1	118	0.457	2
3113	JASPER	115	11578	WGHTCHPL	115	1	s03-31	117	8	113	0.792	2
7025	HRDECT12	13.2	7121	CC PLANT	230	1	s03-43	115	98	116	1.130	1
3807	HUDSONTP	115	7075	HUDSON	115	1	s03-35	114	1	118	0.723	2
8500	11TH AVE	230	8860	SO GIB	230	1	s03-35	112	3	117	0.863	2



Figure D-9. Post-Contingency Branch Loading for 2003 Summer FPC Dispatch (continued).

#	From Bus		To Bus		ID	Case	FPC Dispatch		Benchmark		Code	
	Name	Kv	#	Name			Kv	Post-Contingency	Frequency	Post-Contingency		Pre-Contingency
240	MIDWAY	138	796	WH CTYTP	138	1	s03-12	110	2	110	0.434	2
263	INDN TWN	230	268	RANCH	230	99	s03-11	110	1	105	0.753	2
3670	DISSTON	115	3676	N EAST B	115	1	s03-35	109	1	116	0.897	2
7116	HARDE 3	13.8	7121	CC PLANT	230	1	s03-21	108	98	108	1.079	1
3400	MARTIN W	69	3411	REDDICK	69	1	s03-46	105	82	118	1.032	1
3783	ZEPHYR N	69	3784	ZEPHYRHL	69	1	s03-35	104	1	118	0.842	2
6809	CORBETT	138	6815	LEE	138	1	s03-1	104	98	104	1.026	1
8802	SEVEN8-T	69	8814	TWELFTH	69	1	s03-35	103	1	108	0.862	2
8784	PT SUTTN	69	8786	BAYMET T	69	1	s03-35	103	1	106	0.850	2
8700	GANNON	230	7916	GANNON 6	22	1	s03-12	102	18	102	0.999	2
8700	GANNON	230	7915	GANNON 5	20	1	s03-12	102	18	102	1.000	2
2032	HOWEYMTR	69	6915	HOWEY	69	1	s03-98	101	5	101	0.995	2
3548	BRDG-DUM	500	3518	BRKRIDGE	230	1	s03-35	101	1	<100	0.273	3

Code: 1 = Branch was overloaded in the pre-contingency (all lines in-service) benchmark case.
 2 = Branch was overloaded for at least one post-contingency benchmark case.
 3 = Branch was not overloaded in any benchmark case.



Table D-10. Post-Contingency Voltage Violations for All 2003 Summer Dispatch Scenarios.

#	Name	kV	Case Name	Voltage Violation (pu)	Frequency
<i>TEC Dispatch:</i>					
NONE					
<i>JEA Dispatch:</i>					
467	POINSETT	230	s03-85	1.051	1
6724	DUCKPOND	115	s03-116	0.949	1
<i>Southern FPL Dispatch:</i>					
2244	E CLRWTR	115	s03-39	0.949	1
3476	TANGERIN	115	s03-39	0.949	1
3477	TANGR TP	115	s03-39	0.949	1
3910	TRI-CITY	115	s03-39	0.949	1
8400	CHAPMAN	230	s03-39	0.949	1
3802	HERITGTP	115	s03-39	0.948	1
3804	ELFERS	115	s03-39	0.948	1
3814	SVNSPGTP	115	s03-39	0.948	1
3453	BROOKSVL	115	s03-39	0.947	1
3473	SPGHL2TP	115	s03-39	0.947	1
7085	SEVN SPG	115	s03-39	0.947	1
7087	SPG HL 2	115	s03-39	0.947	1
<i>Northern FPL Dispatch:</i>					
NONE					
<i>FPC Dispatch:</i>					
NONE					



Figure D-11. Post-Contingency Branch Loading for 2003 Winter TEC Dispatch.

From Bus			To Bus			FPC Dispatch				Benchmark		Code
#	Name	Kv	#	Name	Kv	ID	Case	Post-Contingency	Frequency	Post-Contingency	Pre-Contingency	
987	BRITGOAB	69	6781	MORRIS	69	1	w03-105	232	1	232	0.054	2
3334	DLARPTTP	69	6904	BELVIEW	69	1	w03-39	214	141	213	2.080	1
3334	DLARPTTP	69	3337	DALASMET	69	1	w03-39	183	141	178	1.649	1
3337	DALASMET	69	3366	DALLAS	69	1	w03-39	183	141	178	1.649	1
7075	HUDSON	115	7083	SEA P TP	115	1	w03-39	180	141	176	1.623	1
7013	MICCOSK	115	7014	MICCOSK	69	1	w03-12	158	141	158	1.581	1
530	SANPIPER	138	796	WH CTYTP	138	99	w03-122	146	3	146	0.425	2
3531	OCALA 1	230	6296	OCALA 1	230	1	w03-39	143	141	144	0.013	2
213	SHERMAN	69	270	SHERMAN	230	1	w03-127	141	1	141	0.550	2
7083	SEA P TP	115	7084	SEA PNS	115	1	w03-39	134	141	131	1.208	1
8850	BELCRK	230	9050	PEBB	230	1	w03-39	133	131	120	0.902	2
3783	ZEPHYR N	69	3784	ZEPHYRHL	69	1	w03-39	132	7	125	0.929	2
7025	HRDECT12	13.2	7121	CC PLANT	230	1	w03-12	131	141	131	1.265	1
7026	HRDECT34	13.2	7121	CC PLANT	230	1	w03-12	131	141	131	1.265	1
288	ALICO	138	595	FTMYERTP	138	99	w03-80	129	3	129	0.897	2
3807	HUDSONTP	115	7075	HUDSON	115	1	w03-35	129	140	125	0.877	2
7027	SECICT56	13.2	7119	SEMINOLE	230	1	w03-12	129	141	129	1.265	1
240	MIDWAY	138	796	WH CTYTP	138	1	w03-60	129	3	128	0.505	2
3670	DISSTON	115	3676	N EAST B	115	1	w03-39	126	141	122	1.082	1
6809	CORBETT	138	6815	LEE	138	1	w03-113	125	141	125	1.225	1
309	FT MYERS	138	595	FTMYERTP	138	1	w03-80	125	3	125	0.925	2



Figure D-11. Post-Contingency Branch Loading for 2003 Winter TEC Dispatch (continued).

From Bus			To Bus			FPC Dispatch			Benchmark		Code	
#	Name	Kv	#	Name	Kv	ID	Case	Post-Contingency	Frequency	Post-Contingency		Pre-Contingency
8860	SO GIB	230	8900	B BEND	230	1	w03-39	125	3	132	1.003	1
7116	HARDE 3	13.8	7121	CC PLANT	230	1	w03-1	124	141	124	1.244	1
649	BUCK-FPL	138	6805	BUCKHAM	138	1	w03-80	124	141	124	0.013	2
288	ALICO	138	305	ESTERO	138	1	w03-74	123	140	123	1.063	1
3364	CONTL TP	69	3373	FEDRALTP	69	1	w03-39	121	1	114	0.752	2
309	FT MYERS	138	649	BUCK-FPL	138	1	w03-80	121	140	121	1.010	1
263	INDN TWN	230	268	RANCH	230	99	w03-110	120	2	113	0.784	2
8610	HAMPTN T	230	9050	PEBB	230	1	w03-39	119	3	109	0.836	2
8802	SEVEN8-T	69	8814	TWELFTH	69	1	w03-39	114	2	113	0.892	2
303	EDISON	138	309	FT MYERS	138	99	w03-80	113	2	113	0.872	2
3548	BRDG-DUM	500	3518	BRKRIDGE	230	1	w03-35	113	1	108	0.378	2
7906	BIGBGT2	13.2	8890	BIGBGT-T	230	1	w03-1	112	141	112	1.120	1
7907	BIGB GT3	13.2	8890	BIGBGT-T	230	1	w03-1	112	141	112	1.120	1
9000	POLKPLNT	230	9030	BRADLY T	230	1	w03-6	112	3	103	0.819	2
3363	COLEMAN	69	3373	FEDRALTP	69	1	w03-39	112	1	105	0.663	2
8500	11TH AVE	230	8860	SO GIB	230	1	w03-39	111	1	117	0.847	2
3530	ZEPHYR N	230	3783	ZEPHYR N	69	1	w03-39	111	1	106	0.855	2
283	ARCADIA	69	284	CHARLOTE	69	1	w03-21	110	141	110	1.075	1
266	MIDWAY	230	532	TURNPIKE	230	1	w03-65	110	1	109	0.703	2
4735	GREENLND	230	4985	SWTZRLND	230	1	w03-94	110	23	110	0.972	2
6803	BRNT STR	138	6804	BRT ST T	138	1	w03-113	109	141	108	1.059	1
97010	OKECHOBE	230	270	SHERMAN	230	1	w03-66	108	1	NA	0.121	3
8302	RIVER-N	69	8438	GTE-COLL	69	1	w03-39	108	2	110	0.939	2



Figure D-11. Post-Contingency Branch Loading for 2003 Winter TEC Dispatch (continued).

From Bus			To Bus			FPC Dispatch			Benchmark		Code	
#	Name	Kv	#	Name	Kv	ID	Case	Post-Contingency	Frequency	Post-Contingency		Pre-Contingency
265	MARTIN	230	97010	OKECHOBE	230	1	w03-67	108	1	NA	0.120	3
263	INDN TWN	230	582	BRIDGE	230	1	w03-72	108	1	105	0.618	2
3664	BARTOW 2	115	3676	N EAST B	115	1	w03-39	108	2	105	0.940	2
3664	BARTOW 2	115	3676	N EAST B	115	2	w03-39	108	2	105	0.940	2
2245	HIGGINS	115	2249	GRIFFIN	115	1	w03-39	107	1	102	0.639	2
8400	CHAPMAN	230	8700	GANNON	230	1	w03-39	107	1	109	0.809	2
8700	GANNON	230	8750	SR60-S T	230	1	w03-39	106	3	102	0.935	2
8700	GANNON	230	7916	GANNON 6	22	1	w03-1	106	141	106	1.058	1
351	ORANGE R	230	750	ALICO	230	99	w03-74	105	1	105	0.807	2
6904	BELVEW	69	6921	MARION O	69	1	w03-39	105	141	104	1.017	1
8308	RIVER-S	69	8324	FOWLER-E	69	1	w03-39	105	1	105	0.854	2
8662	MULB-S	69	9032	SANDHL-W	69	1	w03-39	105	1	<100	0.809	3
9401	VB SUB1	69	9404	VB SUB1	69	1	w03-119	105	141	105	1.043	1
6816	LEE	230	7121	CC PLANT	230	1	w03-21	104	3	108	0.992	2
36	DADE	138	887	FRON TP	138	99	w03-1	103	1	103	0.815	2
8316	FORT6 T	69	8438	GTE-COLL	69	1	w03-39	103	1	105	0.878	2
311	HARBOR	138	754	PUNTA TP	138	1	w03-6	103	1	<100	0.861	3
8710	GANNON	138	8700	GANNON	230	1	w03-39	103	1	101	0.796	2
2666	IC P3&4	13.8	2769	INTERCSN	69	1	w03-98	103	141	103	1.133	1
2667	IC P5&6	13.8	2769	INTERCSN	69	1	w03-98	103	141	103	1.133	1
8380	JUNEAU-E	138	8382	JUNEAU-E	69	1	w03-39	103	1	105	1.031	1
375	BALDWIN	115	769	MACDONT P	115	99	w03-28	102	3	101	0.968	2
8784	PT SUTTN	69	8786	BAYMET T	69	1	w03-39	102	1	105	0.828	2



Figure D-11. Post-Contingency Branch Loading for 2003 Winter TEC Dispatch (continued).

From Bus			To Bus			FPC Dispatch		Benchmark		Code		
#	Name	Kv	#	Name	Kv	ID	Case	Post-Contingency	Frequency		Post-Contingency	Pre-Contingency
3734	PASCO RR	13.8	3811	PASCO RR	115	1	w03-35	102	5	102	0.888	2
8700	GANNON	230	7915	GANNON 5	20	1	w03-1	102	141	102	1.015	1
8900	B BEND	230	7903	B BEND 3	22	1	w03-39	101	1	101	0.966	2
191	CITRUS	138	229	HARTMAN	138	1	w03-119	101	1	<100	0.400	3
191	CITRUS	138	240	MIDWAY	138	1	w03-119	101	1	<100	0.400	3
7118	SEM. 2	23	7119	SEMINOLE	230	1	w03-116	101	5	101	0.982	2
8900	B BEND	230	7901	B BEND 1	24	1	w03-39	101	1	100	0.952	3

Code: 1 = Branch was overloaded in the pre-contingency (all lines in-service) benchmark case.
 2 = Branch was overloaded for at least one post-contingency benchmark case.
 3 = Branch was not overloaded in any benchmark case.



Figure D-12. Post-Contingency Branch Loading for 2003 Winter JEA Dispatch.

From Bus			To Bus			FPC Dispatch				Benchmark		Code
#	Name	Kv	#	Name	Kv	ID	Case	Post-Contingency	Frequency	Post-Contingency	Pre-Contingency	
987	BRITGOAB	69	6781	MORRIS	69	1	w03-105	232	1	232	0.054	2
3334	DLARPTTP	69	6904	BELVEW	69	1	w03-39	212	141	213	2.080	1
3334	DLARPTTP	69	3337	DALASMET	69	1	w03-39	176	141	178	1.649	1
3337	DALASMET	69	3366	DALLAS	69	1	w03-39	176	141	178	1.649	1
7075	HUDSON	115	7083	SEA P TP	115	1	w03-39	175	141	176	1.623	1
7013	MICCOSK	115	7014	MICCOSK	69	1	w03-12	158	141	158	1.581	1
530	SANPIPER	138	796	WH CTYTP	138	99	w03-122	146	3	146	0.425	2
3531	OCALA 1	230	6296	OCALA 1	230	1	w03-39	145	141	144	0.013	2
213	SHERMAN	69	270	SHERMAN	230	1	w03-127	141	1	141	0.550	2
8860	SO GIB	230	8900	B BEND	230	1	w03-39	135	133	132	1.003	1
7025	HRDECT12	13.2	7121	CC PLANT	230	1	w03-12	131	141	131	1.265	1
7026	HRDECT34	13.2	7121	CC PLANT	230	1	w03-12	131	141	131	1.265	1
7083	SEA P TP	115	7084	SEA PNS	115	1	w03-39	131	141	131	1.208	1
288	ALICO	138	595	FTMYERTP	138	99	w03-80	129	3	129	0.897	2
7027	SECICT56	13.2	7119	SEMINOLE	230	1	w03-12	129	141	129	1.265	1
240	MIDWAY	138	796	WH CTYTP	138	1	w03-122	128	3	128	0.505	2
6809	CORBETT	138	6815	LEE	138	1	w03-113	125	141	125	1.225	1
309	FT MYERS	138	595	FTMYERTP	138	1	w03-80	125	3	125	0.925	2
7116	HARDE 3	13.8	7121	CC PLANT	230	1	w03-1	124	141	124	1.244	1
3783	ZEPHYR N	69	3784	ZEPHYRHL	69	1	w03-39	124	2	125	0.929	2
649	BUCK-FPL	138	6805	BUCKHAM	138	1	w03-80	124	141	124	0.013	2



Figure D-12. Post-Contingency Branch Loading for 2003 Winter JEA Dispatch (continued).

From Bus			To Bus			FPC Dispatch			Benchmark		Code	
#	Name	Kv	#	Name	Kv	ID	Case	Post-Contingency	Frequency	Post-Contingency		Pre-Contingency
3807	HUDSONTP	115	7075	HUDSON	115	1	w03-35	124	140	125	0.877	2
288	ALICO	138	305	ESTERO	138	1	w03-74	123	140	123	1.063	1
3670	DISSTON	115	3676	N EAST B	115	1	w03-39	122	141	122	1.082	1
309	FT MYERS	138	649	BUCK-FPL	138	1	w03-80	121	140	121	1.010	1
8500	11TH AVE	230	8860	SO GIB	230	1	w03-39	120	2	117	0.847	2
263	INDN TWN	230	268	RANCH	230	99	w03-110	118	2	113	0.784	2
8850	BELCRK	230	9050	PEBB	230	1	w03-39	118	3	120	0.902	2
8802	SEVEN8-T	69	8814	TWELFTH	69	1	w03-39	114	2	113	0.892	2
303	EDISON	138	309	FT MYERS	138	99	w03-80	113	2	113	0.872	2
3364	CONTL TP	69	3373	FEDRALTP	69	1	w03-39	112	1	114	0.752	2
7906	BIGBGT2	13.2	8890	BIGBGT-T	230	1	w03-1	112	141	112	1.120	1
7907	BIGB GT3	13.2	8890	BIGBGT-T	230	1	w03-1	112	141	112	1.120	1
8302	RIVER-N	69	8438	GTE-COLL	69	1	w03-39	111	3	110	0.939	2
283	ARCADIA	69	284	CHARLOTE	69	1	w03-21	110	141	110	1.075	1
8400	CHAPMAN	230	8700	GANNON	230	1	w03-39	110	1	109	0.809	2
266	MIDWAY	230	532	TURNPIKE	230	1	w03-65	110	1	109	0.703	2
97010	OKECHOBE	230	270	SHERMAN	230	1	w03-66	108	1	NA	0.121	3
6803	BRNT STR	138	6804	BRT ST T	138	1	w03-113	108	141	108	1.059	1
265	MARTIN	230	97010	OKECHOBE	230	1	w03-67	108	1	NA	0.120	3
8610	HAMPTN T	230	9050	PEBB	230	1	w03-39	108	1	109	0.836	2
263	INDN TWN	230	582	BRIDGE	230	1	w03-72	107	1	105	0.618	2
3548	BRDG-DUM	500	3518	BRKRIDGE	230	1	w03-35	107	1	108	0.378	2
8316	FORT6 T	69	8438	GTE-COLL	69	1	w03-39	106	1	105	0.878	2



Figure D-12. Post-Contingency Branch Loading for 2003 Winter JEA Dispatch (continued).

From Bus			To Bus			FPC Dispatch			Benchmark		Code	
#	Name	Kv	#	Name	Kv	ID	Case	Post-Contingency	Frequency	Post-Contingency		Pre-Contingency
8784	PT SUTTN	69	8786	BAYMET T	69	1	w03-39	106	1	105	0.828	2
8308	RIVER-S	69	8324	FOWLER-E	69	1	w03-39	106	1	105	0.854	2
8700	GANNON	230	7916	GANNON 6	22	1	w03-1	106	141	106	1.058	1
3530	ZEPHYR N	230	3783	ZEPHYR N	69	1	w03-39	105	1	106	0.855	2
8380	JUNEAU-E	138	8382	JUNEAU-E	69	1	w03-39	105	2	105	1.031	1
351	ORANGE R	230	750	ALICO	230	99	w03-74	105	1	105	0.807	2
6816	LEE	230	7121	CC PLANT	230	1	w03-113	105	6	108	0.992	2
9401	VB SUB1	69	9404	VB SUB1	69	1	w03-119	105	141	105	1.043	1
3664	BARTOW 2	115	3676	N EAST B	115	1	w03-39	104	1	105	0.940	2
3664	BARTOW 2	115	3676	N EAST B	115	2	w03-39	104	1	105	0.940	2
6904	BELVEW	69	6921	MARION O	69	1	w03-39	104	141	104	1.017	1
36	DADE	138	887	FRON TP	138	99	w03-1	103	1	103	0.815	2
2666	IC P3&4	13.8	2769	INTERCSN	69	1	w03-98	103	141	103	1.133	1
2667	IC P5&6	13.8	2769	INTERCSN	69	1	w03-98	103	141	103	1.133	1
3363	COLEMAN	69	3373	FEDRALTP	69	1	w03-39	103	1	105	0.663	2
8216	HYDEPK-N	69	8218	HYDEPK-S	69	1	w03-39	103	1	102	0.784	2
8710	GANNON	138	8700	GANNON	230	1	w03-39	102	1	101	0.796	2
191	CITRUS	138	229	HARTMAN	138	1	w03-119	102	1	<100	0.400	3
191	CITRUS	138	240	MIDWAY	138	1	w03-119	102	1	<100	0.400	3
2245	HIGGINS	115	2249	GRIFFIN	115	1	w03-39	102	1	102	0.639	2
8322	FOWLER	69	8324	FOWLER-E	69	1	w03-39	102	1	101	0.794	2
9000	POLKPLNT	230	9030	BRADLY T	230	1	w03-6	102	1	103	0.819	2
3734	PASCO RR	13.8	3811	PASCO RR	115	1	w03-39	102	1	102	0.888	2



Figure D-12. Post-Contingency Branch Loading for 2003 Winter JEA Dispatch (continued).

From Bus			To Bus					FPC Dispatch		Benchmark		Code
#	Name	Kv	#	Name	Kv	ID	Case	Post-Contingency	Frequency	Post-Contingency	Pre-Contingency	
8700	GANNON	230	7915	GANNON 5	20	1	w03-1	102	141	102	1.015	1
8900	B BEND	230	7903	B BEND 3	22	1	w03-39	101	1	101	0.966	2
8700	GANNON	230	8750	SR60-S T	230	1	w03-39	101	2	102	0.935	2
8900	B BEND	230	7904	B BEND4	22	1	w03-39	101	3	101	0.984	2
8310	RIVER-S	230	8308	RIVER-S	69	1	w03-39	101	1	<100	0.962	3
7118	SEM. 2	23	7119	SEMINOLE	230	1	w03-116	101	1	101	0.982	2

Code: 1 = Branch was overloaded in the pre-contingency (all lines in-service) benchmark case.
 2 = Branch was overloaded for at least one post-contingency benchmark case.
 3 = Branch was not overloaded in any benchmark case.



Figure D-13. Post-Contingency Branch Loading for 2003 Winter Southern FPL Dispatch.

From Bus			To Bus			FPC Dispatch				Benchmark		
#	Name	Kv	#	Name	Kv	ID	Case	Post-Contingency	Frequency	Post-Contingency	Pre-Contingency	Code
987	BRITGOAB	69	6781	MORRIS	69	1	w03-105	232	1	232	0.054	2
3334	DLARPTTP	69	6904	BELVEW	69	1	w03-39	213	141	213	2.080	1
3334	DLARPTTP	69	3337	DALASMET	69	1	w03-39	179	141	178	1.649	1
3337	DALASMET	69	3366	DALLAS	69	1	w03-39	179	141	178	1.649	1
7075	HUDSON	115	7083	SEA P TP	115	1	w03-39	176	141	176	1.623	1
7013	MICCOSK	115	7014	MICCOSK	69	1	w03-12	158	141	158	1.581	1
530	SANPIPER	138	796	WH CTYTP	138	99	w03-122	146	3	146	0.425	2
3531	OCALA 1	230	6296	OCALA 1	230	1	w03-39	144	141	144	0.013	2
213	SHERMAN	69	270	SHERMAN	230	1	w03-127	141	1	141	0.550	2
7083	SEA P TP	115	7084	SEA PNS	115	1	w03-39	131	141	131	1.208	1
7025	HRDECT12	13.2	7121	CC PLANT	230	1	w03-12	131	141	131	1.265	1
7026	HRDECT34	13.2	7121	CC PLANT	230	1	w03-12	131	141	131	1.265	1
8860	SO GIB	230	8900	B BEND	230	1	w03-39	131	6	132	1.003	1
288	ALICO	138	595	FTMYERTP	138	99	w03-80	129	3	129	0.897	2
240	MIDWAY	138	796	WH CTYTP	138	1	w03-122	129	3	128	0.505	2
7027	SECICT56	13.2	7119	SEMINOLE	230	1	w03-12	129	141	129	1.265	1
3783	ZEPHYR N	69	3784	ZEPHYRHL	69	1	w03-39	126	3	125	0.929	2
3807	HUDSONTP	115	7075	HUDSON	115	1	w03-35	126	140	125	0.877	2
6809	CORBETT	138	6815	LEE	138	1	w03-21	125	141	125	1.225	1
309	FT MYERS	138	595	FTMYERTP	138	1	w03-80	125	3	125	0.925	2
263	INDN TWN	230	268	RANCH	230	99	w03-110	125	4	113	0.784	2



Figure D-13. Post-Contingency Branch Loading for 2003 Winter Southern FPL Dispatch (continued).

From Bus			To Bus			FPC Dispatch				Benchmark		Code
#	Name	Kv	#	Name	Kv	ID	Case	Post-Contingency	Frequency	Post-Contingency	Pre-Contingency	
7116	HARDE 3	13.8	7121	CC PLANT	230	1	w03-1	124	141	124	1.244	1
649	BUCK-FPL	138	6805	BUCKHAM	138	1	w03-80	124	141	124	0.013	2
288	ALICO	138	305	ESTERO	138	1	w03-74	123	140	123	1.063	1
3670	DISSTON	115	3676	N EAST B	115	1	w03-39	122	141	122	1.082	1
8850	BELCRK	230	9050	PEBB	230	1	w03-39	122	3	120	0.902	2
309	FT MYERS	138	649	BUCK-FPL	138	1	w03-80	121	140	121	1.010	1
8500	11TH AVE	230	8860	SO GIB	230	1	w03-39	116	2	117	0.847	2
3364	CONTL TP	69	3373	FEDRALTP	69	1	w03-39	115	1	114	0.752	2
303	EDISON	138	309	FT MYERS	138	99	w03-80	113	2	113	0.872	2
8802	SEVEN8-T	69	8814	TWELFTH	69	1	w03-39	113	2	113	0.892	2
7906	BIGBGT2	13.2	8890	BIGBGT-T	230	1	w03-1	112	141	112	1.120	1
7907	BIGB GT3	13.2	8890	BIGBGT-T	230	1	w03-1	112	141	112	1.120	1
266	MIDWAY	230	532	TURNPIKE	230	1	w03-65	112	1	109	0.703	2
36	DADE	138	887	FRON TP	138	99	w03-1	111	1	103	0.815	2
8610	HAMPTN T	230	9050	PEBB	230	1	w03-39	111	2	109	0.836	2
283	ARCADIA	69	284	CHARLOTE	69	1	w03-113	110	141	110	1.075	1
4735	GREENLND	230	4985	SWTZRLND	230	1	w03-94	110	21	110	0.972	2
8302	RIVER-N	69	8438	GTE-COLL	69	1	w03-39	110	2	110	0.939	2
6816	LEE	230	7121	CC PLANT	230	1	w03-5	109	123	108	0.992	2
3548	BRDG-DUM	500	3518	BRKRIDGE	230	1	w03-35	109	1	108	0.378	2
263	INDN TWN	230	582	BRIDGE	230	1	w03-72	108	1	105	0.618	2
97010	OKECHOBE	230	270	SHERMAN	230	1	w03-66	108	1	NA	0.121	3
8400	CHAPMAN	230	8700	GANNON	230	1	w03-39	108	1	109	0.809	2



Figure D-13. Post-Contingency Branch Loading for 2003 Winter Southern FPL Dispatch (continued).

From Bus			To Bus			FPC Dispatch			Benchmark		Code	
#	Name	Kv	#	Name	Kv	ID	Case	Post-Contingency	Frequency	Post-Contingency		Pre-Contingency
6803	BRNT STR	138	6804	BRT ST T	138	1	w03-21	108	141	108	1.059	1
265	MARTIN	230	97010	OKECHOBE	230	1	w03-67	108	1	NA	0.120	3
3530	ZEPHYR N	230	3783	ZEPHYR N	69	1	w03-39	107	1	106	0.855	2
8700	GANNON	230	7916	GANNON 6	22	1	w03-1	106	141	106	1.058	1
3363	COLEMAN	69	3373	FEDRALTP	69	1	w03-39	106	1	105	0.663	2
8308	RIVER-S	69	8324	FOWLER-E	69	1	w03-39	105	1	105	0.854	2
351	ORANGE R	230	750	ALICO	230	99	w03-74	105	1	105	0.807	2
3664	BARTOW 2	115	3676	N EAST B	115	1	w03-39	105	2	105	0.940	2
3664	BARTOW 2	115	3676	N EAST B	115	2	w03-39	105	2	105	0.940	2
8316	FORT6 T	69	8438	GTE-COLL	69	1	w03-39	105	1	105	0.878	2
9401	VB SUB1	69	9404	VB SUB1	69	1	w03-119	105	141	105	1.043	1
8380	JUNEAU-E	138	8382	JUNEAU-E	69	1	w03-39	104	1	105	1.031	1
6904	BELVEW	69	6921	MARION O	69	1	w03-39	104	141	104	1.017	1
8784	PT SUTTN	69	8786	BAYMET T	69	1	w03-39	104	1	105	0.828	2
9000	POLKPLNT	230	9030	BRADLY T	230	1	w03-6	103	2	103	0.819	2
2666	IC P3&4	13.8	2769	INTERCSN	69	1	w03-98	103	141	103	1.133	1
2667	IC P5&6	13.8	2769	INTERCSN	69	1	w03-98	103	141	103	1.133	1
2245	HIGGINS	115	2249	GRIFFIN	115	1	w03-39	103	1	102	0.639	2
8700	GANNON	230	8750	SR60-S T	230	1	w03-39	103	2	102	0.935	2
3734	PASCO RR	13.8	3811	PASCO RR	115	1	w03-35	102	2	102	0.888	2
8700	GANNON	230	7915	GANNON 5	20	1	w03-1	102	141	102	1.015	1
8216	HYDEPK-N	69	8218	HYDEPK-S	69	1	w03-39	101	1	102	0.784	2
8900	B BEND	230	7903	B BEND 3	22	1	w03-39	101	1	101	0.966	2



Figure D-13. Post-Contingency Branch Loading for 2003 Winter Southern FPL Dispatch (continued).

From Bus			To Bus			FPC Dispatch			Benchmark		Code	
#	Name	Kv	#	Name	Kv	ID	Case	Post-Contingency	Frequency	Post-Contingency		Pre-Contingency
375	BALDWIN	115	769	MACDONTP	115	99	w03-28	101	2	101	0.968	2
7118	SEM. 2	23	7119	SEMINOLE	230	1	w03-116	101	6	101	0.982	2
8710	GANNON	138	8700	GANNON	230	1	w03-39	101	1	101	0.796	2
8900	B BEND	230	7904	B BEND4	22	1	w03-39	101	3	101	0.984	2
8322	FOWLER	69	8324	FOWLER-E	69	1	w03-39	101	1	101	0.794	2
8900	B BEND	230	7901	B BEND 1	24	1	w03-39	101	1	100	0.952	3

Code: 1 = Branch was overloaded in the pre-contingency (all lines in-service) benchmark case.
 2 = Branch was overloaded for at least one post-contingency benchmark case.
 3 = Branch was not overloaded in any benchmark case.



Figure D-14. Post-Contingency Branch Loading for 2003 Winter Northern FPL Dispatch.

From Bus			To Bus			FPC Dispatch				Benchmark		Code
#	Name	Kv	#	Name	Kv	ID	Case	Post-Contingency	Frequency	Post-Contingency	Pre-Contingency	
987	BRITGOAB	69	6781	MORRIS	69	1	w03-10	232	1	232	0.054	2
3334	DLARPTTP	69	6904	BELVEW	69	1	w03-39	213	99	213	2.080	1
3334	DLARPTTP	69	3337	DALASMET	69	1	w03-39	178	99	178	1.649	1
3337	DALASMET	69	3366	DALLAS	69	1	w03-39	178	99	178	1.649	1
7075	HUDSON	115	7083	SEA P TP	115	1	w03-39	176	99	176	1.623	1
7013	MICCOSK	115	7014	MICCOSK	69	1	w03-31	158	99	158	1.581	1
530	SANPIPER	138	796	WH CTYTP	138	99	w03-60	146	3	146	0.425	2
3531	OCALA 1	230	6296	OCALA 1	230	1	w03-39	143	99	144	0.013	2
213	SHERMAN	69	270	SHERMAN	230	1	w03-12	141	1	141	0.550	2
8860	SO GIB	230	8900	B BEND	230	1	w03-39	134	87	132	1.003	1
7083	SEA P TP	115	7084	SEA PNS	115	1	w03-39	131	99	131	1.208	1
7025	HRDECT12	13.2	7121	CC PLANT	230	1	w03-3	131	99	131	1.265	1
7026	HRDECT34	13.2	7121	CC PLANT	230	1	w03-3	131	99	131	1.265	1
288	ALICO	138	595	FTMYERTP	138	99	w03-80	129	3	129	0.897	2
7027	SECICT56	13.2	7119	SEMINOLE	230	1	w03-3	129	99	129	1.265	1
240	MIDWAY	138	796	WH CTYTP	138	1	w03-12	128	3	128	0.505	2
6809	CORBETT	138	6815	LEE	138	1	w03-21	125	99	125	1.225	1
309	FT MYERS	138	595	FTMYERTP	138	1	w03-80	125	3	125	0.925	2
7116	HARDE 3	13.8	7121	CC PLANT	230	1	w03-1	124	99	124	1.244	1
3807	HUDSONTP	115	7075	HUDSON	115	1	w03-35	124	98	125	0.877	2
3783	ZEPHYR N	69	3784	ZEPHYRHL	69	1	w03-39	124	2	125	0.929	2



Figure D-14. Post-Contingency Branch Loading for 2003 Winter Northern FPL Dispatch (continued).

From Bus			To Bus			FPC Dispatch			Benchmark		Code	
#	Name	Kv	#	Name	Kv	ID	Case	Post-Contingency	Frequency	Post-Contingency		Pre-Contingency
649	BUCK-FPL	138	6805	BUCKHAM	138	1	w03-80	124	99	124	0.013	2
288	ALICO	138	305	ESTERO	138	1	w03-74	123	99	123	1.063	1
3670	DISSTON	115	3676	N EAST B	115	1	w03-39	122	99	122	1.082	1
309	FT MYERS	138	649	BUCK-FPL	138	1	w03-80	121	98	121	1.010	1
8500	11TH AVE	230	8860	SO GIB	230	1	w03-39	119	2	117	0.847	2
8850	BELCRK	230	9050	PEBB	230	1	w03-39	117	3	120	0.902	2
303	EDISON	138	309	FT MYERS	138	99	w03-80	113	2	113	0.872	2
8802	SEVEN8-T	69	8814	TWELFTH	69	1	w03-39	113	2	113	0.892	2
3364	CONTL TP	69	3373	FEDRALTP	69	1	w03-39	112	1	114	0.752	2
7906	BIGBGT2	13.2	8890	BIGBGT-T	230	1	w03-1	112	99	112	1.120	1
7907	BIGB GT3	13.2	8890	BIGBGT-T	230	1	w03-1	112	99	112	1.120	1
4735	GREENLND	230	4985	SWTZRLND	230	1	w03-94	111	24	110	0.972	2
8302	RIVER-N	69	8438	GTE-COLL	69	1	w03-39	111	3	110	0.939	2
283	ARCADIA	69	284	CHARLOTE	69	1	w03-21	110	99	110	1.075	1
263	INDN TWN	230	268	RANCH	230	99	w03-11	110	1	113	0.784	2
266	MIDWAY	230	532	TURNPIKE	230	1	w03-65	110	1	109	0.703	2
8400	CHAPMAN	230	8700	GANNON	230	1	w03-39	109	1	109	0.809	2
97010	OKECHOBE	230	270	SHERMAN	230	1	w03-66	108	1	NA	0.121	3
6803	BRNT STR	138	6804	BRT ST T	138	1	w03-21	108	99	108	1.059	1
265	MARTIN	230	97010	OKECHOBE	230	1	w03-67	108	1	NA	0.120	3
263	INDN TWN	230	582	BRIDGE	230	1	w03-72	108	1	105	0.618	2
3548	BRDG-DUM	500	3518	BRKRIDGE	230	1	w03-35	107	1	108	0.378	2
8610	HAMPTN T	230	9050	PEBB	230	1	w03-39	107	1	109	0.836	2



Figure D-14. Post-Contingency Branch Loading for 2003 Winter Northern FPL Dispatch (continued).

From Bus			To Bus			FPC Dispatch				Benchmark		Code
#	Name	Kv	#	Name	Kv	ID	Case	Post-Contingency	Frequency	Post-Contingency	Pre-Contingency	
8316	FORT6 T	69	8438	GTE-COLL	69	1	w03-39	106	1	105	0.878	2
8700	GANNON	230	7916	GANNON 6	22	1	w03-1	106	99	106	1.058	1
8308	RIVER-S	69	8324	FOWLER-E	69	1	w03-39	106	1	105	0.854	2
8784	PT SUTTN	69	8786	BAYMET T	69	1	w03-39	106	1	105	0.828	2
3530	ZEPHYR N	230	3783	ZEPHYR N	69	1	w03-39	105	1	106	0.855	2
8380	JUNEAU-E	138	8382	JUNEAU-E	69	1	w03-39	105	2	105	1.031	1
351	ORANGE R	230	750	ALICO	230	99	w03-74	105	1	105	0.807	2
6816	LEE	230	7121	CC PLANT	230	1	w03-21	105	6	108	0.992	2
9401	VB SUB1	69	9404	VB SUB1	69	1	w03-11	105	99	105	1.043	1
6904	BELVEW	69	6921	MARION O	69	1	w03-39	104	99	104	1.017	1
191	CITRUS	138	229	HARTMAN	138	1	w03-11	104	1	0	0.400	3
191	CITRUS	138	240	MIDWAY	138	1	w03-11	104	1	0	0.400	3
3664	BARTOW 2	115	3676	N EAST B	115	1	w03-39	104	1	105	0.940	2
3664	BARTOW 2	115	3676	N EAST B	115	2	w03-39	104	1	105	0.940	2
2666	IC P3&4	13.8	2769	INTERCSN	69	1	w03-98	103	99	103	1.133	1
2667	IC P5&6	13.8	2769	INTERCSN	69	1	w03-98	103	99	103	1.133	1
36	DADE	138	887	FRON TP	138	99	w03-1	103	1	103	0.815	2
3363	COLEMAN	69	3373	FEDRALTP	69	1	w03-39	103	1	105	0.663	2
8216	HYDEPK-N	69	8218	HYDEPK-S	69	1	w03-39	102	1	102	0.784	2
3734	PASCO RR	13.8	3811	PASCO RR	115	1	w03-39	102	2	102	0.888	2
8700	GANNON	230	7915	GANNON 5	20	1	w03-1	102	99	102	1.015	1
8710	GANNON	138	8700	GANNON	230	1	w03-39	102	1	101	0.796	2
375	BALDWIN	115	769	MACDONTP	115	99	w03-28	101	2	101	0.968	2



Figure D-14. Post-Contingency Branch Loading for 2003 Winter Northern FPL Dispatch (continued).

From Bus			To Bus			FPC Dispatch			Benchmark		Code	
#	Name	Kv	#	Name	Kv	ID	Case	Post-Contingency	Frequency	Post-Contingency		Pre-Contingency
8322	FOWLER	69	8324	FOWLER-E	69	1	w03-39	101	1	101	0.794	2
7118	SEM. 2	23	7119	SEMINOLE	230	1	w03-11	101	5	101	0.982	2
8900	B BEND	230	7903	B BEND 3	22	1	w03-39	101	1	101	0.966	2
2245	HIGGINS	115	2249	GRIFFIN	115	1	w03-39	101	1	102	0.639	2
8900	B BEND	230	7904	B BEND4	22	1	w03-39	101	3	101	0.984	2
9000	POLKPLNT	230	9030	BRADLY T	230	1	w03-6	101	1	103	0.819	2
8700	GANNON	230	8750	SR60-S T	230	1	w03-39	101	2	102	0.935	2

Code: 1 = Branch was overloaded in the pre-contingency (all lines in-service) benchmark case.
 2 = Branch was overloaded for at least one post-contingency benchmark case.
 3 = Branch was not overloaded in any benchmark case.



Figure D-15. Post-Contingency Branch Loading for 2003 Winter FPC Dispatch.

From Bus			To Bus			FPC Dispatch			Benchmark		Code	
#	Name	Kv	#	Name	Kv	ID	Case	Post-Contingency	Frequency	Post-Contingency		Pre-Contingency
987	BRITGOAB	69	6781	MORRIS	69	1	w03-10	232	1	232	0.054	2
3334	DLARPTTP	69	6904	BELVEW	69	1	w03-39	213	99	213	2.080	1
3334	DLARPTTP	69	3337	DALASMET	69	1	w03-39	181	99	178	1.649	1
3337	DALASMET	69	3366	DALLAS	69	1	w03-39	181	99	178	1.649	1
7075	HUDSON	115	7083	SEA P TP	115	1	w03-39	175	99	176	1.623	1
7013	MICCOSK	115	7014	MICCOSK	69	1	w03-3	158	99	158	1.581	1
530	SANPIPER	138	796	WH CTYTP	138	99	w03-60	146	3	146	0.425	2
3531	OCALA 1	230	6296	OCALA 1	230	1	w03-39	143	99	144	0.013	2
213	SHERMAN	69	270	SHERMAN	230	1	w03-12	141	1	141	0.550	2
8860	SO GIB	230	8900	B BEND	230	1	w03-39	138	94	132	1.003	1
7083	SEA P TP	115	7084	SEA PNS	115	1	w03-39	131	99	131	1.208	1
7025	HRDECT12	13.2	7121	CC PLANT	230	1	w03-3	131	99	131	1.265	1
7026	HRDECT34	13.2	7121	CC PLANT	230	1	w03-3	131	99	131	1.265	1
288	ALICO	138	595	FTMYERTP	138	99	w03-80	129	3	129	0.897	2
7027	SECICT56	13.2	7119	SEMINOLE	230	1	w03-3	129	99	129	1.265	1
240	MIDWAY	138	796	WH CTYTP	138	1	w03-12	128	3	128	0.505	2
6809	CORBETT	138	6815	LEE	138	1	w03-21	125	99	125	1.225	1
309	FT MYERS	138	595	FTMYERTP	138	1	w03-80	125	3	125	0.925	2
3783	ZEPHYR N	69	3784	ZEPHYRHL	69	1	w03-39	125	2	125	0.929	2
7116	HARDE 3	13.8	7121	CC PLANT	230	1	w03-1	124	99	124	1.244	1
649	BUCK-FPL	138	6805	BUCKHAM	138	1	w03-80	124	99	124	0.013	2



Figure D-15. Post-Contingency Branch Loading for 2003 Winter FPC Dispatch (continued).

From Bus			To Bus			FPC Dispatch			Benchmark		Code	
#	Name	Kv	#	Name	Kv	ID	Case	Post-Contingency	Frequency	Post-Contingency		Pre-Contingency
8500	11TH AVE	230	8860	SO GIB	230	1	w03-39	123	3	117	0.847	2
288	ALICO	138	305	ESTERO	138	1	w03-74	123	99	123	1.063	1
3807	HUDSONTP	115	7075	HUDSON	115	1	w03-35	122	36	125	0.877	2
3670	DISSTON	115	3676	N EAST B	115	1	w03-39	122	99	122	1.082	1
309	FT MYERS	138	649	BUCK-FPL	138	1	w03-80	121	98	121	1.010	1
8850	BELCRK	230	9050	PEBB	230	1	w03-39	119	3	120	0.902	2
8802	SEVEN8-T	69	8814	TWELFTH	69	1	w03-39	116	2	113	0.892	2
3364	CONTL TP	69	3373	FEDRALTP	69	1	w03-39	115	1	114	0.752	2
303	EDISON	138	309	FT MYERS	138	99	w03-80	113	2	113	0.872	2
8302	RIVER-N	69	8438	GTE-COLL	69	1	w03-39	112	4	110	0.939	2
8400	CHAPMAN	230	8700	GANNON	230	1	w03-39	112	1	109	0.809	2
7906	BIGBGT2	13.2	8890	BIGBGT-T	230	1	w03-1	112	99	112	1.120	1
7907	BIGB GT3	13.2	8890	BIGBGT-T	230	1	w03-1	112	99	112	1.120	1
4735	GREENLND	230	4985	SWTZRLND	230	1	w03-94	111	24	110	0.972	2
263	INDN TWN	230	268	RANCH	230	99	w03-11	111	1	113	0.784	2
283	ARCADIA	69	284	CHARLOTE	69	1	w03-21	110	99	110	1.075	1
3548	BRDG-DUM	500	3518	BRKRIDGE	230	1	w03-35	110	1	108	0.378	2
266	MIDWAY	230	532	TURNPIKE	230	1	w03-65	110	1	109	0.703	2
97010	OKECHOBE	230	270	SHERMAN	230	1	w03-66	108	1	NA	0.121	3
6803	BRNT STR	138	6804	BRT ST T	138	1	w03-21	108	99	108	1.059	1
8610	HAMPTN T	230	9050	PEBB	230	1	w03-39	108	1	109	0.836	2
265	MARTIN	230	97010	OKECHOBE	230	1	w03-67	108	1	NA	0.120	3



Figure D-15. Post-Contingency Branch Loading for 2003 Winter FPC Dispatch (continued).

From Bus			To Bus			FPC Dispatch			Benchmark		Code	
#	Name	Kv	#	Name	Kv	ID	Case	Post-Contingency	Frequency	Post-Contingency		Pre-Contingency
8784	PT SUTTN	69	8786	BAYMET T	69	1	w03-39	108	1	105	0.828	2
8316	FORT6 T	69	8438	GTE-COLL	69	1	w03-39	108	1	105	0.878	2
263	INDN TWN	230	582	BRIDGE	230	1	w03-72	108	1	105	0.618	2
8308	RIVER-S	69	8324	FOWLER-E	69	1	w03-39	107	1	105	0.854	2
3530	ZEPHYR N	230	3783	ZEPHYR N	69	1	w03-39	106	1	106	0.855	2
8380	JUNEAU-E	138	8382	JUNEAU-E	69	1	w03-39	106	2	105	1.031	1
8700	GANNON	230	7916	GANNON 6	22	1	w03-1	106	99	106	1.058	1
3363	COLEMAN	69	3373	FEDRALTP	69	1	w03-39	105	1	105	0.663	2
351	ORANGE R	230	750	ALICO	230	99	w03-74	105	1	105	0.807	2
9401	VB SUB1	69	9404	VB SUB1	69	1	w03-11	105	99	105	1.043	1
6904	BELVEW	69	6921	MARION O	69	1	w03-39	105	99	104	1.017	1
8710	GANNON	138	8700	GANNON	230	1	w03-39	105	1	101	0.796	2
8216	HYDEPK-N	69	8218	HYDEPK-S	69	1	w03-39	104	1	102	0.784	2
3664	BARTOW 2	115	3676	N EAST B	115	1	w03-39	104	1	105	0.940	2
3664	BARTOW 2	115	3676	N EAST B	115	2	w03-39	104	1	105	0.940	2
6816	LEE	230	7121	CC PLANT	230	1	w03-21	104	6	108	0.992	2
2245	HIGGINS	115	2249	GRIFFIN	115	1	w03-39	104	1	102	0.639	2
36	DADE	138	887	FRON TP	138	99	w03-1	103	1	103	0.815	2
8322	FOWLER	69	8324	FOWLER-E	69	1	w03-39	103	1	101	0.794	2
2667	IC P5&6	13.8	2769	INTERCSN	69	1	w03-12	103	25	103	1.133	1
191	CITRUS	138	229	HARTMAN	138	1	w03-11	103	1	<100	0.400	3
191	CITRUS	138	240	MIDWAY	138	1	w03-11	103	1	<100	0.400	3
375	BALDWIN	115	769	MACDONTP	115	99	w03-28	103	3	101	0.968	2



Figure D-15. Post-Contingency Branch Loading for 2003 Winter FPC Dispatch (continued).

From Bus		To Bus					FPC Dispatch		Benchmark			
#	Name	Kv	#	Name	Kv	ID	Case	Post-Contingency	Frequency	Post-Contingency	Pre-Contingency	Code
2666	IC P3&4	13.8	2769	INTERCSN	69	1	w03-12	102	14	103	1.133	1
8310	RIVER-S	230	8308	RIVER-S	69	1	w03-39	102	1	<100	0.962	3
8700	GANNON	230	7915	GANNON 5	20	1	w03-1	102	99	102	1.015	1
9000	POLKPLNT	230	9030	BRADLY T	230	1	w03-6	101	1	103	0.819	2
8900	B BEND	230	7903	B BEND 3	22	1	w03-39	101	1	101	0.966	2
8700	GANNON	230	8750	SR60-S T	230	1	w03-39	101	2	102	0.935	2
7118	SEM. 2	23	7119	SEMINOLE	230	1	w03-11	101	6	101	0.982	2
8216	HYDEPK-N	69	8232	MATZ-N T	69	1	w03-39	101	1	<100	0.715	3
8900	B BEND	230	7904	B BEND4	22	1	w03-39	101	3	101	0.984	2

Code: 1 = Branch was overloaded in the pre-contingency (all lines in-service) benchmark case.
 2 = Branch was overloaded for at least one post-contingency benchmark case.
 3 = Branch was not overloaded in any benchmark case.



Table D-16. Post-Contingency Voltage Violations for All 2003 Summer Dispatch Scenarios.

#	Name	kV	Case Name	Voltage Violation (pu)	Frequency
<i>TEC Dispatch:</i>					
3478	TC RANCH	115	w03-39	0.949	1
549	OKEELNTA	138	w03-12	0.948	1
8200	HIMES	138	w03-39	0.948	1
3672	GATEWAY	115	w03-39	0.947	1
2244	E CLRWTR	115	w03-39	0.946	1
3910	TRI-CITY	115	w03-39	0.946	1
3450	BRKRIDGE	115	w03-39	0.945	1
3813	SVN SP B	115	w03-39	0.945	1
2242	BAYVIEW	115	w03-39	0.944	1
3463	HAMMCKTP	115	w03-39	0.944	1
2248	SAFETY H	115	w03-39	0.943	1
3452	BRK98 TP	115	w03-39	0.943	1
3464	HAMMOCK	115	w03-39	0.943	1
7082	ROYLHIGH	115	w03-39	0.943	1
8400	CHAPMAN	230	w03-39	0.943	1
2245	HIGGINS	115	w03-39	0.942	1
3451	BRKSVL W	115	w03-39	0.942	1
7103	SLVRTHRN	115	w03-39	0.941	1
3482	WEEKI SW	115	w03-39	0.940	1
3812	SVN SP A	115	w03-39	0.940	1
7092	WEEKIWCH	115	w03-39	0.940	1
3811	PASCO RR	115	w03-39	0.939	1
3474	SPGWD TP	115	w03-39	0.938	1
7095	SPRINGWD	115	w03-39	0.938	1
3814	SVNSPGTP	115	w03-39	0.937	1
3833	ANC COOL	230	w03-39	0.937	1
3834	ANCLOTE	230	w03-39	0.937	1
7085	SEVN SPG	115	w03-39	0.936	1
2247	OLDSMAR	115	w03-39	0.935	1



Table D-16. Post-Contingency Voltage Violations for All 2003 Summer Dispatch Scenarios (continued).

#	Name	kV	Case Name	Voltage Violation (pu)	Frequency
<i>TEC Dispatch:</i>					
3476	TANGERIN	115	w03-39	0.935	1
3477	TANGR TP	115	w03-39	0.935	1
3453	BROOKSVL	115	w03-39	0.934	1
3802	HERITGTP	115	w03-39	0.934	1
3804	ELFERS	115	w03-39	0.934	1
3473	SPGHL2TP	115	w03-39	0.933	1
7087	SPG HL 2	115	w03-39	0.933	1
3808	FORST LK	115	w03-39	0.932	1
3815	TARPN SP	115	w03-39	0.932	1
7078	PASCO TR	115	w03-39	0.932	1
7099	SEVN HLS	115	w03-39	0.932	1
3475	SPRGHLTP	115	w03-39	0.931	1
7086	SPG HL 1	115	w03-39	0.931	1
<i>JEA Dispatch:</i>					
463	DUVAL	230	w03-116	1.052	1
<i>Southern FPL Dispatch:</i>					
NONE					
<i>Northern FPL Dispatch:</i>					
NONE					
<i>FPC Dispatch:</i>					
NONE					



Figure D-17. Pre-Contingency Branch Loading for New Smyrna Beach Sensitivity Case (% of Rate 1).

Bus 1	kV	Bus 2	kV	ID	Area	Benchmark	New Smyrna Beach	New Smyrna Beach & Okeechobee
ARCADIA	69	CHARLOTE	69	1	1	108	108	107
BELVEW	69	DLARPTTP	69	1	2	208	208	208
BIGB GT3	13.2	BIGBGT-T	230	1	16	112	112	112
BIGBGT2	13.2	BIGBGT-T	230	1	16	112	112	112
BRNT STR	138	BRT ST T	138	1	1	106	106	106
BUCK-FPL	138	FT MYERS	138	1	1	101	101	101
CHARLOTE	69	CHARLOTE	138	1	1	119	119	119
CORBETT	138	LEE	138	1	1	123	122	122
DALASMET	69	DALLAS	69	1	2	165	166	166
DISSTON	115	N EAST B	115	1	2	108	110	108
DLARPTTP	69	DALASMET	69	1	2	165	166	166
ESTERO	138	ALICO	138	1	1	106	106	106
GANNON	230	GANNON 5	20	1	16	102	102	102
GANNON	230	GANNON 6	22	1	16	106	106	106
HARDE 3	13.8	CC PLANT	230	1	12	124	124	124
HRDECT12	13.2	CC PLANT	230	1	12	127	127	127
HRDECT34	13.2	CC PLANT	230	1	12	127	127	127
HUDSONTP	115	HUDSON	115	1	2	102	103	102
IC P3&4	13.8	INTERCSN	69	1	2	113	113	114
IC P5&6	13.8	INTERCSN	69	1	2	113	113	114
JUNEAU-E	138	JUNEAU-E	69	1	16	103	103	104
LAUD PL	230	LGT13-16	13.8	1	1	117	115	117
MARATHON	138	MARATHON	25	1	1	103	106	103
MARATHON	138	MARATHON	25	2	1	103	106	103
MARION O	69	BELVEW	69	1	2	102	102	102



Figure D-17. Pre-Contingency Branch Loading for New Smyrna Beach Sensitivity Case (% of Rate 1).

Bus 1	kV	Bus 2	kV	ID	Area	Benchmark	New Smyrna Beach	New Smyrna Beach & Okeechobee
MICCOSK	115	MICCOSK	69	1	2	158	158	158
PT EVGLD	230	PEGT1-4	13.8	1	1	108	108	108
PT EVGLD	230	PEGT5-8	13.8	2	1	108	108	108
PT EVGLD	230	PEGT9-12	13.8	3	1	108	108	108
PUTNAM	230	PUTN.1CT	13.8	1	1	110	107	107
PUTNAM	230	PUTN.1ST	13.8	1	1	120	117	118
PUTNAM	230	PUTN.2CT	13.8	1	1	110	107	107
PUTNAM	230	PUTN.2ST	13.8	1	1	120	117	118
RIVIERA	138	RIVIERA4	20	1	1	111	111	111
SEA P TP	115	HUDSON	115	1	2	162	163	162
SEA PNS	115	SEA P TP	115	1	2	121	121	121
SECICT56	13.2	SEMINOLE	230	1	12	127	127	127
SN PLANT	115	SANFORD3	18	1	1	<100	101	101
SO GIB	230	B BEND	230	1	16	100	<100	103
TGRBAY 1	18	TIGER PL	230	1	2	101	101	102
TGRBAY 2	13.8	TIGER PL	230	1	2	105	105	105
TUR P3&4	13.2	TURNER	115	1	2	108	108	108
VB SUB1	69	VB SUB1	69	1	17	104	105	104



Figure D-18. Pre-Contingency Voltage Violations for New Smyrna Beach Sensitivity Case.

Bus	kV	Area	Benchmark	New Smyrna and Okeechobee No. FPL Dispatch
B BEND	230.0	16	1.055	1.055
BIGBGT-T	230.0	16	1.056	1.055
CRYST R5	500.0	2	1.051	1.051
DUMMY 1	230.0	2	1.051	1.051
POINSETT	500.0	1	1.051	1.053
TIMB PN	115.0	2	0.945	0.942



Figure D-19. Post-Contingency Branch Loading for 2003 Winter New Smyrna Beach Sensitivity Case.

From Bus			To Bus			FPC Dispatch			Benchmark		Code	
#	Name	Kv	#	Name	Kv	ID	Case	Post-Contingency	Frequency	Post-Contingency		Pre-Contingency
987	BRITGOAB	69	6781	MORRIS	69	1	w03-g10	232	1	232	0.055	2
3334	DLARPTTP	69	6904	BELVEW	69	1	w03-g39	213	99	217	2.078	1
3334	DLARPTTP	69	3337	DALASMET	69	1	w03-g39	179	99	182	1.654	1
3337	DALASMET	69	3366	DALLAS	69	1	w03-g39	179	99	182	1.654	1
7075	HUDSON	115	7083	SEA P TP	115	1	w03-g39	176	99	185	1.618	1
7013	MICCOSK	115	7014	MICCOSK	69	1	w03-g31	158	99	158	1.581	1
530	SANPIPER	138	796	WH CTYTP	138	99	w03-g60	146	3	145	0.427	2
3531	OCALA 1	230	6296	OCALA 1	230	1	w03-g39	143	99	145	0.013	2
213	SHERMAN	69	270	SHERMAN	230	1	w03-g12	141	1	141	0.550	2
8860	SO GIB	230	8900	B BEND	230	1	w03-g39	134	88	136	0.992	2
7083	SEA P TP	115	7084	SEA PNS	115	1	w03-g39	131	99	138	1.204	1
7025	HRDECT12	13.2	7121	CC PLANT	230	1	w03-g3	131	99	131	1.837	1
7026	HRDECT34	13.2	7121	CC PLANT	230	1	w03-g3	131	99	131	1.837	1
288	ALICO	138	595	FTMYERTP	138	99	w03-g80	129	3	130	0.897	2
7027	SECICT56	13.2	7119	SEMINOLE	230	1	w03-g3	129	99	129	1.319	1
240	MIDWAY	138	796	WH CTYTP	138	1	w03-g12	128	3	128	0.506	2
6809	CORBETT	138	6815	LEE	138	1	w03-g21	125	99	126	1.224	1
309	FT MYERS	138	595	FTMYERTP	138	1	w03-g80	125	3	125	0.925	2
7116	HARDE 3	13.8	7121	CC PLANT	230	1	w03-g1	124	99	117	1.110	1
3807	HUDSONTP	115	7075	HUDSON	115	1	w03-g35	124	98	130	0.874	2
649	BUCK-FPL	138	6805	BUCKHAM	138	1	w03-g80	124	99	124	0.013	2



Figure D-19. Post-Contingency Branch Loading for 2003 Winter New Smyrna Beach Sensitivity Case (continued).

From Bus			To Bus			FPC Dispatch			Benchmark		Code	
#	Name	Kv	#	Name	Kv	ID	Case	Post-Contingency	Frequency	Post-Contingency		Pre-Contingency
3783	ZEPHYR N	69	3784	ZEPHYRHL	69	1	w03-g39	124	2	128	0.923	2
288	ALICO	138	305	ESTERO	138	1	w03-g74	123	99	123	1.063	1
3670	DISSTON	115	3676	N EAST B	115	1	w03-g39	122	99	135	1.070	1
309	FT MYERS	138	649	BUCK-FPL	138	1	w03-g80	121	98	121	1.010	1
8500	11TH AVE	230	8860	SO GIB	230	1	w03-g39	119	2	121	0.833	2
8850	BELCRK	230	9050	PEBB	230	1	w03-g39	117	3	122	0.898	2
303	EDISON	138	309	FT MYERS	138	99	w03-g80	113	2	114	0.872	2
8802	SEVEN8-T	69	8814	TWELFTH	69	1	w03-g39	113	2	116	0.883	2
3364	CONTL TP	69	3373	FEDRALTP	69	1	w03-g39	112	1	116	0.748	2
7906	BIGBGT2	13.2	8890	BIGBGT-T	230	1	w03-g1	112	99	112	1.769	1
7907	BIGB GT3	13.2	8890	BIGBGT-T	230	1	w03-g1	112	99	112	1.769	1
8302	RIVER-N	69	8438	GTE-COLL	69	1	w03-g39	111	3	113	0.926	2
283	ARCADIA	69	284	CHARLOTE	69	1	w03-g21	110	99	111	1.075	1
263	INDN TWN	230	268	RANCH	230	99	w03-g11	110	1	114	0.785	2
266	MIDWAY	230	532	TURNPIKE	230	1	w03-g65	110	1	109	0.703	2
8400	CHAPMAN	230	8700	GANNON	230	1	w03-g39	109	1	112	0.798	2
4735	GREENLND	230	4985	SWTZRLND	230	1	w03-g94	109	13	108	0.936	2
97010	OKECHOBE	230	270	SHERMAN	230	1	w03-g66	108	1	0	0.121	3
6803	BRNT STR	138	6804	BRT ST T	138	1	w03-g21	108	99	109	1.059	1
265	MARTIN	230	97010	OKECHOBE	230	1	w03-g67	108	1	0	0.121	3
263	INDN TWN	230	582	BRIDGE	230	1	w03-g72	108	1	105	0.619	2
3548	BRDG-DUM	500	3518	BRKRIDGE	230	1	w03-g35	107	1	108	0.378	2
8610	HAMPTN T	230	9050	PEBB	230	1	w03-g39	106	1	111	0.832	2



Figure D-19. Post-Contingency Branch Loading for 2003 Winter New Smyrna Beach Sensitivity Case (continued).

From Bus			To Bus			FPC Dispatch			Benchmark		Code	
#	Name	Kv	#	Name	Kv	ID	Case	Post-Contingency	Frequency	Post-Contingency		Pre-Contingency
8316	FORT6 T	69	8438	GTE-COLL	69	1	w03-g39	106	1	108	0.865	2
8700	GANNON	230	7916	GANNON 6	22	1	w03-g1	106	99	106	0.976	2
8308	RIVER-S	69	8324	FOWLER-E	69	1	w03-g39	106	1	109	0.840	2
8784	PT SUTTN	69	8786	BAYMET T	69	1	w03-g39	106	1	108	0.807	2
8380	JUNEAU-E	138	8382	JUNEAU-E	69	1	w03-g39	105	2	105	1.022	1
351	ORANGE R	230	750	ALICO	230	99	w03-g74	105	1	105	0.807	2
3530	ZEPHYR N	230	3783	ZEPHYR N	69	1	w03-g39	105	1	107	0.850	2
9401	VB SUB1	69	9404	VB SUB1	69	1	w03-g11	105	99	105	1.041	1
6816	LEE	230	7121	CC PLANT	230	1	w03-g21	105	6	109	0.987	2
6904	BELVEW	69	6921	MARION O	69	1	w03-g39	104	99	106	1.016	1
191	CITRUS	138	229	HARTMAN	138	1	w03-g11	104	1	0	0.401	3
191	CITRUS	138	240	MIDWAY	138	1	w03-g11	104	1	0	0.401	3
3664	BARTOW 2	115	3676	N EAST B	115	1	w03-g39	104	1	115	0.943	2
3664	BARTOW 2	115	3676	N EAST B	115	2	w03-g39	104	1	115	0.943	2
2666	IC P3&4	13.8	2769	INTERCSN	69	1	w03-g98	103	99	102	1.117	1
2667	IC P5&6	13.8	2769	INTERCSN	69	1	w03-g98	103	99	102	1.117	1
36	DADE	138	887	FRON TP	138	99	w03-g1	103	1	104	0.815	2
3363	COLEMAN	69	3373	FEDRALTP	69	1	w03-g39	103	1	107	0.658	2
8216	HYDEPK-N	69	8218	HYDEPK-S	69	1	w03-g39	102	1	105	0.770	2
375	BALDWIN	115	769	MACDONT P	115	99	w03-g28	102	2	102	0.970	2
3734	PASCO RR	13.8	3811	PASCO RR	115	1	w03-g39	102	2	0	1.541	1
8700	GANNON	230	7915	GANNON 5	20	1	w03-g1	102	99	102	1.041	1
8710	GANNON	138	8700	GANNON	230	1	w03-g39	102	1	102	0.788	2



Figure D-19. Post-Contingency Branch Loading for 2003 Winter New Smyrna Beach Sensitivity Case (continued).

From Bus			To Bus			FPC Dispatch			Benchmark		Code	
#	Name	Kv	#	Name	Kv	ID	Case	Post-Contingency	Frequency	Post-Contingency		Pre-Contingency
7118	SEM. 2	23	7119	SEMINOLE	230	1	w03-g11	101	6	101	0.978	2
8900	B BEND	230	7903	B BEND 3	22	1	w03-g39	101	1	101	0.936	2
8322	FOWLER	69	8324	FOWLER-E	69	1	w03-g39	101	1	104	0.780	2
8900	B BEND	230	7904	B BEND4	22	1	w03-g39	101	3	101	0.954	2
2245	HIGGINS	115	2249	GRIFFIN	115	1	w03-g39	101	1	104	0.635	2
8700	GANNON	230	8750	SR60-S T	230	1	w03-g39	101	2	103	0.931	2
9000	POLKPLNT	230	9030	BRADLY T	230	1	w03-g6	101	1	105	0.814	2
8310	RIVER-S	230	8308	RIVER-S	69	1	w03-g39	101	1	100	0.958	2

Code: 1 = Branch was overloaded in the pre-contingency (all lines in-service) benchmark case.
 2 = Branch was overloaded for at least one post-contingency benchmark case.
 3 = Branch was not overloaded in any benchmark case.



Table D-20. Post-Contingency Voltage Violations for New Smyrna Beach Sensitivity Case.

#	Name	kV	Case Name	Voltage Violation (pu)	Frequency
3555	CRYST RV	500	w03-g38	1.053	15
109	LEVEE	230	w03-g11	1.052	1
112	MIA EAST	230	w03-g11	1.052	1
356	DUVAL	500	w03-g11	1.051	1
469	SN PLANT	230	w03-g98	1.051	1
8870	RUSKIN T	230	w03-g11	1.051	1



Appendix E Stability Analysis Results

Tab	Description
1	TEC Dispatch, 2003 Summer
2	JEA Dispatch, 2003 Summer
3	Southern FPL Dispatch, 2003 Summer
4	Northern FPL Dispatch, 2003 Summer
5	FPC Dispatch, 2003 Summer
6	TEC Dispatch, 2003 Winter
7	JEA Dispatch, 2003 Winter
8	Southern FPL Dispatch, 2003 Winter
9	Northern FPL Dispatch, 2003 Winter
10	FPC Dispatch, 2003 Winter
11	New Smyrna Beach Sensitivity, Southern FPL Dispatch, 2003 Winter

3-phase, 5-cycle Fault at St. Lucie 230kV Bus, Trip St. Lucie #1 & GSU
 2003 Summer System

Machine & Interface Variables: (—) With Okeechobee TEC Dispatch, (...) Without

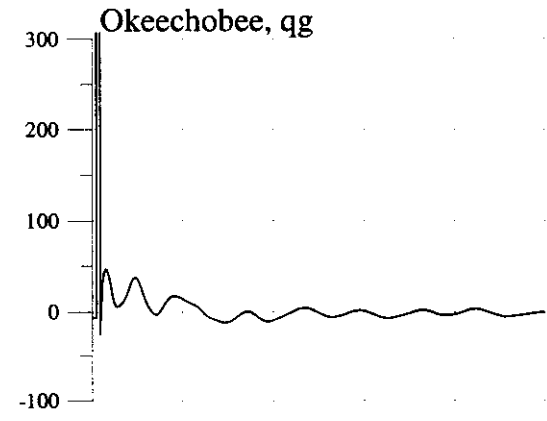
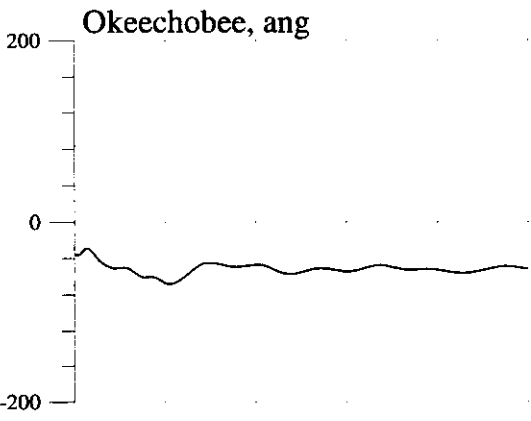
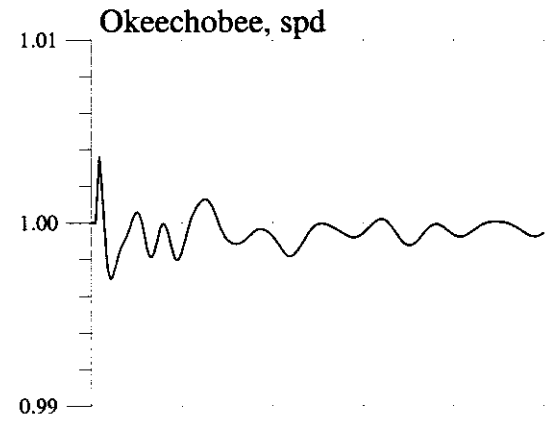
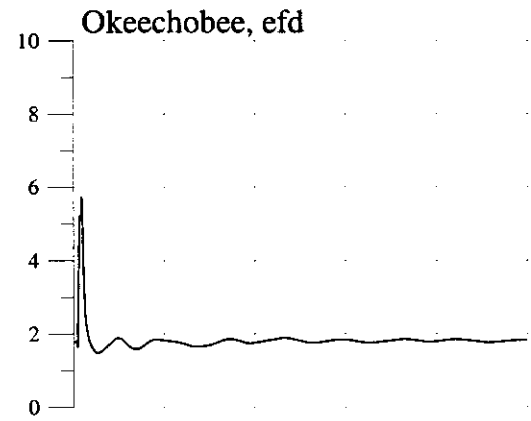
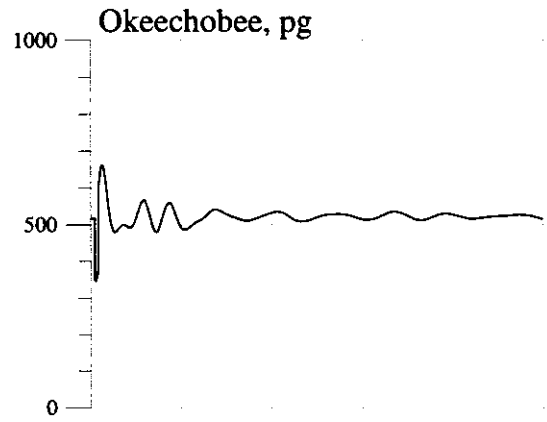
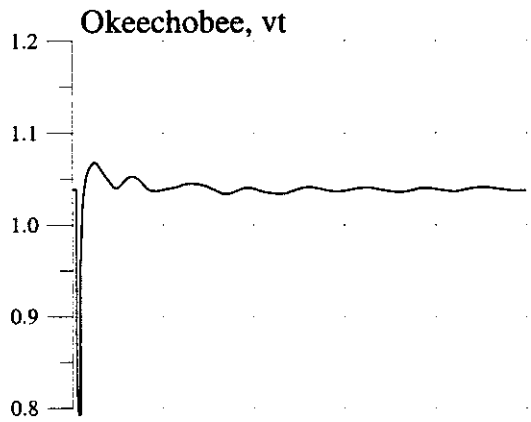

0 2 4 6 8 10

0 2 4 6 8 10

Time (Seconds)

Time (Seconds)



3-phase, 5-cycle Fault at St. Lucie 230kV Bus, Trip St. Lucie #1 & GSU
2003 Summer System

Machine & Interface Variables: (—) With Okeechobee TEC Dispatch, (...) Without

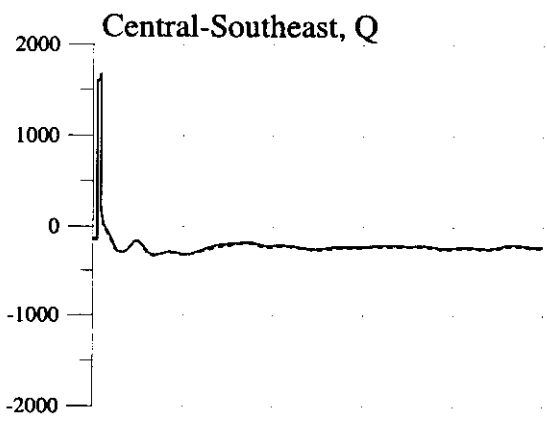
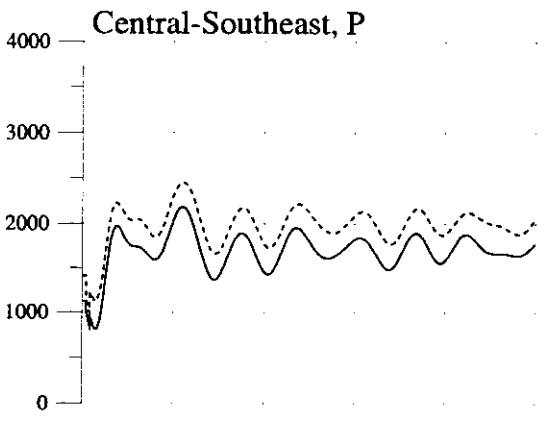
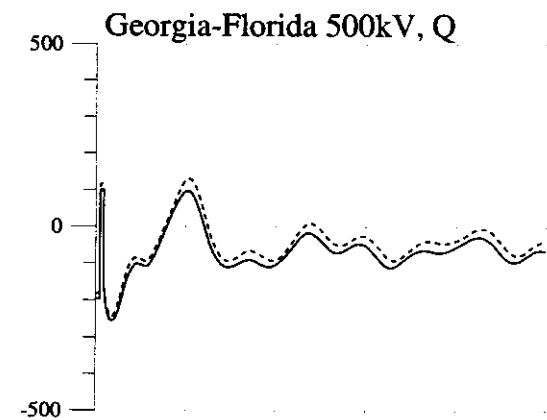
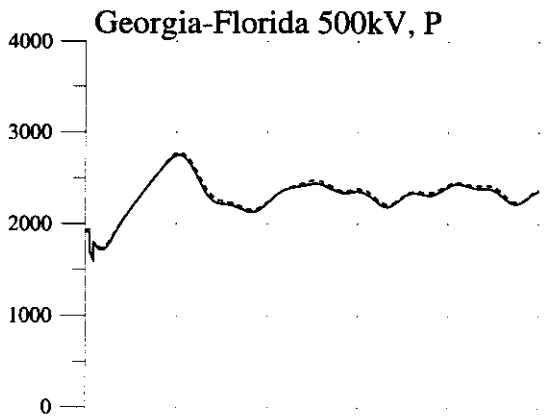
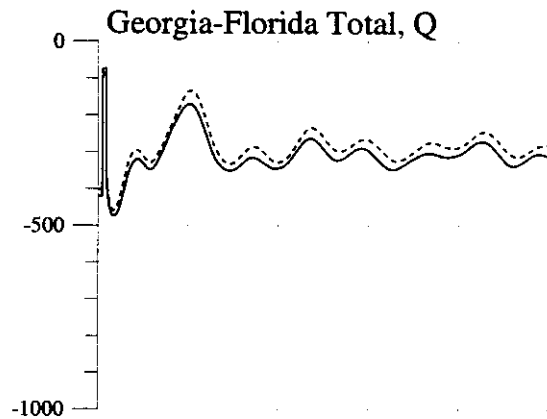
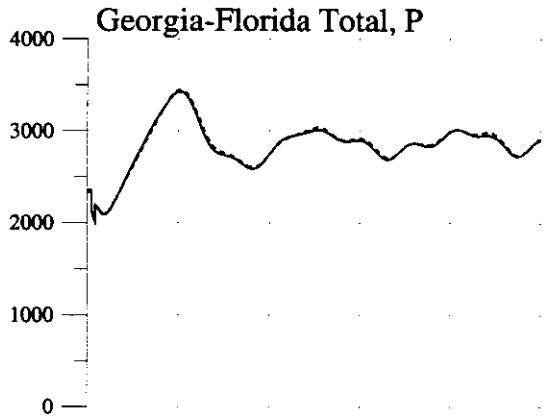

Time (Seconds)

Time (Seconds)



3-phase, 5-cycle Fault at St. Lucie 230kV Bus, Trip St. Lucie #1 & GSU
2003 Summer System

Machine Variables: (___) With Okeechobee TEC Dispatch, (...) Without

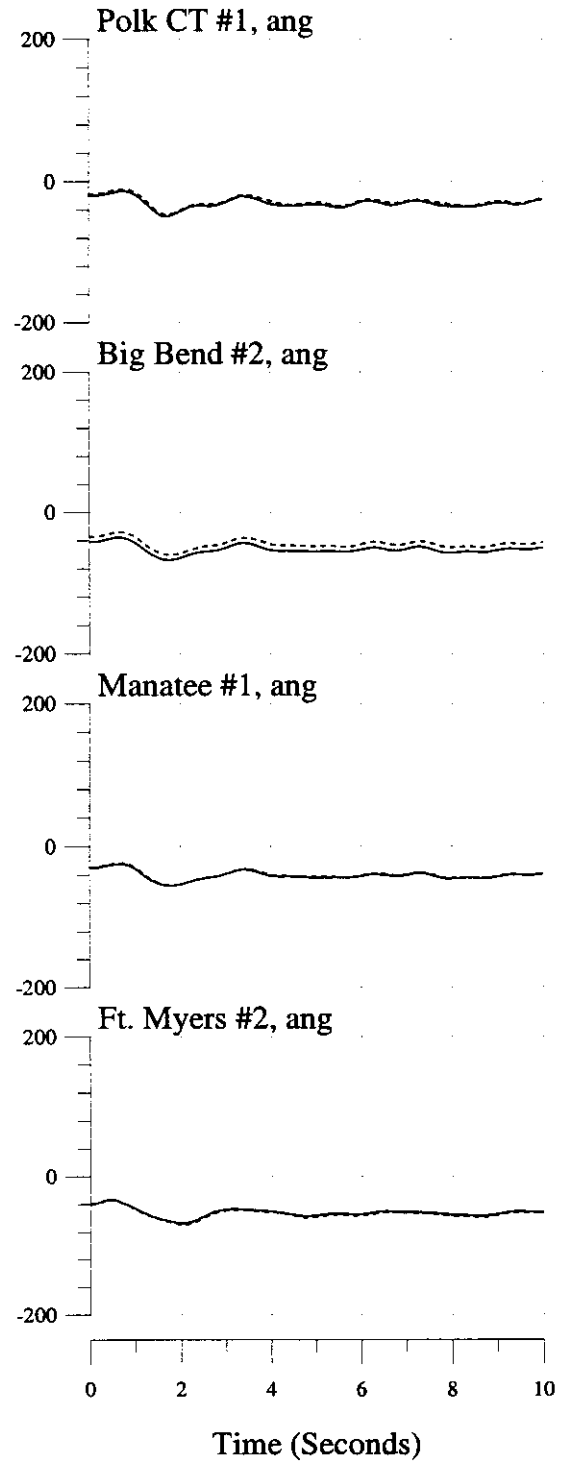
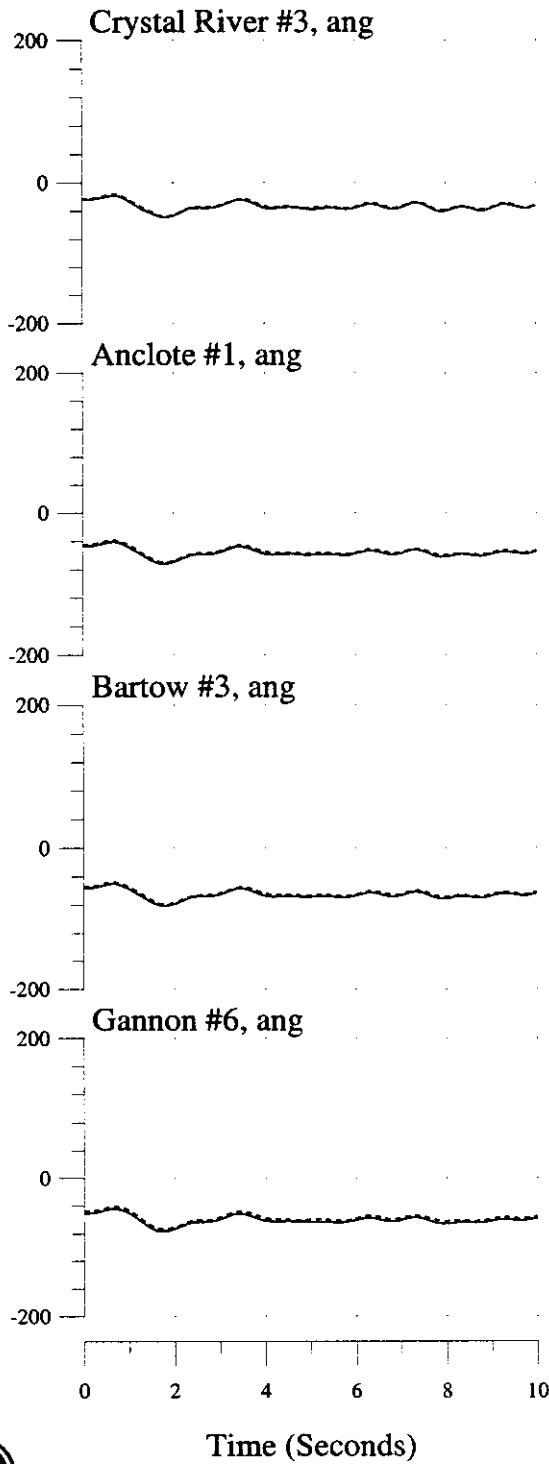

3-phase, 5-cycle Fault at St. Lucie 230kV Bus, Trip St. Lucie #1 & GSU
 2003 Summer System

Machine Variables: (—) With Okeechobee TEC Dispatch, (...) Without

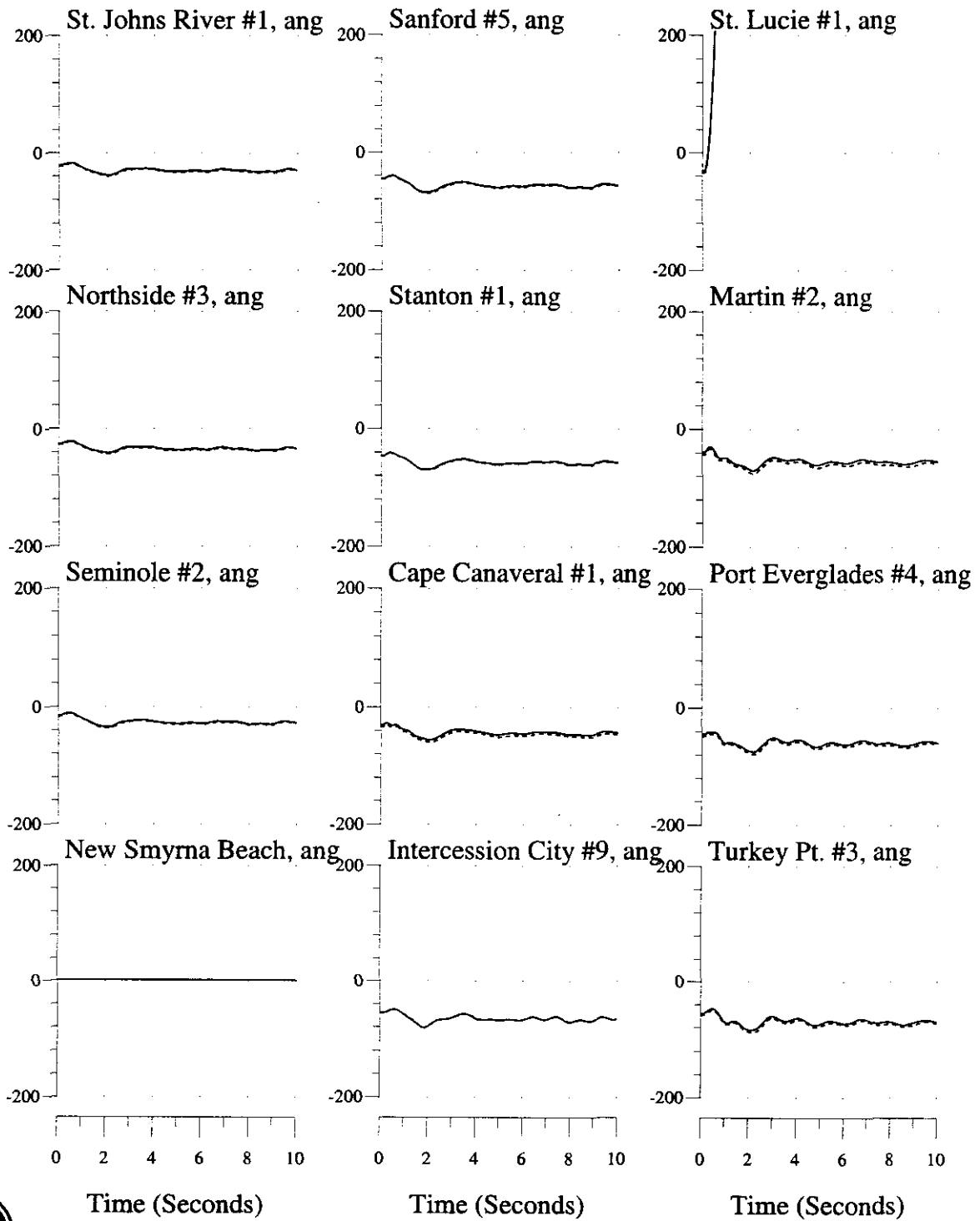

3-phase, 5-cycle Fault at St. Lucie 230kV Bus, Trip St. Lucie #1 & GSU
 2003 Summer System

Bus Variables: (—) With Okeechobee TEC Dispatch, (...) Without

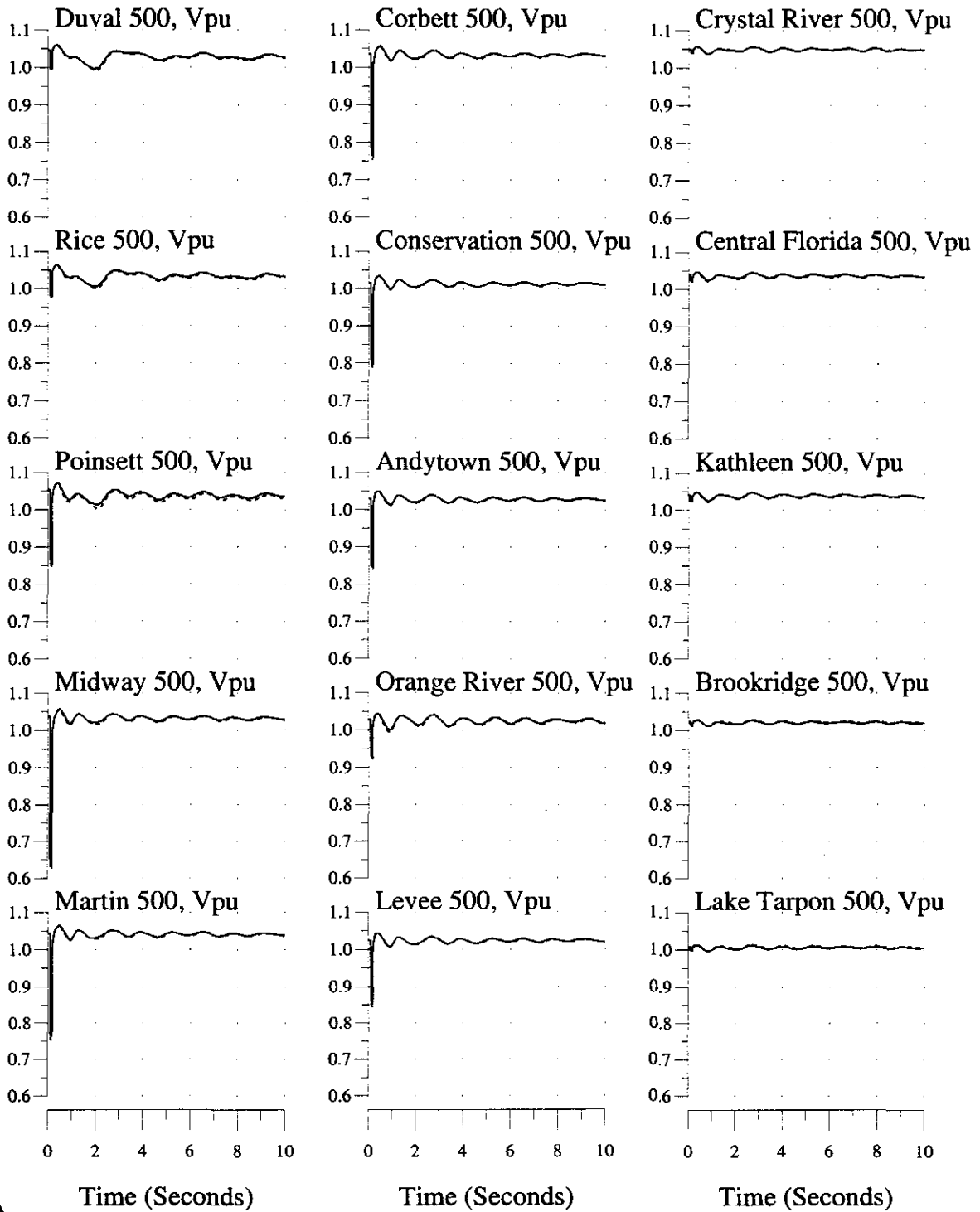

3-phase, 5-cycle Fault at St. Lucie 230kV Bus, Trip St. Lucie #1 & GSU
2003 Summer System

Bus Variables: (—) With Okeechobee TEC Dispatch, (...) Without

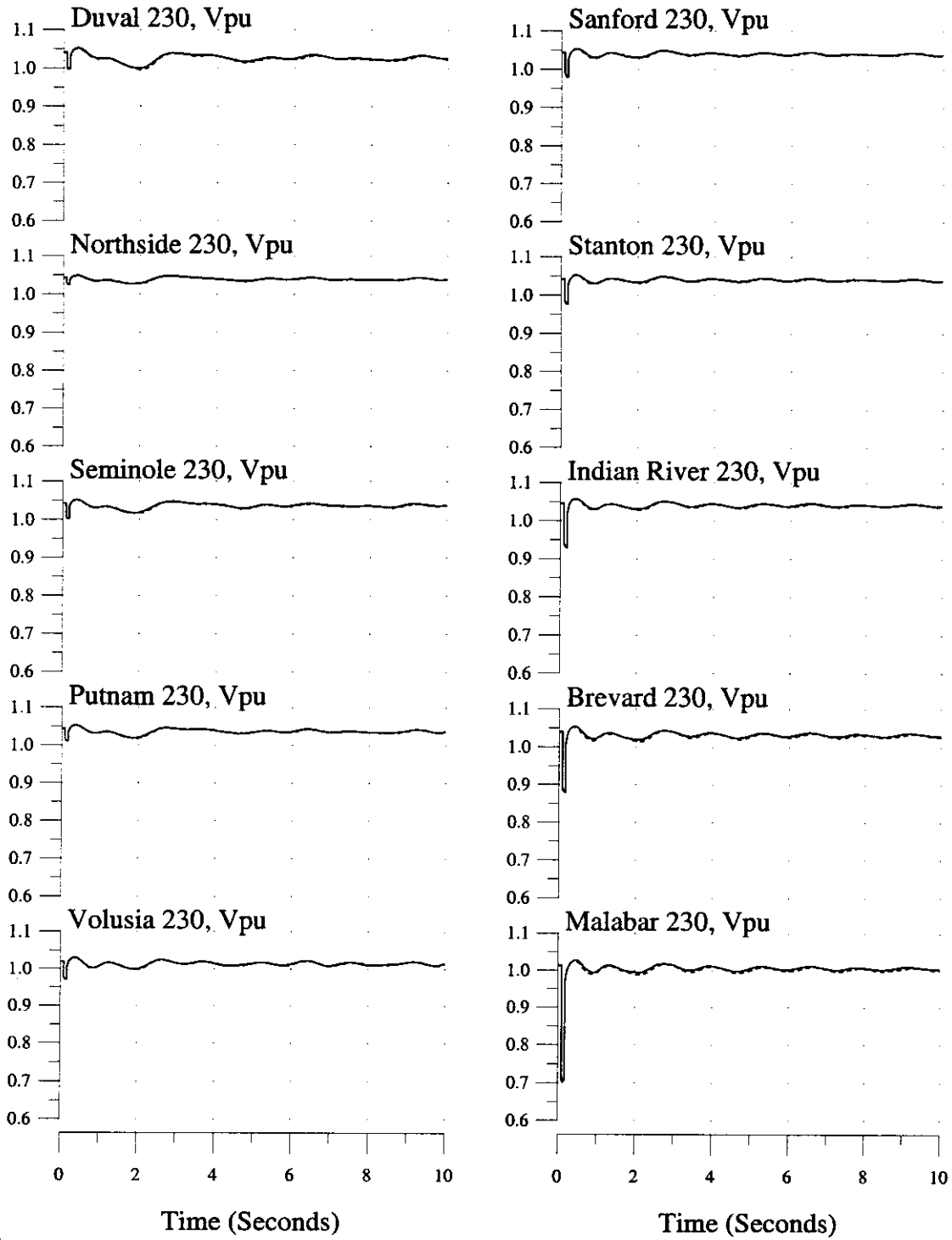

3-phase, 5-cycle Fault at St. Lucie 230kV Bus, Trip St. Lucie #1 & GSU
2003 Summer System

Bus Variables: (—) With Okeechobee TEC Dispatch, (...) Without

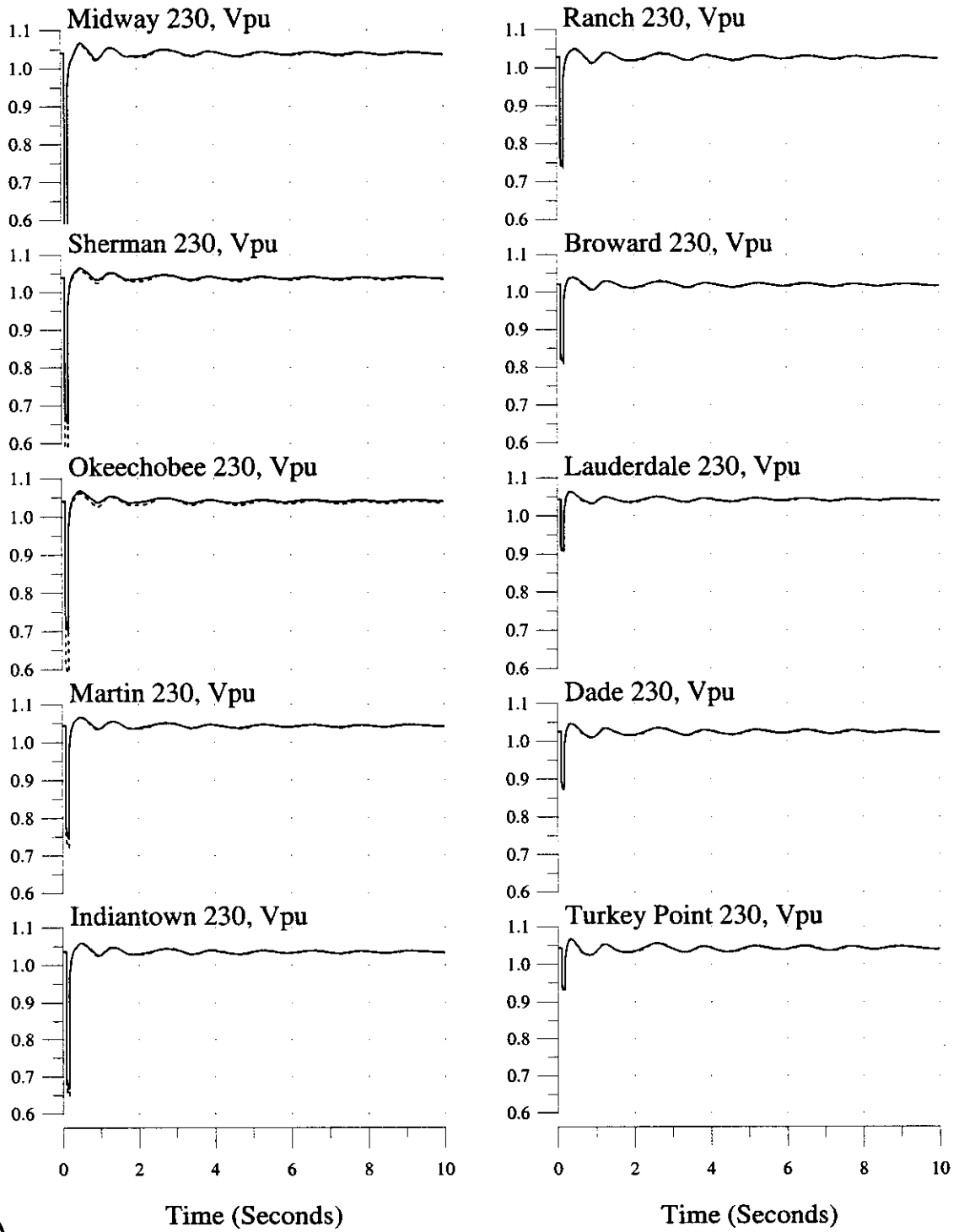

3-phase, 5-cycle Fault at St. Lucie 230kV Bus, Trip St. Lucie #1 & GSU
 2003 Summer System

Bus Variables: (—) With Okeechobee TEC Dispatch, (...) Without

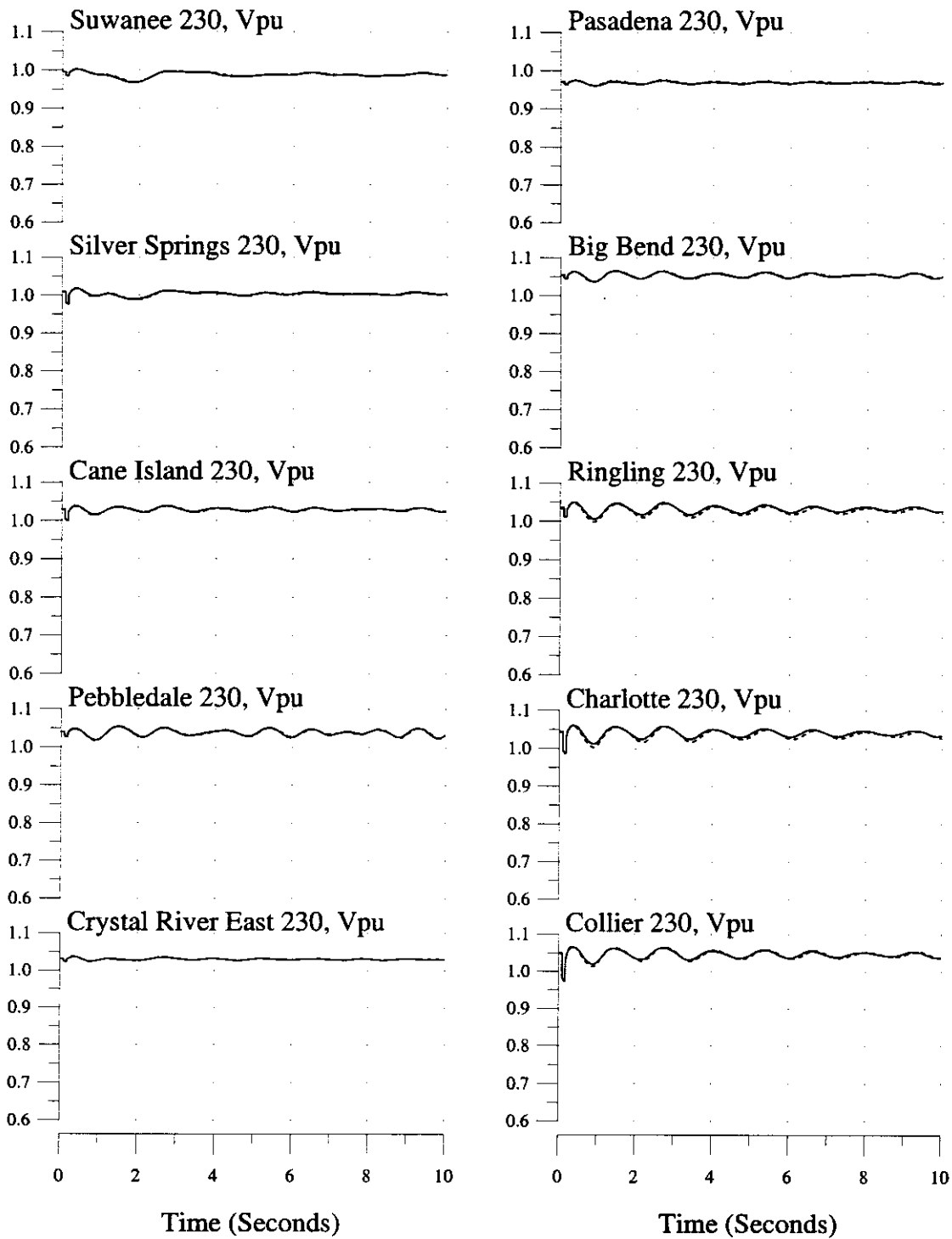

3-phase, 5-cycle Fault at Turkey Pt 230kV Bus, Trip Turkey Pt #3 & GSU
2003 Summer System

Machine & Interface Variables: (—) With Okeechobee TEC Dispatch, (...) Without

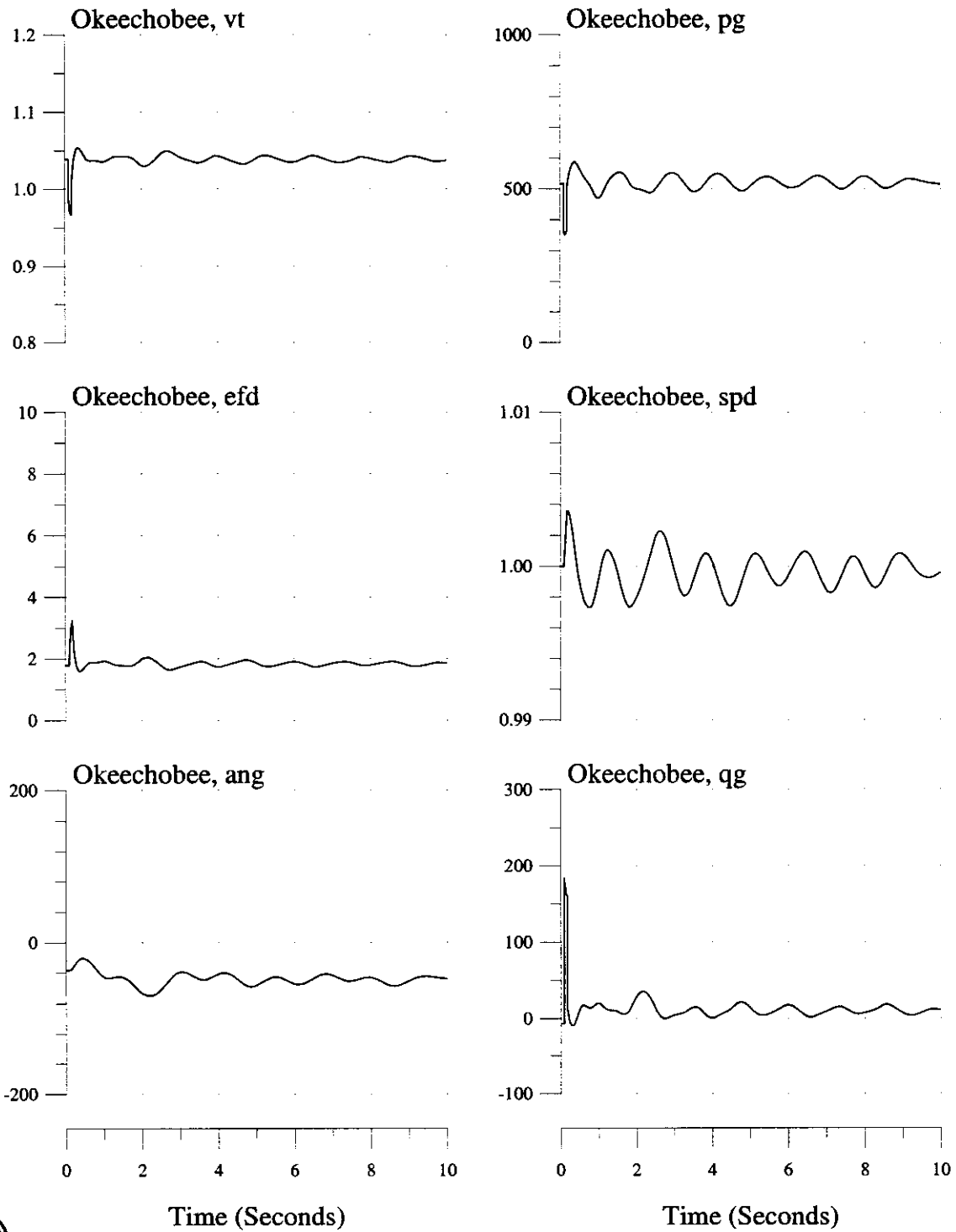

**3-phase, 5-cycle Fault at Turkey Pt 230kV Bus, Trip Turkey Pt #3 & GSU
2003 Summer System**

Machine & Interface Variables: (—) With Okeechobee TEC Dispatch, (...) Without

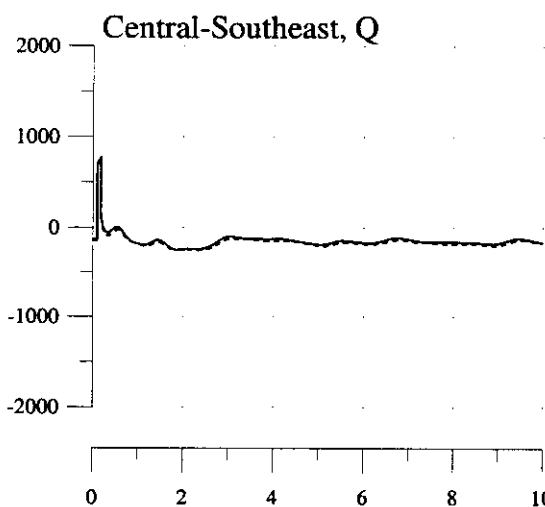
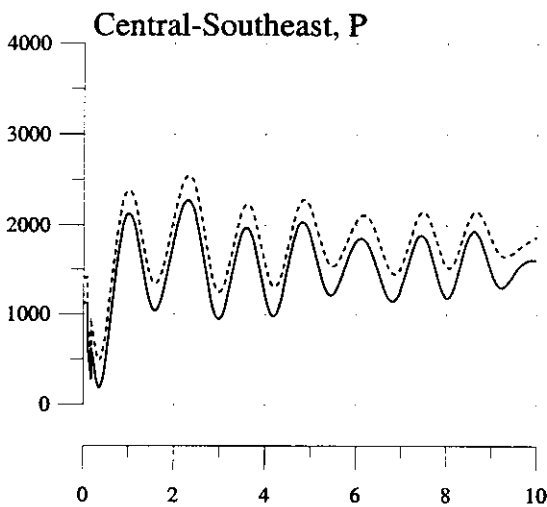
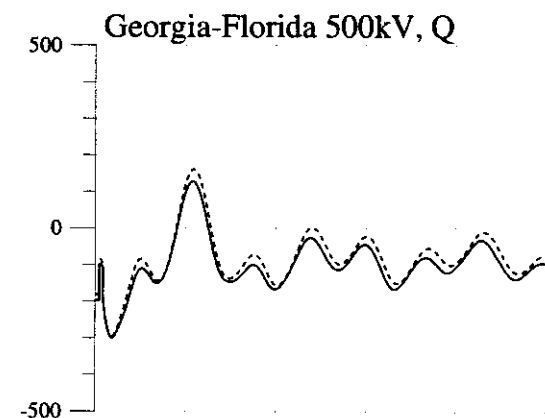
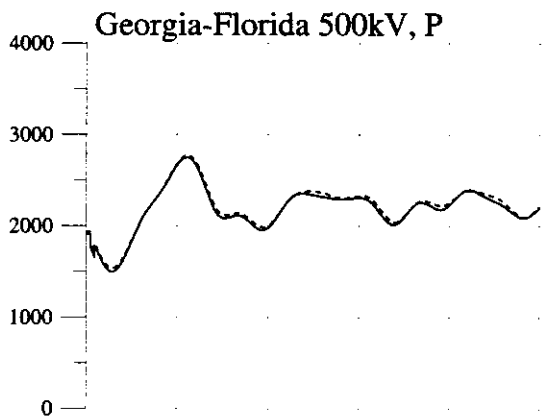
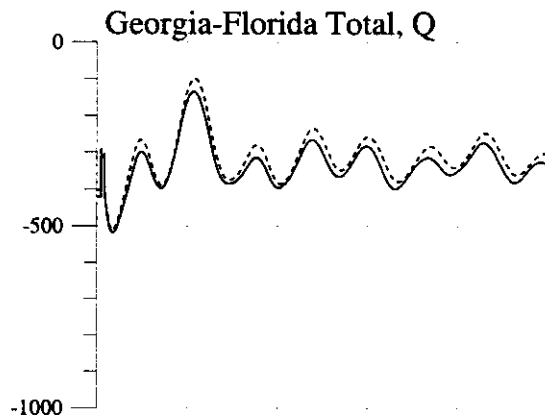
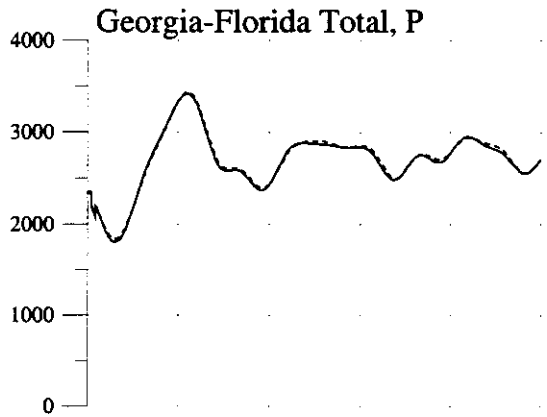

Time (Seconds)

Time (Seconds)



3-phase, 5-cycle Fault at Turkey Pt 230kV Bus, Trip Turkey Pt #3 & GSU
2003 Summer System

Machine Variables: (—) With Okeechobee TEC Dispatch, (...) Without

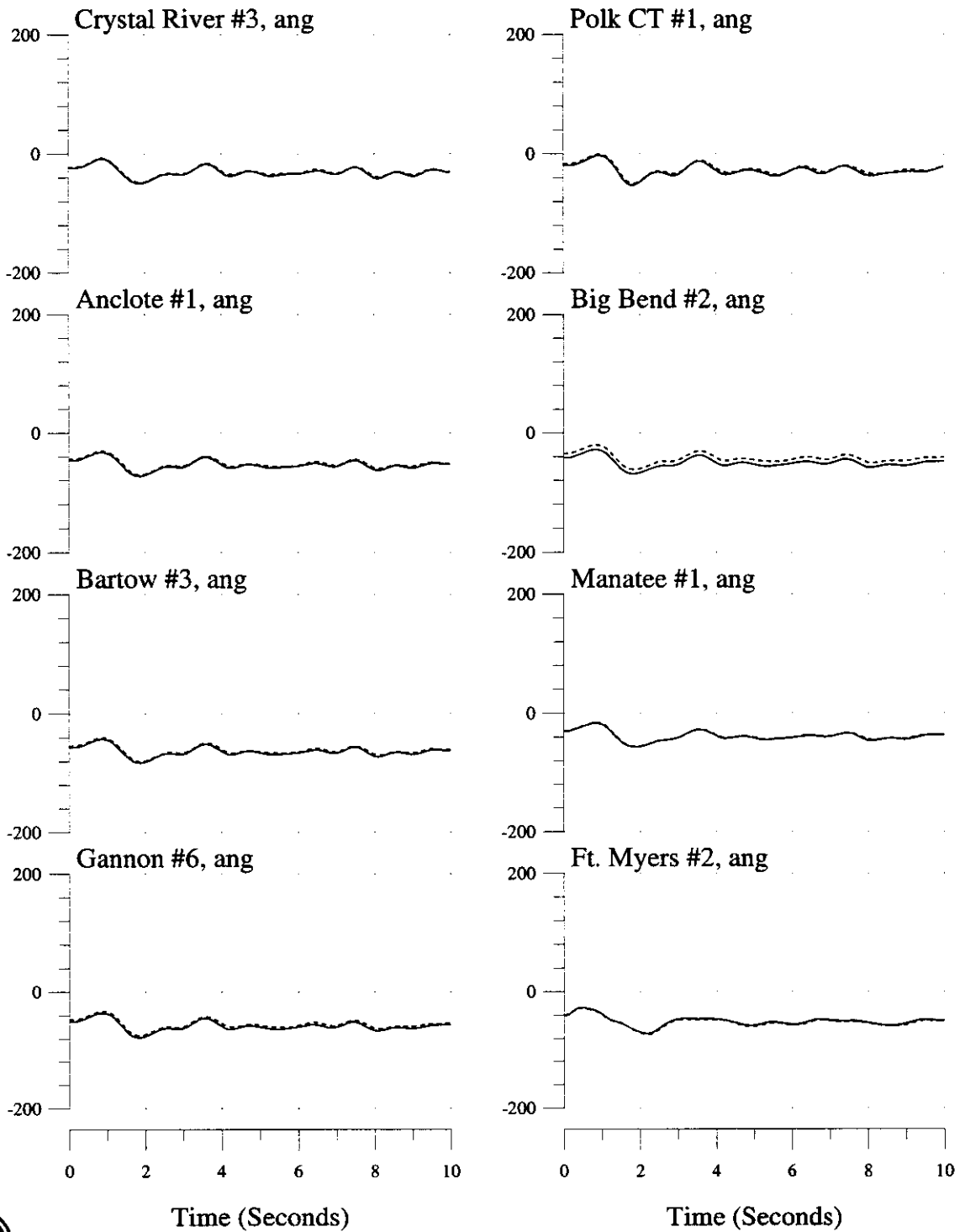

3-phase, 5-cycle Fault at Turkey Pt 230kV Bus, Trip Turkey Pt #3 & GSU
 2003 Summer System

Machine Variables: (—) With Okeechobee TEC Dispatch, (...) Without

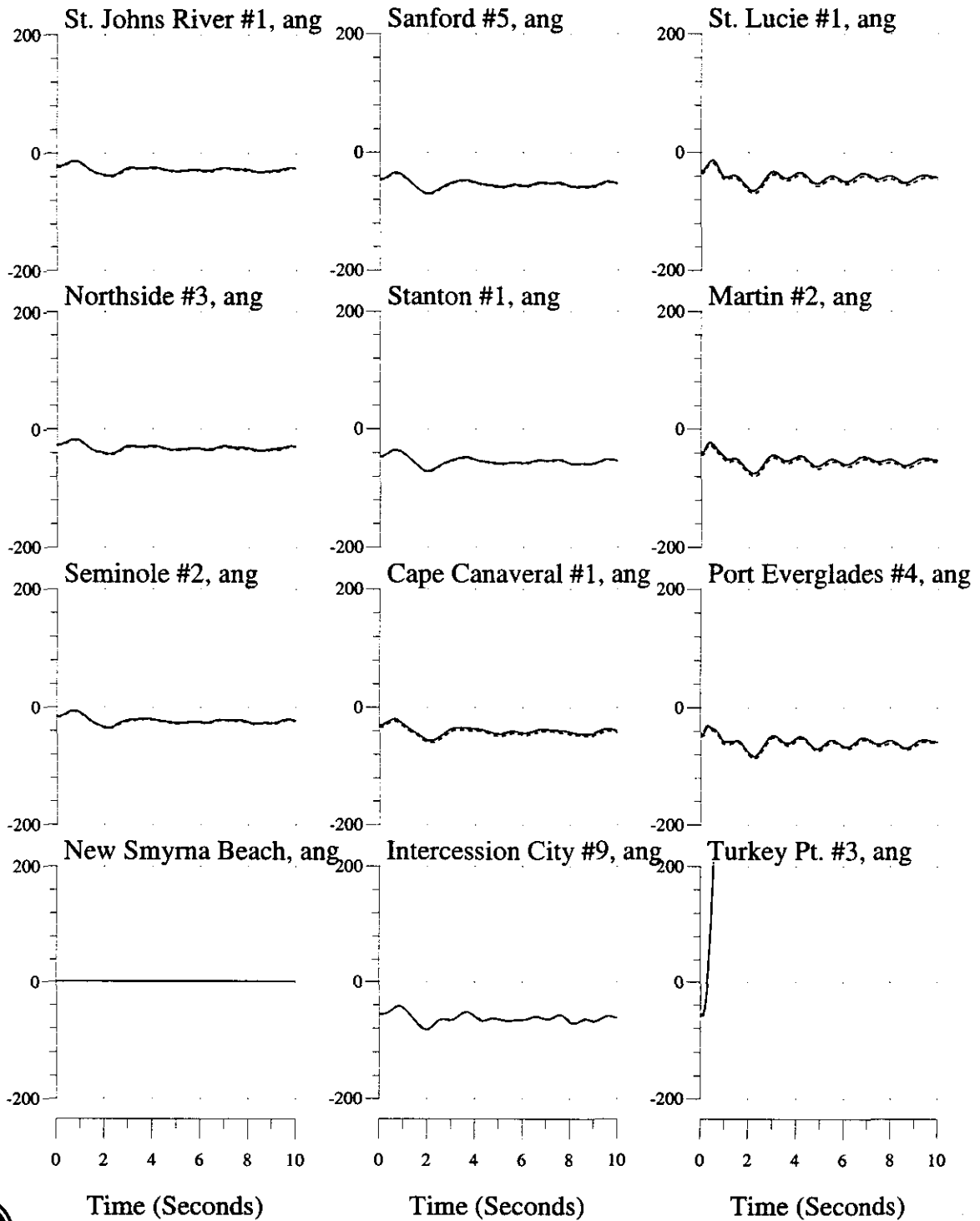

3-phase, 5-cycle Fault at Turkey Pt 230kV Bus, Trip Turkey Pt #3 & GSU
2003 Summer System

Bus Variables: (—) With Okeechobee TEC Dispatch, (...) Without

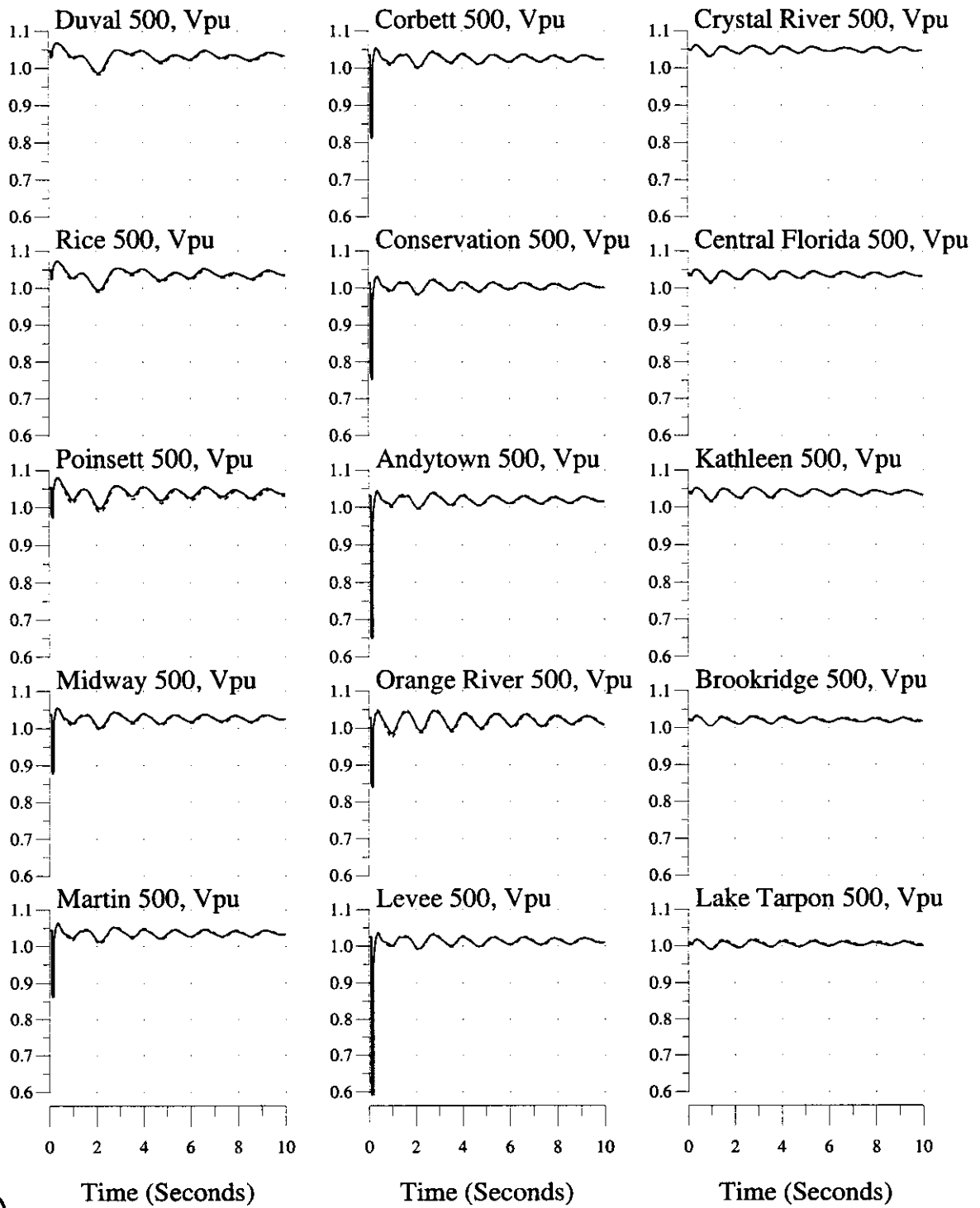

3-phase, 5-cycle Fault at Turkey Pt 230kV Bus, Trip Turkey Pt #3 & GSU
2003 Summer System

Bus Variables: (—) With Okeechobee TEC Dispatch, (...) Without

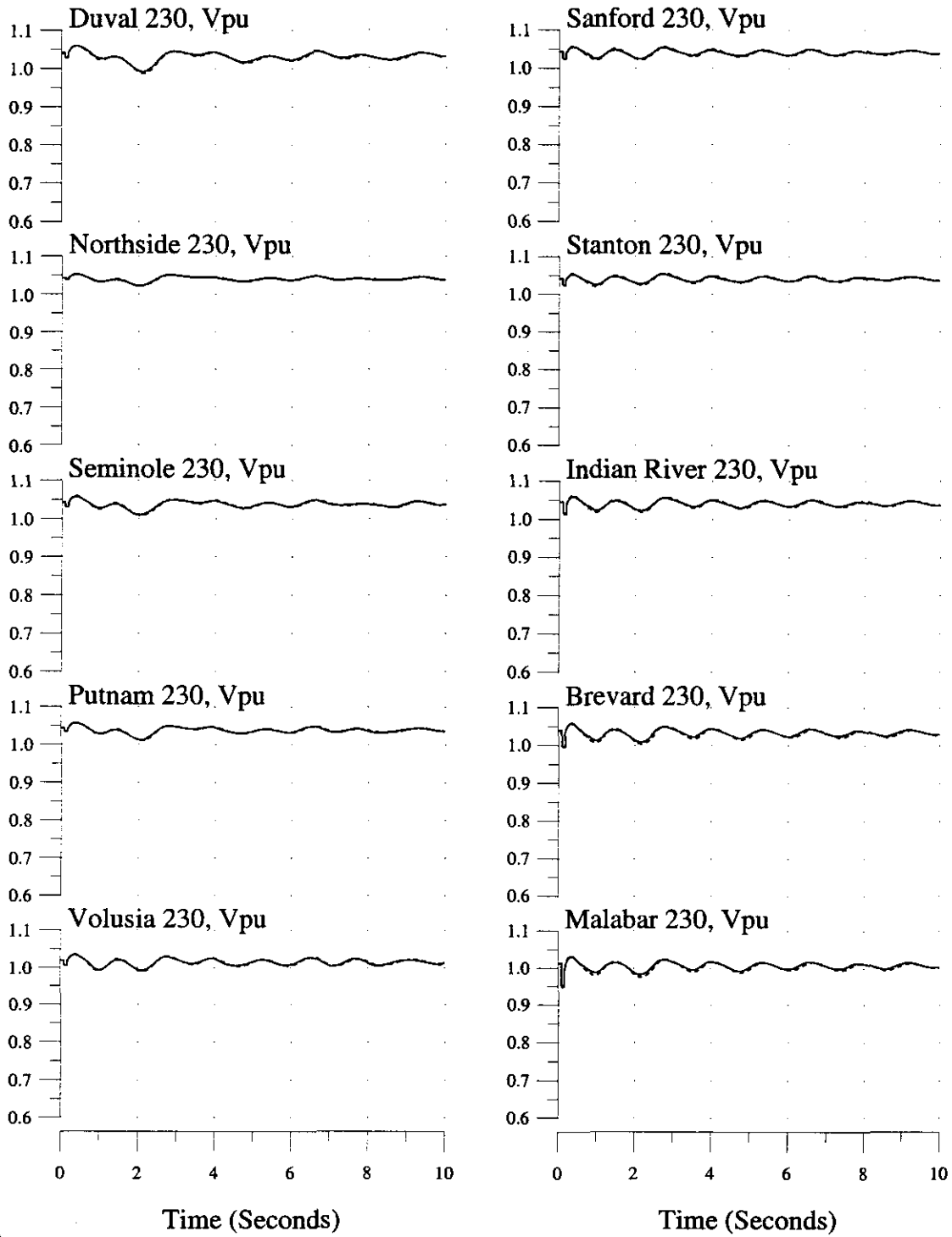

3-phase, 5-cycle Fault at Turkey Pt 230kV Bus, Trip Turkey Pt #3 & GSU
2003 Summer System

Bus Variables: (—) With Okeechobee TEC Dispatch, (...) Without

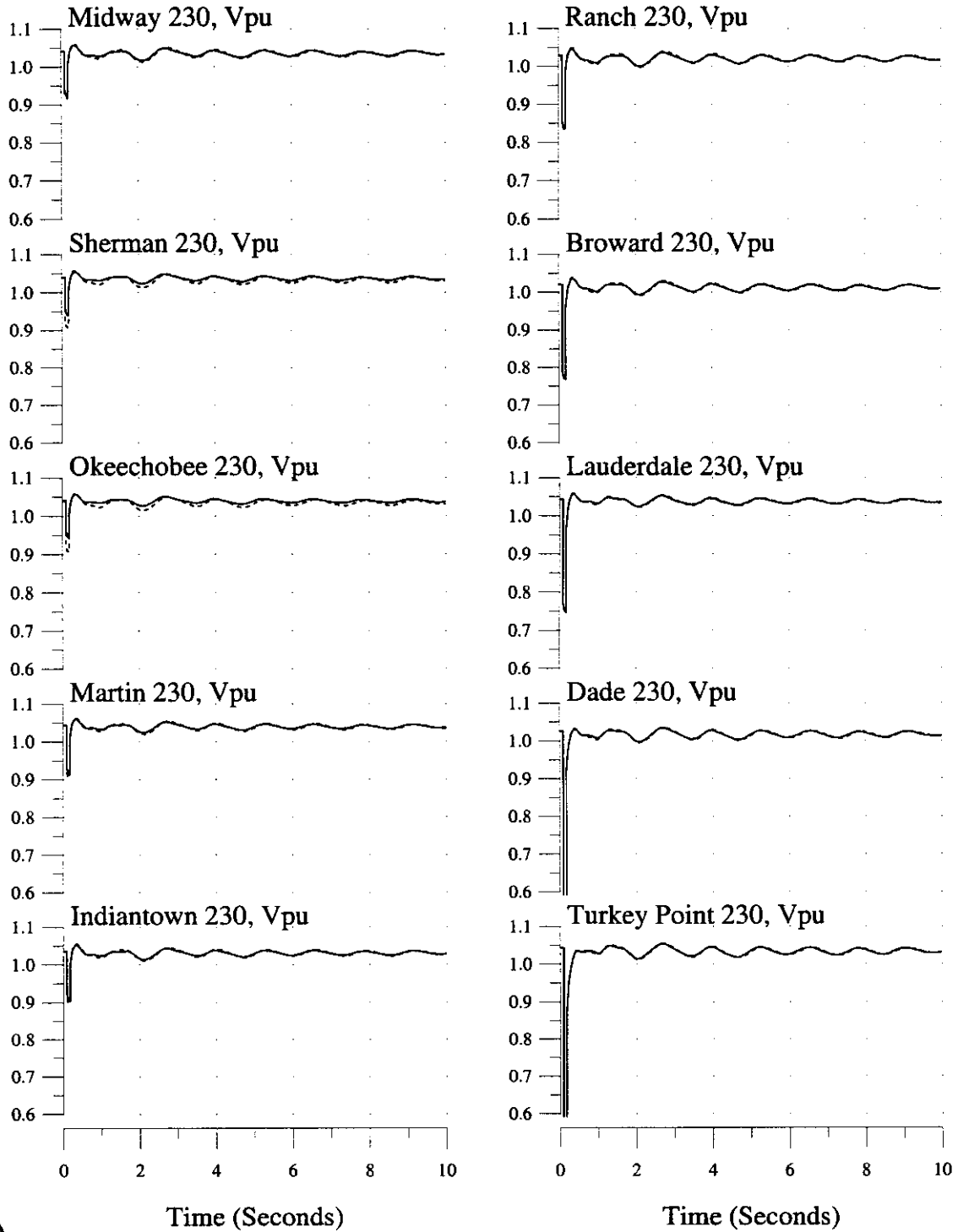

3-phase, 5-cycle Fault at Turkey Pt 230kV Bus, Trip Turkey Pt #3 & GSU
 2003 Summer System

Bus Variables: (—) With Okeechobee TEC Dispatch, (...) Without

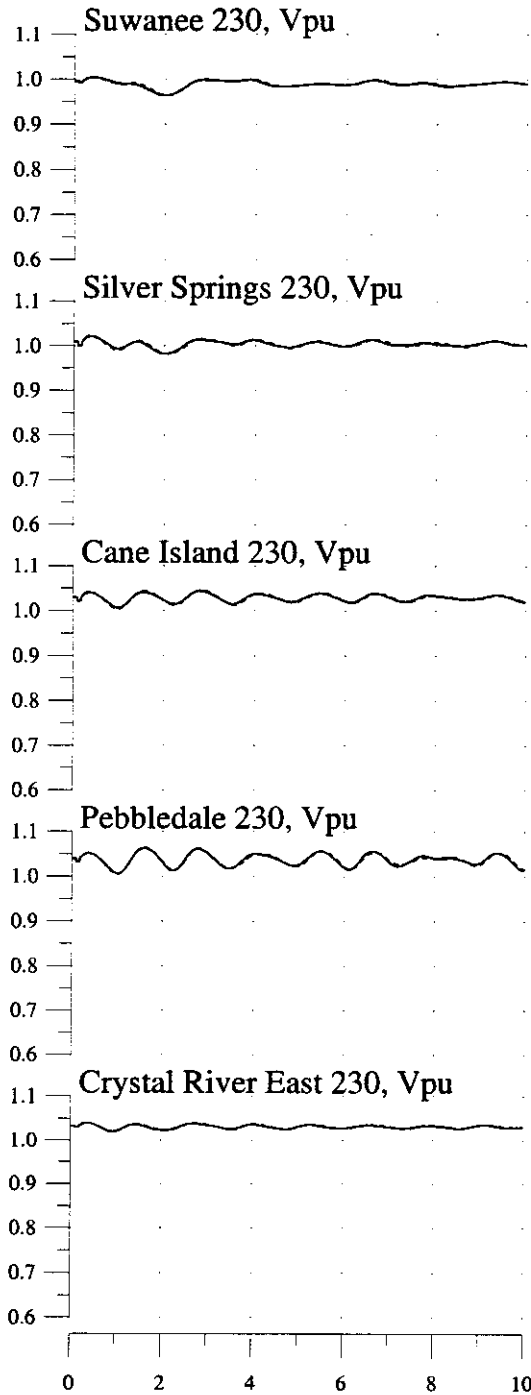

Time (Seconds)

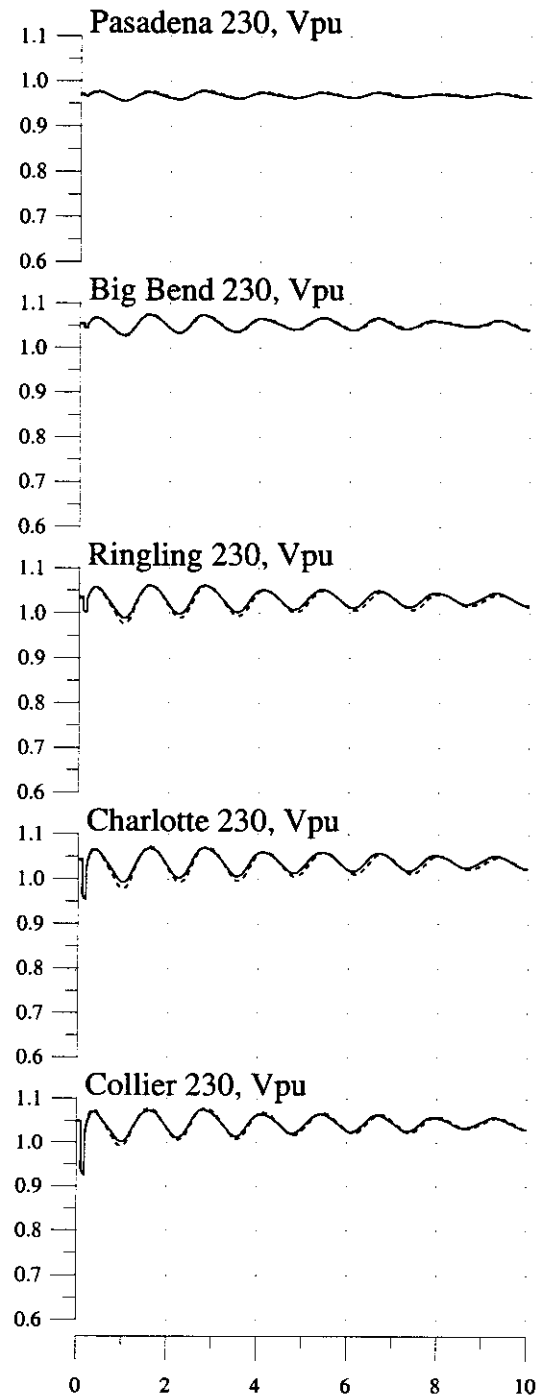

Time (Seconds)



3-phase, 5-cycle Fault at Seminole 230kV Bus, Trip Seminole #1 & GSU
2003 Summer System

Machine & Interface Variables: (—) With Okeechobee TEC Dispatch, (...) Without

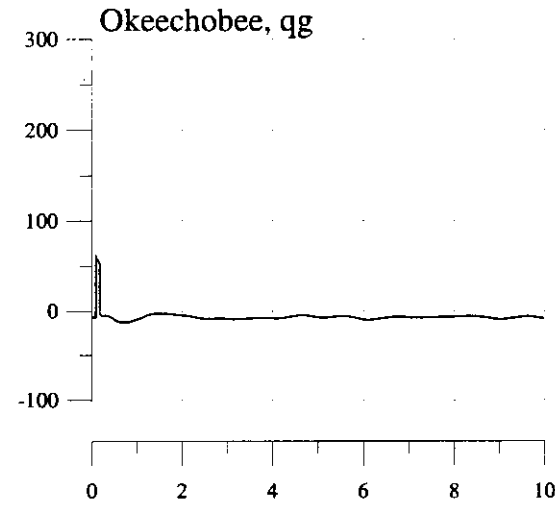
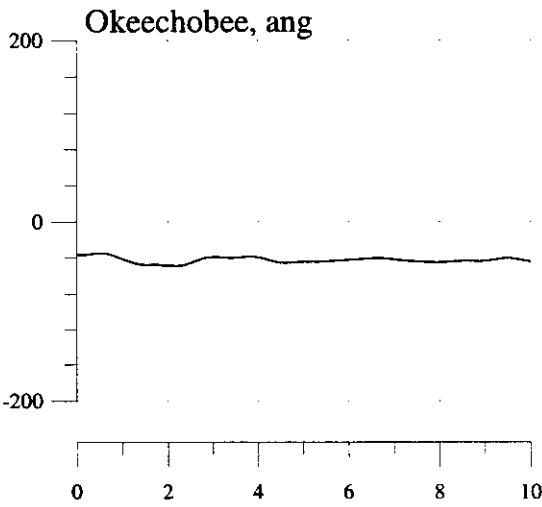
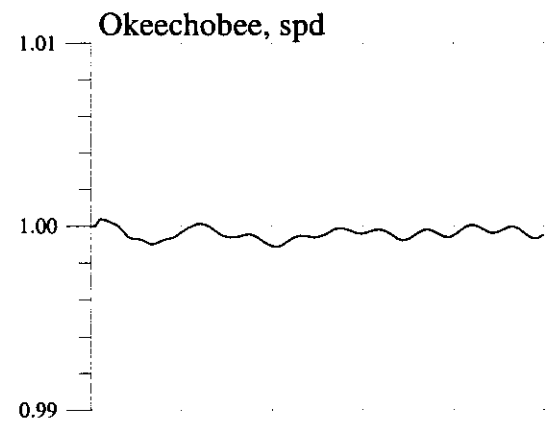
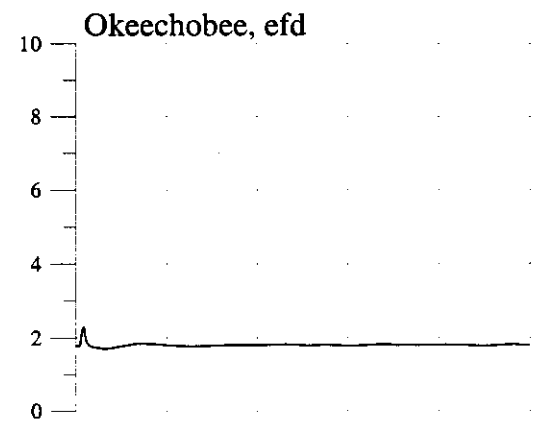
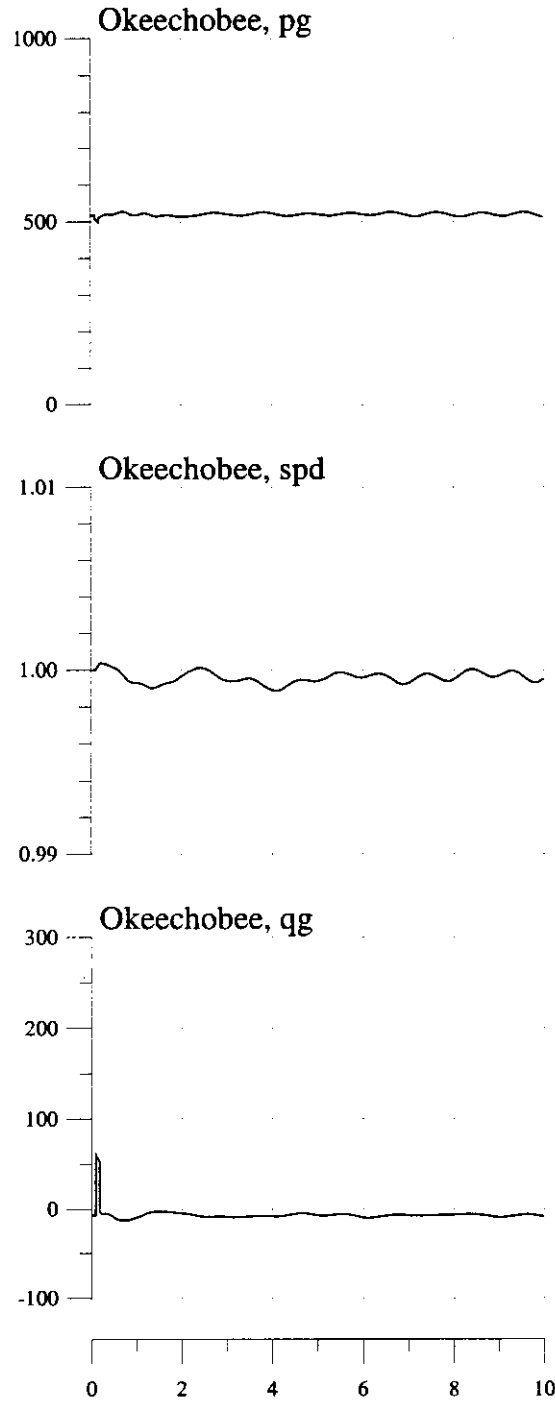
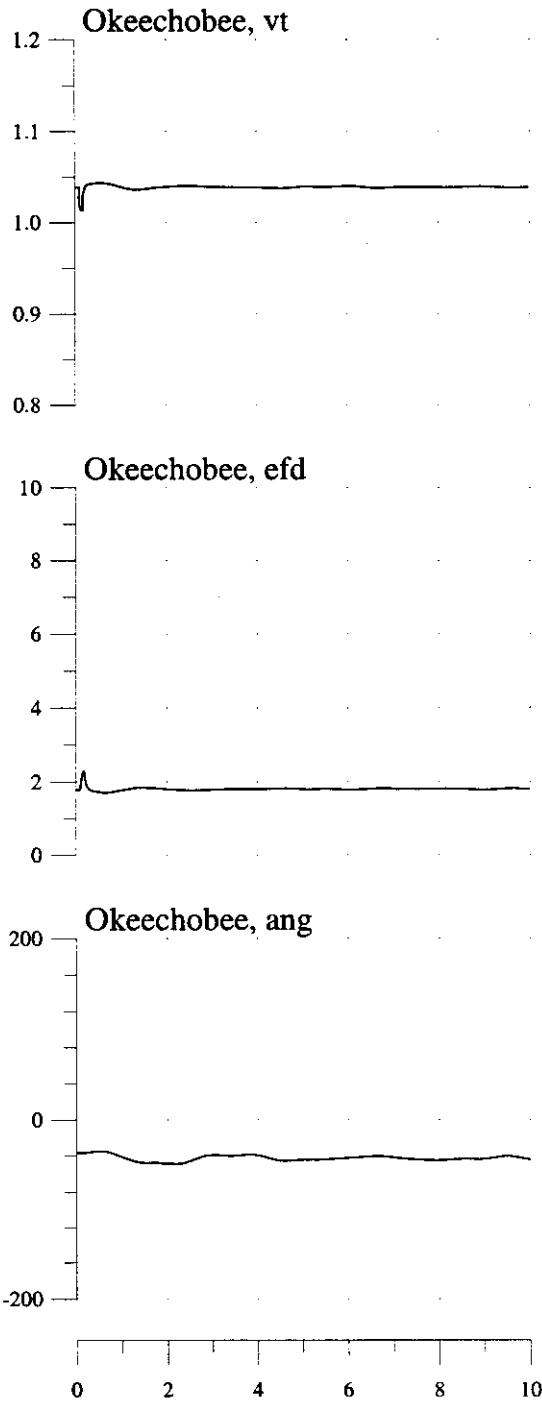

3-phase, 5-cycle Fault at Seminole 230kV Bus, Trip Seminole #1 & GSU
2003 Summer System

Machine & Interface Variables: (—) With Okeechobee TEC Dispatch, (...) Without

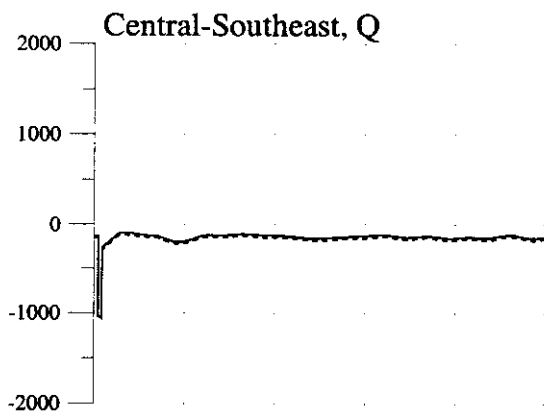
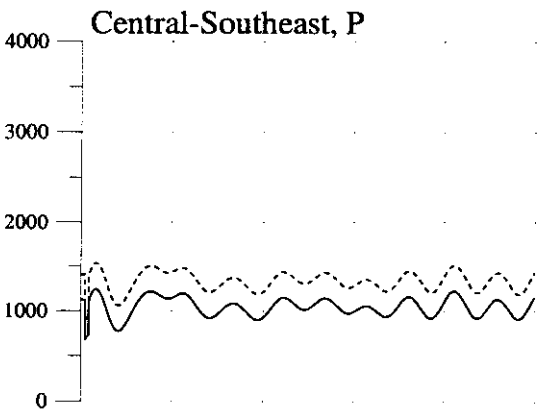
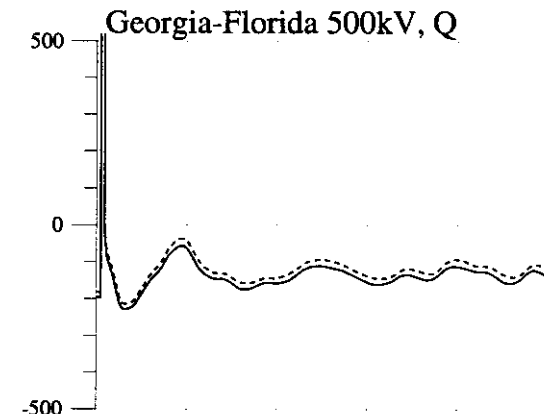
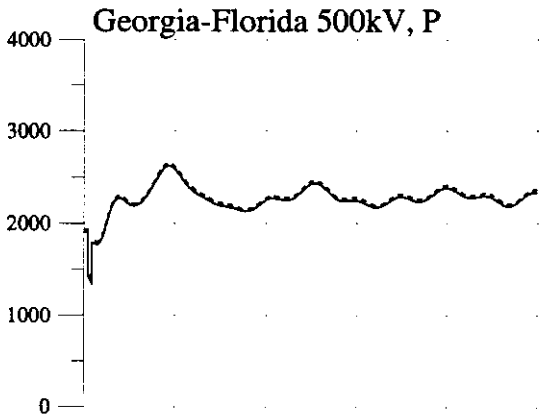
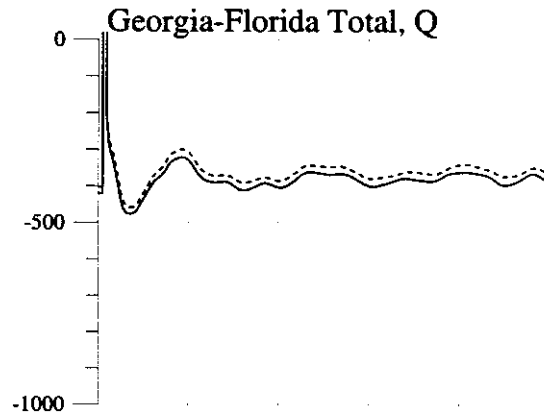
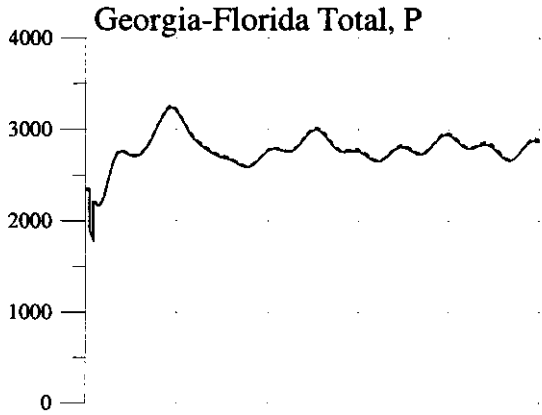

Time (Seconds)

Time (Seconds)



3-phase, 5-cycle Fault at Seminole 230kV Bus, Trip Seminole #1 & GSU
2003 Summer System

Machine Variables: (—) With Okeechobee TEC Dispatch, (...) Without

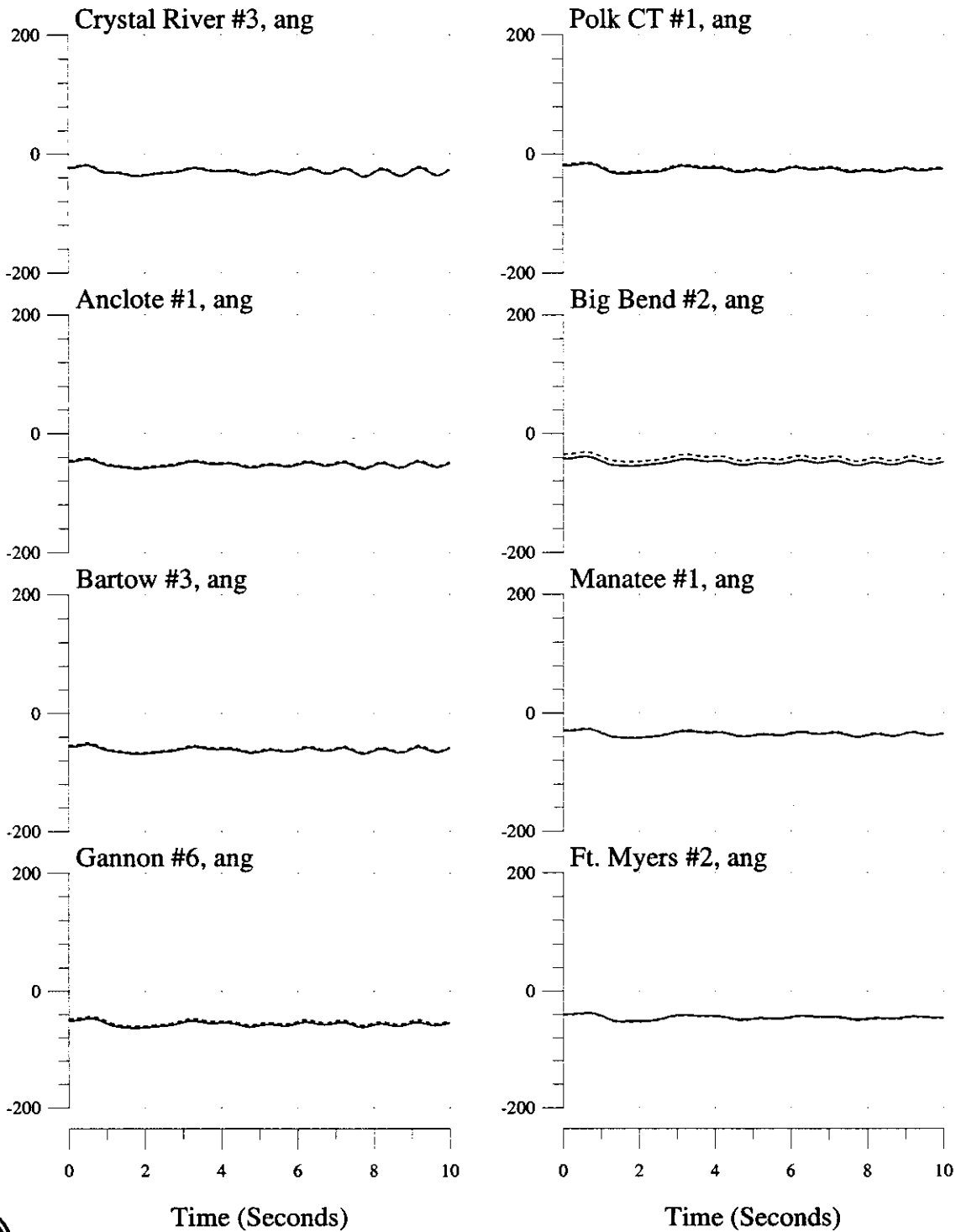

3-phase, 5-cycle Fault at Seminole 230kV Bus, Trip Seminole #1 & GSU
 2003 Summer System

Machine Variables: (—) With Okeechobee TEC Dispatch, (...) Without

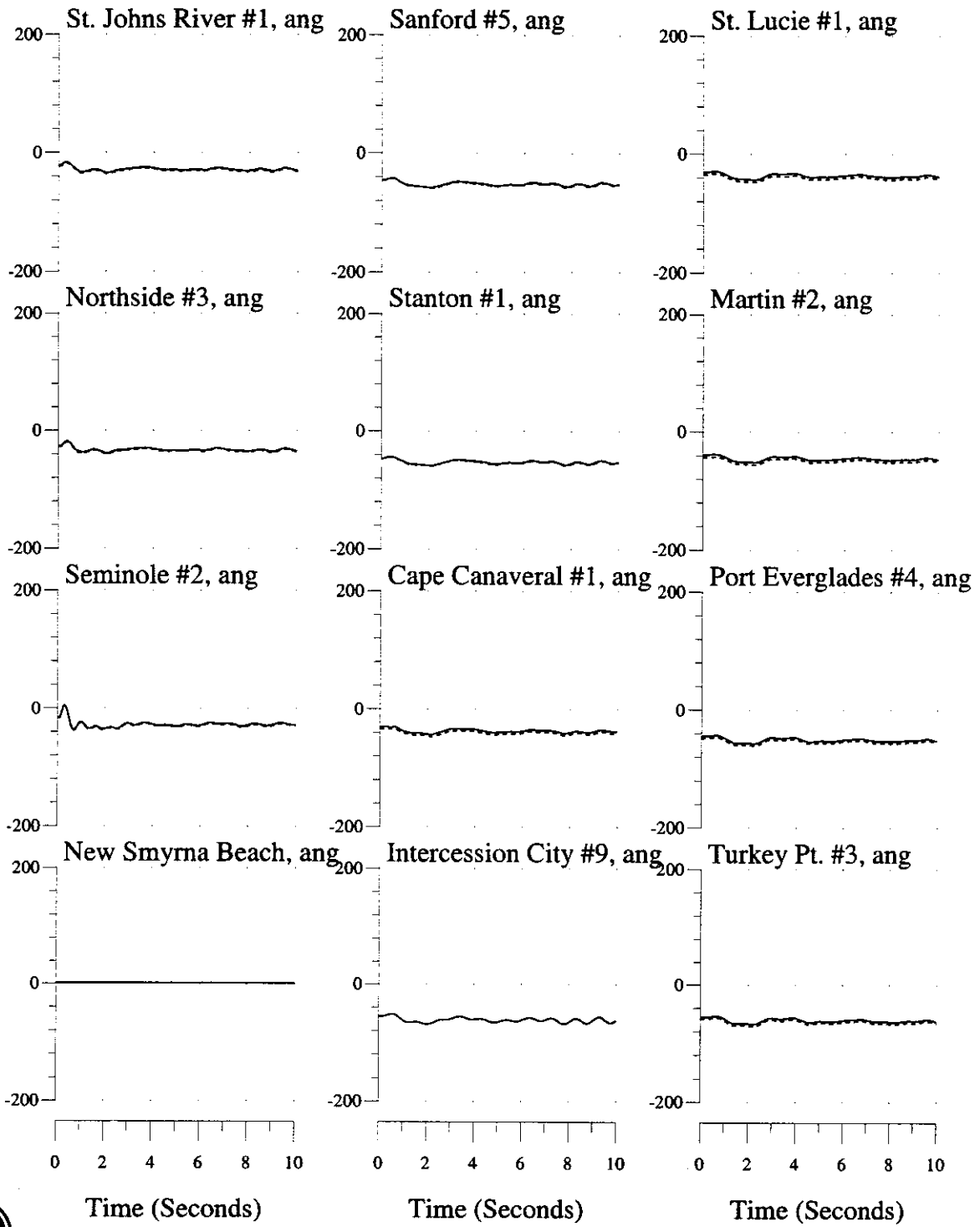

3-phase, 5-cycle Fault at Seminole 230kV Bus, Trip Seminole #1 & GSU
 2003 Summer System

Bus Variables: (___) With Okeechobee TEC Dispatch, (...) Without

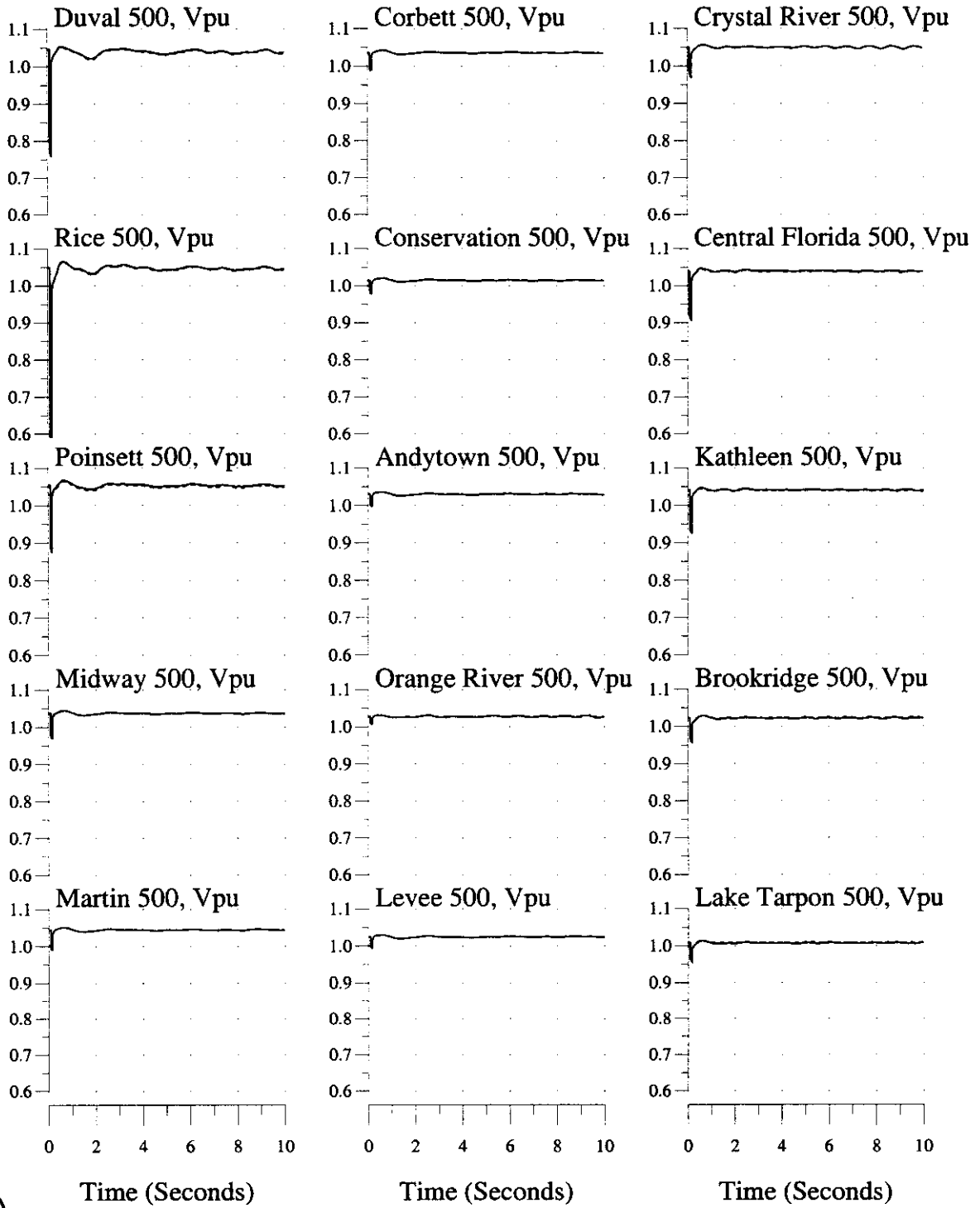

3-phase, 5-cycle Fault at Seminole 230kV Bus, Trip Seminole #1 & GSU
2003 Summer System

Bus Variables: (___) With Okeechobee TEC Dispatch, (...) Without

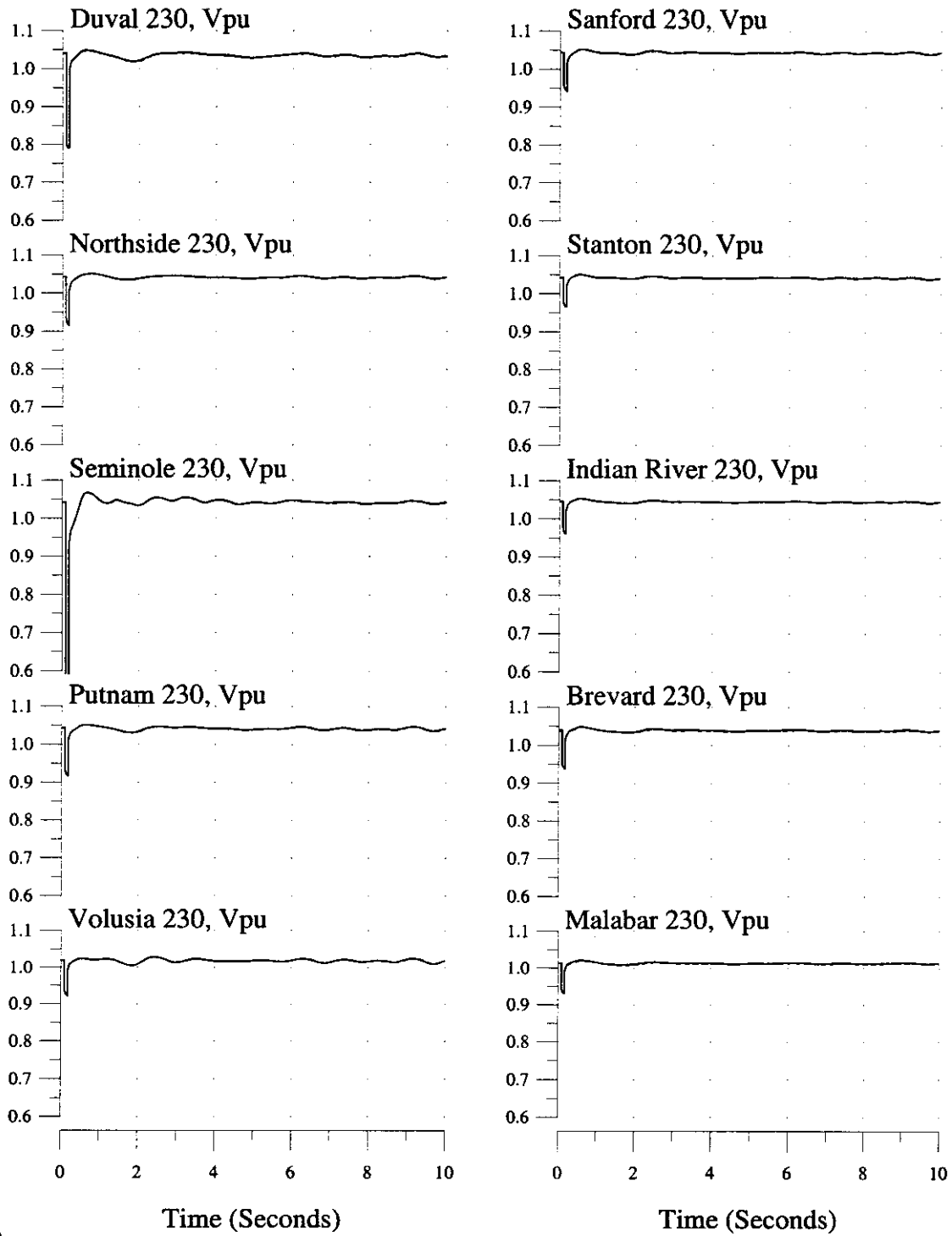

3-phase, 5-cycle Fault at Seminole 230kV Bus, Trip Seminole #1 & GSU
2003 Summer System

Bus Variables: (___) With Okeechobee TEC Dispatch, (...) Without

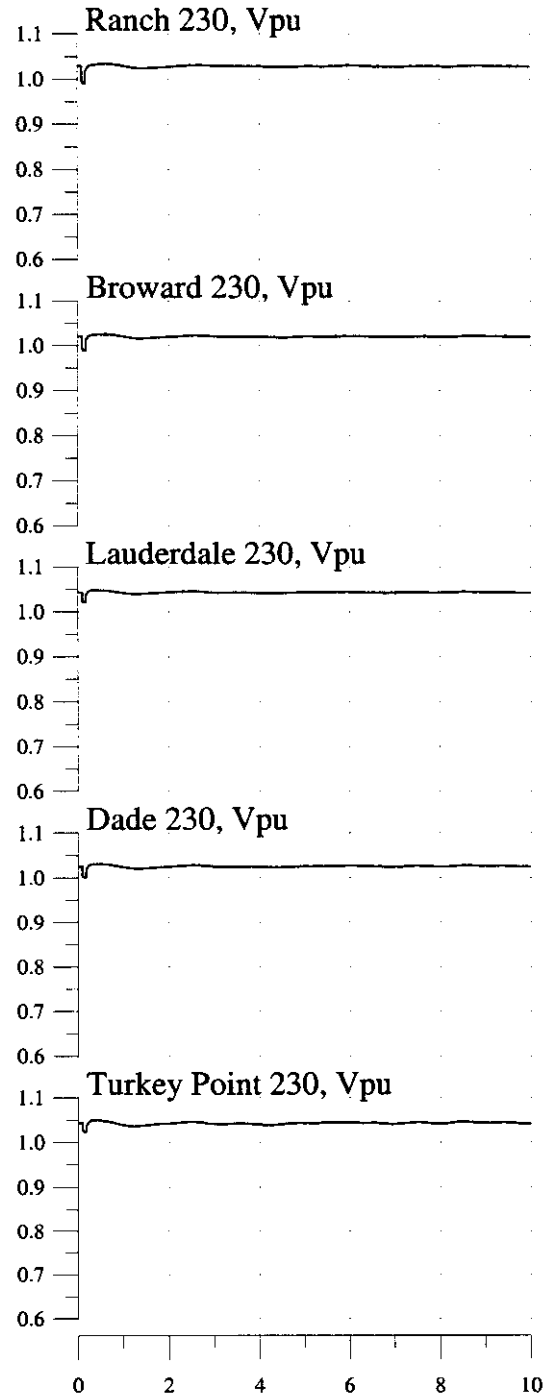
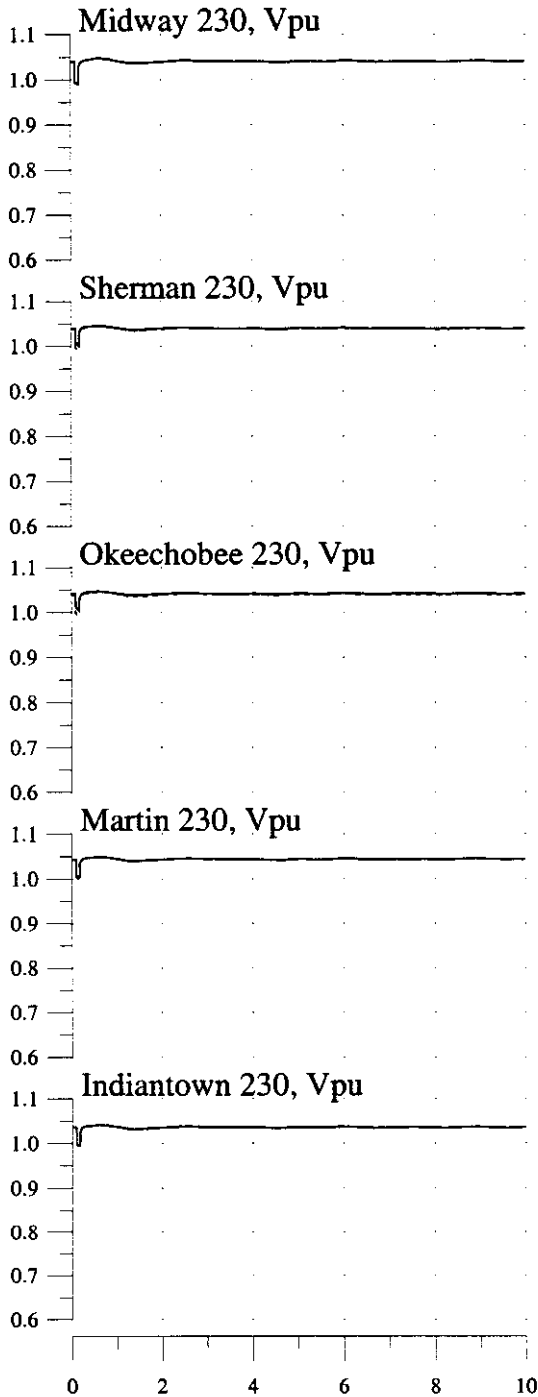

3-phase, 5-cycle Fault at Seminole 230kV Bus, Trip Seminole #1 & GSU
 2003 Summer System

Bus Variables: (—) With Okeechobee TEC Dispatch, (...) Without

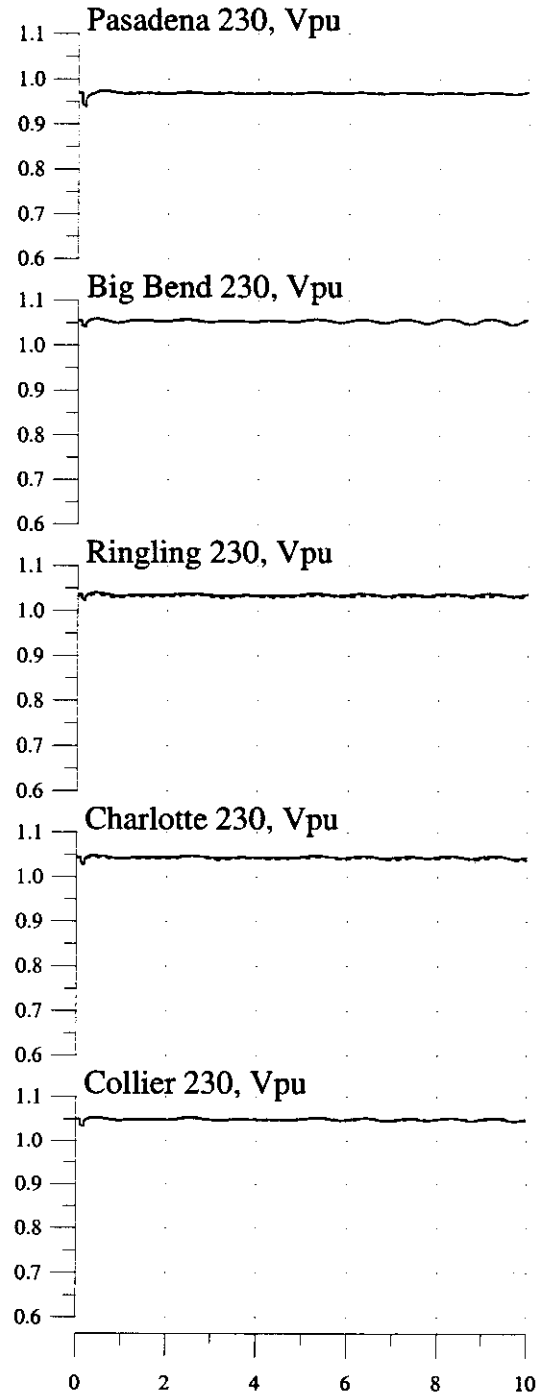
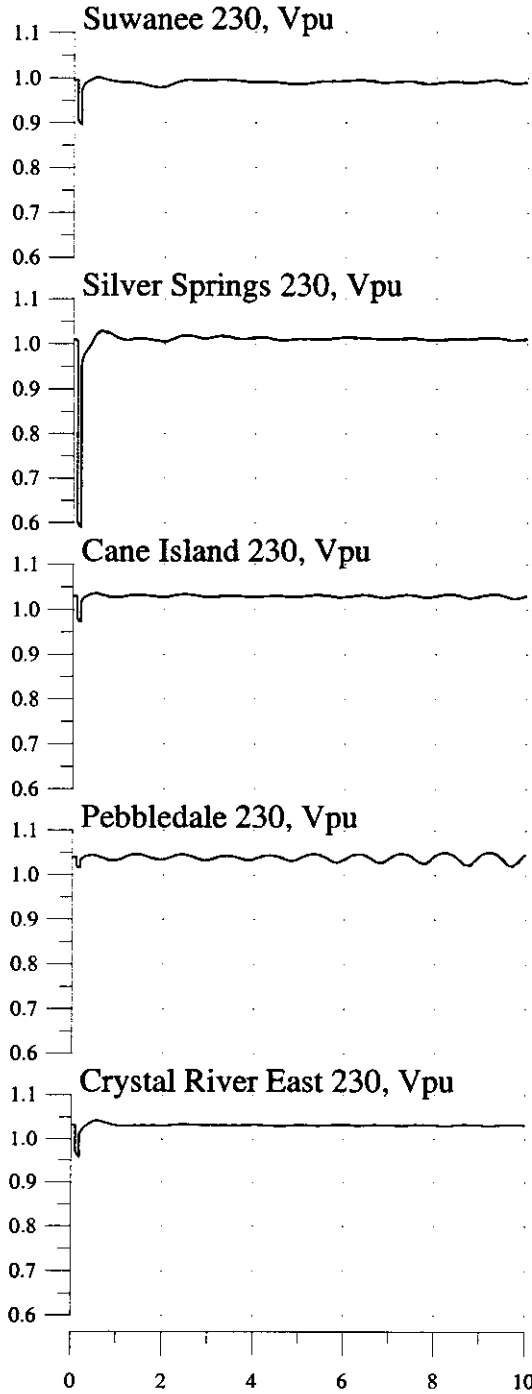

Time (Seconds)

Time (Seconds)



3-phase, 5-cycle Fault at Martin 500kV Bus, Trip Martin #2 & GSU
 2003 Summer System

Machine & Interface Variables: (—) With Okeechobee TEC Dispatch, (...) Without

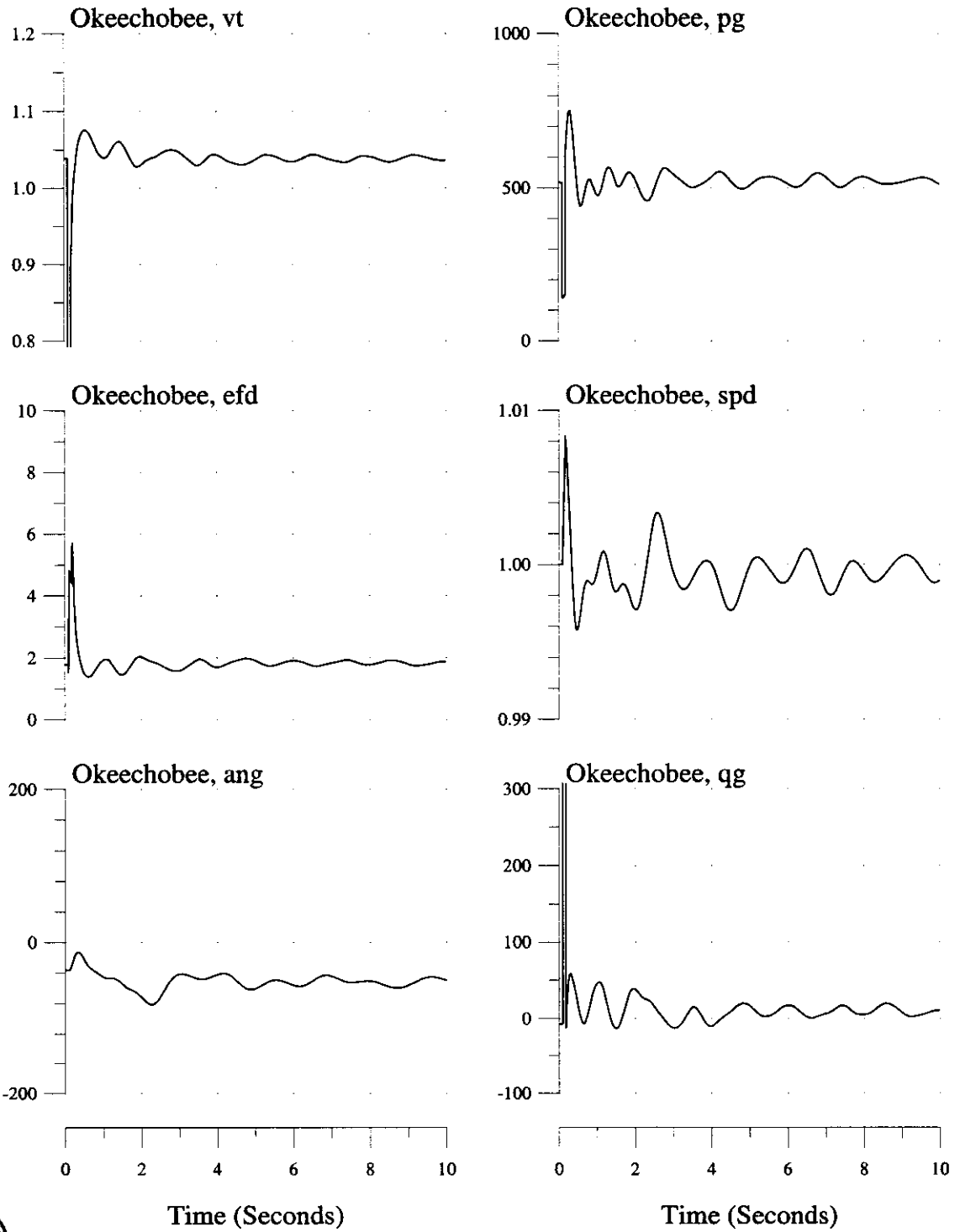

3-phase, 5-cycle Fault at Martin 500kV Bus, Trip Martin #2 & GSU
2003 Summer System

Machine & Interface Variables: (___) With Okeechobee TEC Dispatch, (...) Without

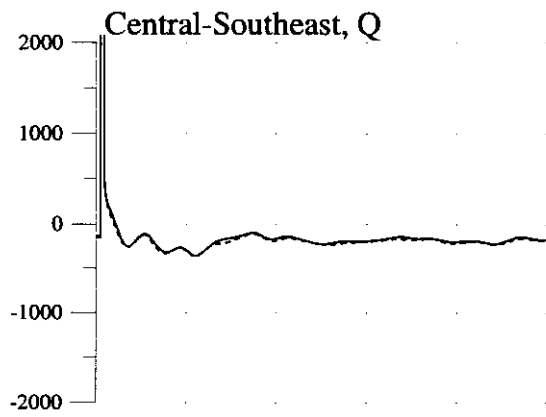
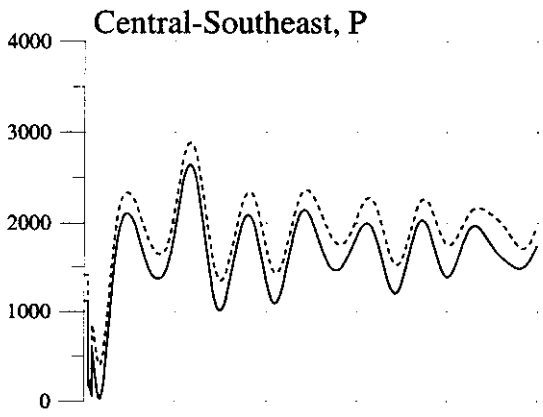
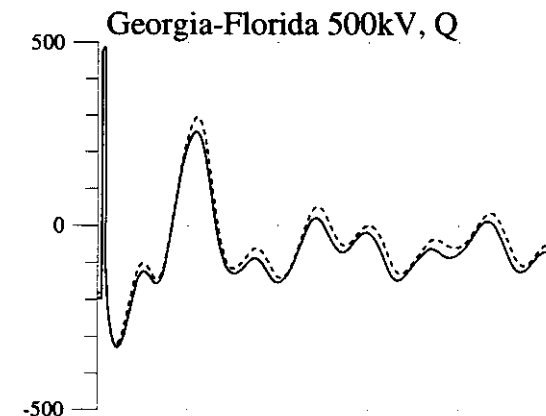
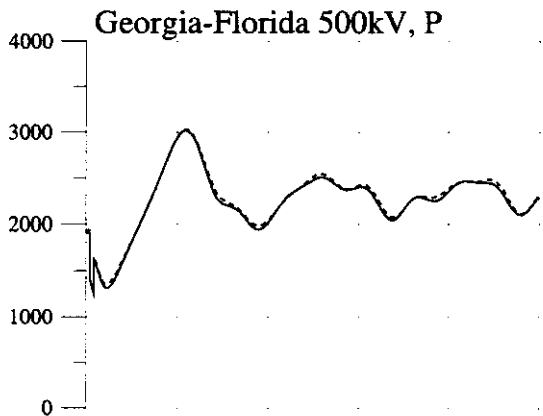
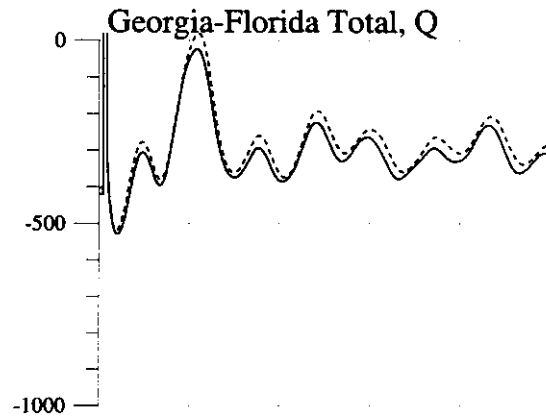
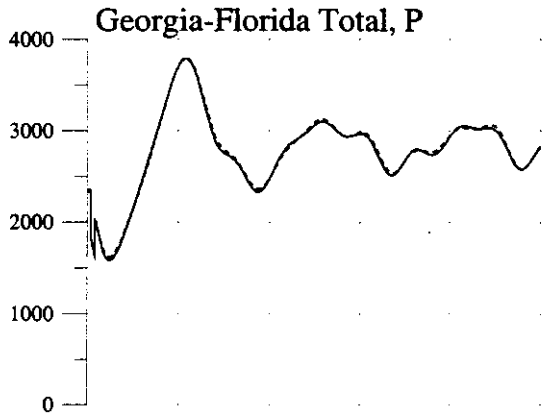

Time (Seconds)

Time (Seconds)



3-phase, 5-cycle Fault at Martin 500kV Bus, Trip Martin #2 & GSU
2003 Summer System

Machine Variables: (—) With Okeechobee TEC Dispatch, (...) Without

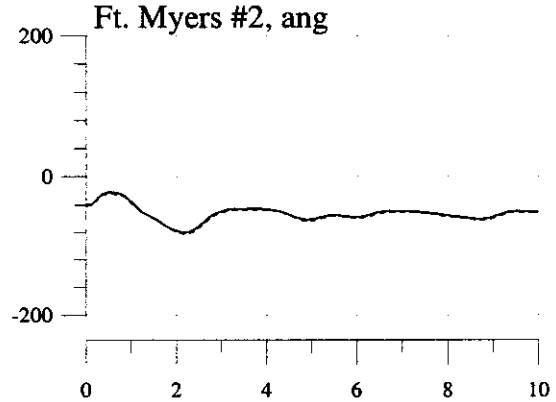
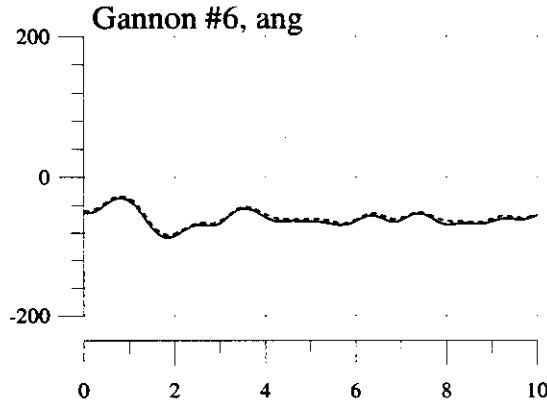
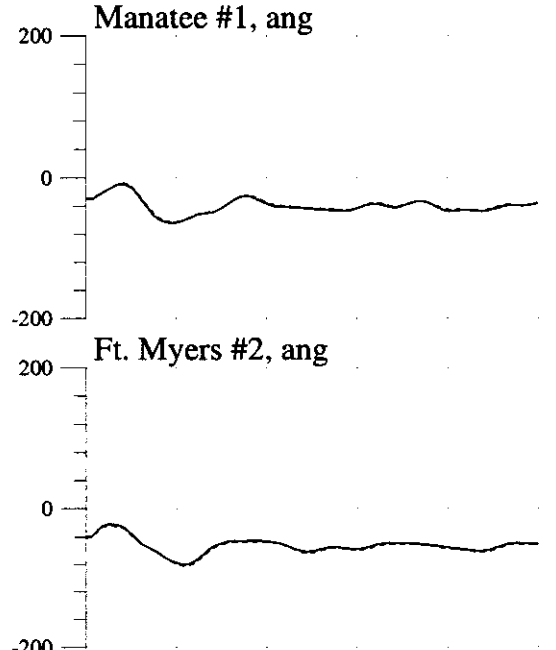
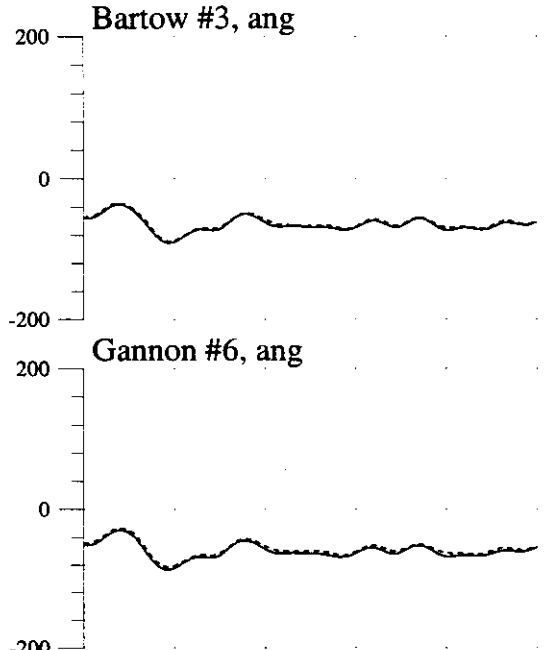
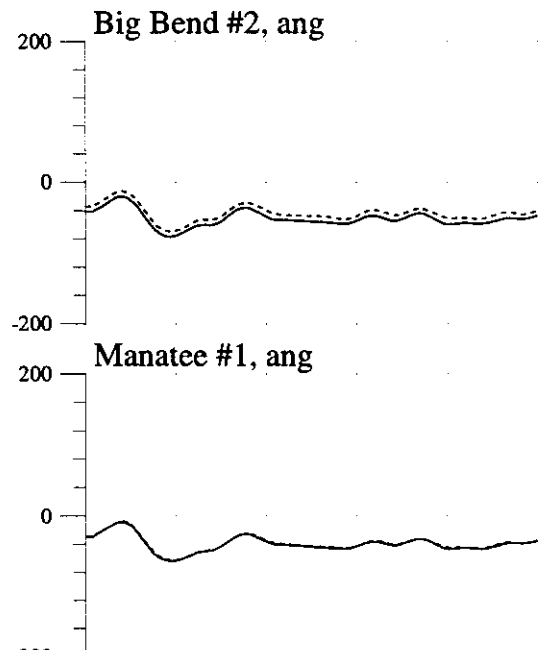
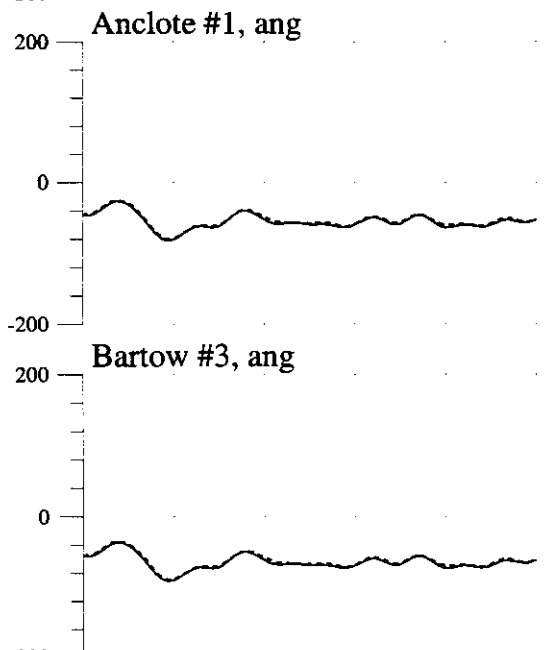
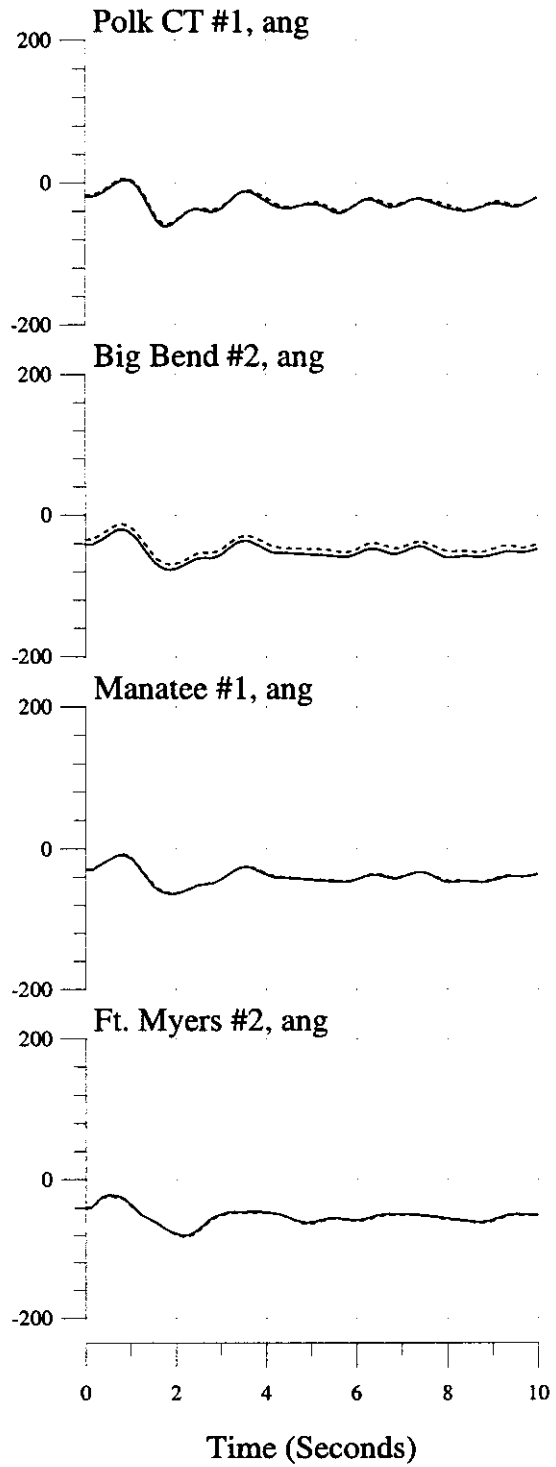
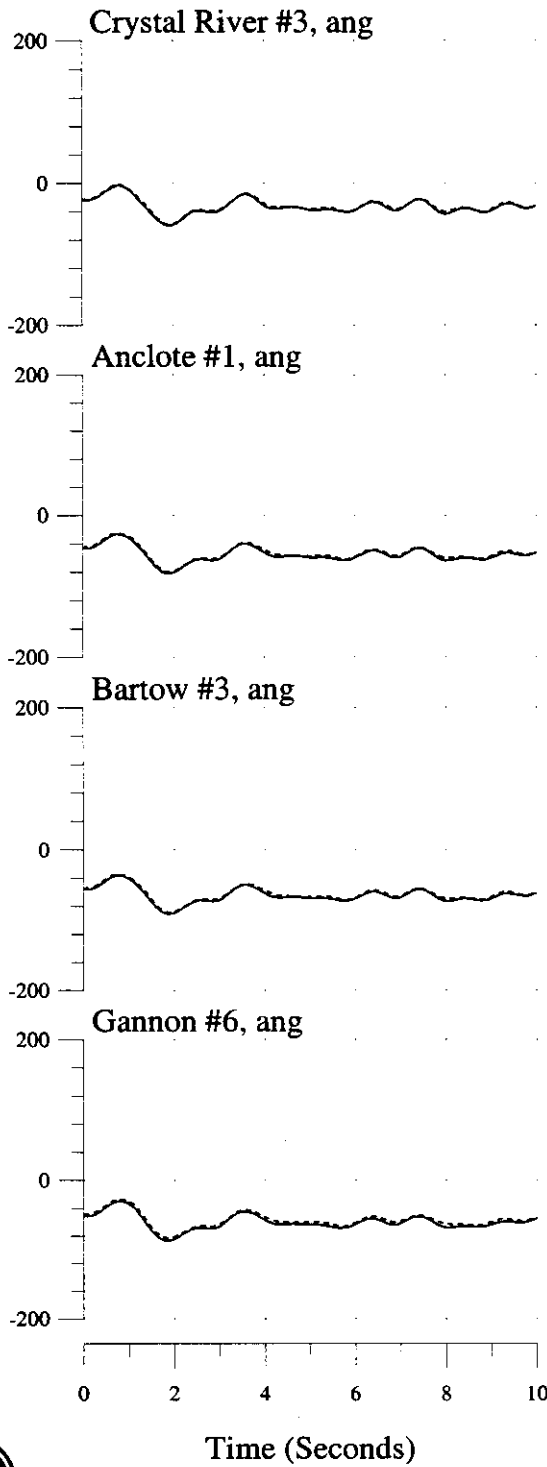

3-phase, 5-cycle Fault at Martin 500kV Bus, Trip Martin #2 & GSU
 2003 Summer System

Machine Variables: (___) With Okeechobee TEC Dispatch, (...) Without

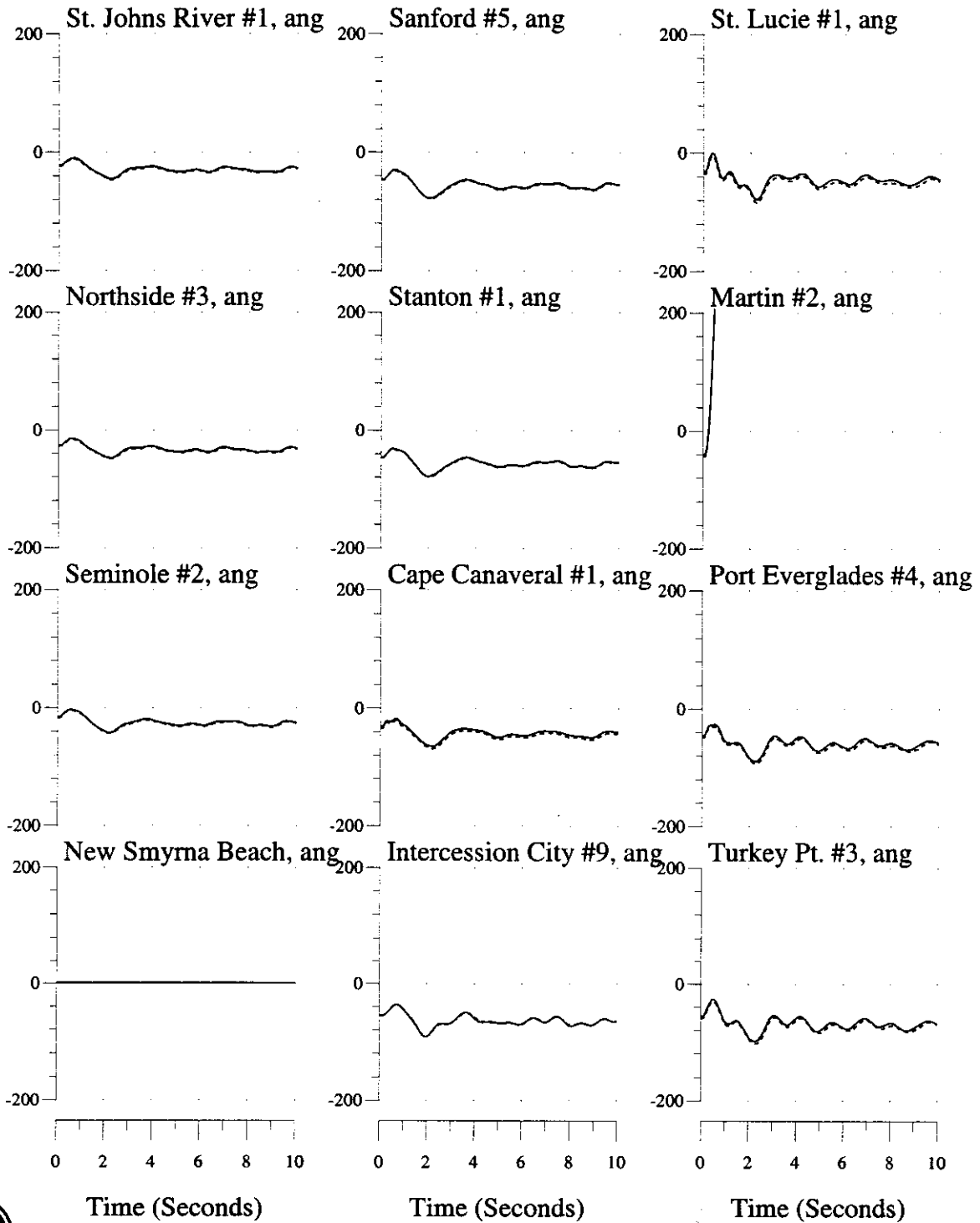

3-phase, 5-cycle Fault at Martin 500kV Bus, Trip Martin #2 & GSU
2003 Summer System

Bus Variables: (—) With Okeechobee TEC Dispatch, (...) Without

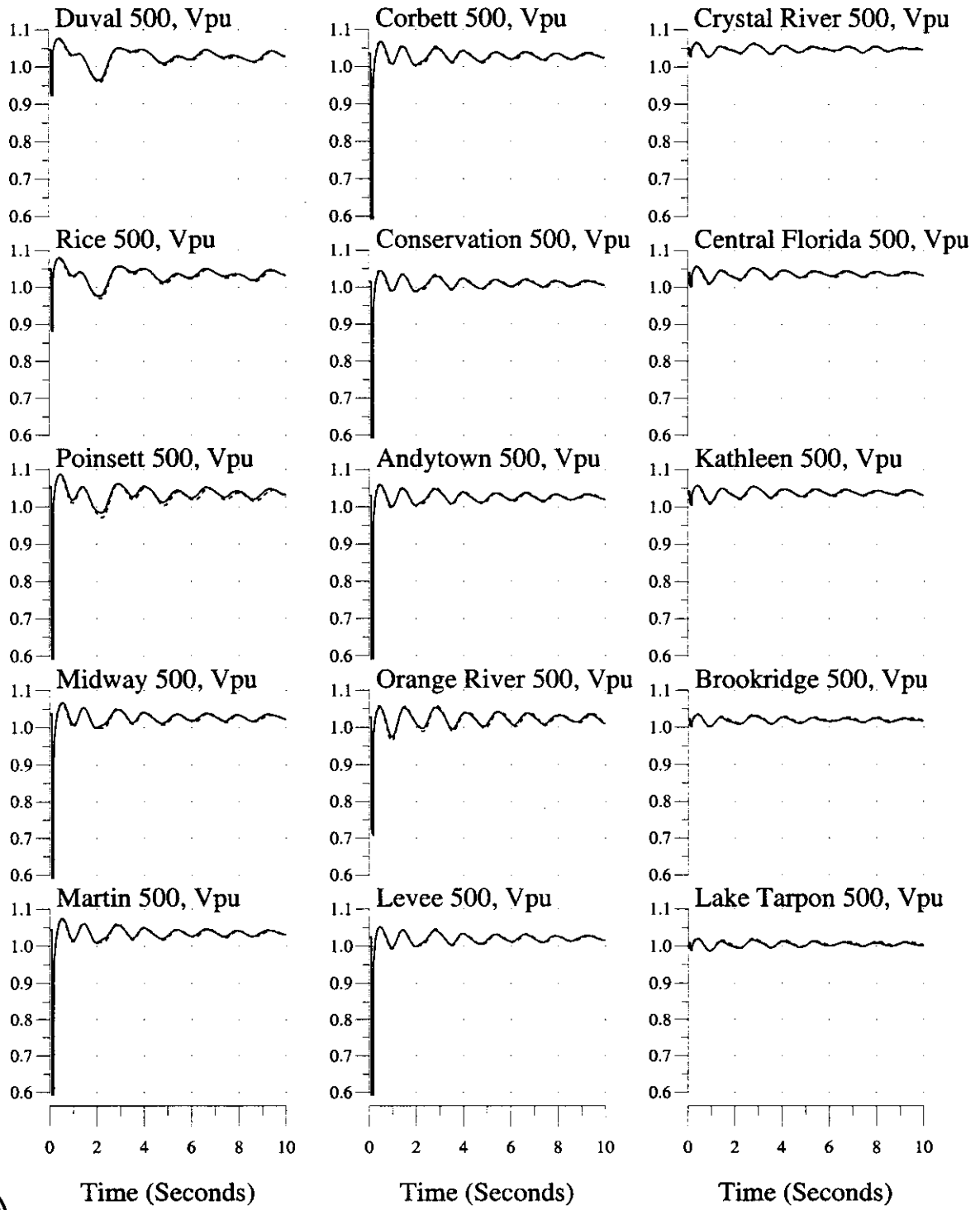

3-phase, 5-cycle Fault at Martin 500kV Bus, Trip Martin #2 & GSU
2003 Summer System

Bus Variables: (—) With Okeechobee TEC Dispatch, (...) Without

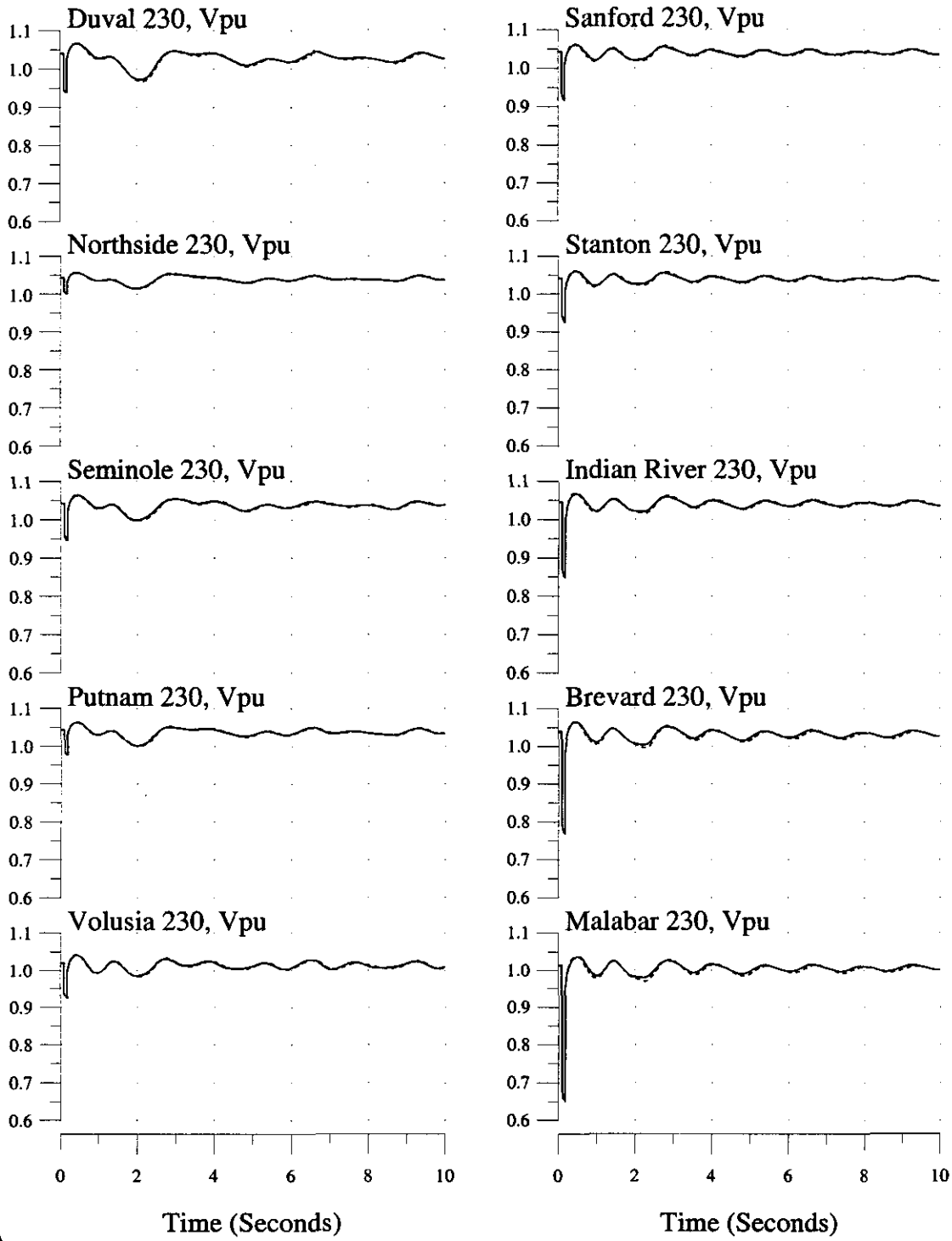

3-phase, 5-cycle Fault at Martin 500kV Bus, Trip Martin #2 & GSU
2003 Summer System

Bus Variables: (—) With Okeechobee TEC Dispatch, (...) Without

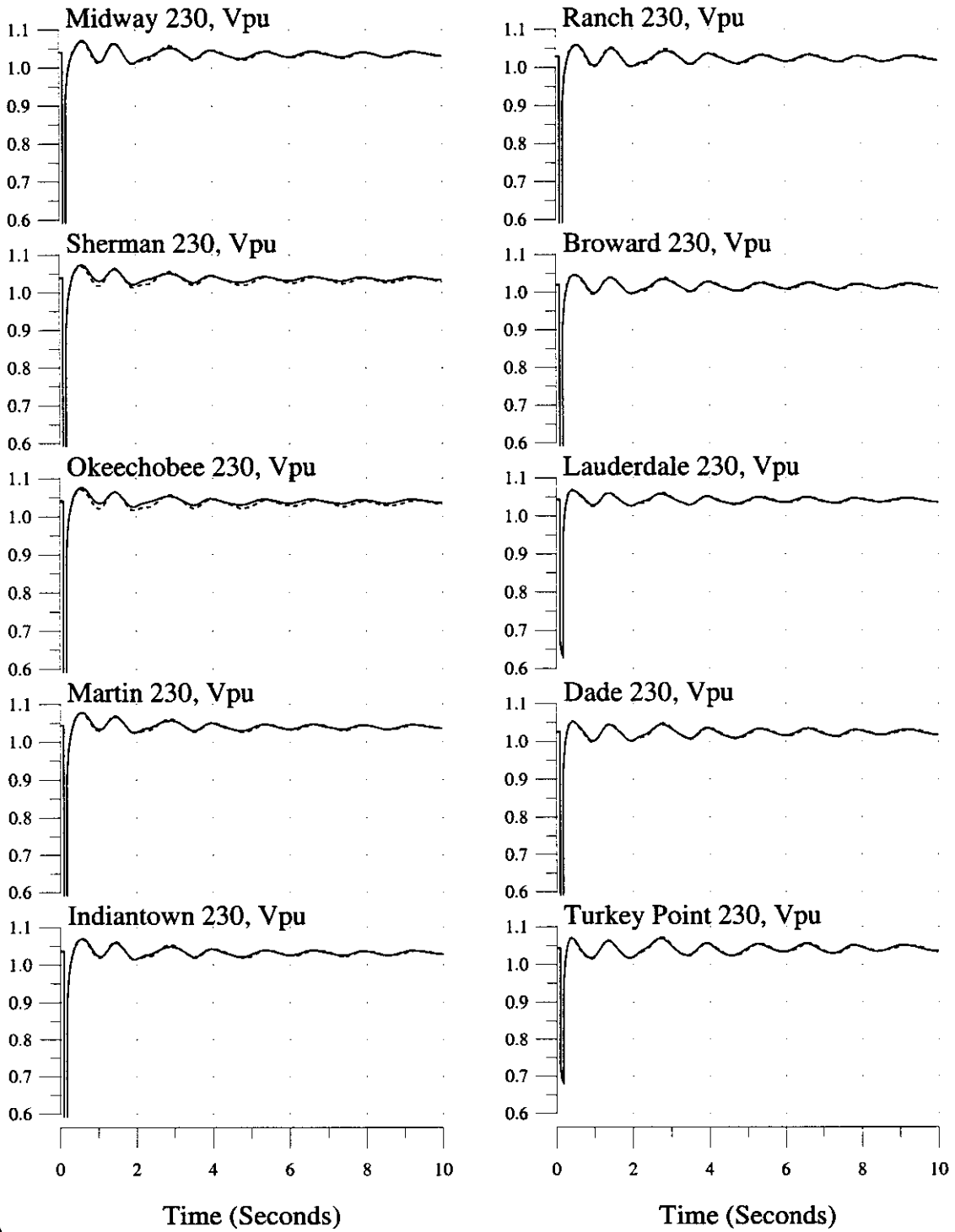

3-phase, 5-cycle Fault at Martin 500kV Bus, Trip Martin #2 & GSU
2003 Summer System

Bus Variables: (—) With Okeechobee TEC Dispatch, (...) Without

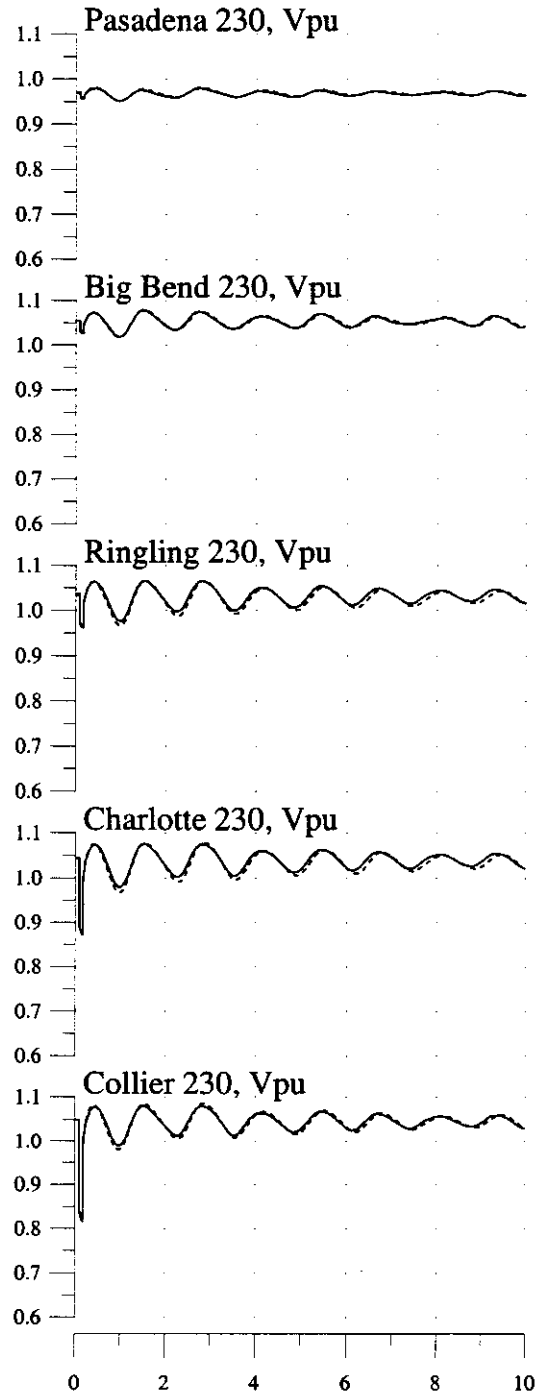
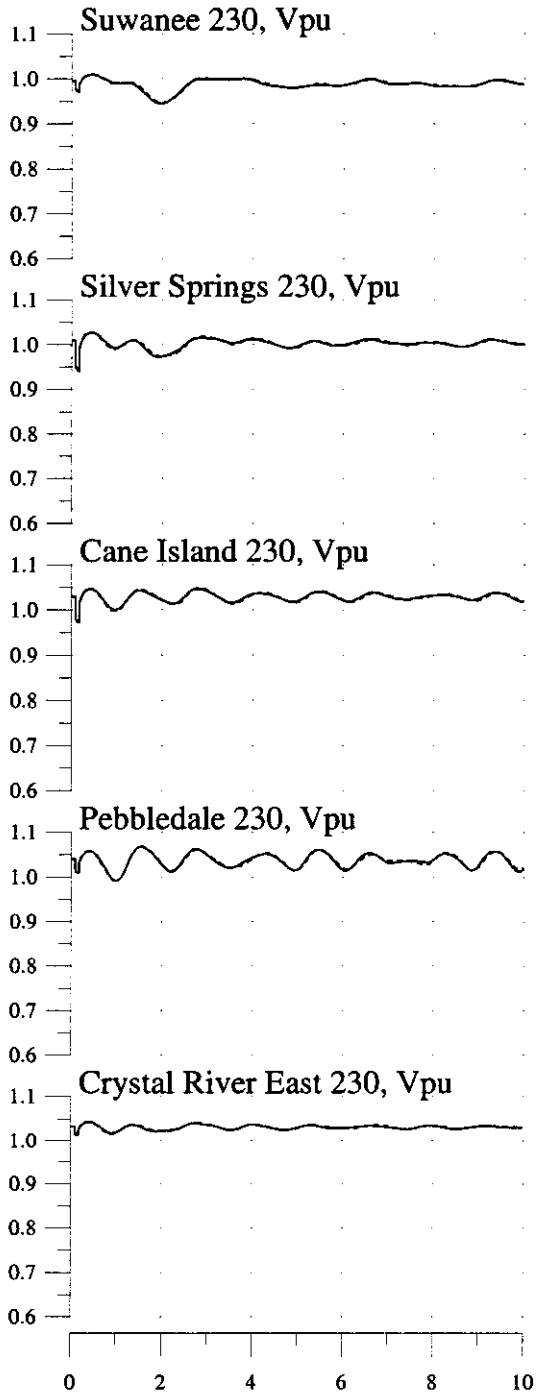

3-phase, 5-cycle Fault at Duval 500kV Bus, Trip Thalmann-Duval 500kV Line
2003 Summer System

Machine & Interface Variables: (—) With Okeechobee TEC Dispatch, (...) Without

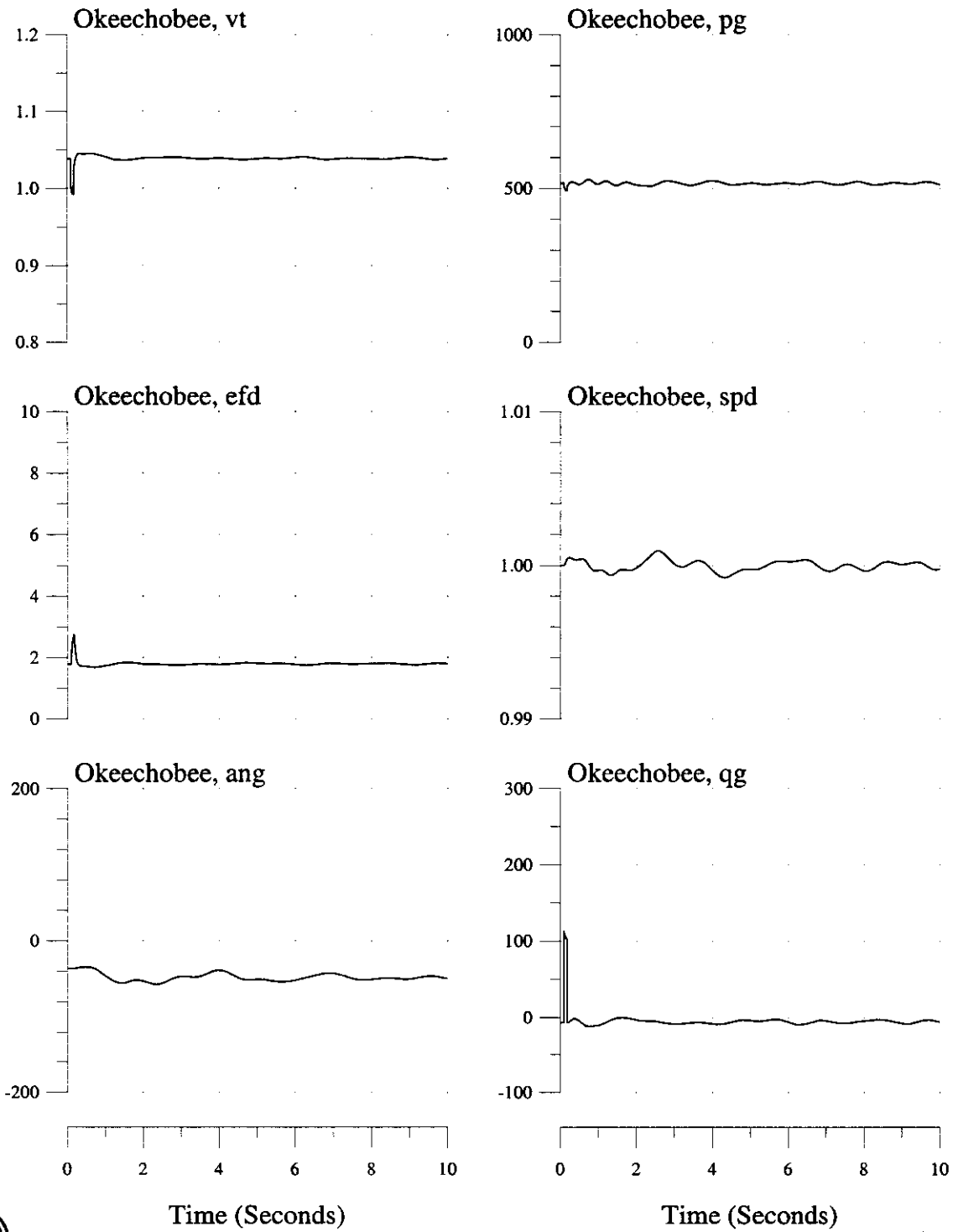

3-phase, 5-cycle Fault at Duval 500kV Bus, Trip Thalmann-Duval 500kV Line
2003 Summer System

Machine & Interface Variables: (—) With Okeechobee TEC Dispatch, (...) Without

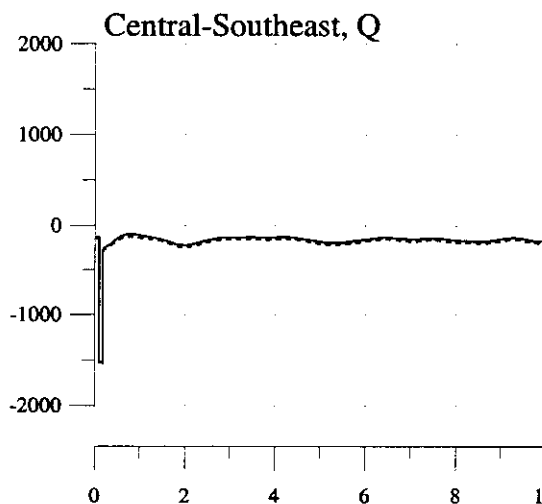
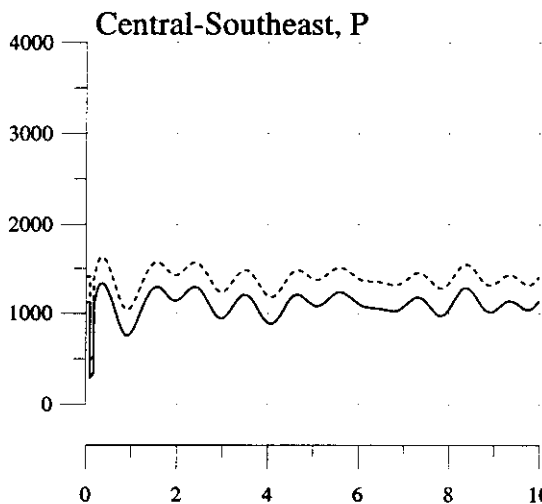
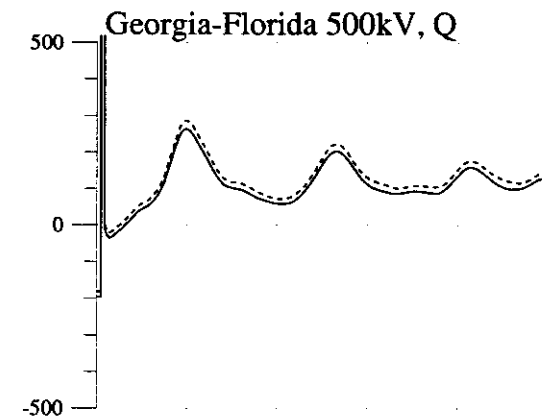
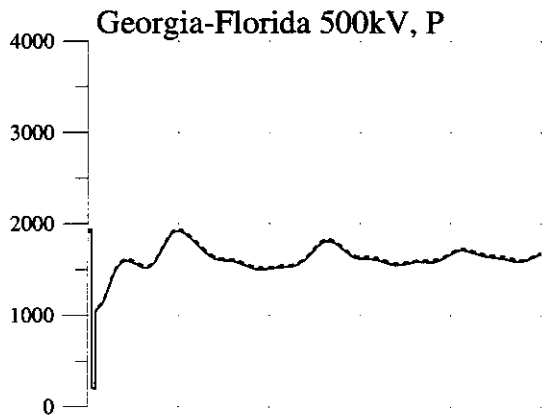
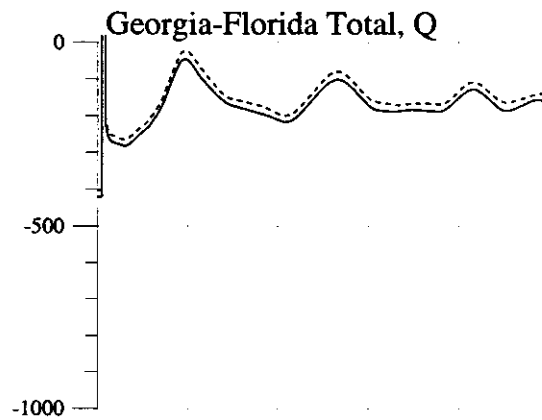
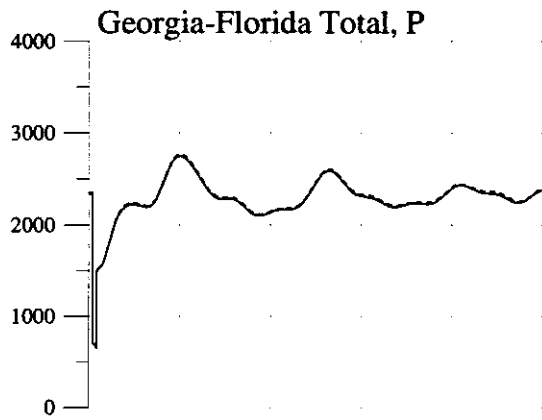

Time (Seconds)

Time (Seconds)



3-phase, 5-cycle Fault at Duval 500kV Bus, Trip Thalmann-Duval 500kV Line
2003 Summer System

Machine Variables: (—) With Okeechobee TEC Dispatch, (...) Without

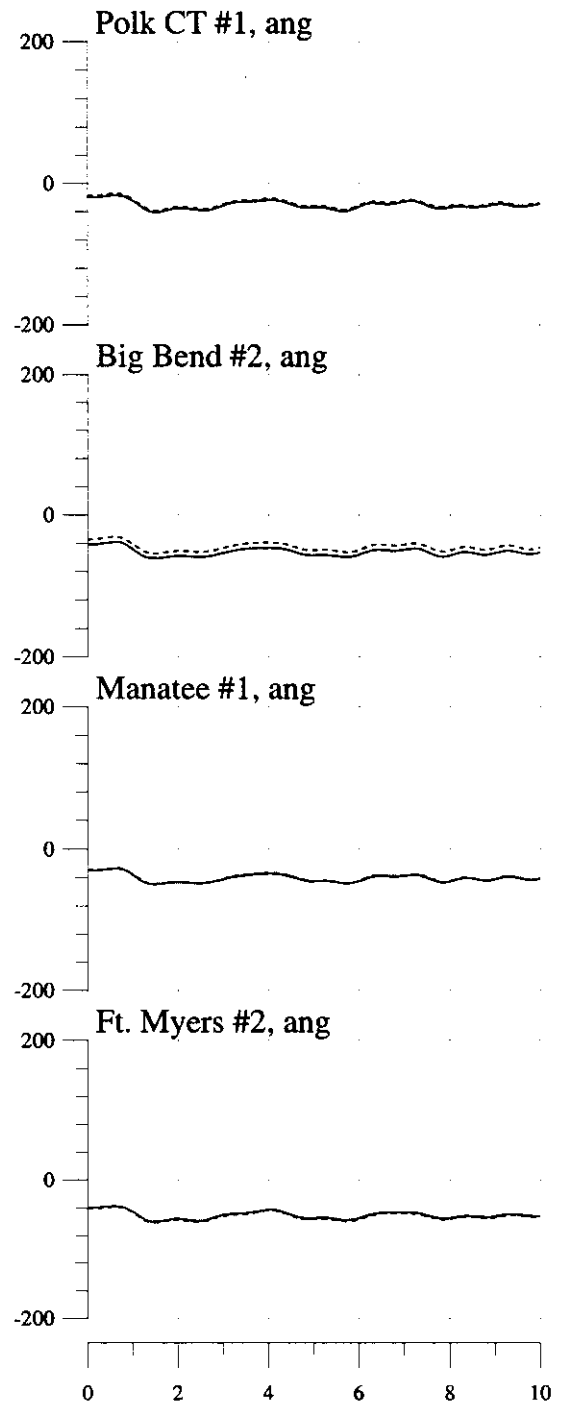
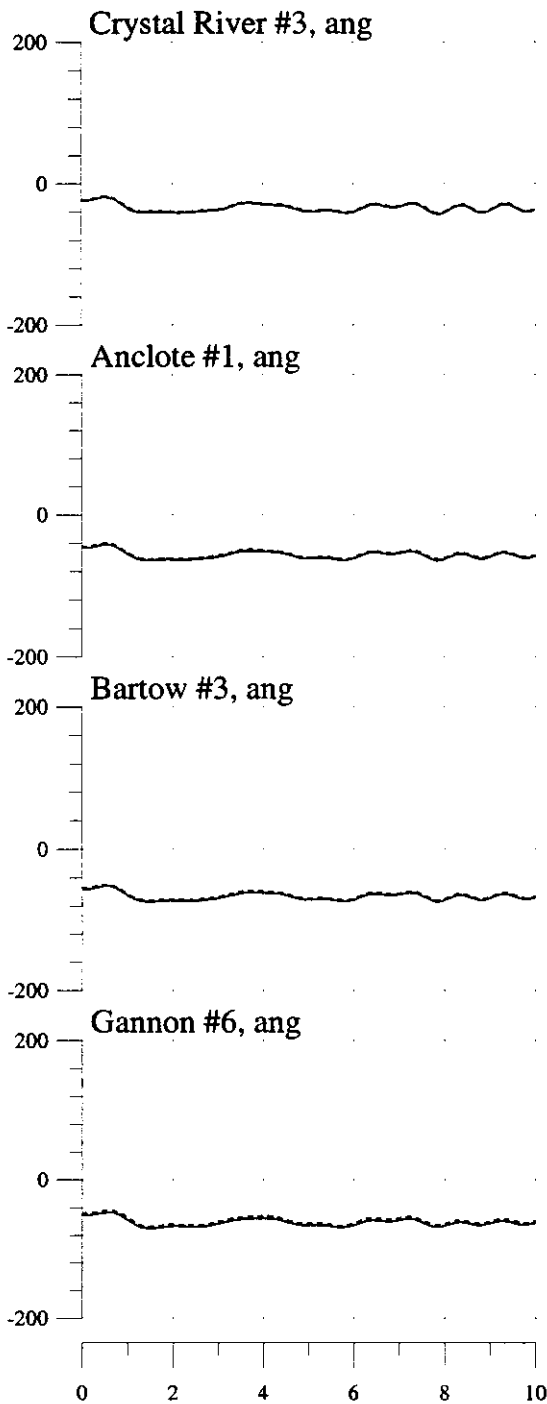

3-phase, 5-cycle Fault at Duval 500kV Bus, Trip Thalmann-Duval 500kV Line
 2003 Summer System

Machine Variables: (—) With Okeechobee TEC Dispatch, (...) Without

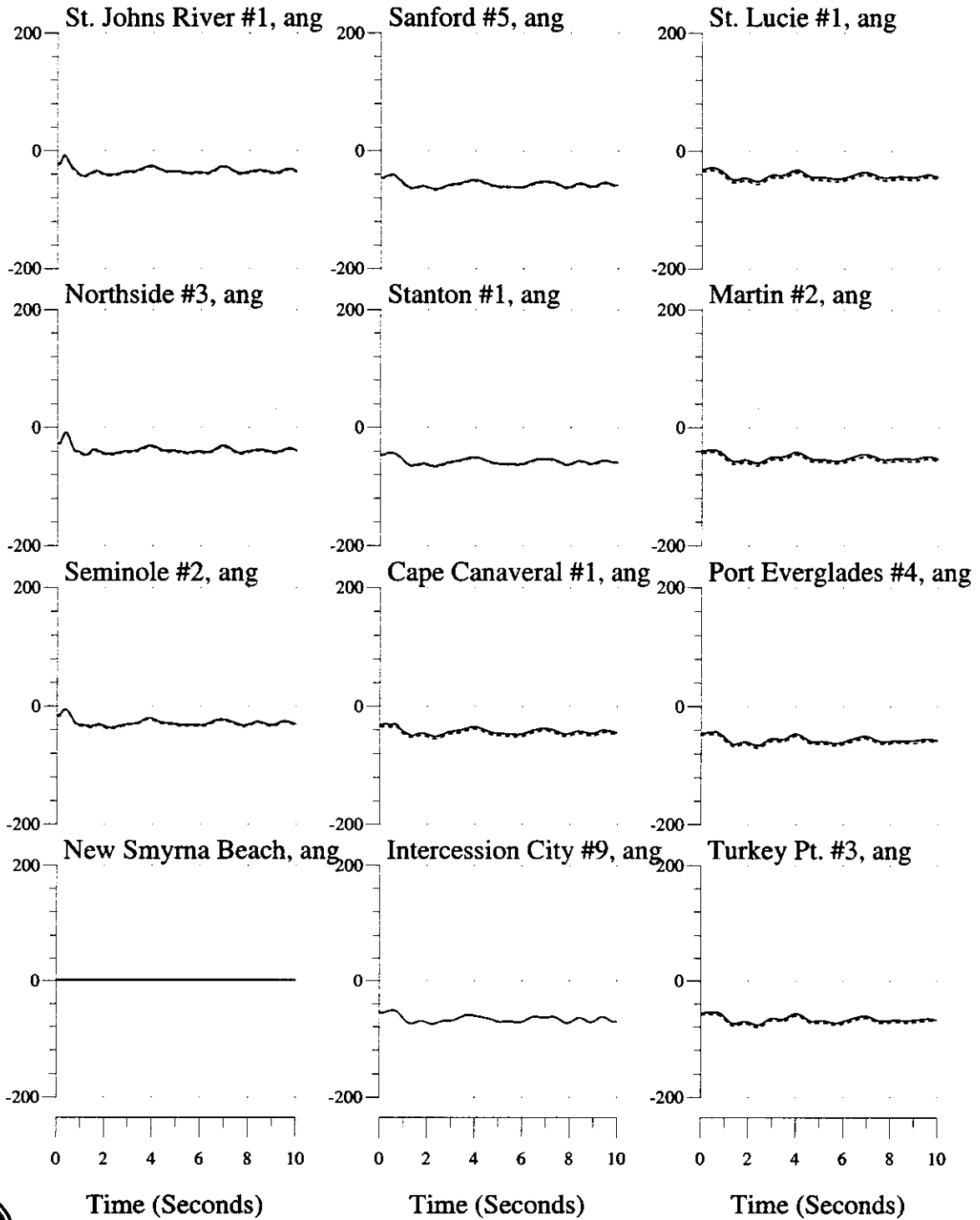

3-phase, 5-cycle Fault at Duval 500kV Bus, Trip Thalmann-Duval 500kV Line
 2003 Summer System

Bus Variables: (—) With Okeechobee TEC Dispatch, (...) Without

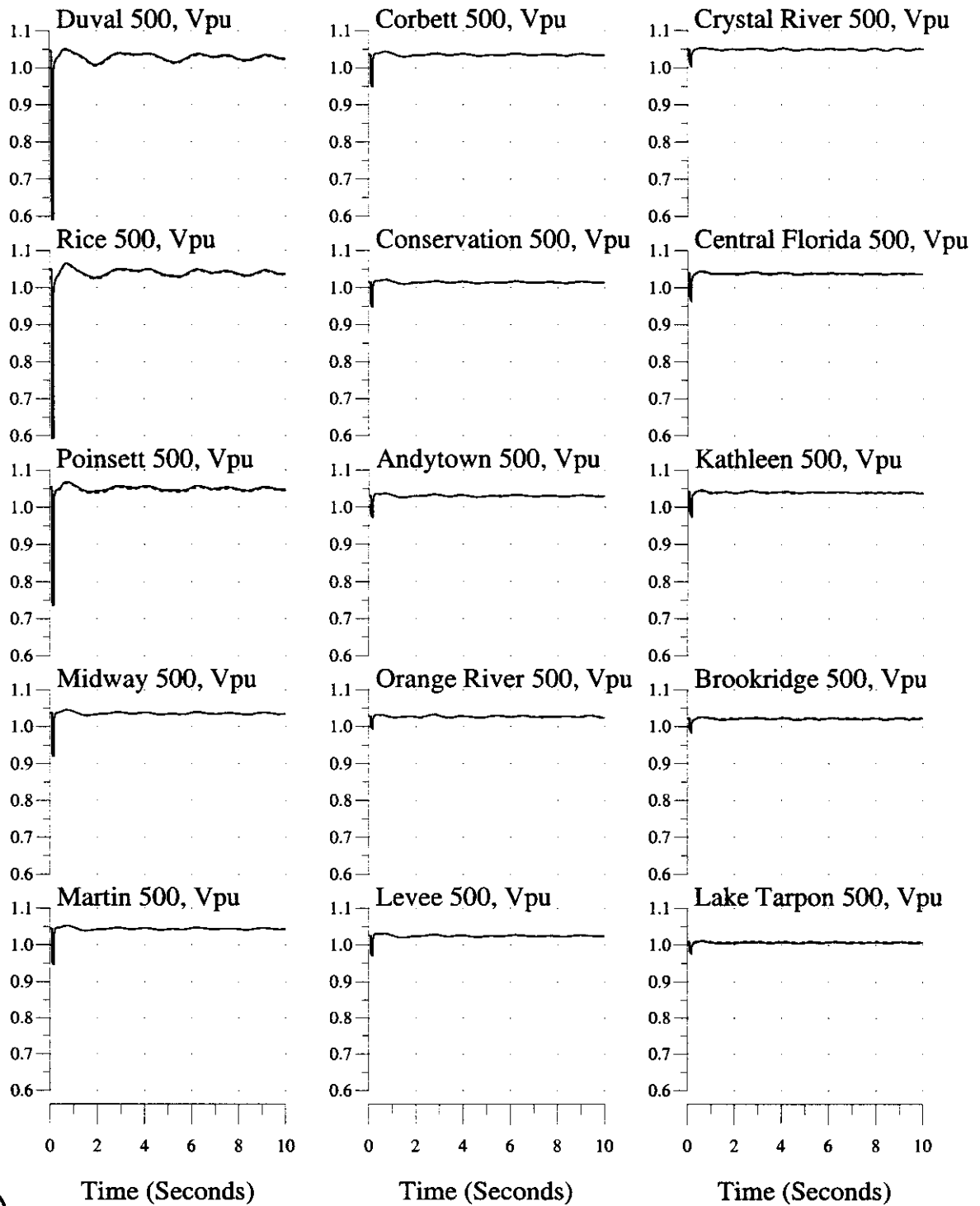

3-phase, 5-cycle Fault at Duval 500kV Bus, Trip Thalmann-Duval 500kV Line
2003 Summer System

Bus Variables: (—) With Okeechobee TEC Dispatch, (...) Without

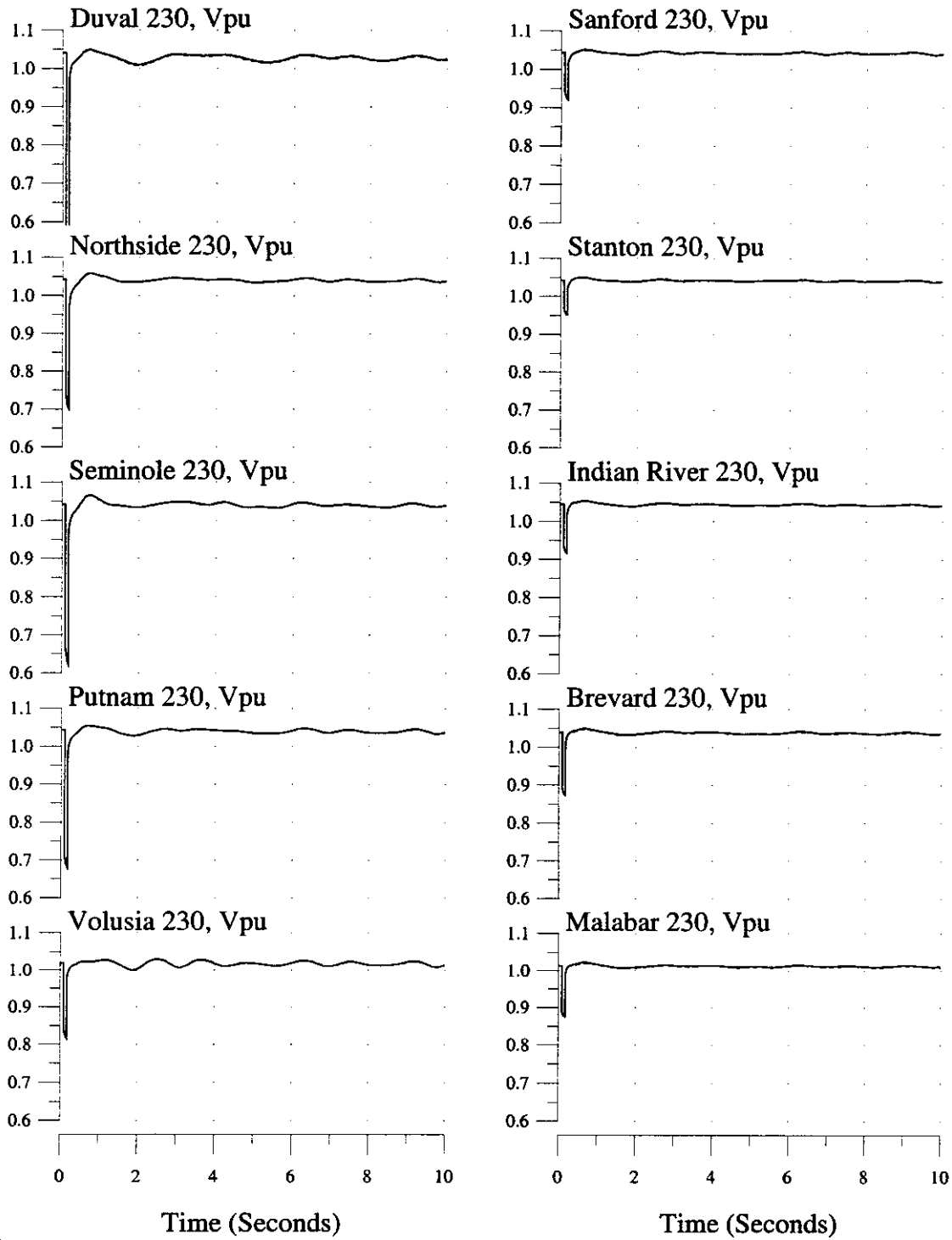

3-phase, 5-cycle Fault at Duval 500kV Bus, Trip Thalmann-Duval 500kV Line
2003 Summer System

Bus Variables: (___) With Okeechobee TEC Dispatch, (...) Without

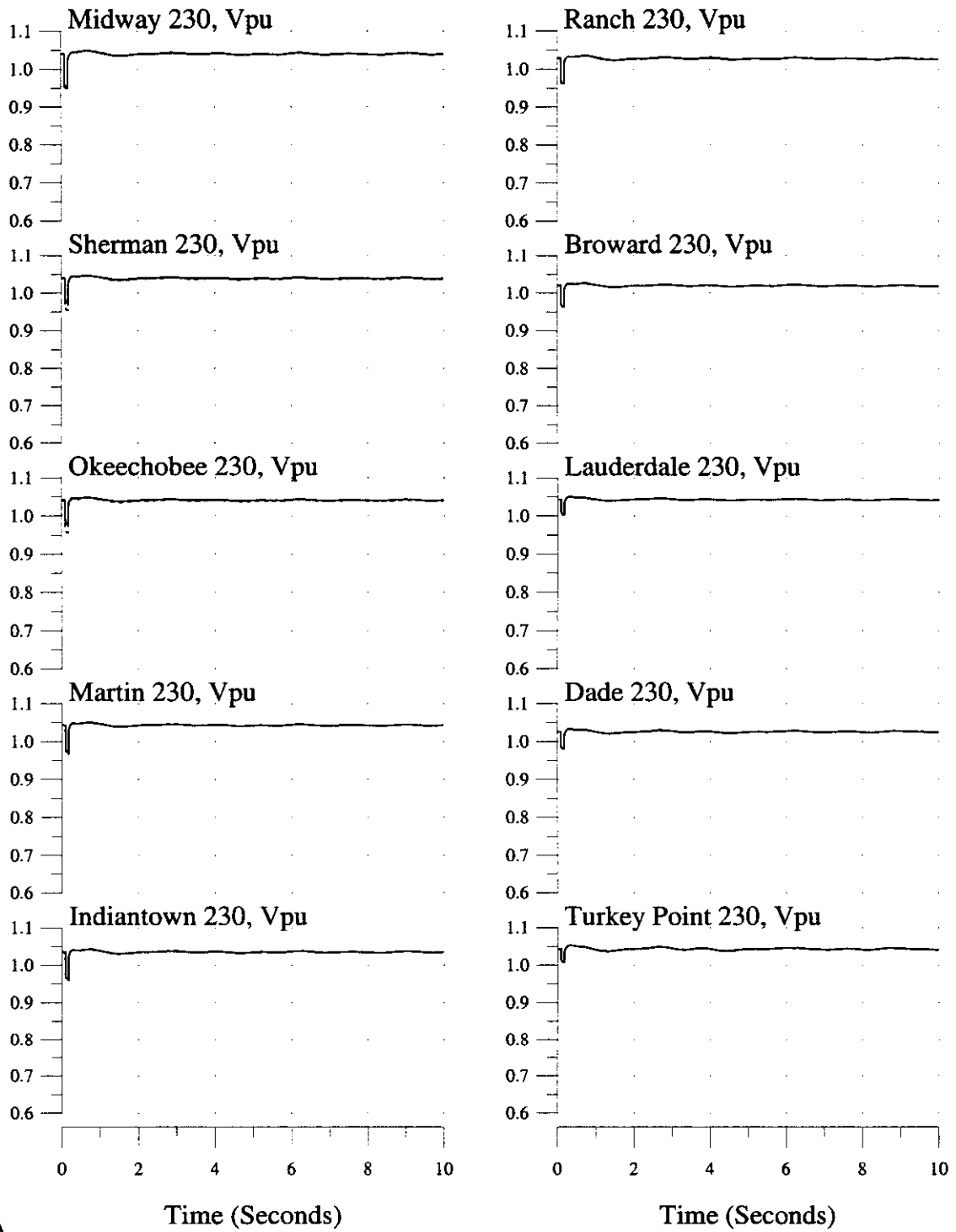

3-phase, 5-cycle Fault at Duval 500kV Bus, Trip Thalmann-Duval 500kV Line
 2003 Summer System

Bus Variables: (—) With Okeechobee TEC Dispatch, (...) Without

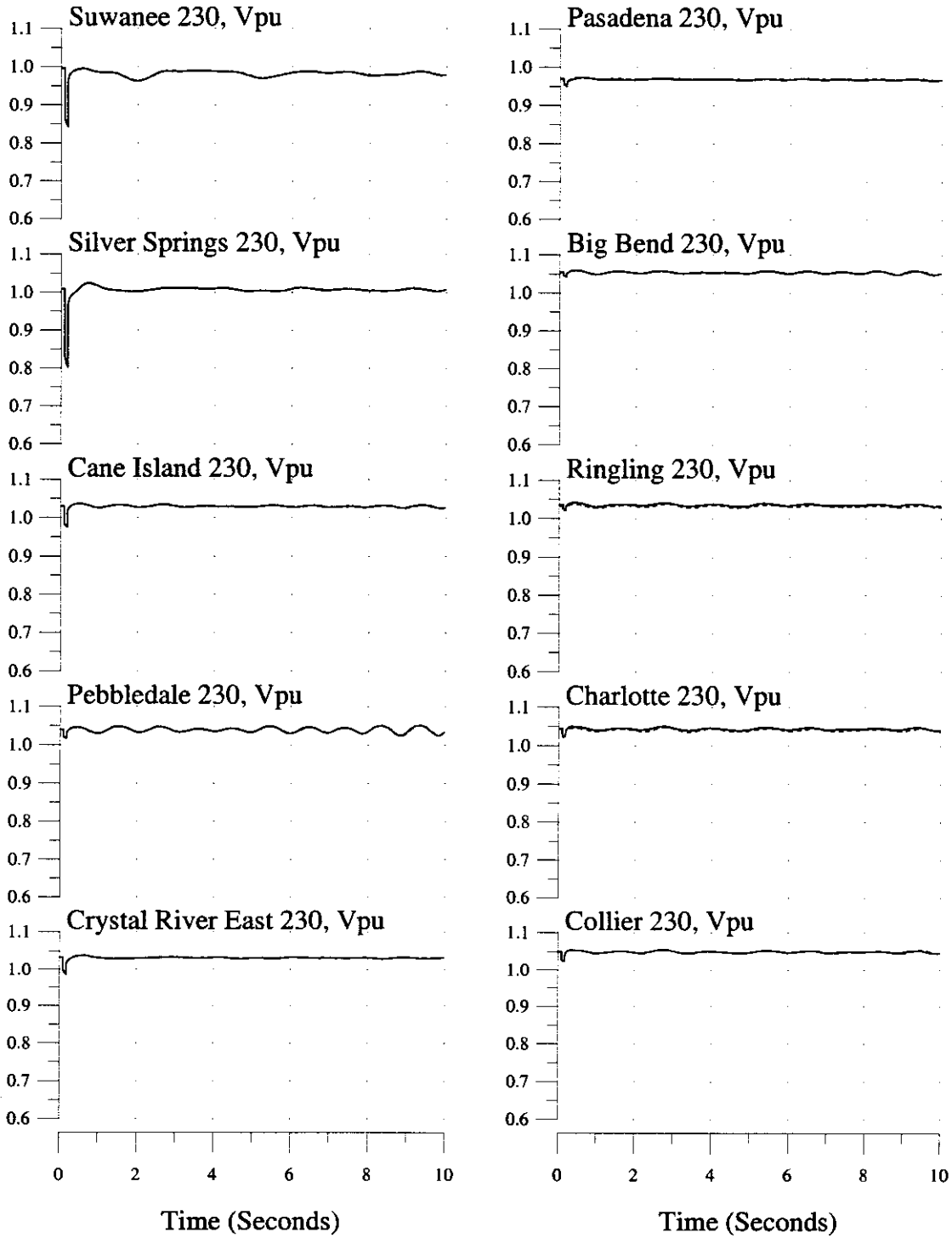

3-phase, 5-cycle Fault at Martin 500kV Bus, Trip Poinsett-Martin 500kV Line
2003 Summer System

Machine & Interface Variables: (—) With Okeechobee TEC Dispatch, (...) Without

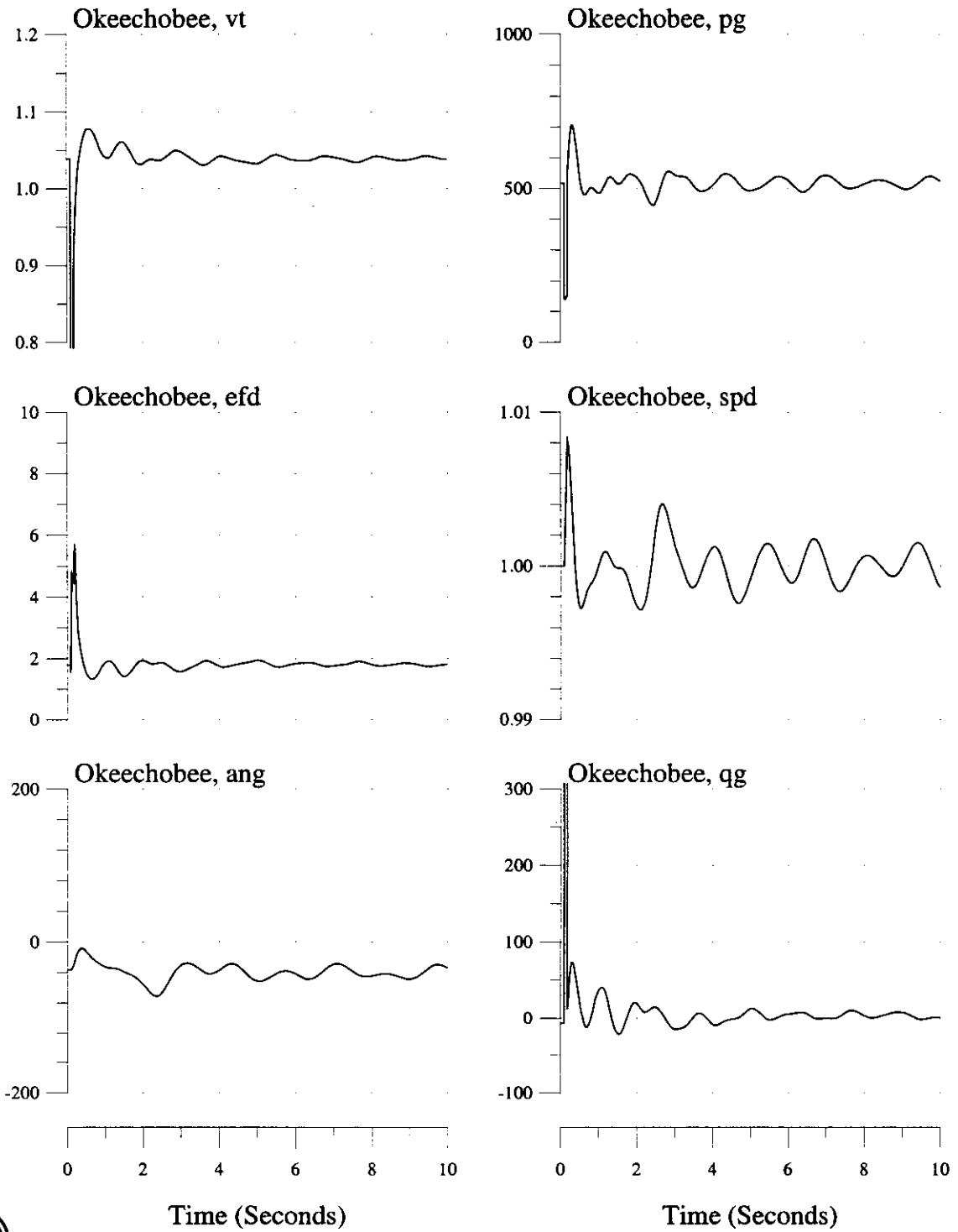

3-phase, 5-cycle Fault at Martin 500kV Bus, Trip Poinsett-Martin 500kV Line
2003 Summer System

Machine & Interface Variables: (___) With Okeechobee TEC Dispatch, (...) Without

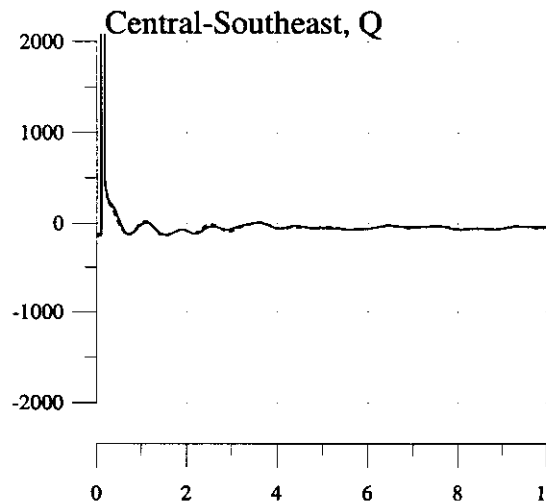
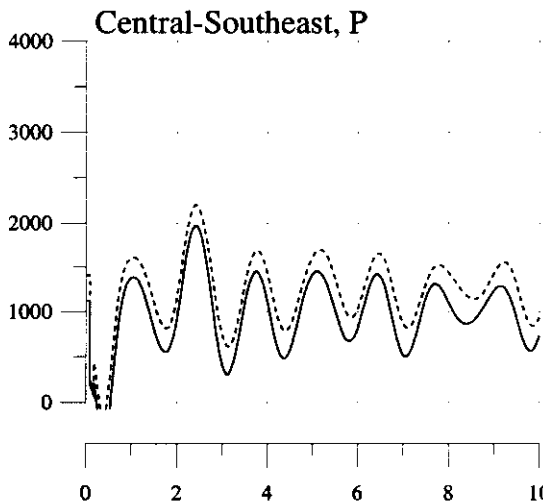
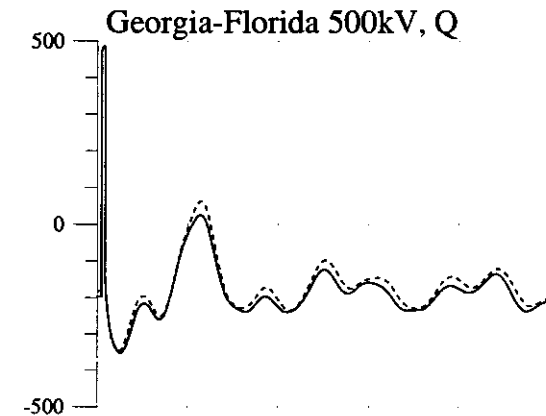
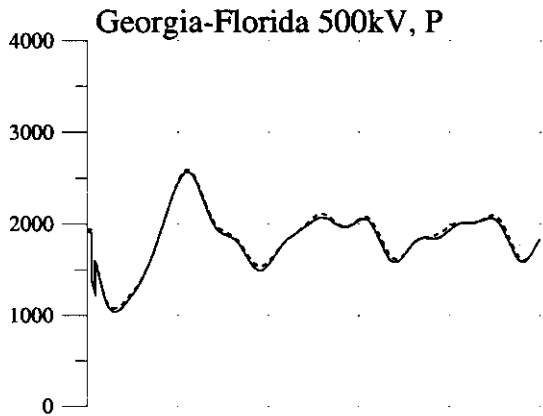
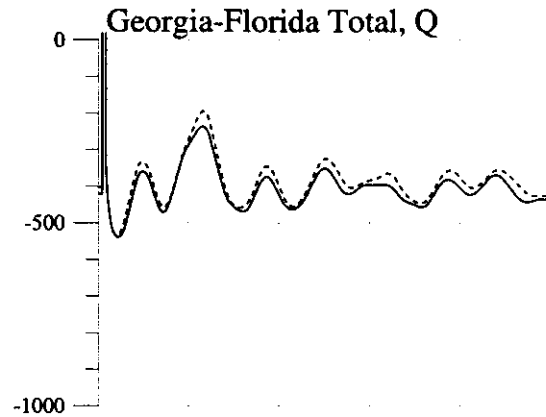
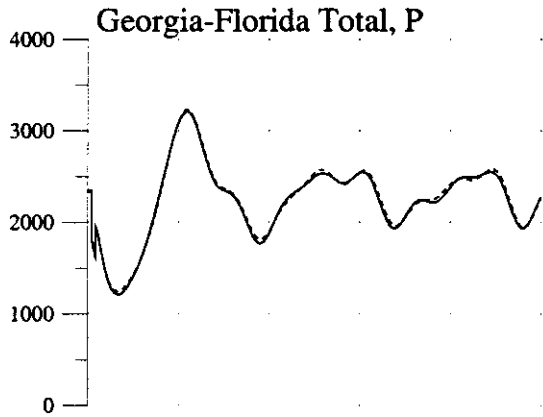

Time (Seconds)

Time (Seconds)



3-phase, 5-cycle Fault at Martin 500kV Bus, Trip Poinsett-Martin 500kV Line
2003 Summer System

Machine Variables: (—) With Okeechobee TEC Dispatch, (...) Without

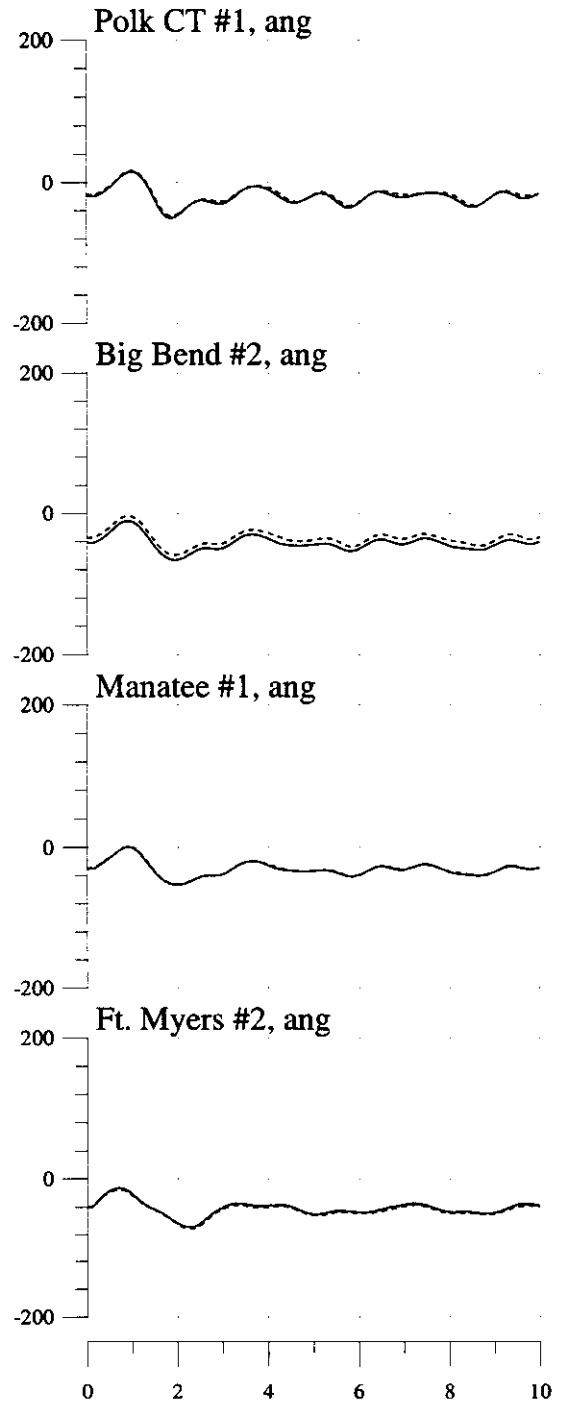
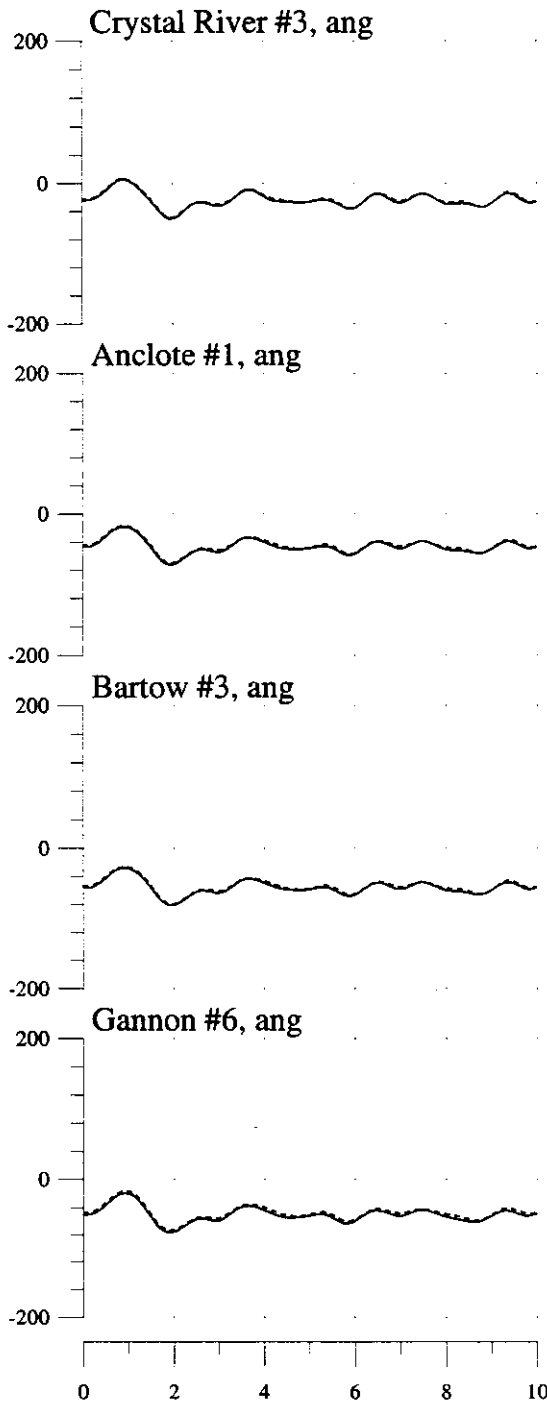

3-phase, 5-cycle Fault at Martin 500kV Bus, Trip Poinsett-Martin 500kV Line
 2003 Summer System

Machine Variables: (—) With Okeechobee TEC Dispatch, (...) Without

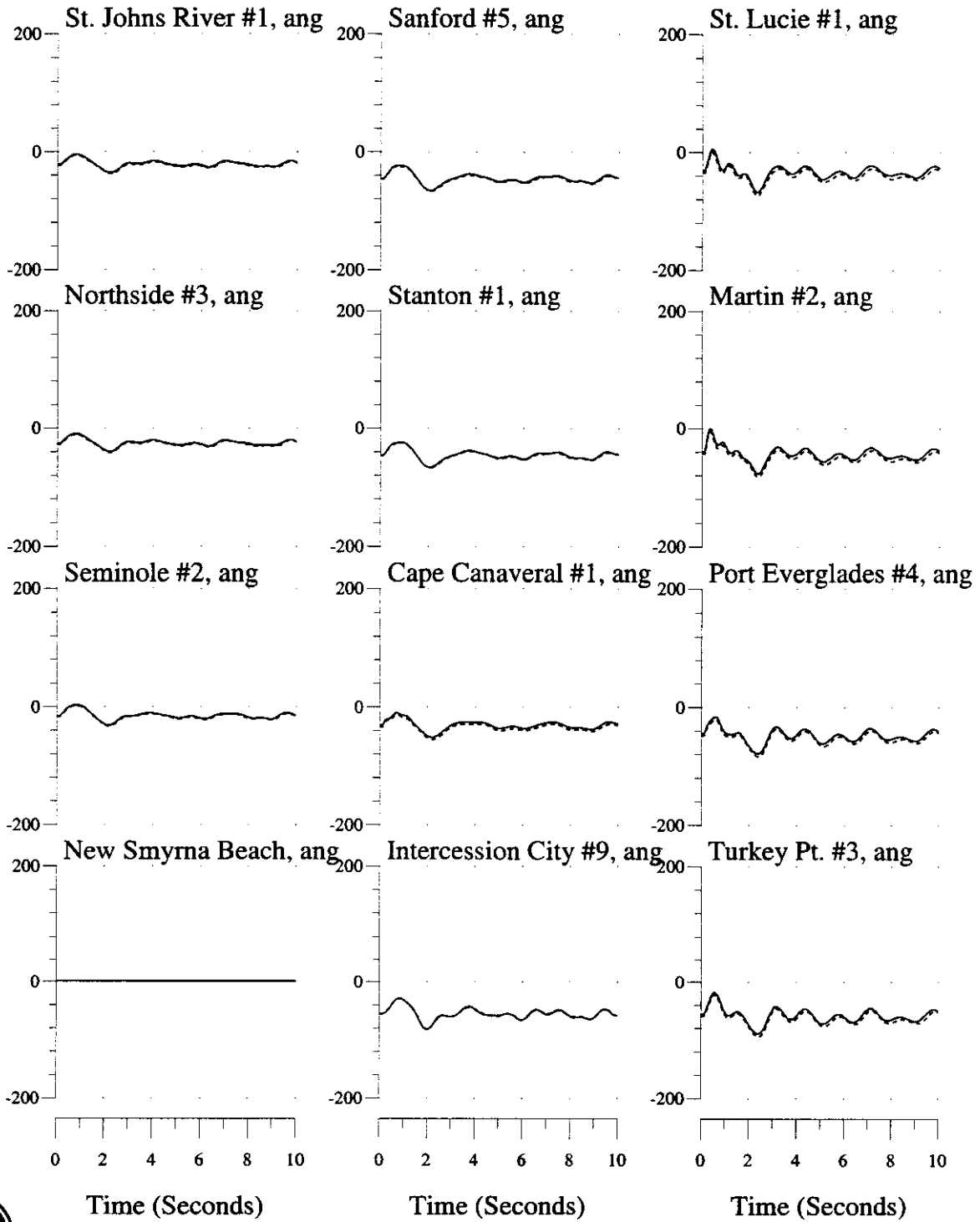

3-phase, 5-cycle Fault at Martin 500kV Bus, Trip Poinsett-Martin 500kV Line
 2003 Summer System

Bus Variables: (—) With Okeechobee TEC Dispatch, (...) Without

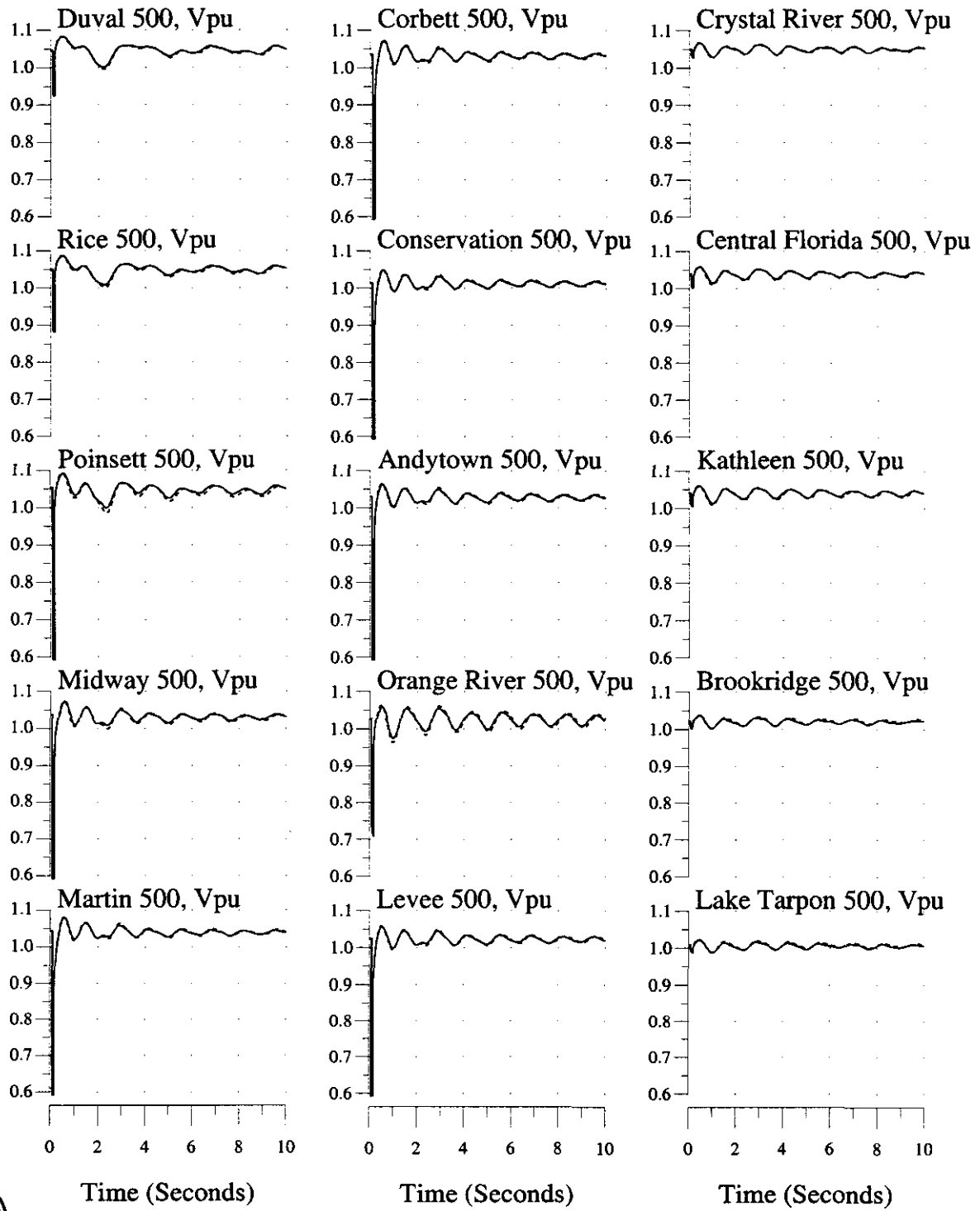

3-phase, 5-cycle Fault at Martin 500kV Bus, Trip Poinsett-Martin 500kV Line
2003 Summer System

Bus Variables: (—) With Okeechobee TEC Dispatch, (...) Without

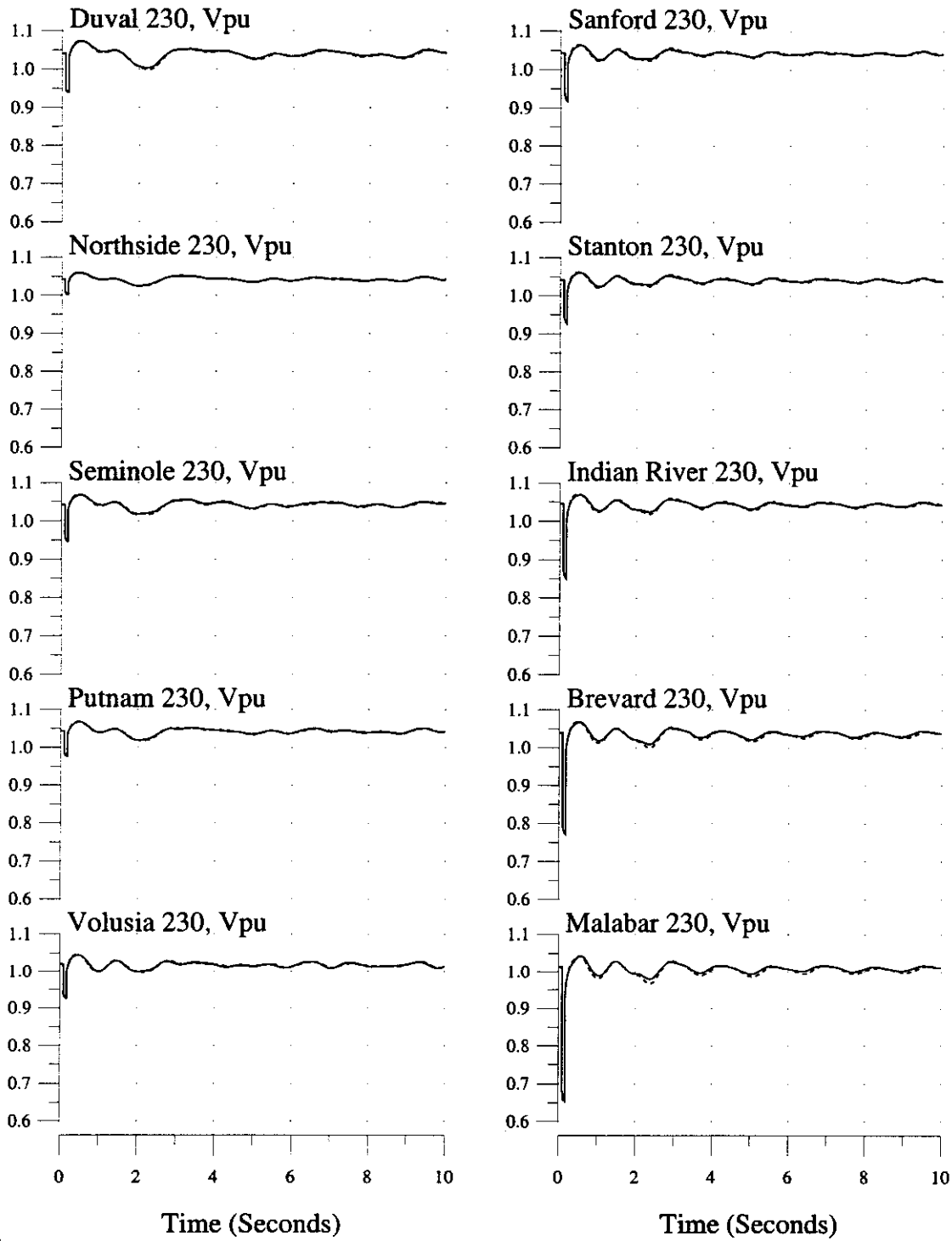

3-phase, 5-cycle Fault at Martin 500kV Bus, Trip Poinsett-Martin 500kV Line
2003 Summer System

Bus Variables: (—) With Okeechobee TEC Dispatch, (...) Without

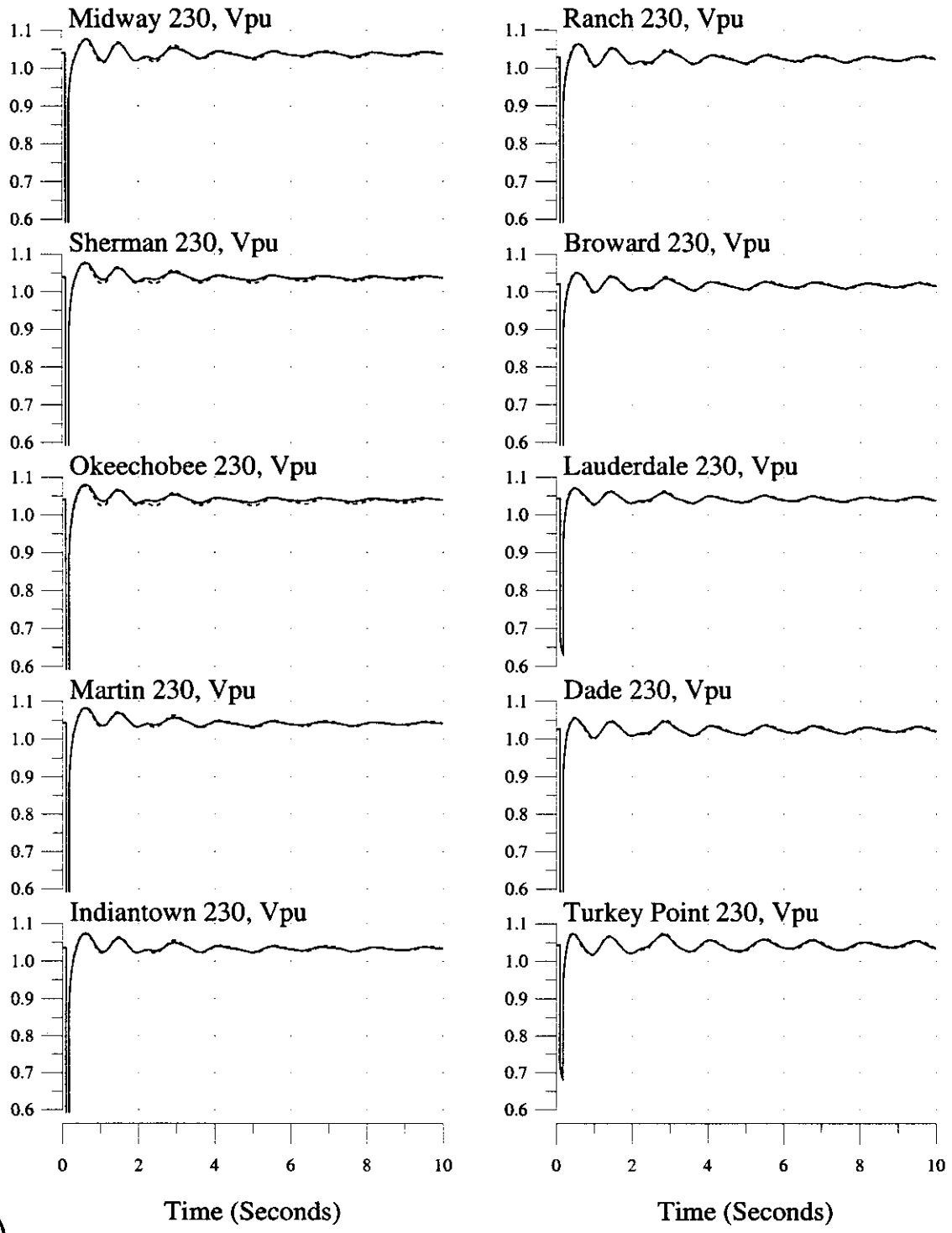

3-phase, 5-cycle Fault at Martin 500kV Bus, Trip Poinsett-Martin 500kV Line
2003 Summer System

Bus Variables: (—) With Okeechobee TEC Dispatch, (...) Without

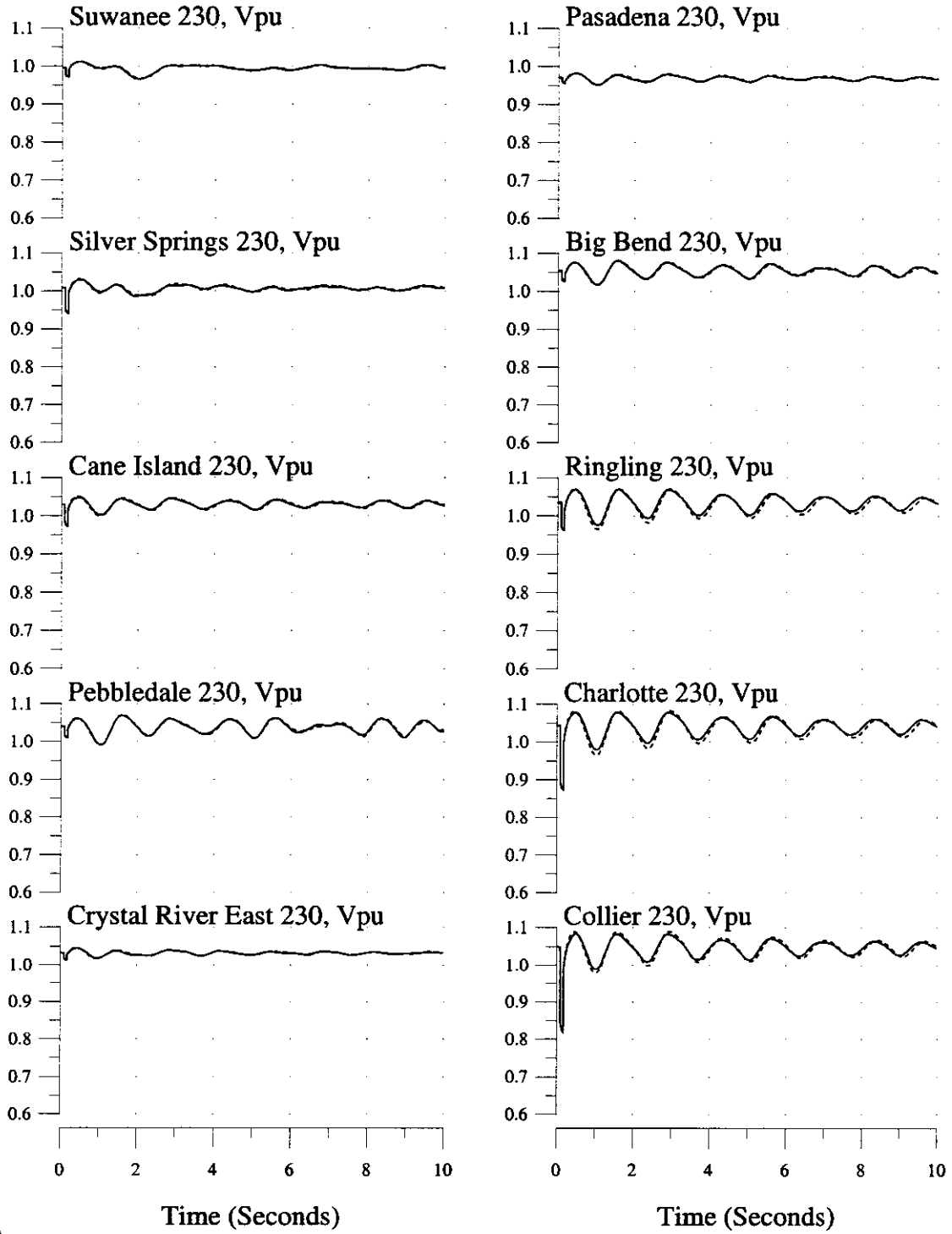

3-phase, 5-cycle Fault at Okeechobee 230kV Bus, Trip Okeechobee-Sherman 230kV Line
2003 Summer System

Machine & Interface Variables: (___) With Okeechobee TEC Dispatch, (...) Without

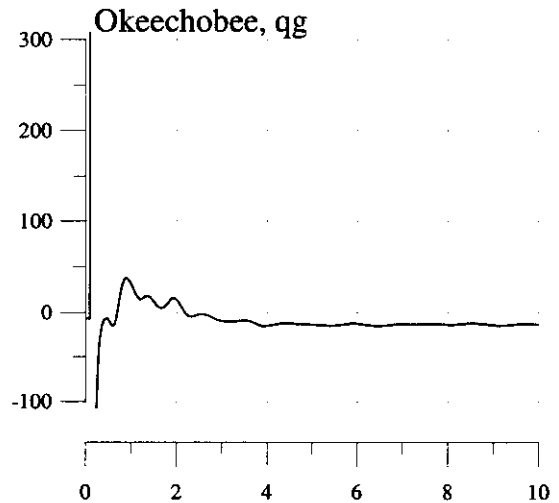
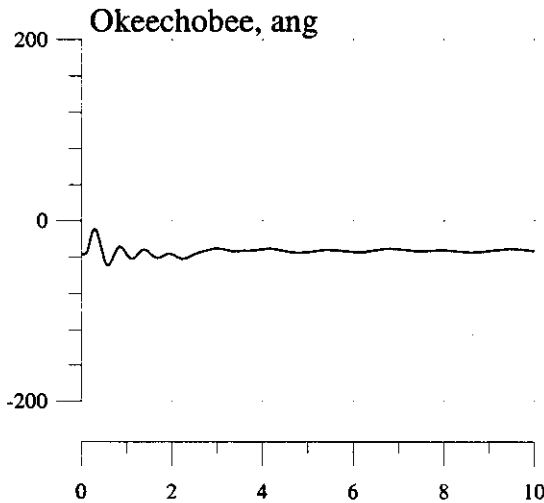
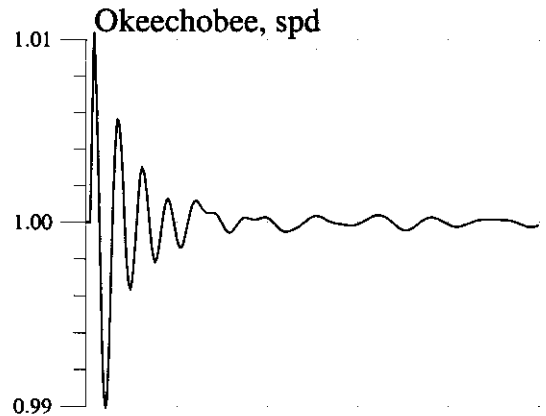
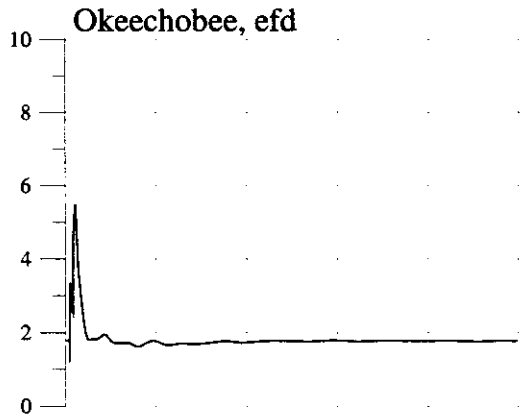
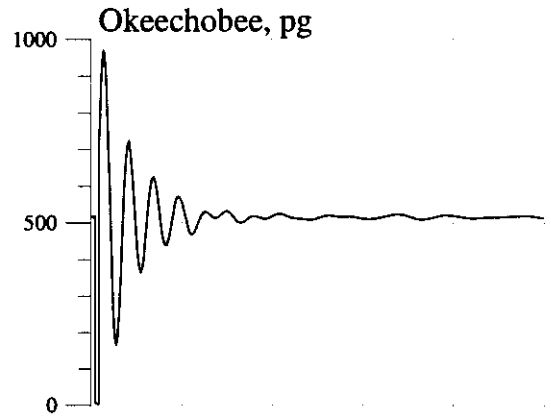
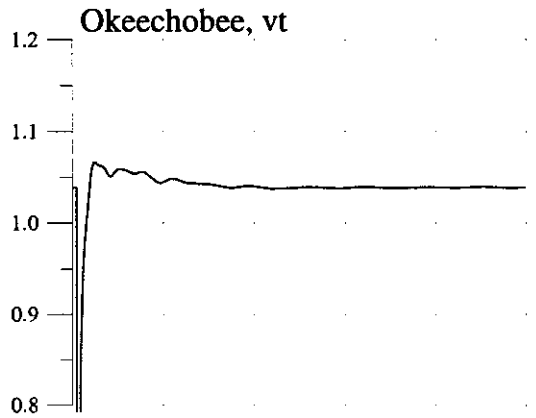

Time (Seconds)

Time (Seconds)



3-phase, 5-cycle Fault at Okeechobee 230kV Bus, Trip Okeechobee-Sherman 230kV Line
 2003 Summer System

Machine & Interface Variables: (___) With Okeechobee TEC Dispatch, (...) Without

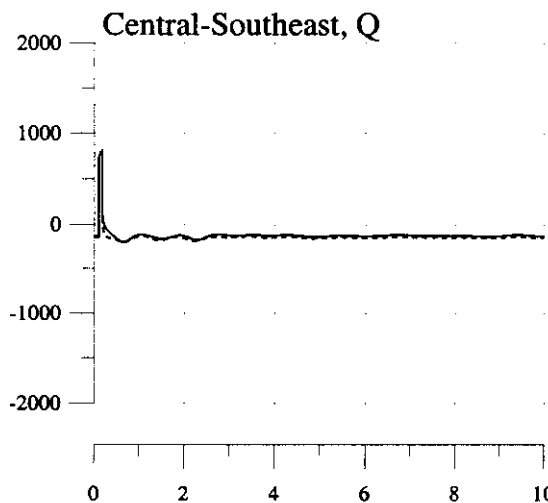
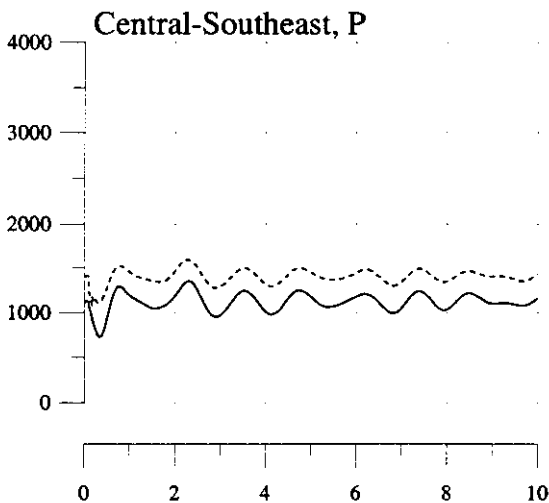
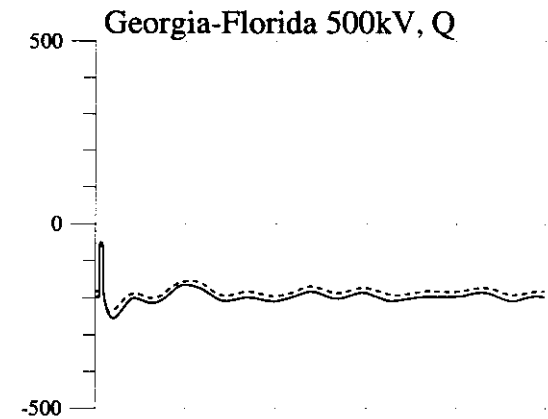
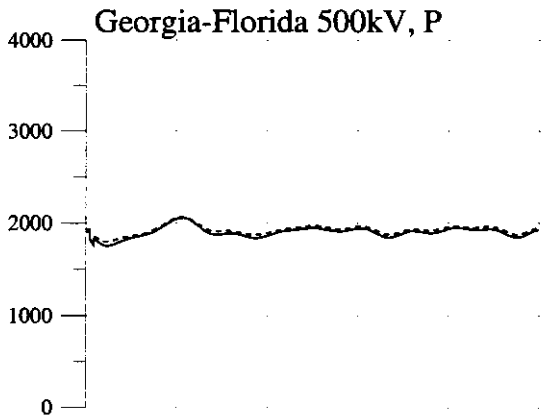
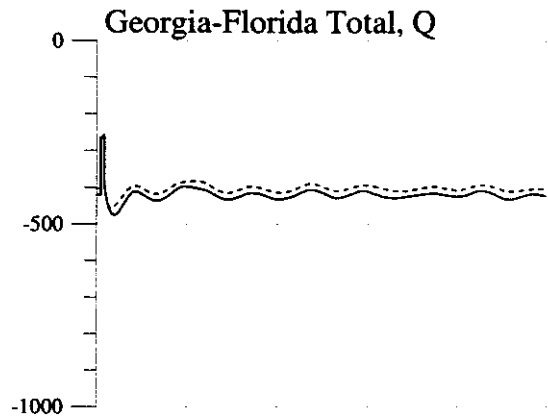
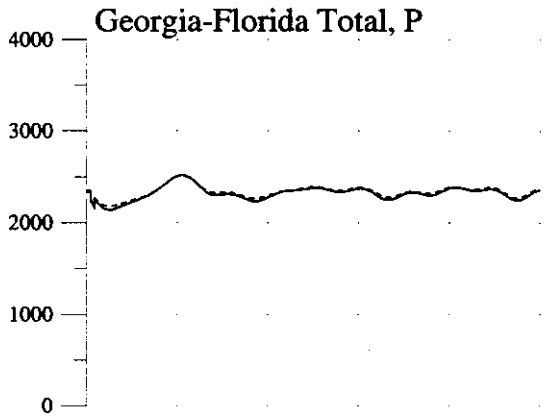

Time (Seconds)

Time (Seconds)



3-phase, 5-cycle Fault at Okeechobee 230kV Bus, Trip Okeechobee-Sherman 230kV Line
2003 Summer System

Machine Variables: (—) With Okeechobee TEC Dispatch, (...) Without

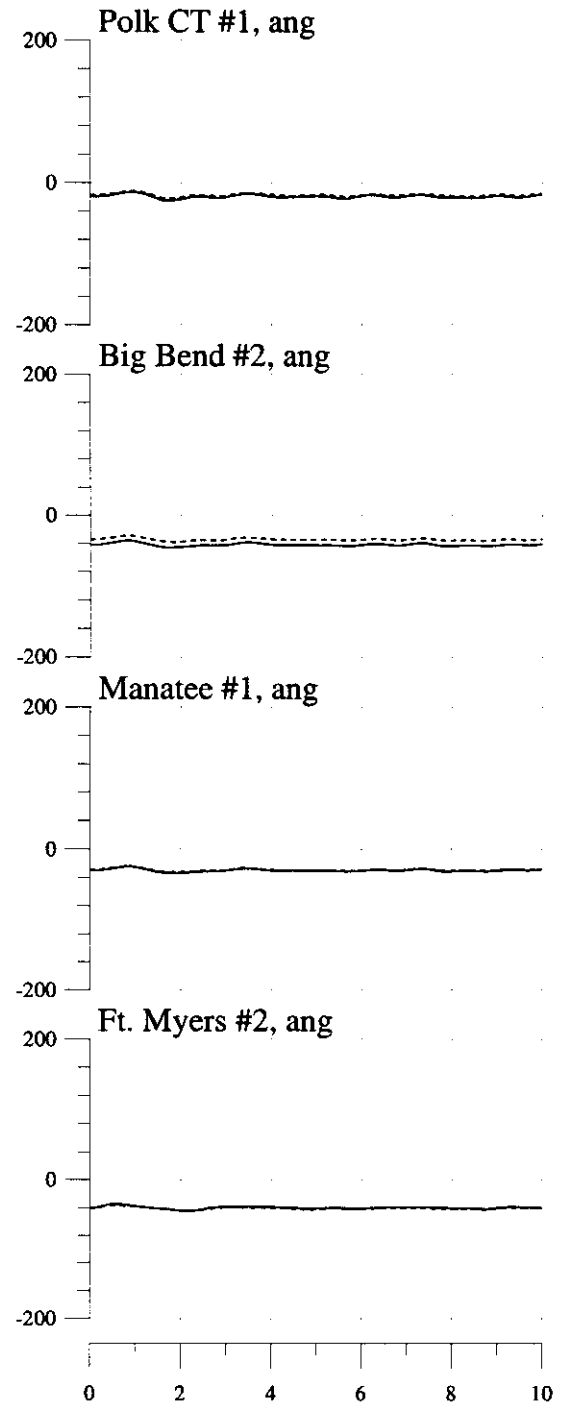
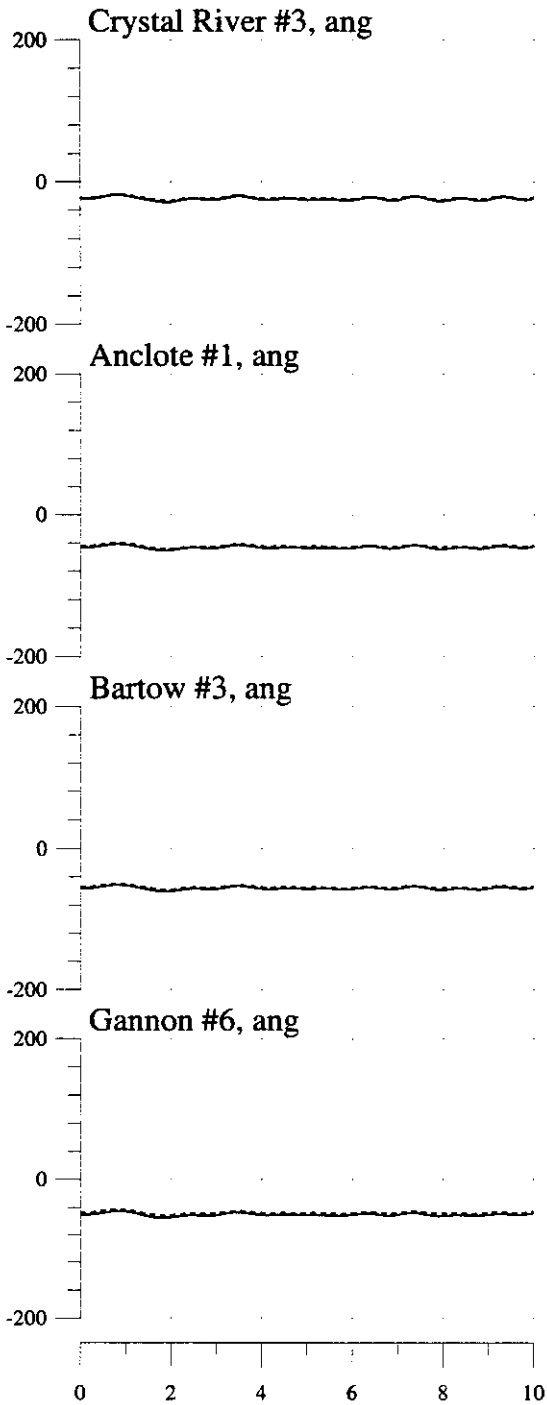

3-phase, 5-cycle Fault at Okeechobee 230kV Bus, Trip Okeechobee-Sherman 230kV Line
 2003 Summer System

Machine Variables: (—) With Okeechobee TEC Dispatch, (...) Without

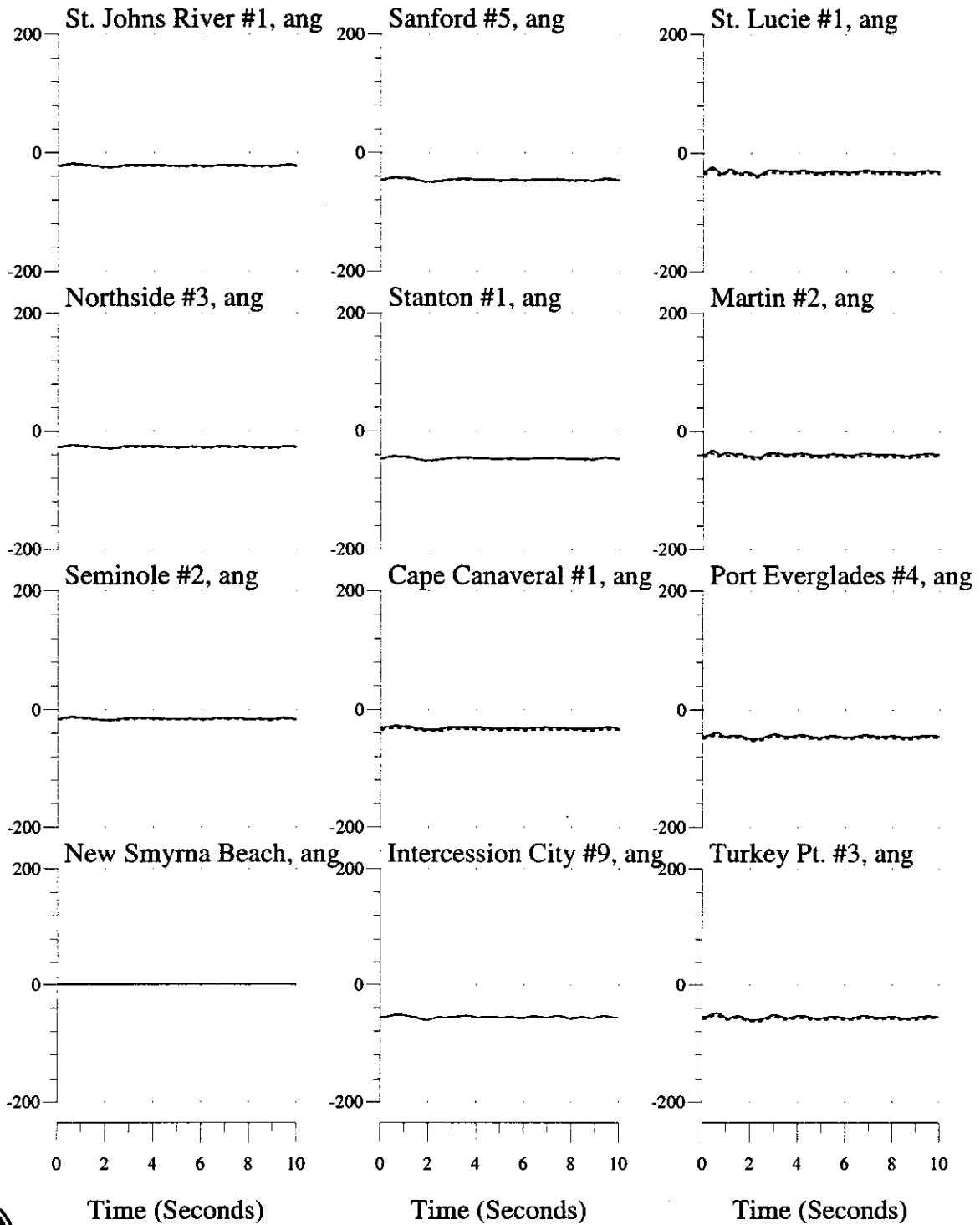

3-phase, 5-cycle Fault at Okeechobee 230kV Bus, Trip Okeechobee-Sherman 230kV Line
 2003 Summer System

Bus Variables: (—) With Okeechobee TEC Dispatch, (...) Without

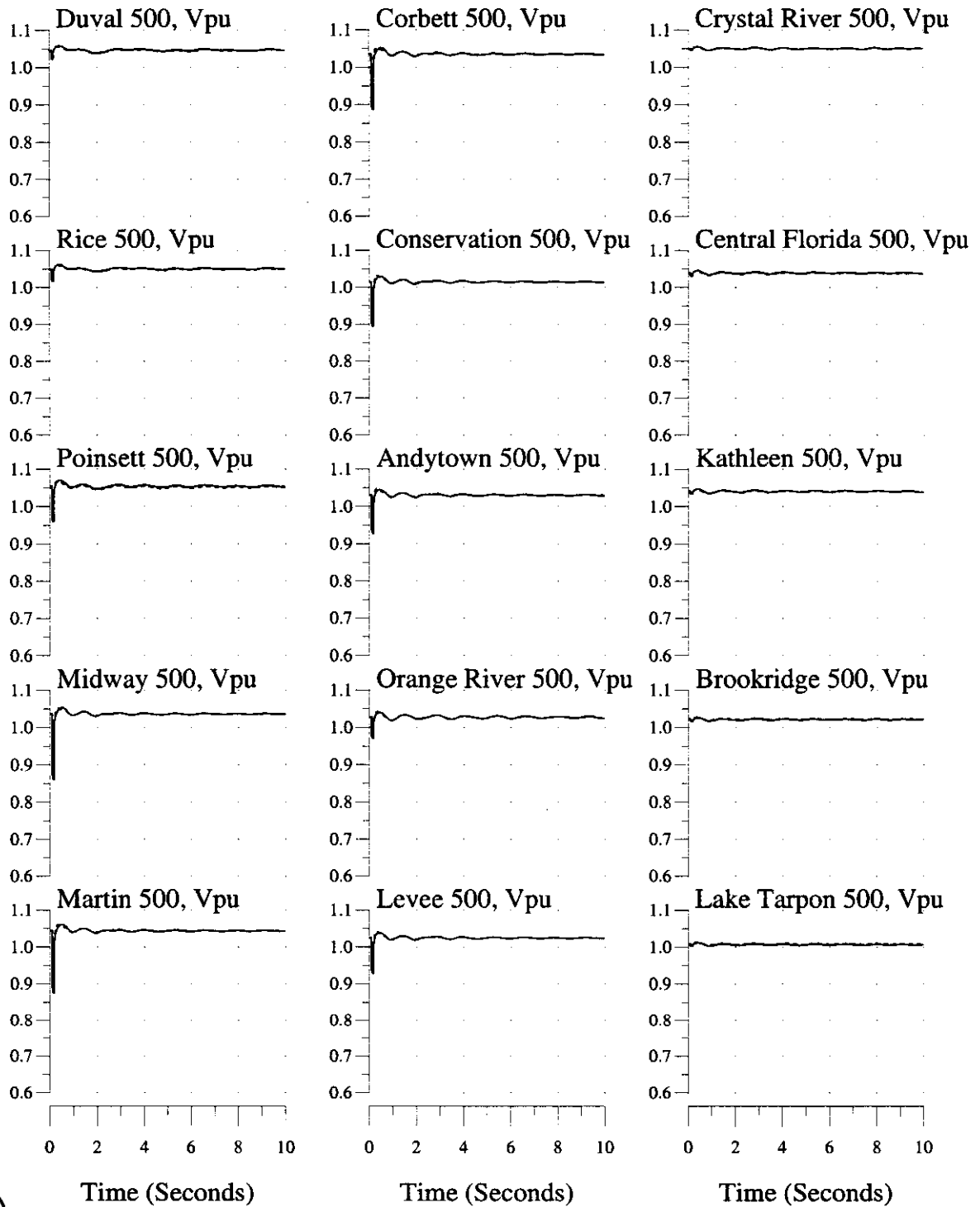

3-phase, 5-cycle Fault at Okeechobee 230kV Bus, Trip Okeechobee-Sherman 230kV Line
 2003 Summer System

Bus Variables: (—) With Okeechobee TEC Dispatch, (...) Without

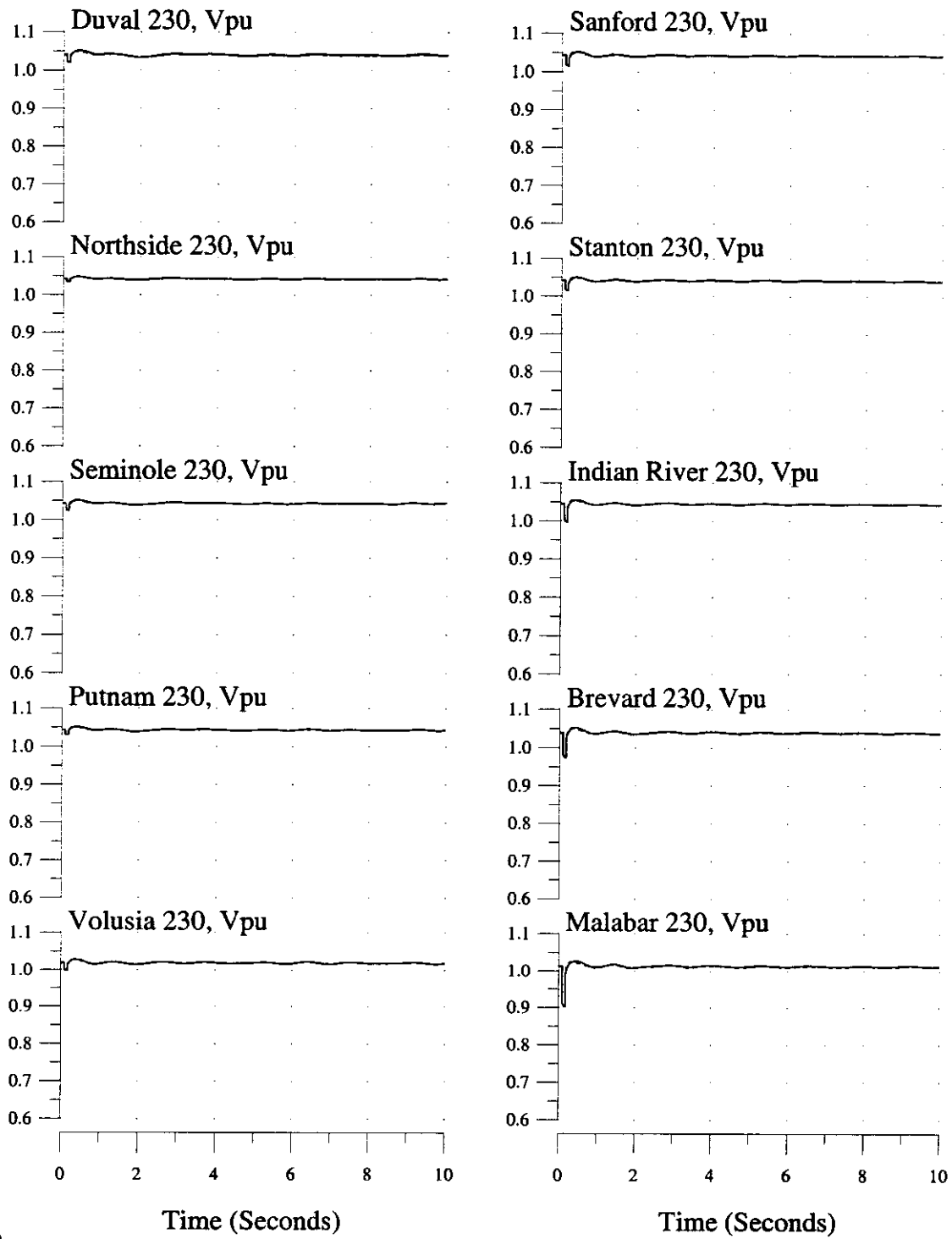

3-phase, 5-cycle Fault at Okeechobee 230kV Bus, Trip Okeechobee-Sherman 230kV Line 2003 Summer System

Bus Variables: (—) With Okeechobee TEC Dispatch, (...) Without

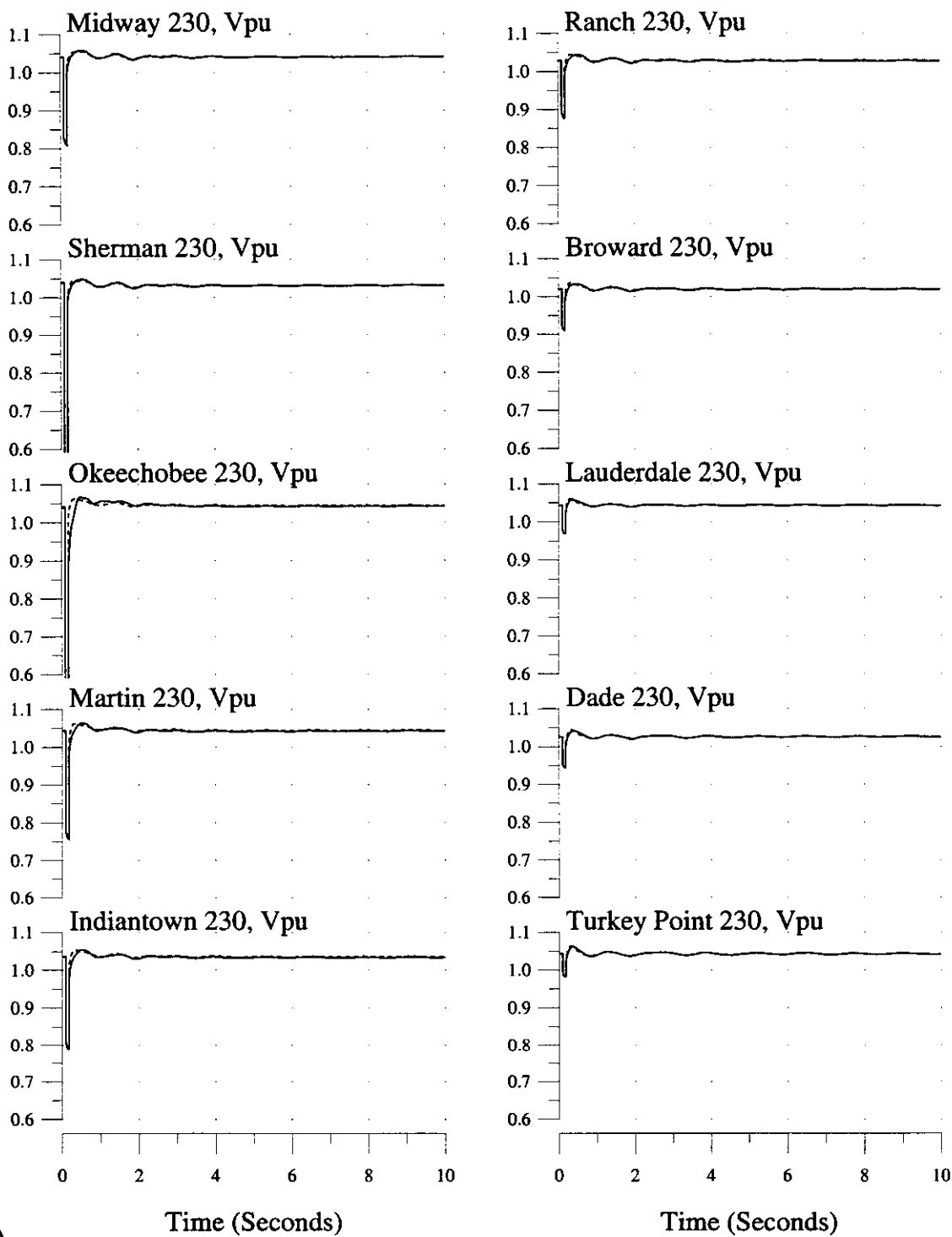

3-phase, 5-cycle Fault at Okeechobee 230kV Bus, Trip Okeechobee-Sherman 230kV Line
2003 Summer System

Bus Variables: (—) With Okeechobee TEC Dispatch, (...) Without

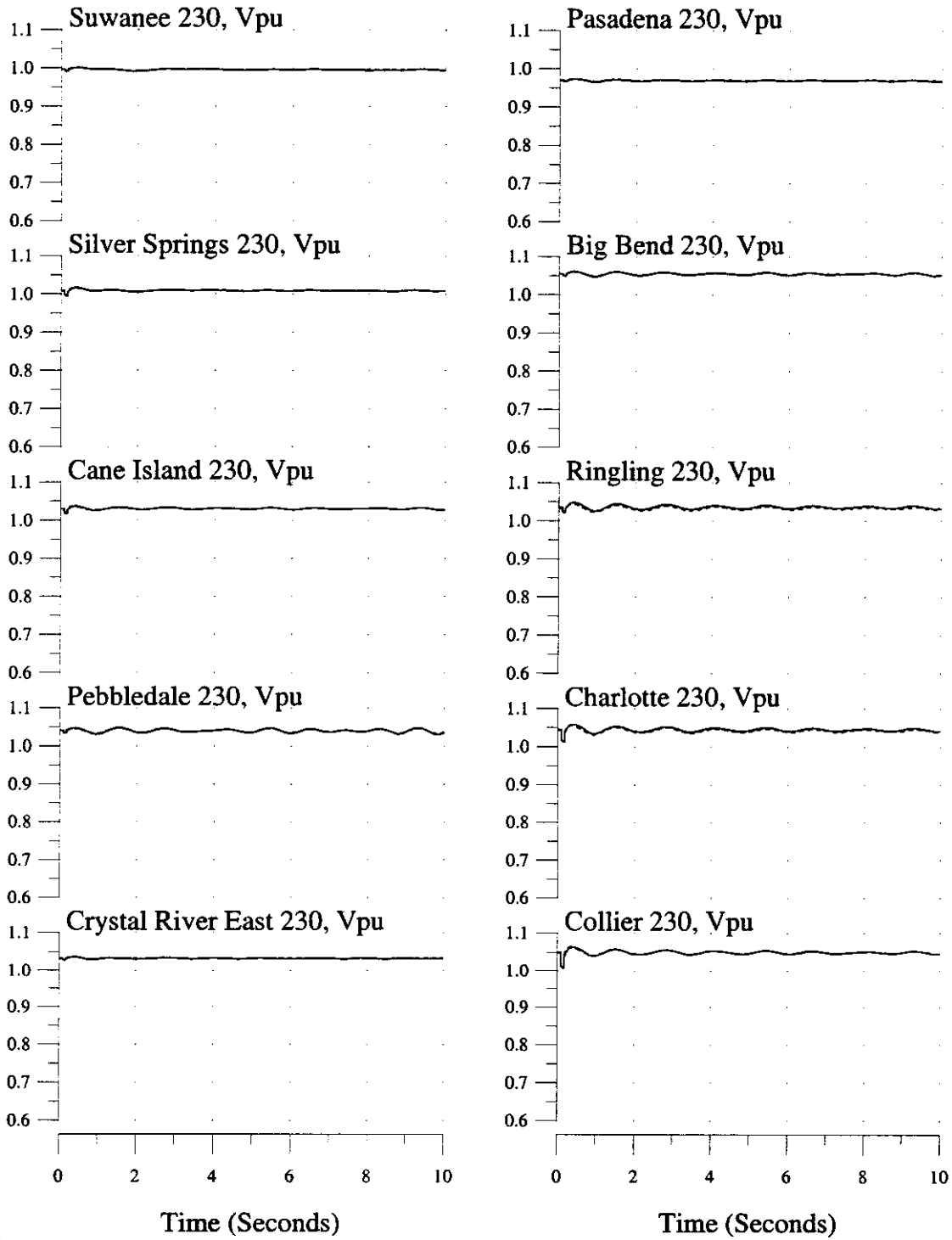

3-phase, 5-cycle Fault at Okeechobee 230kV Bus, Trip Okeechobee-Martin 230kV Line 2003 Summer System

Machine & Interface Variables: (—) With Okeechobee TEC Dispatch, (...) Without

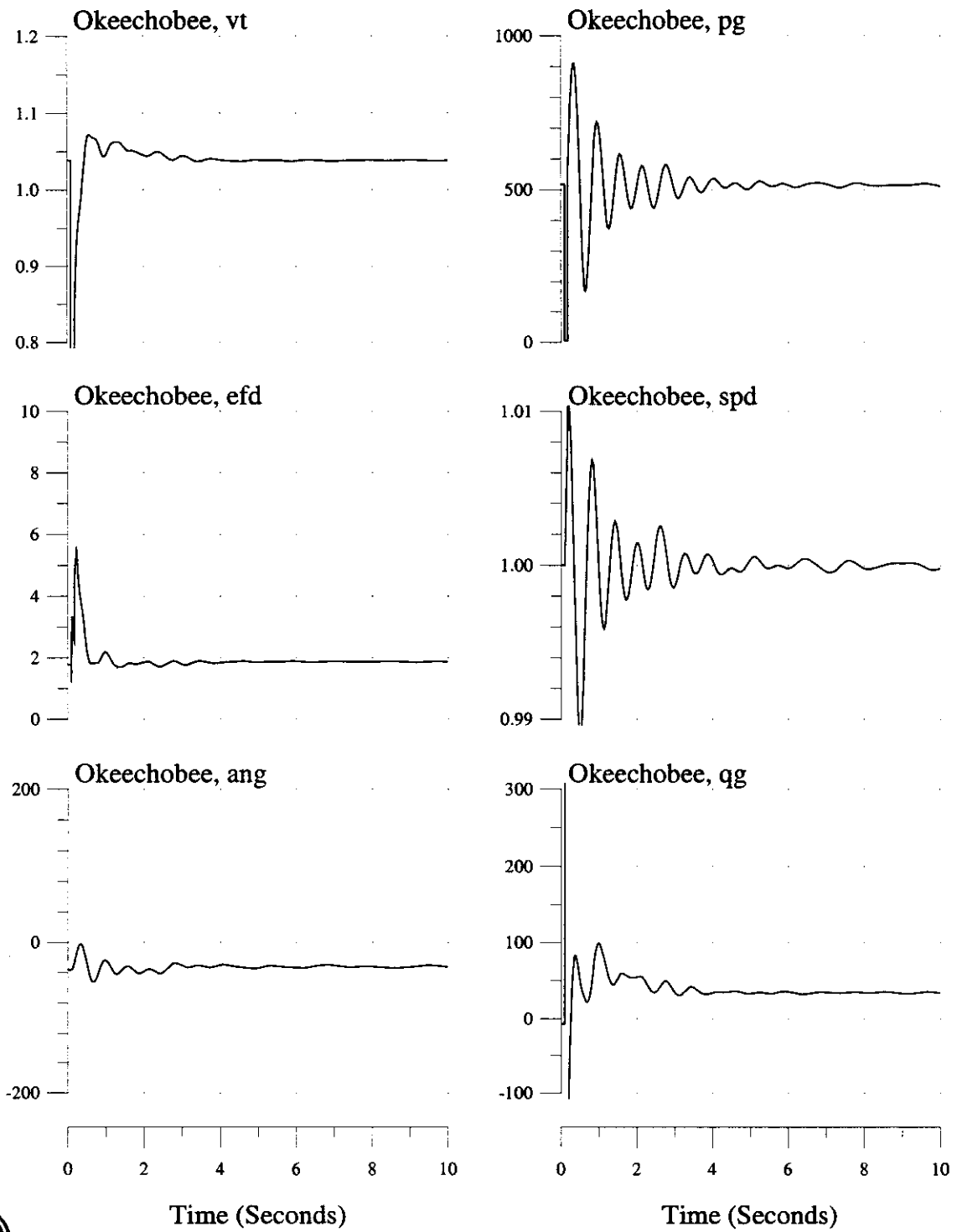

3-phase, 5-cycle Fault at Okeechobee 230kV Bus, Trip Okeechobee-Martin 230kV Line 2003 Summer System

Machine & Interface Variables: (—) With Okeechobee TEC Dispatch, (...) Without

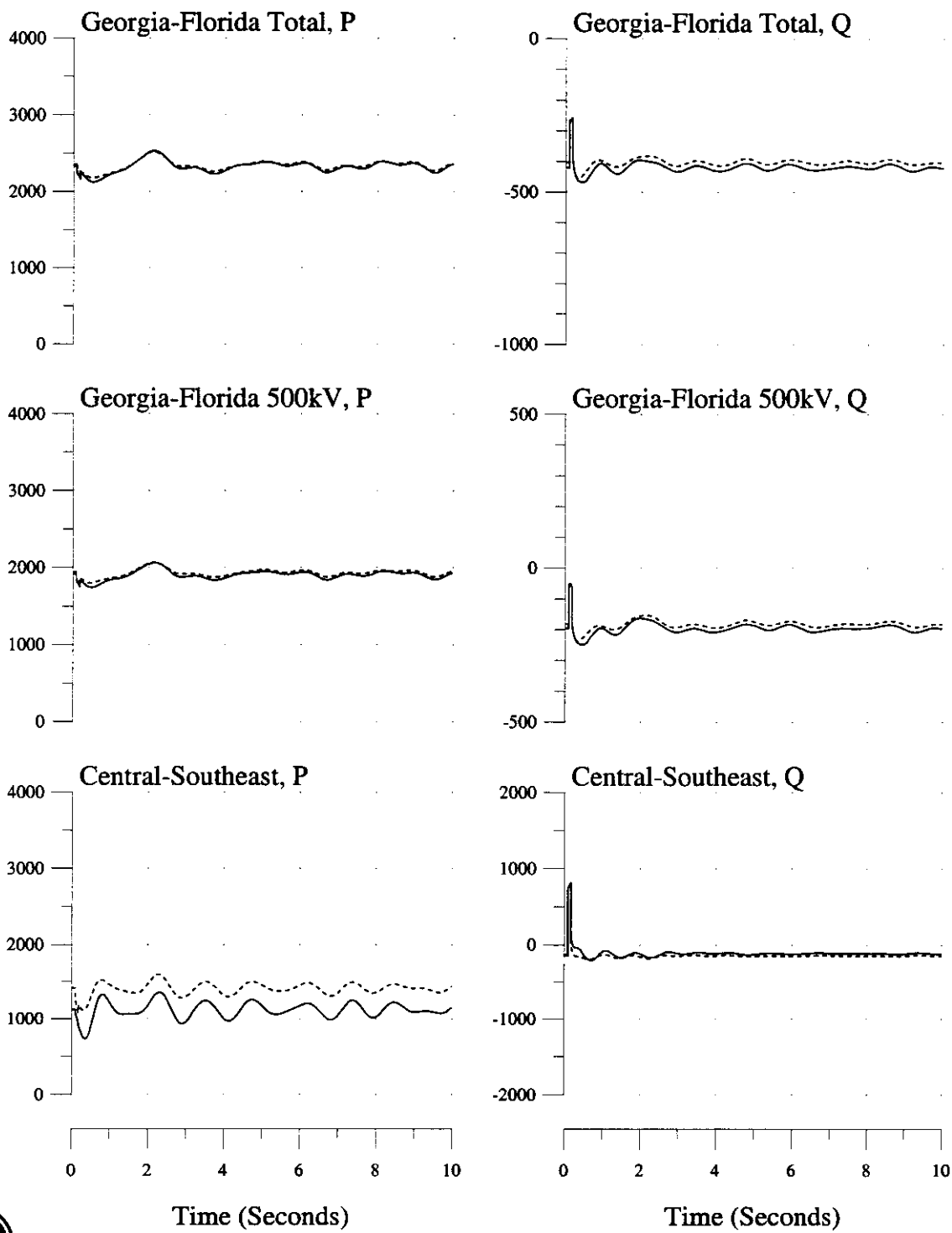

3-phase, 5-cycle Fault at Okeechobee 230kV Bus, Trip Okeechobee-Martin 230kV Line
2003 Summer System

Machine Variables: (—) With Okeechobee TEC Dispatch, (...) Without

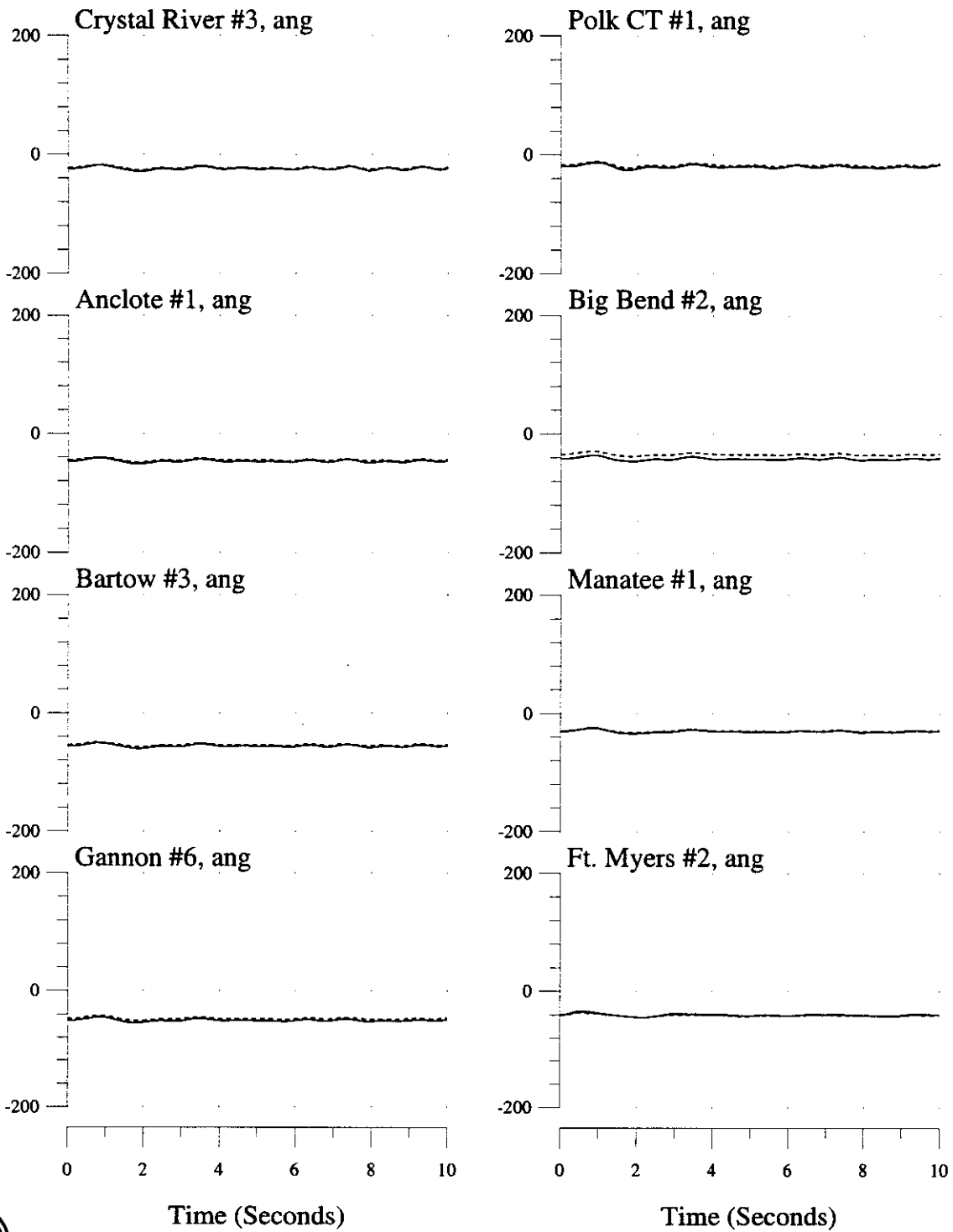

3-phase, 5-cycle Fault at Okeechobee 230kV Bus, Trip Okeechobee-Martin 230kV Line
 2003 Summer System

Machine Variables: (—) With Okeechobee TEC Dispatch, (...) Without

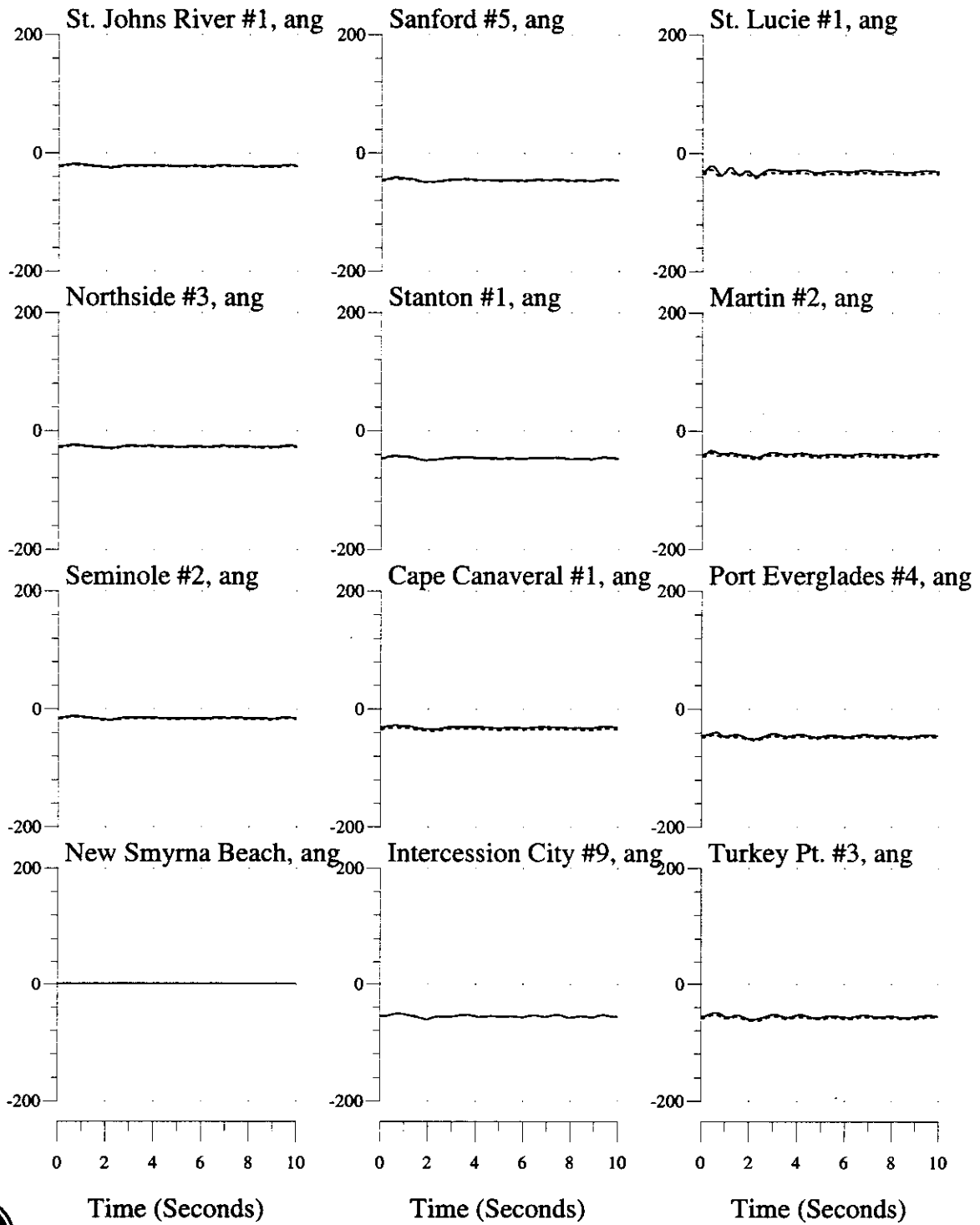

3-phase, 5-cycle Fault at Okeechobee 230kV Bus, Trip Okeechobee-Martin 230kV Line
 2003 Summer System

Bus Variables: (—) With Okeechobee TEC Dispatch, (...) Without

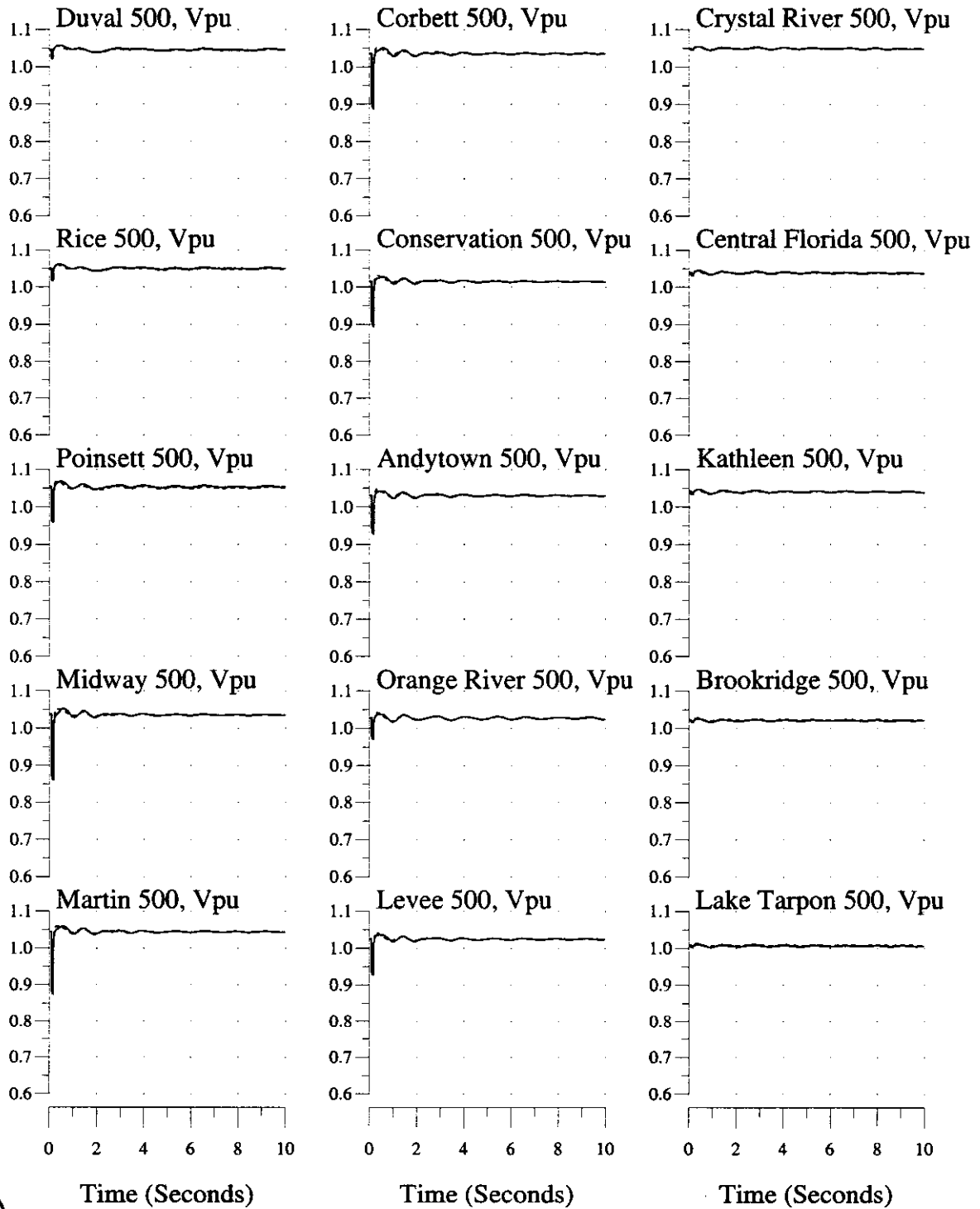

3-phase, 5-cycle Fault at Okeechobee 230kV Bus, Trip Okeechobee-Martin 230kV Line
2003 Summer System

Bus Variables: (—) With Okeechobee TEC Dispatch, (...) Without

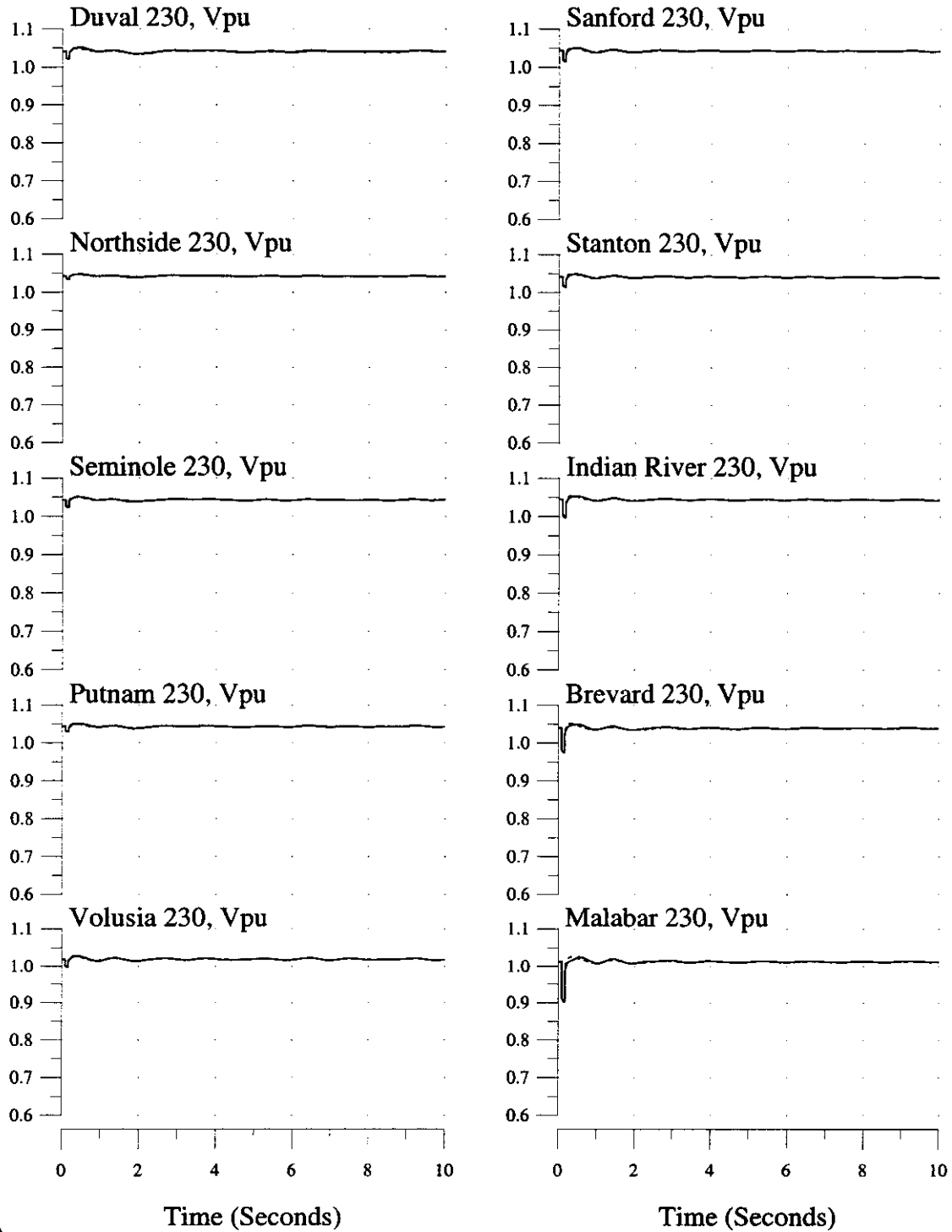

3-phase, 5-cycle Fault at Okeechobee 230kV Bus, Trip Okeechobee-Martin 230kV Line
2003 Summer System

Bus Variables: (___) With Okeechobee TEC Dispatch, (...) Without

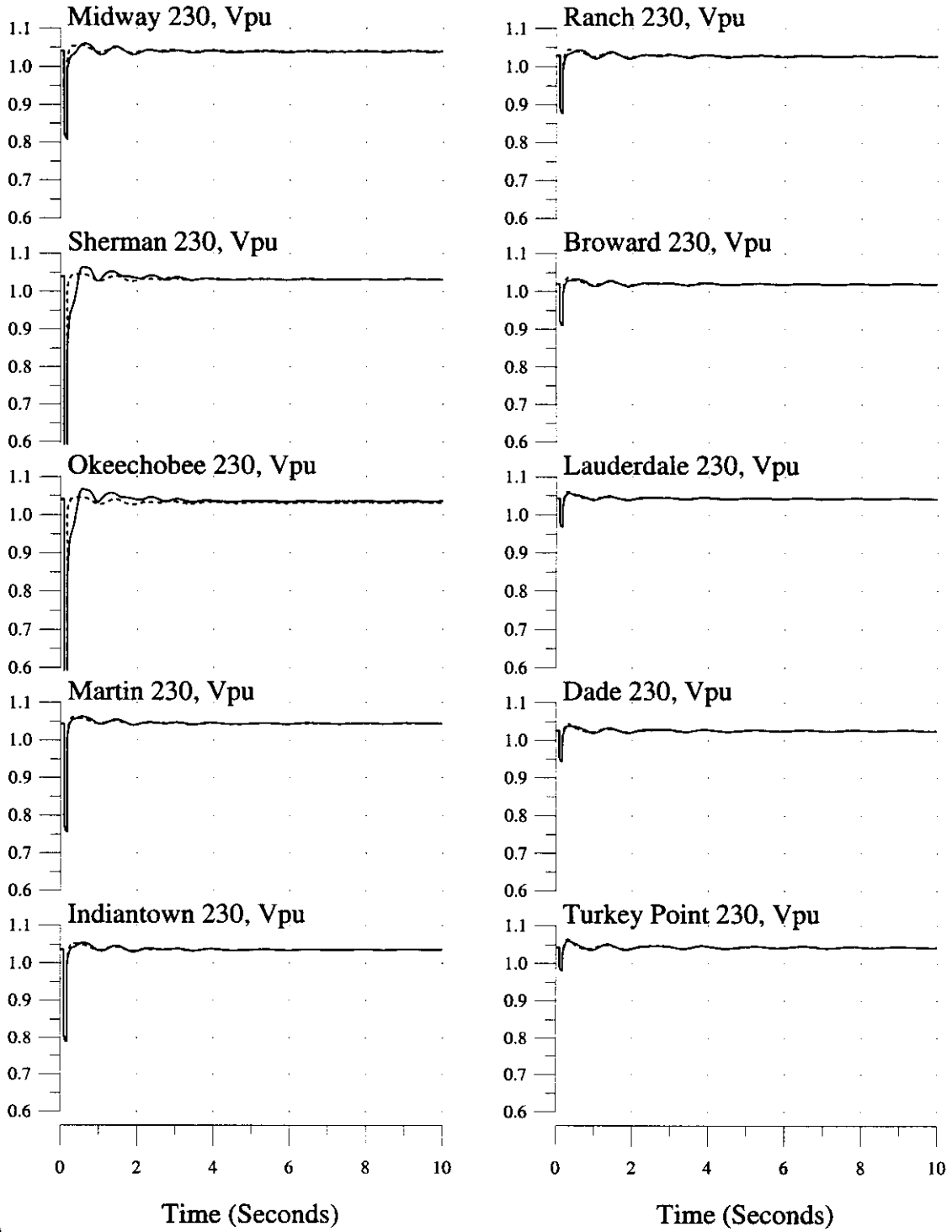

3-phase, 5-cycle Fault at Okeechobee 230kV Bus, Trip Okeechobee-Martin 230kV Line
2003 Summer System

Bus Variables: (—) With Okeechobee TEC Dispatch, (...) Without

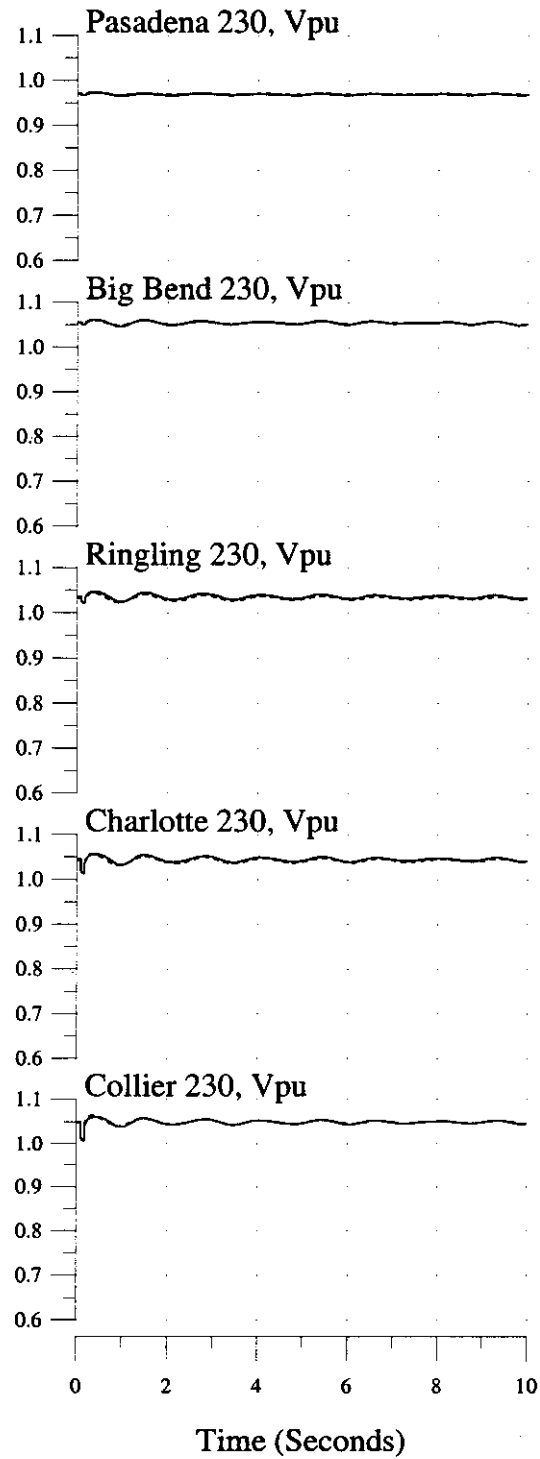
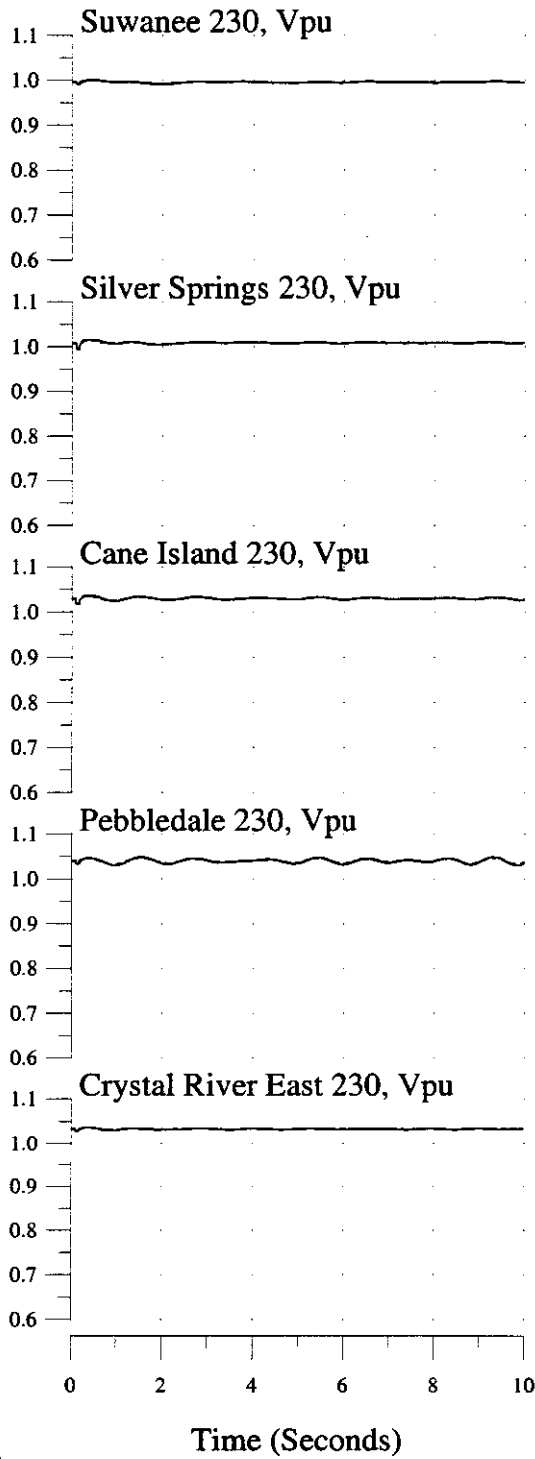

3-ph, 5-cy Fault at Martin 500kV Bus, Trip Martin #2 & GSU, TT Martin-Poinsett 500kV Line
2003 Summer System

Machine & Interface Variables: (—) With Okeechobee TEC Dispatch, (...) Without

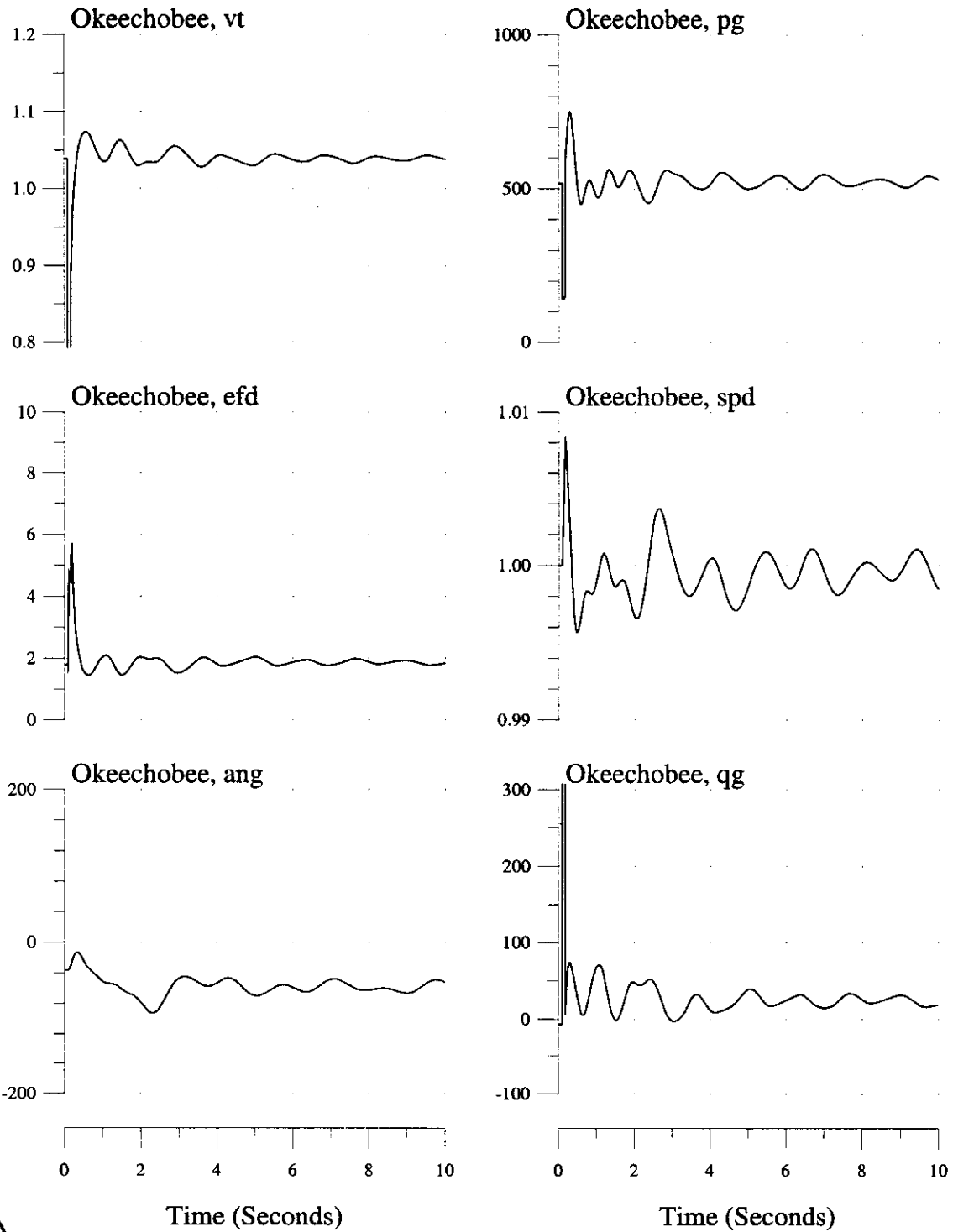

3-ph, 5-cy Fault at Martin 500kV Bus, Trip Martin #2 & GSU, TT Martin-Poinsett 500kV Line
 2003 Summer System

Machine & Interface Variables: (—) With Okeechobee TEC Dispatch, (...) Without

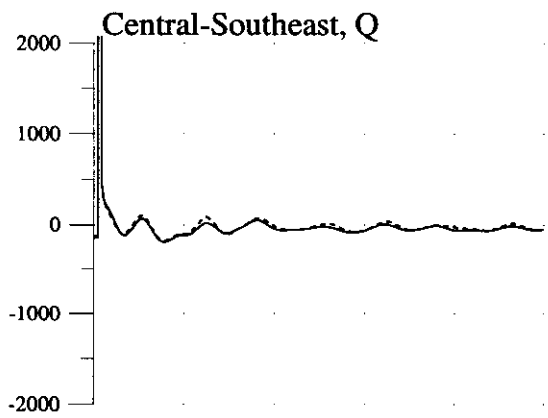
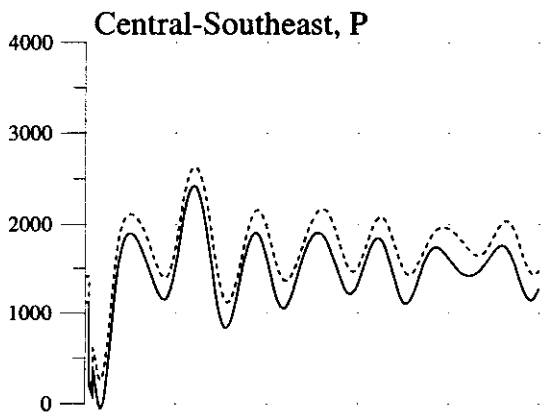
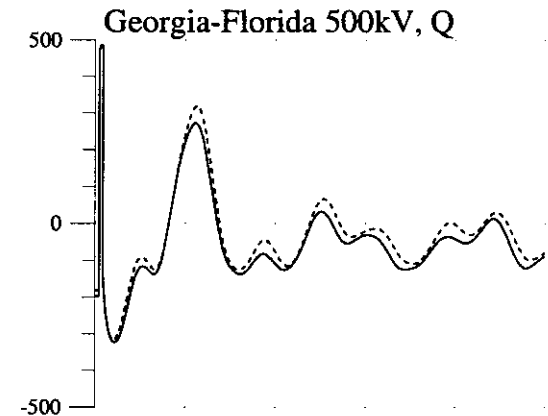
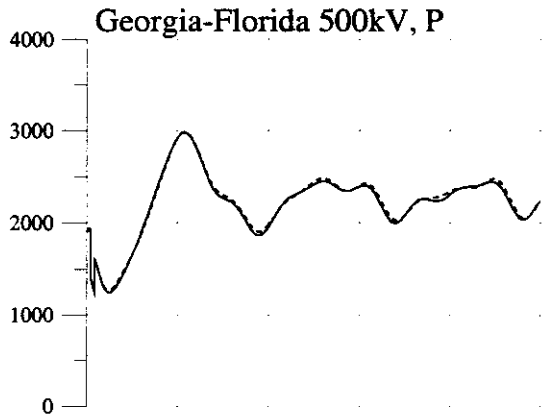
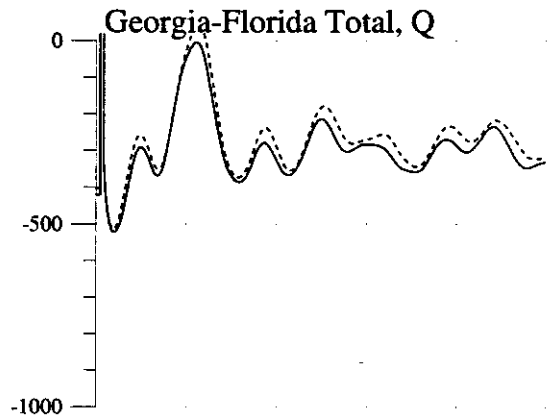
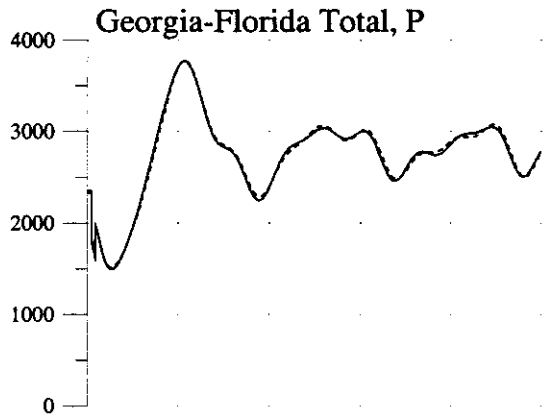

Time (Seconds)

Time (Seconds)



3-ph, 5-cy Fault at Martin 500kV Bus, Trip Martin #2 & GSU, TT Martin-Poinsett 500kV Line
2003 Summer System

Machine Variables: (___) With Okeechobee TEC Dispatch, (...) Without

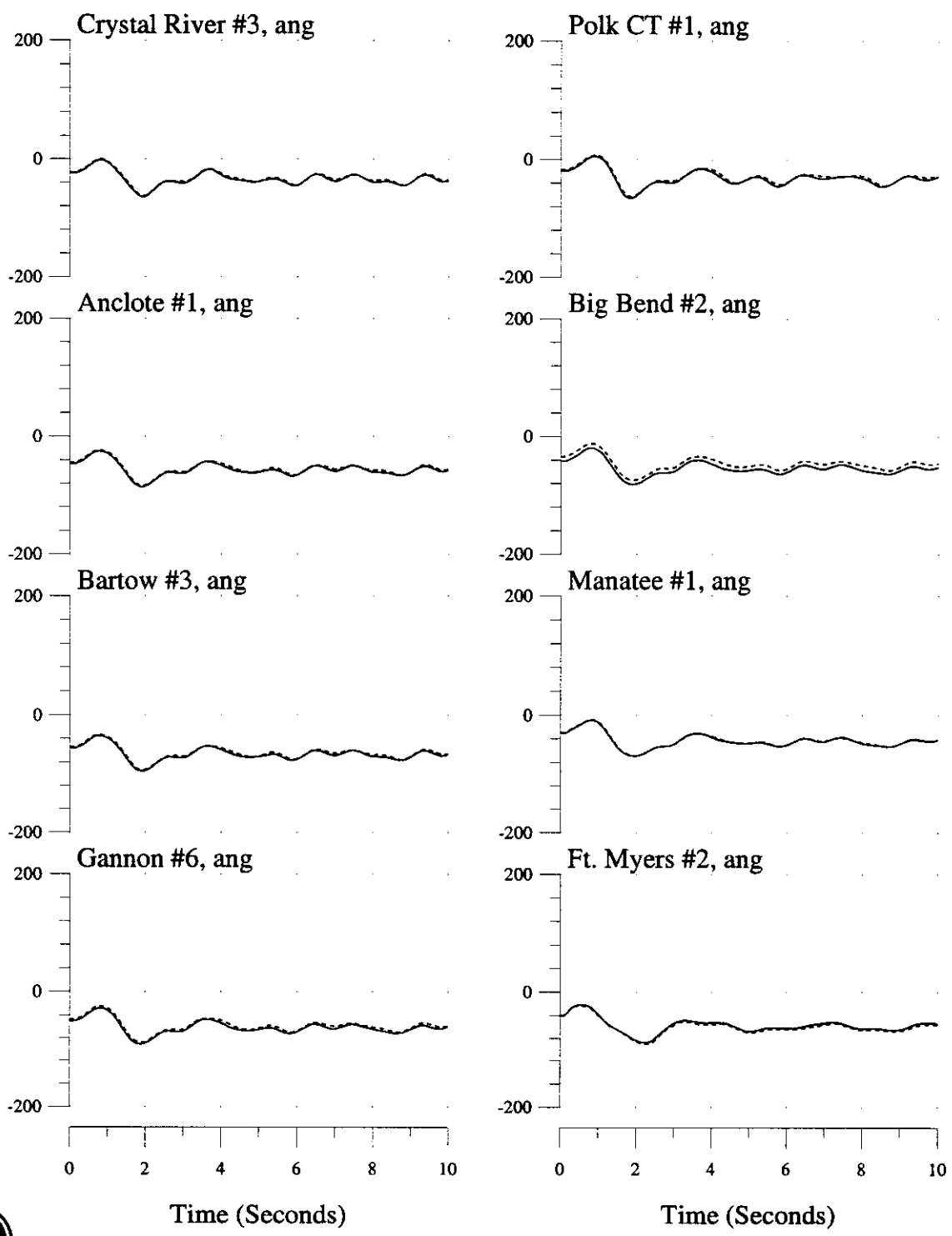

3-ph, 5-cy Fault at Martin 500kV Bus, Trip Martin #2 & GSU, TT Martin-Poinsett 500kV Line
 2003 Summer System

Machine Variables: (___) With Okeechobee TEC Dispatch, (...) Without

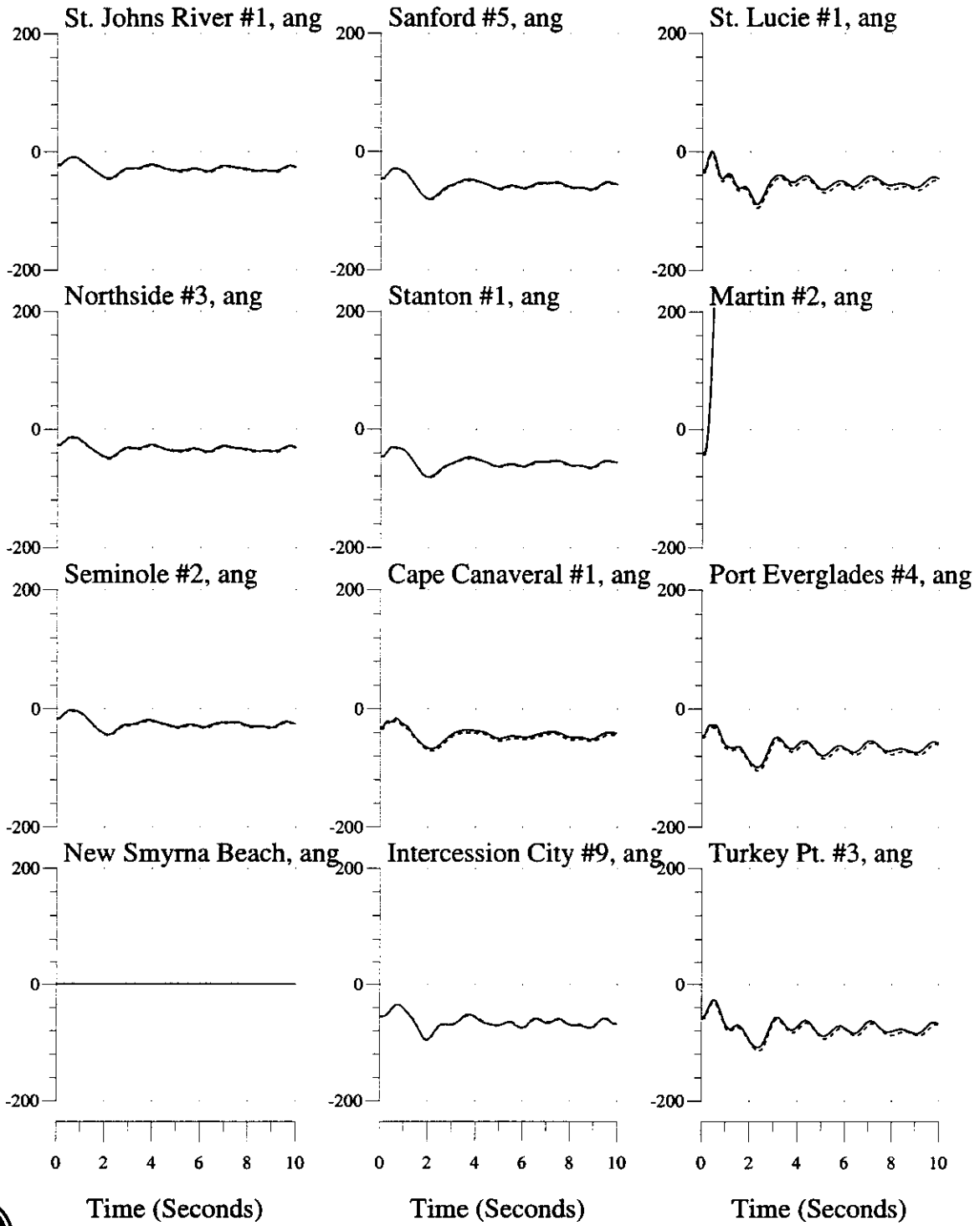

3-ph, 5-cy Fault at Martin 500kV Bus, Trip Martin #2 & GSU, TT Martin-Poinsett 500kV Line
 2003 Summer System

Bus Variables: (—) With Okeechobee TEC Dispatch, (...) Without

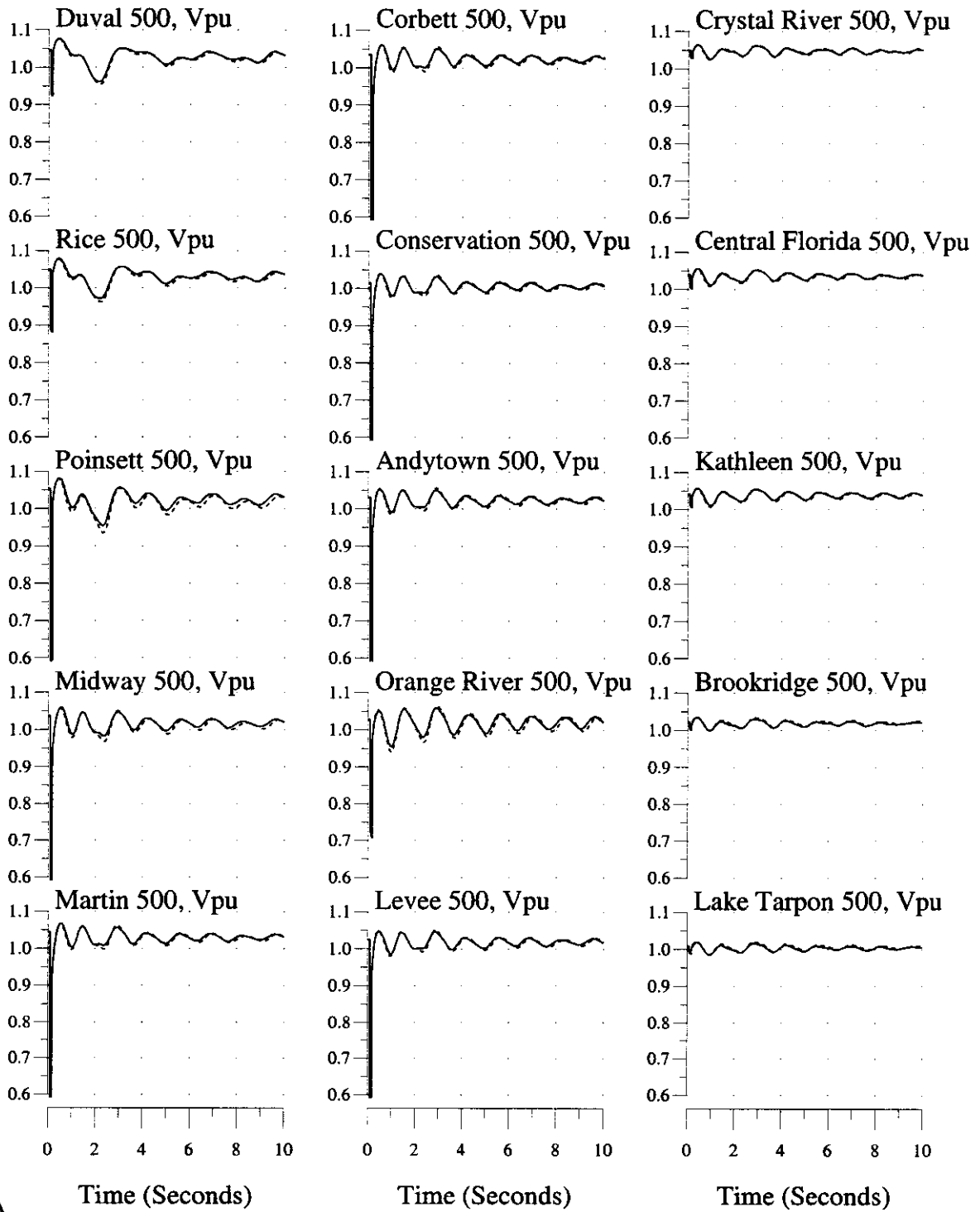

3-ph, 5-cy Fault at Martin 500kV Bus, Trip Martin #2 & GSU, TT Martin-Poinsett 500kV Line
2003 Summer System

Bus Variables: (—) With Okeechobee TEC Dispatch, (...) Without

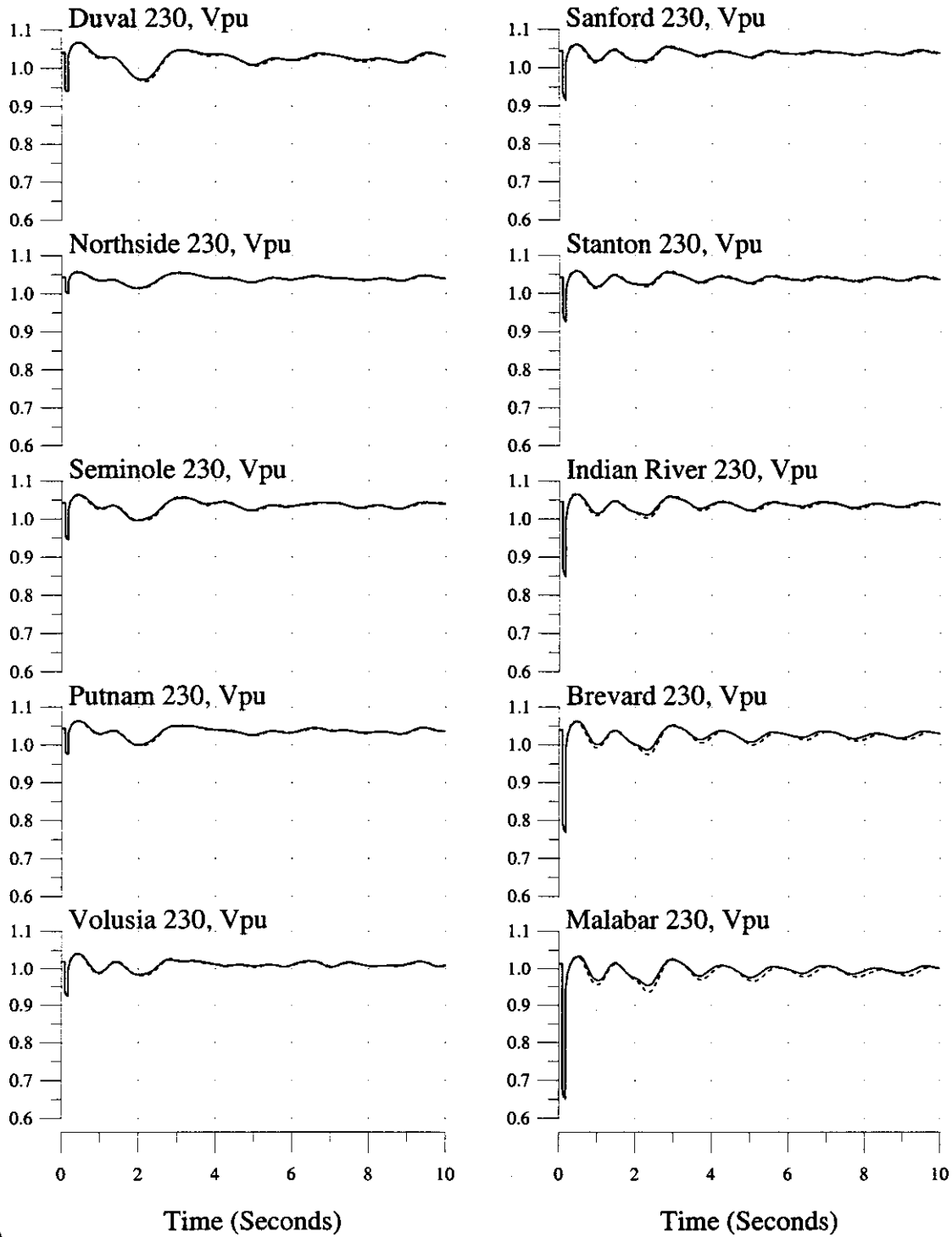

3-ph, 5-cy Fault at Martin 500kV Bus, Trip Martin #2 & GSU, TT Martin-Poinsett 500kV Line
2003 Summer System

Bus Variables: (—) With Okeechobee TEC Dispatch, (...) Without

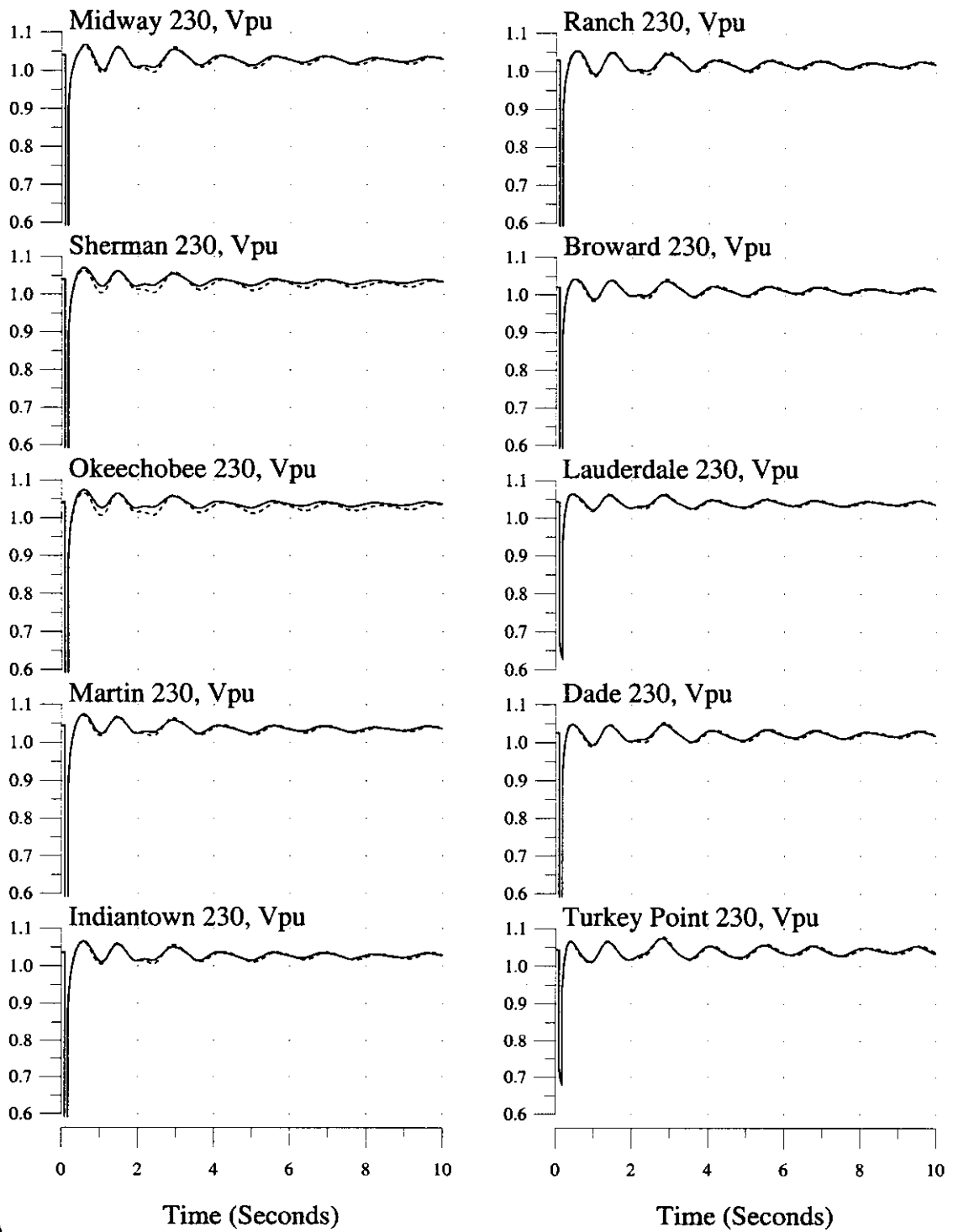

3-ph, 5-cy Fault at Martin 500kV Bus, Trip Martin #2 & GSU, TT Martin-Poinsett 500kV Line
2003 Summer System

Bus Variables: (—) With Okeechobee TEC Dispatch, (...) Without

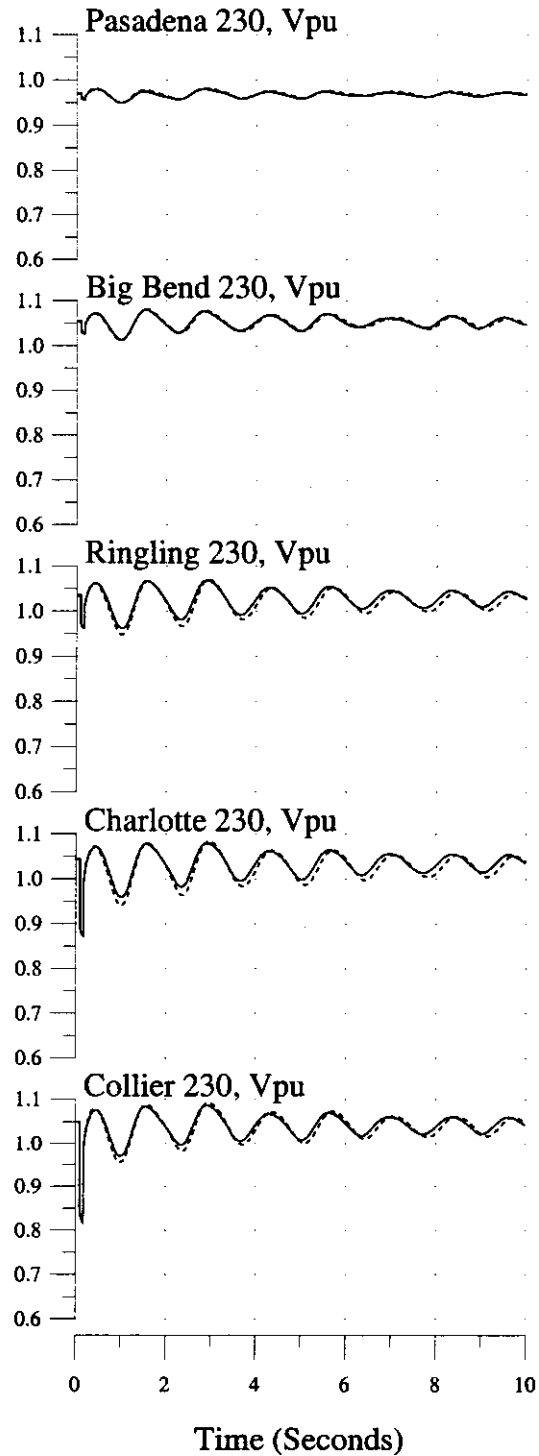
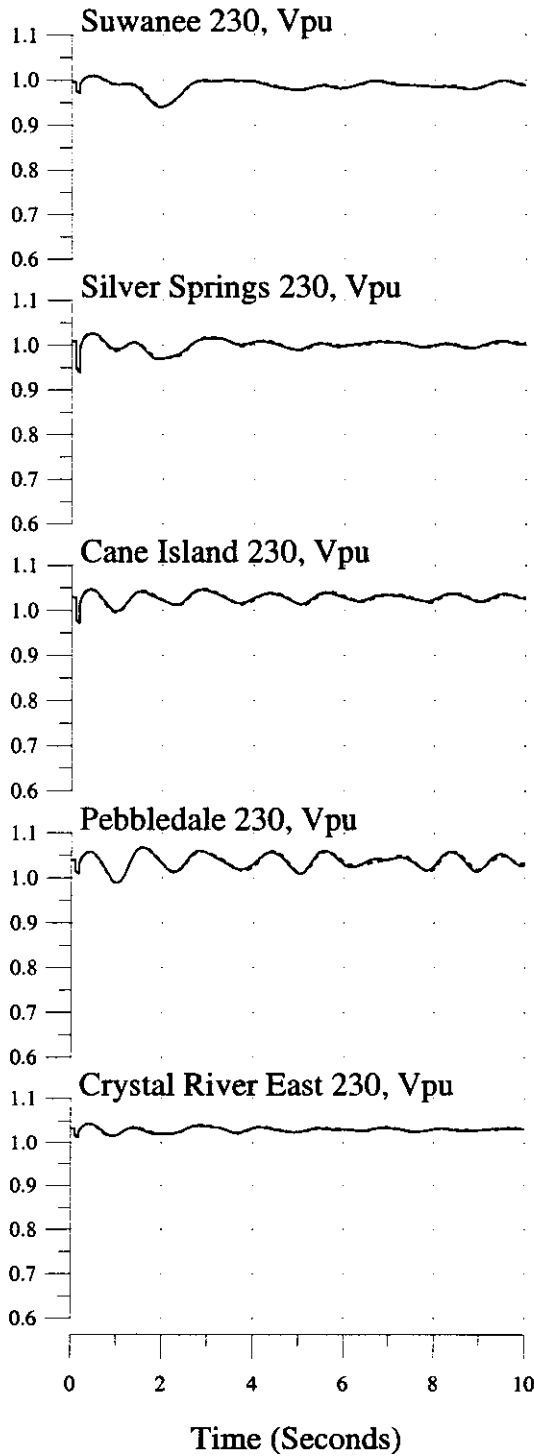

3-ph Fault at Turkey Pt 230kV Bus, Trip TP #3 & GSU @5-cy, Trip TP-Galloway 230kV Line @12cy
2003 Summer System

Machine & Interface Variables: (—) With Okeechobee TEC Dispatch, (...) Without

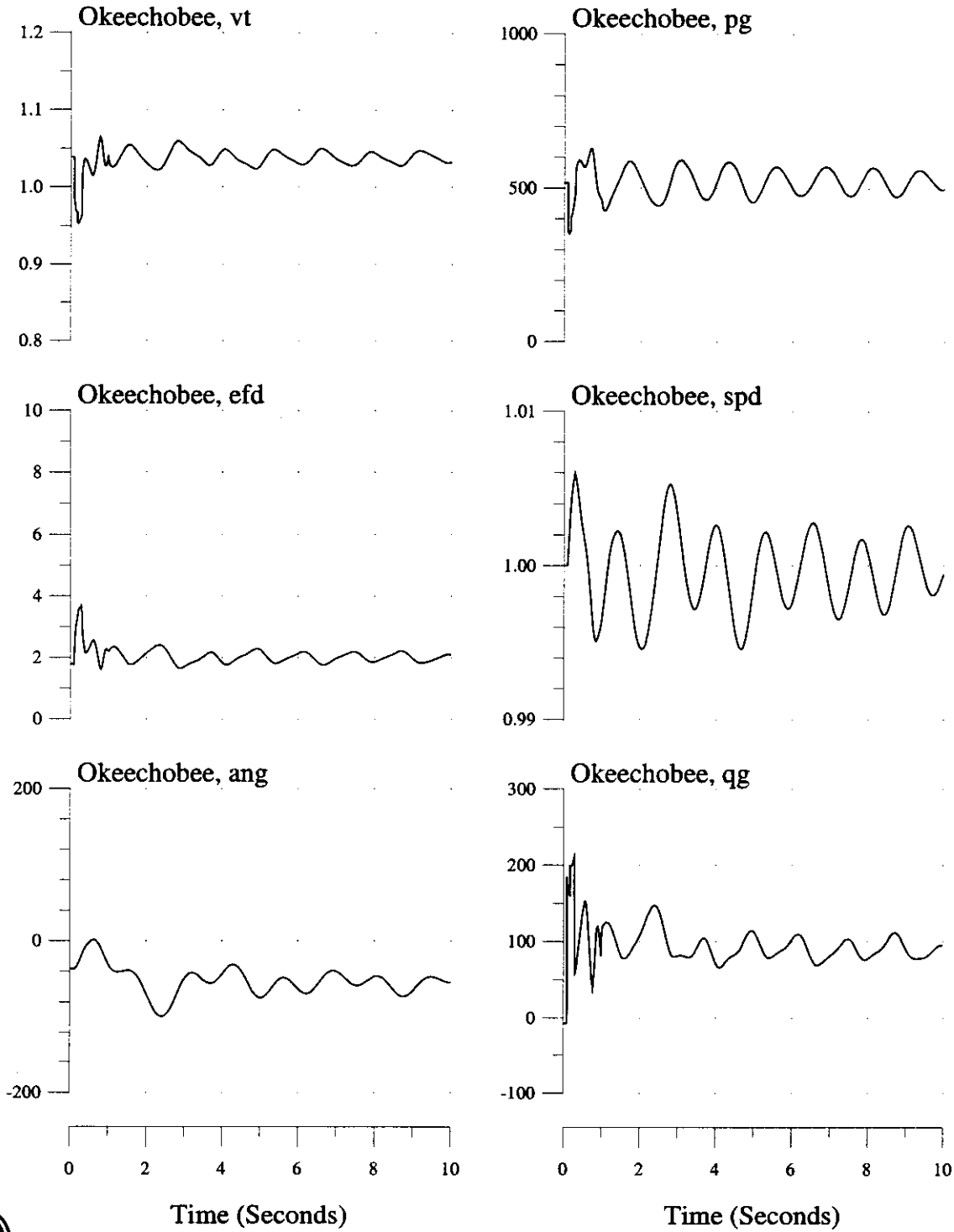

3-ph Fault at Turkey Pt 230kV Bus, Trip TP #3 & GSU @5-cy, Trip TP-Galloway 230kV Line @12cy
2003 Summer System

Machine & Interface Variables: (—) With Okeechobee TEC Dispatch, (...) Without

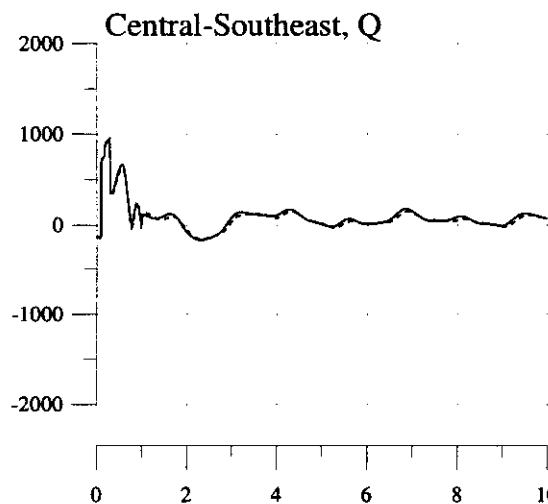
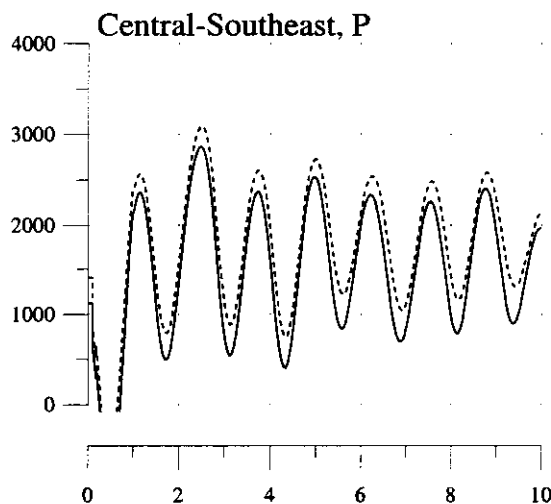
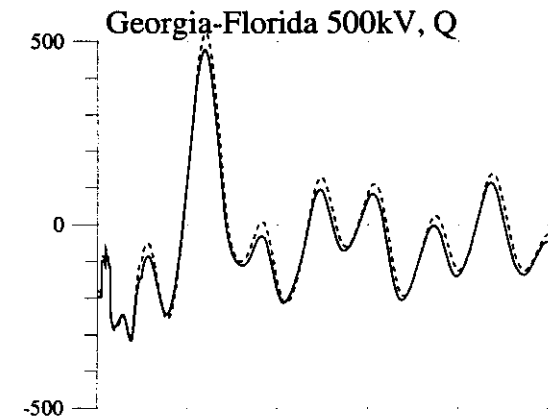
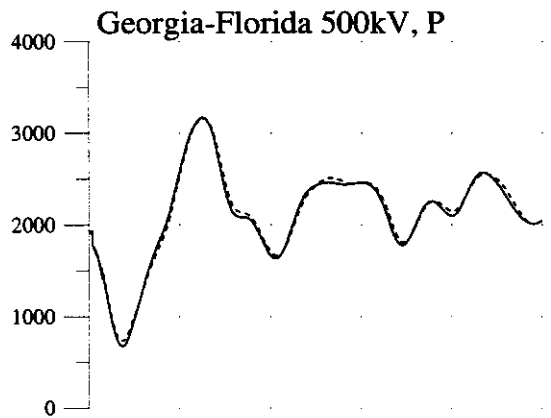
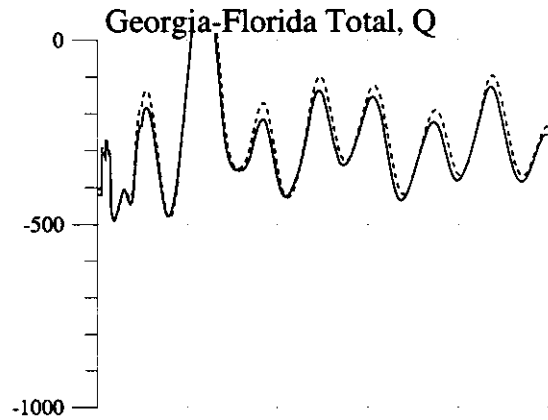
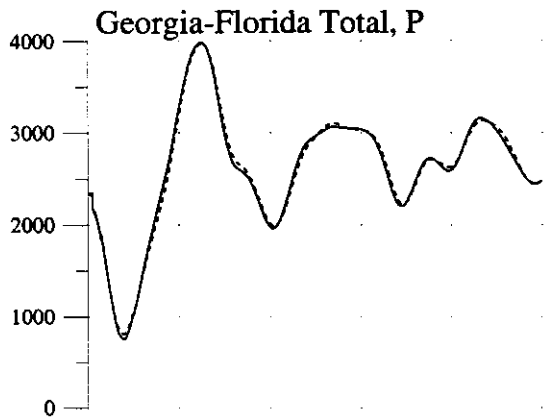

Time (Seconds)

Time (Seconds)



3-ph Fault at Turkey Pt 230kV Bus, Trip TP #3 & GSU @5-cy, Trip TP-Galloway 230kV Line @12cy
2003 Summer System

Machine Variables: (—) With Okeechobee TEC Dispatch, (...) Without

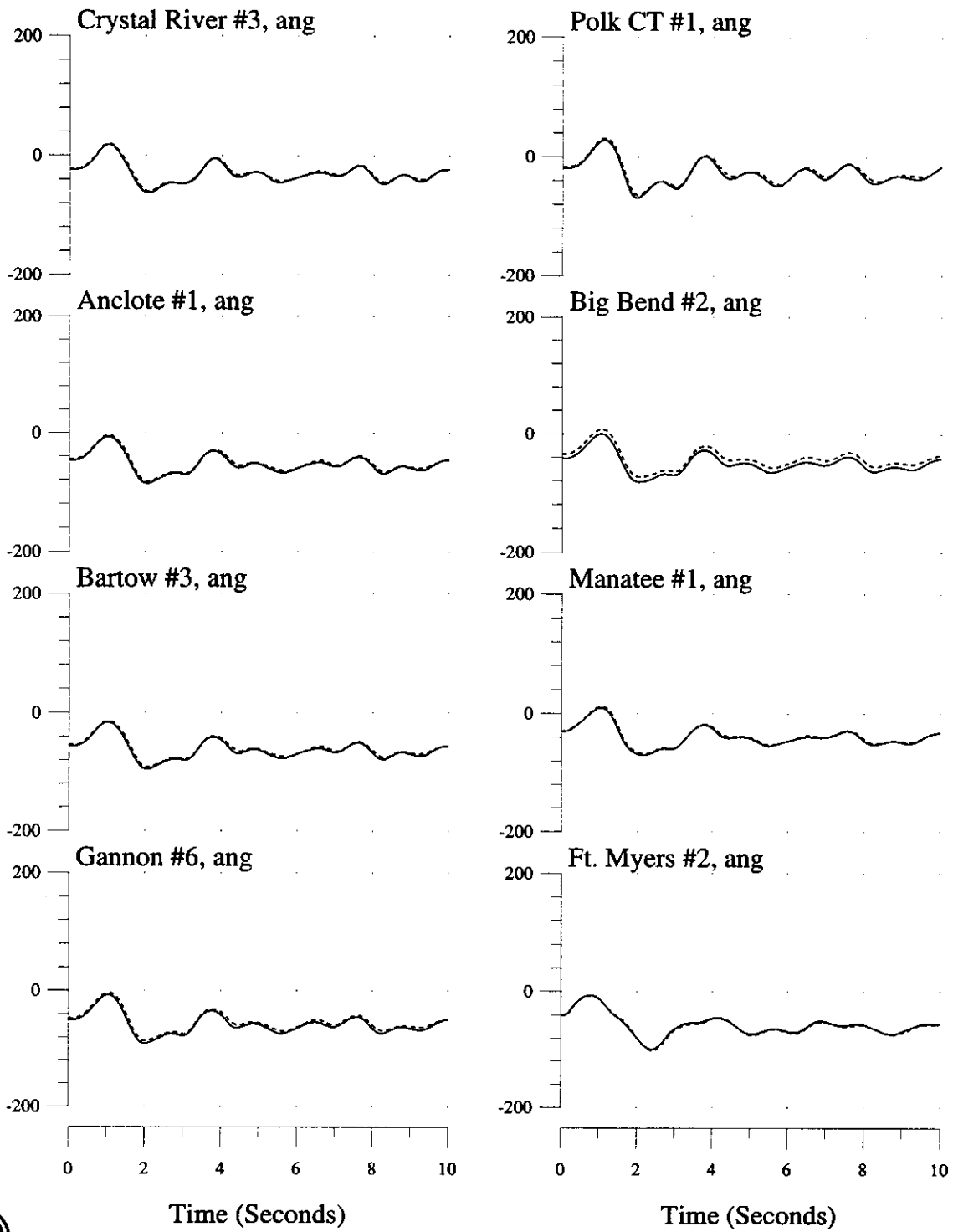

3-ph Fault at Turkey Pt 230kV Bus, Trip TP #3 & GSU @5-cy, Trip TP-Galloway 230kV Line @12cy
 2003 Summer System

Machine Variables: (—) With Okeechobee TEC Dispatch, (...) Without

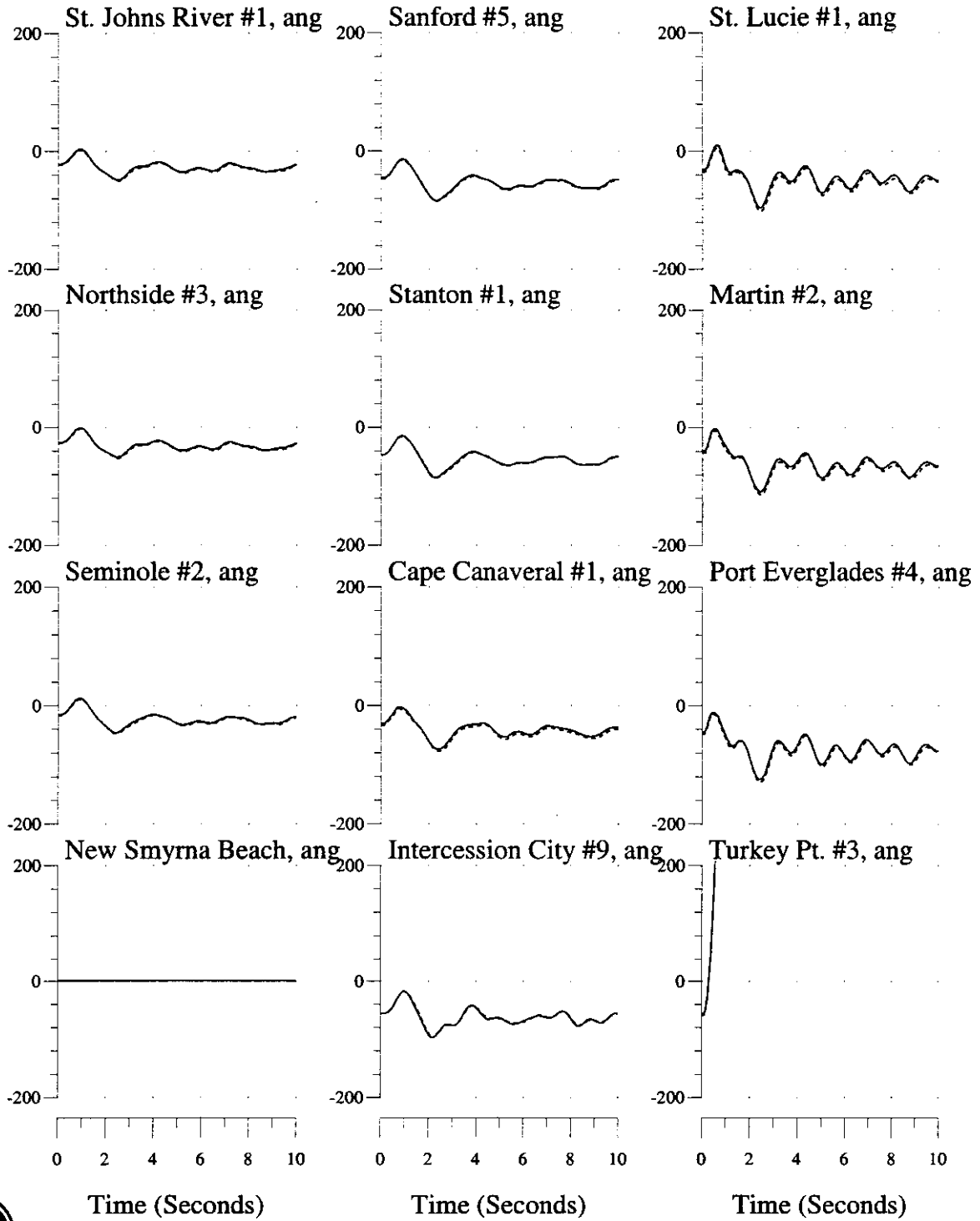

3-ph Fault at Turkey Pt 230kV Bus, Trip TP #3 & GSU @5-cy, Trip TP-Galloway 230kV Line @12cy
 2003 Summer System

Bus Variables: (—) With Okeechobee TEC Dispatch, (...) Without

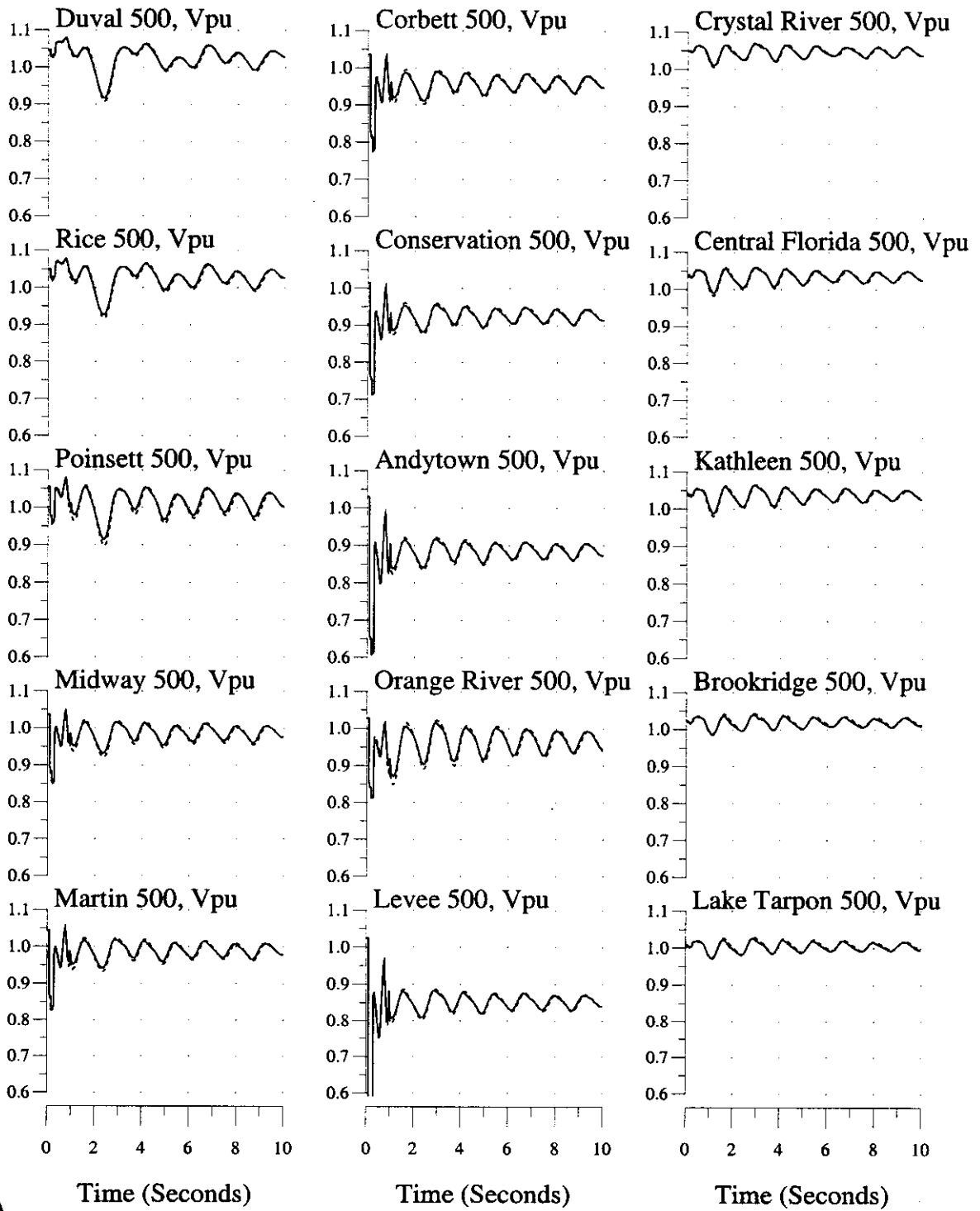

3-ph Fault at Turkey Pt 230kV Bus, Trip TP #3 & GSU @5-cy, Trip TP-Galloway 230kV Line @12cy
2003 Summer System

Bus Variables: (—) With Okeechobee TEC Dispatch, (...) Without

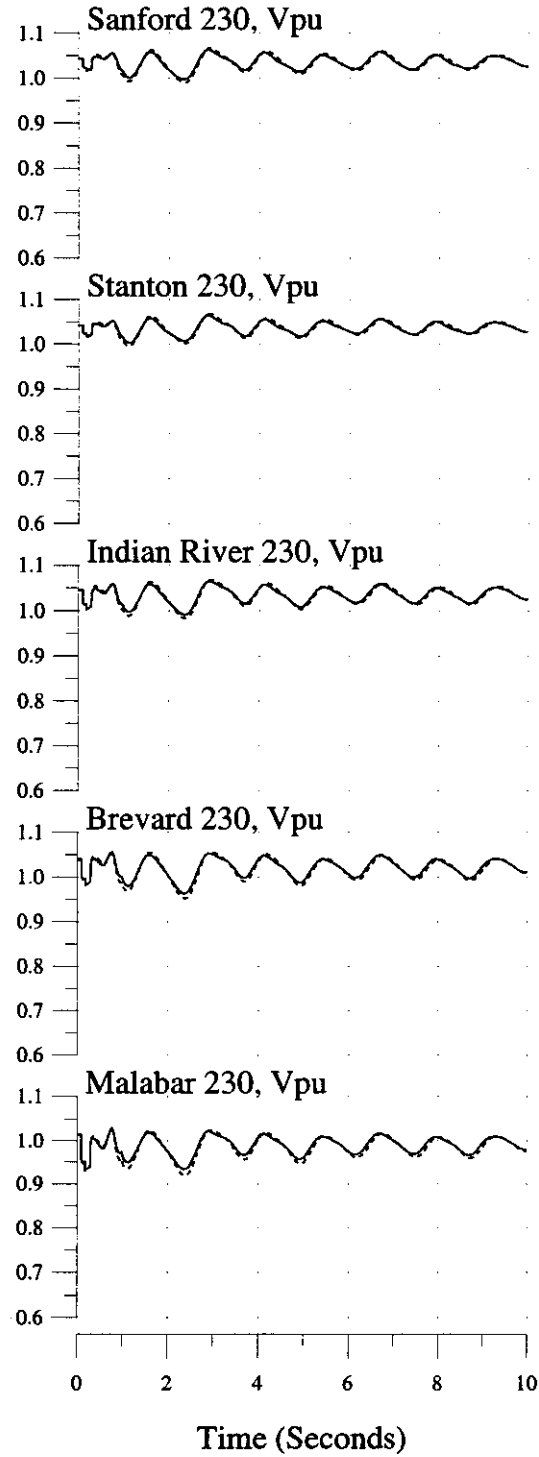
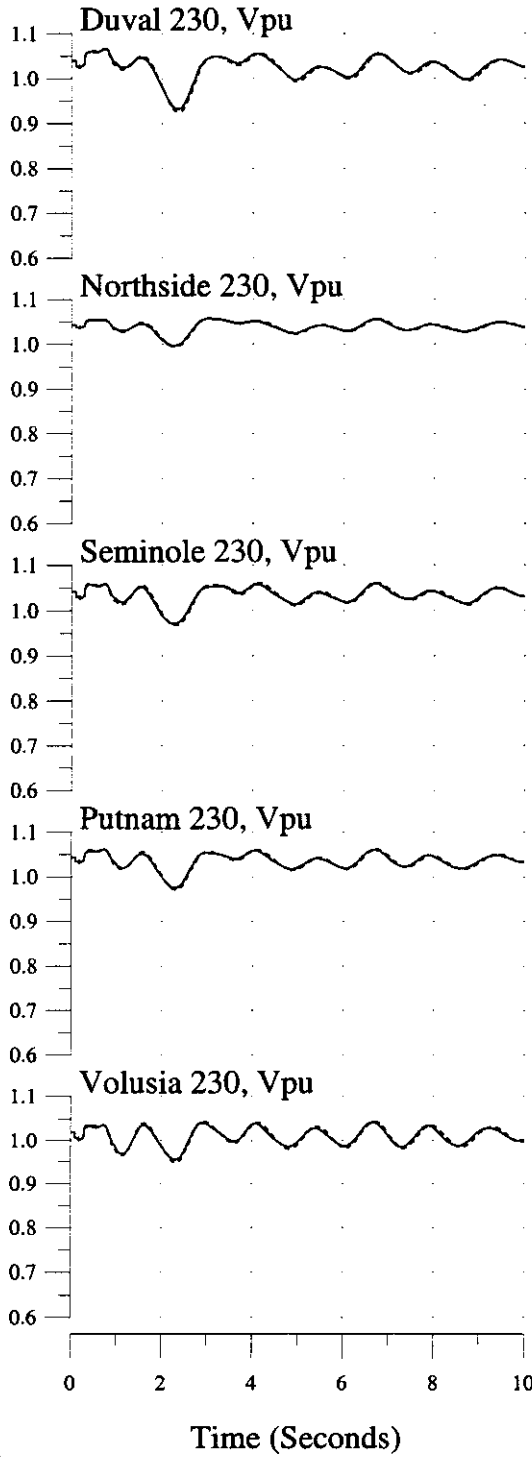

3-ph Fault at Turkey Pt 230kV Bus, Trip TP #3 & GSU @5-cy, Trip TP-Galloway 230kV Line @12cy
2003 Summer System

Bus Variables: (—) With Okeechobee TEC Dispatch, (...) Without

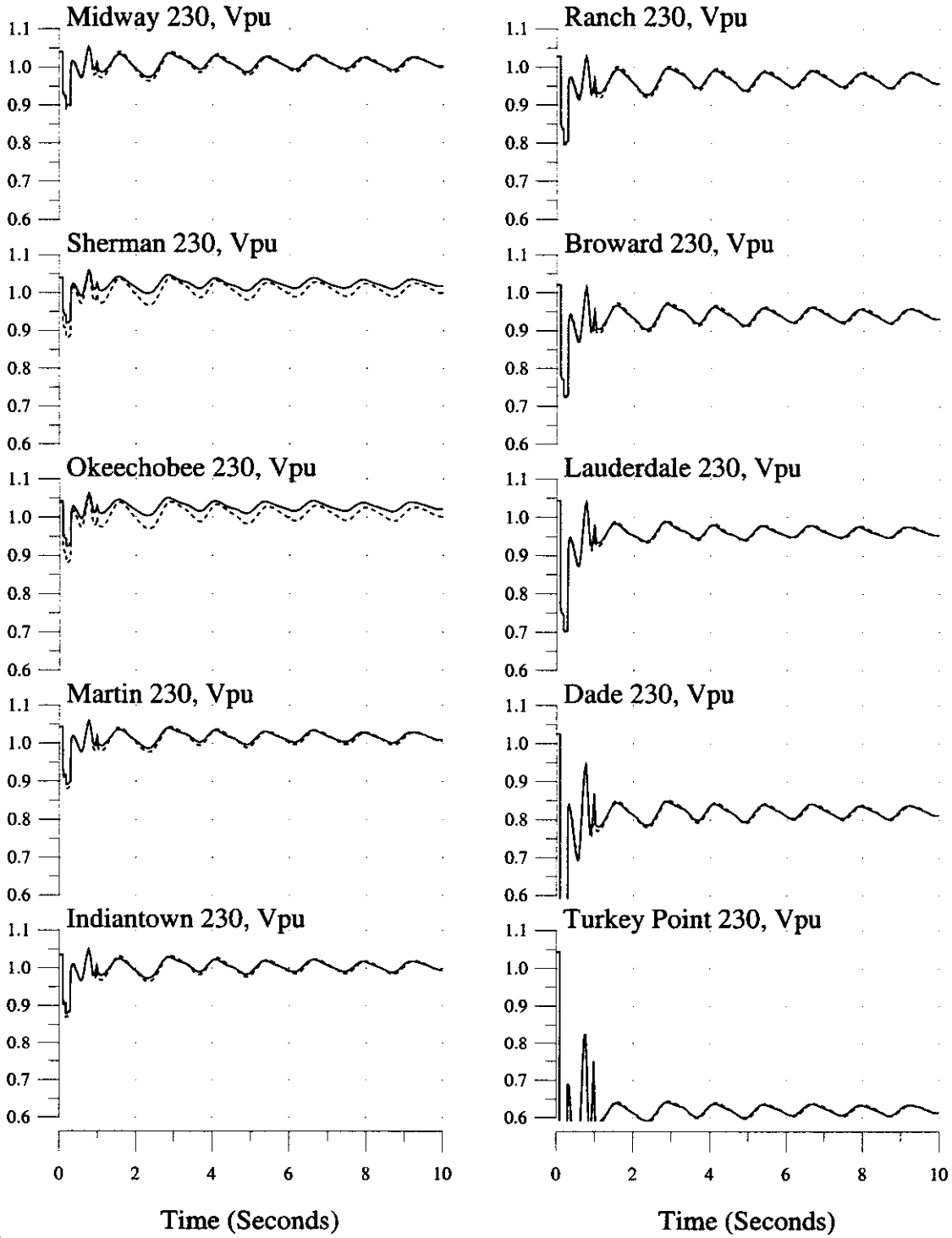

3-ph Fault at Turkey Pt 230kV Bus, Trip TP #3 & GSU @5-cy, Trip TP-Galloway 230kV Line @12cy
2003 Summer System

Bus Variables: (—) With Okeechobee TEC Dispatch, (...) Without

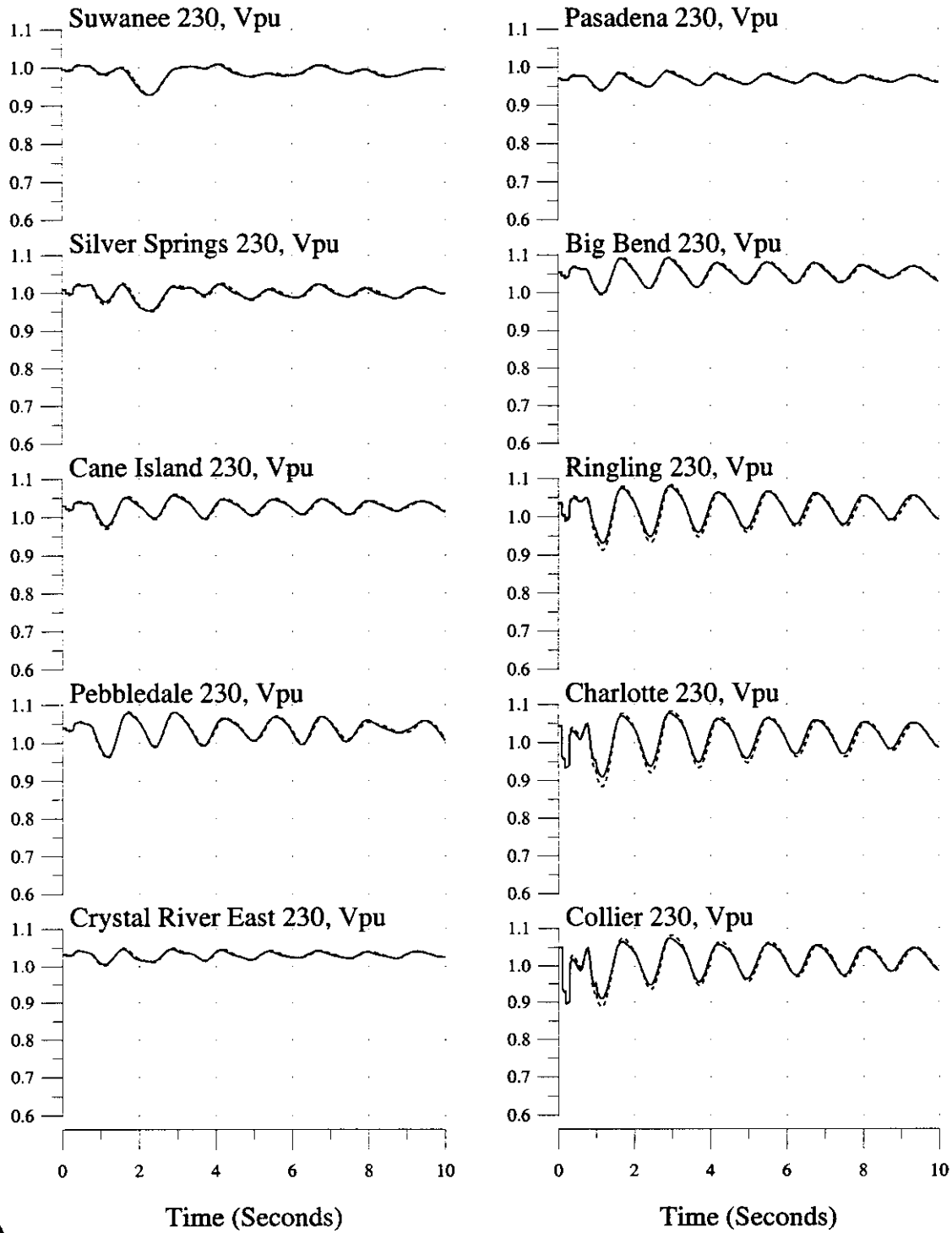

3-phase, 5-cycle Fault at St. Lucie 230kV Bus, Trip St. Lucie #1 & GSU
2003 Summer System

Machine & Interface Variables: (—) With Okeechobee JEA Dispatch, (...) Without

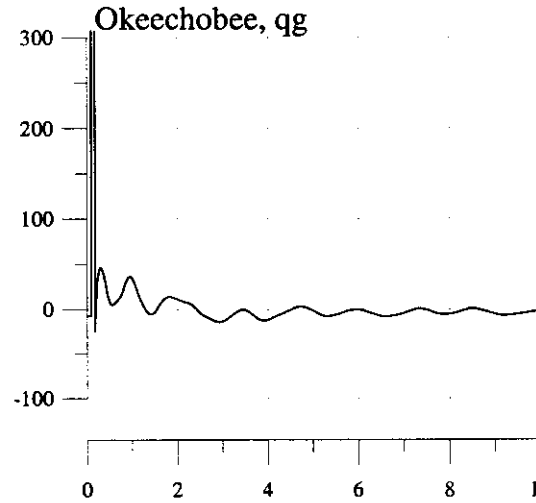
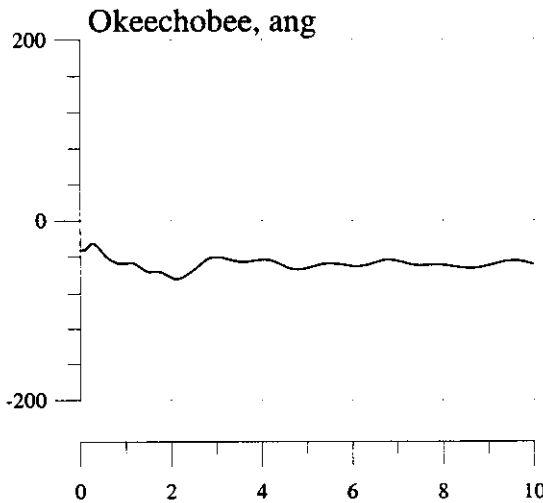
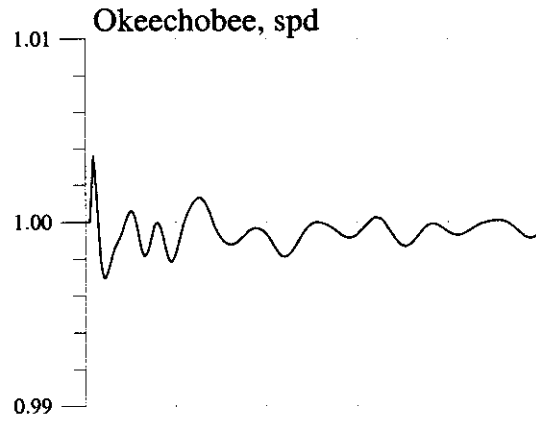
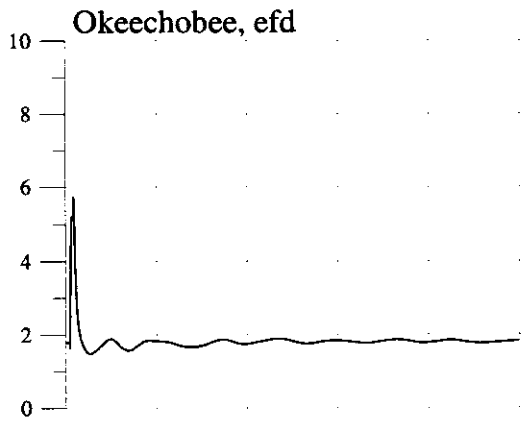
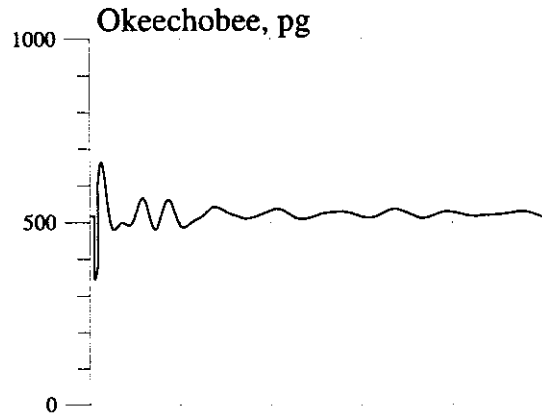
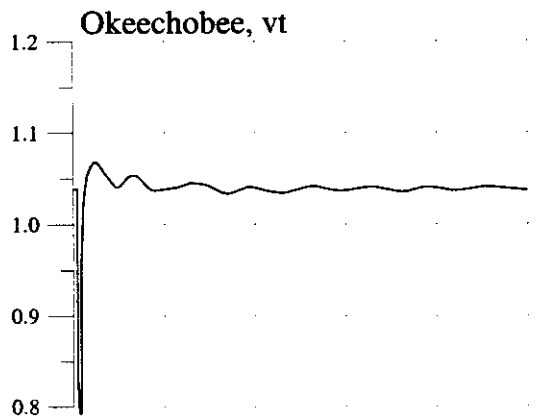

Time (Seconds)

Time (Seconds)



3-phase, 5-cycle Fault at St. Lucie 230kV Bus, Trip St. Lucie #1 & GSU
 2003 Summer System
 Machine & Interface Variables: (—) With Okeechobee JEA Dispatch, (...) Without

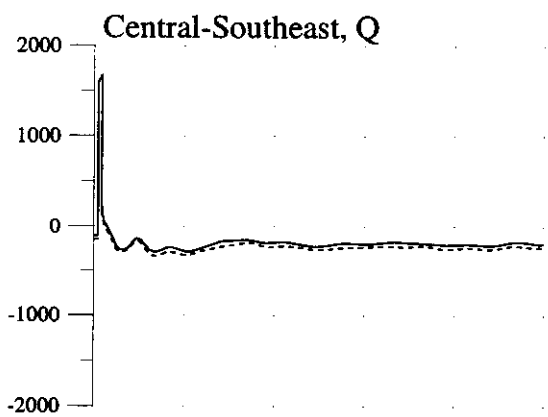
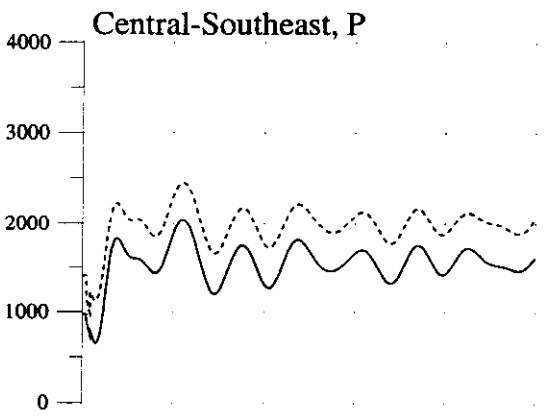
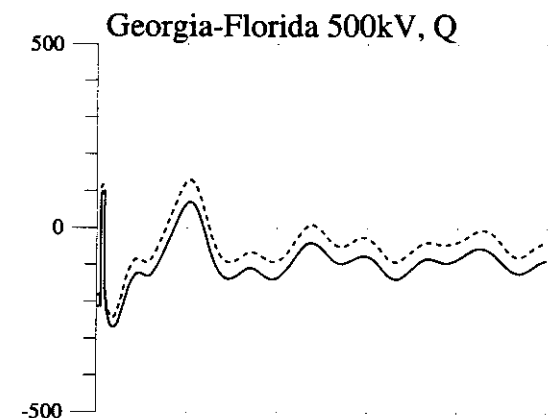
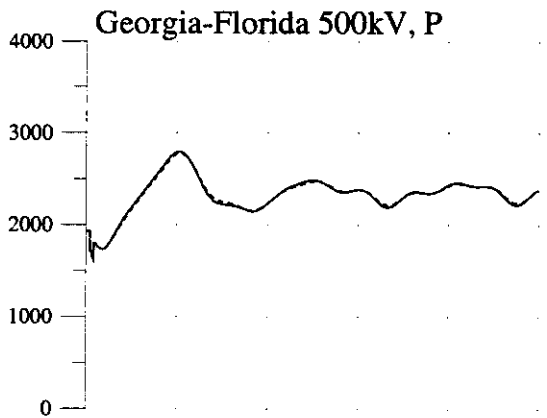
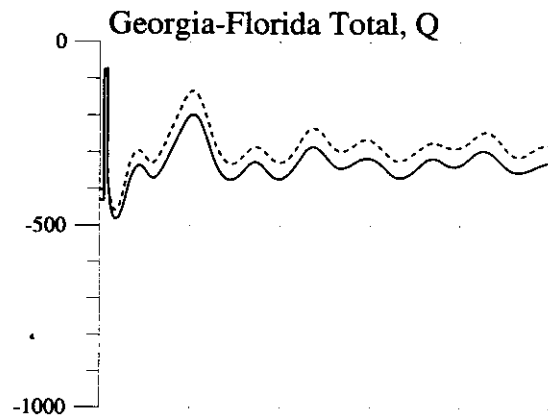
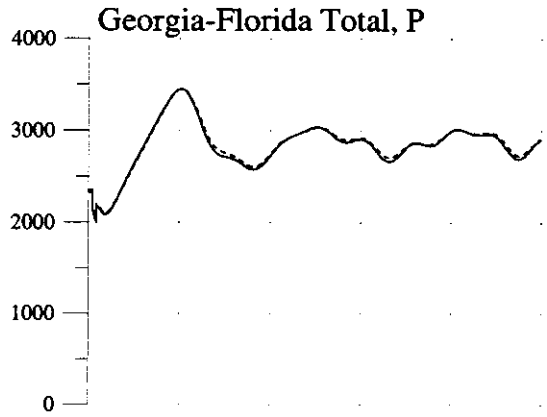

Time (Seconds)

Time (Seconds)



3-phase, 5-cycle Fault at St. Lucie 230kV Bus, Trip St. Lucie #1 & GSU
2003 Summer System

Machine Variables: (—) With Okeechobee JEA Dispatch, (...) Without

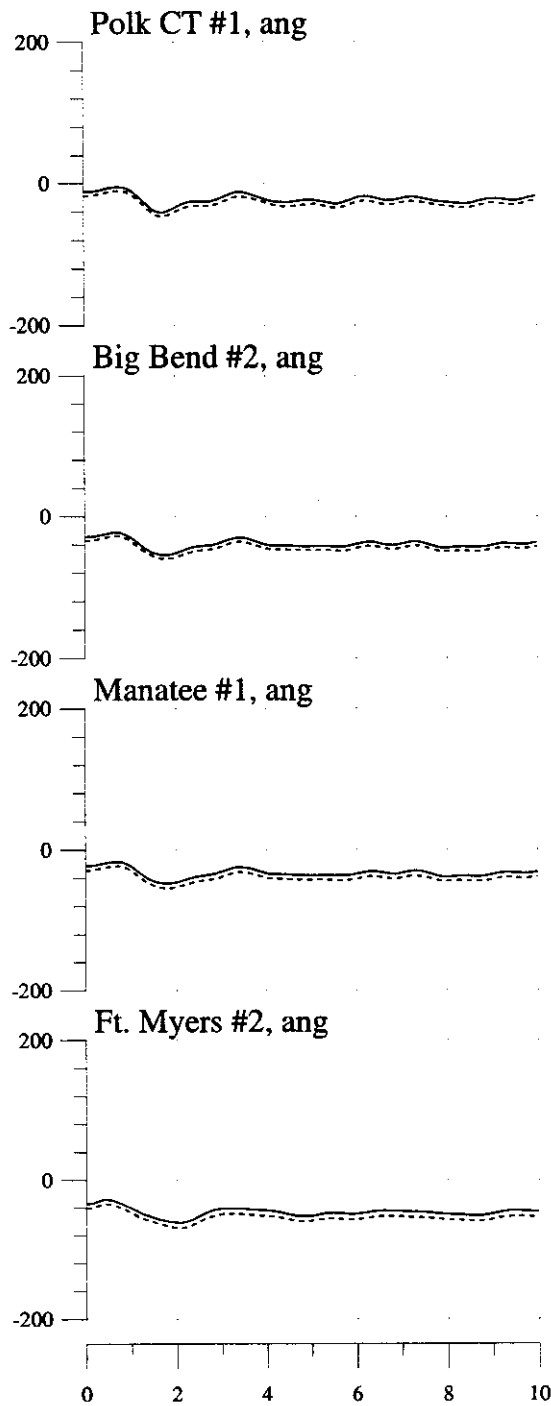
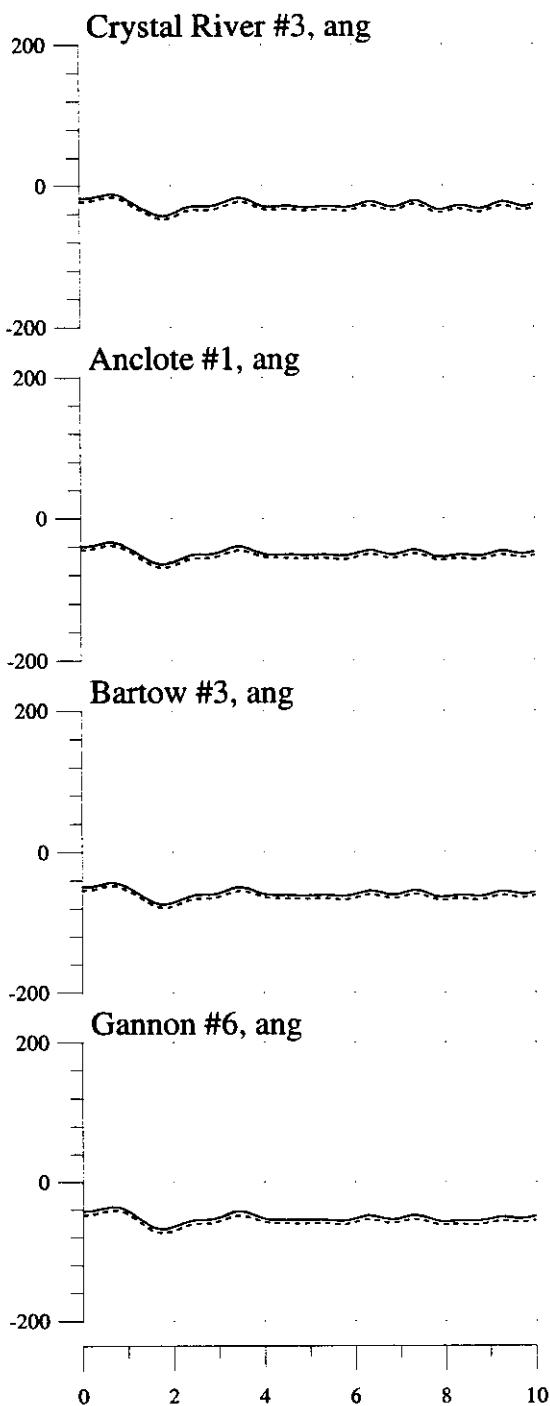

3-phase, 5-cycle Fault at St. Lucie 230kV Bus, Trip St. Lucie #1 & GSU
 2003 Summer System

Machine Variables: (—) With Okeechobee JEA Dispatch, (...) Without

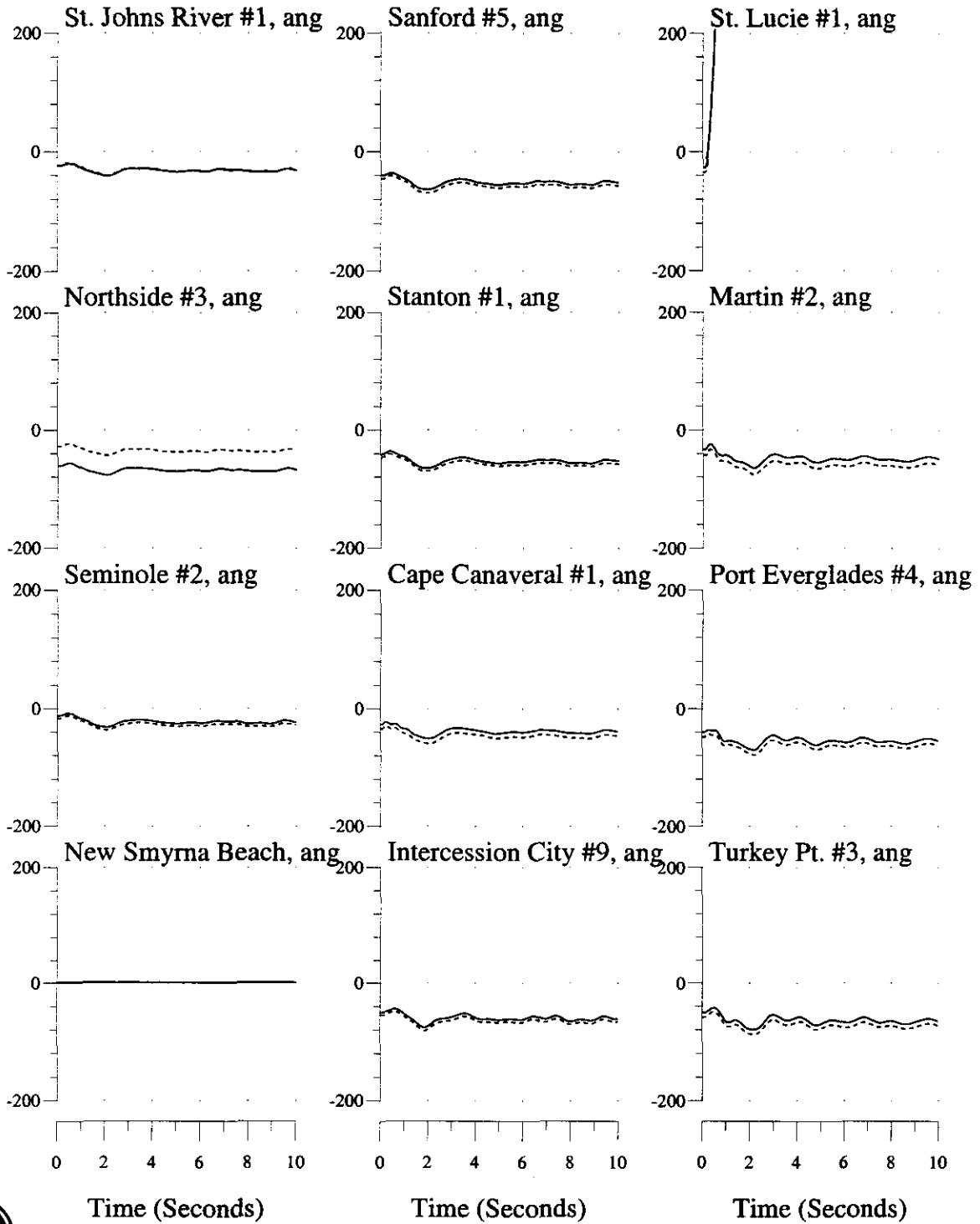

3-phase, 5-cycle Fault at St. Lucie 230kV Bus, Trip St. Lucie #1 & GSU
 2003 Summer System

Bus Variables: (—) With Okeechobee JEA Dispatch, (...) Without

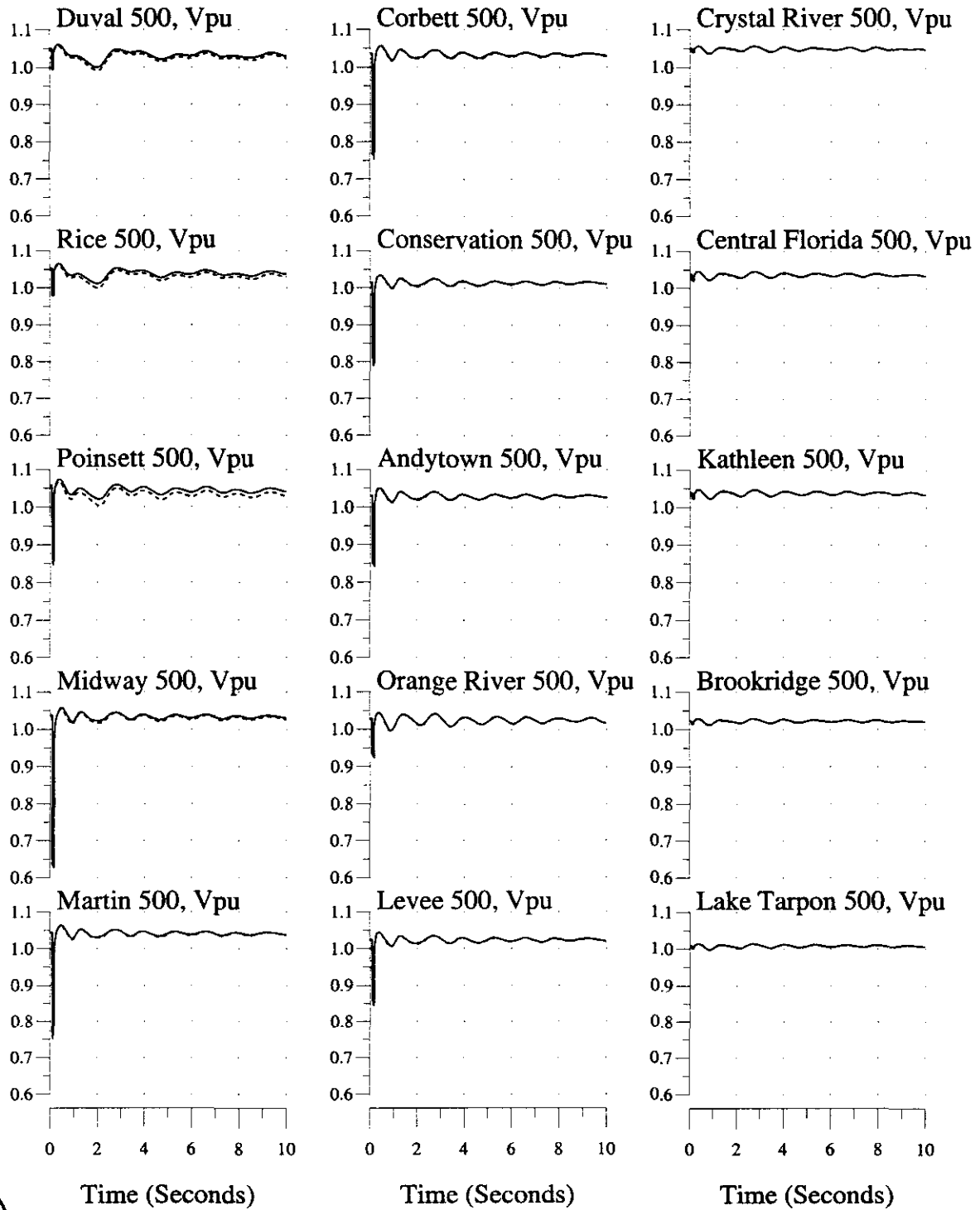

3-phase, 5-cycle Fault at St. Lucie 230kV Bus, Trip St. Lucie #1 & GSU
2003 Summer System

Bus Variables: (—) With Okeechobee JEA Dispatch, (...) Without

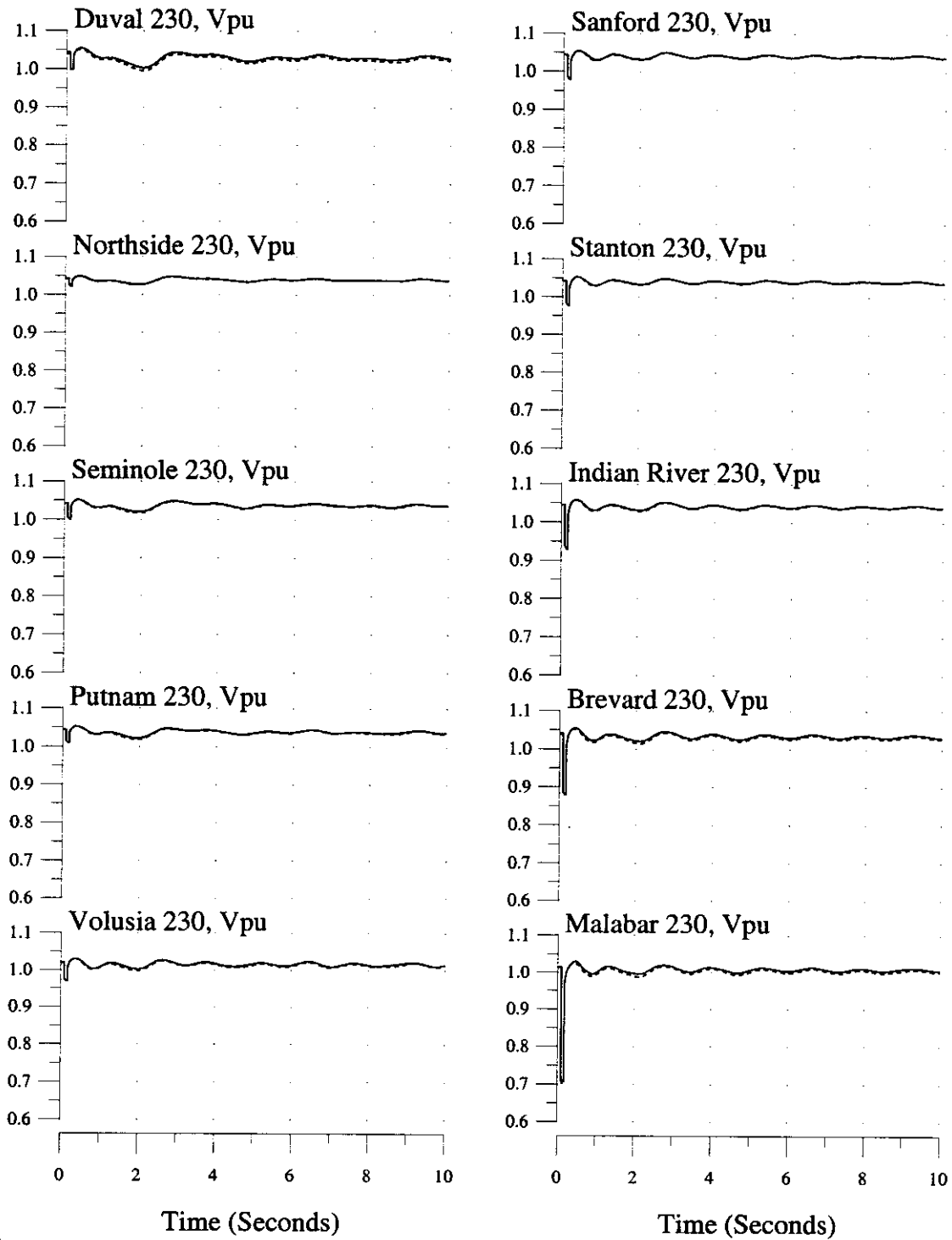

3-phase, 5-cycle Fault at St. Lucie 230kV Bus, Trip St. Lucie #1 & GSU
2003 Summer System

Bus Variables: (___) With Okeechobee JEA Dispatch, (...) Without

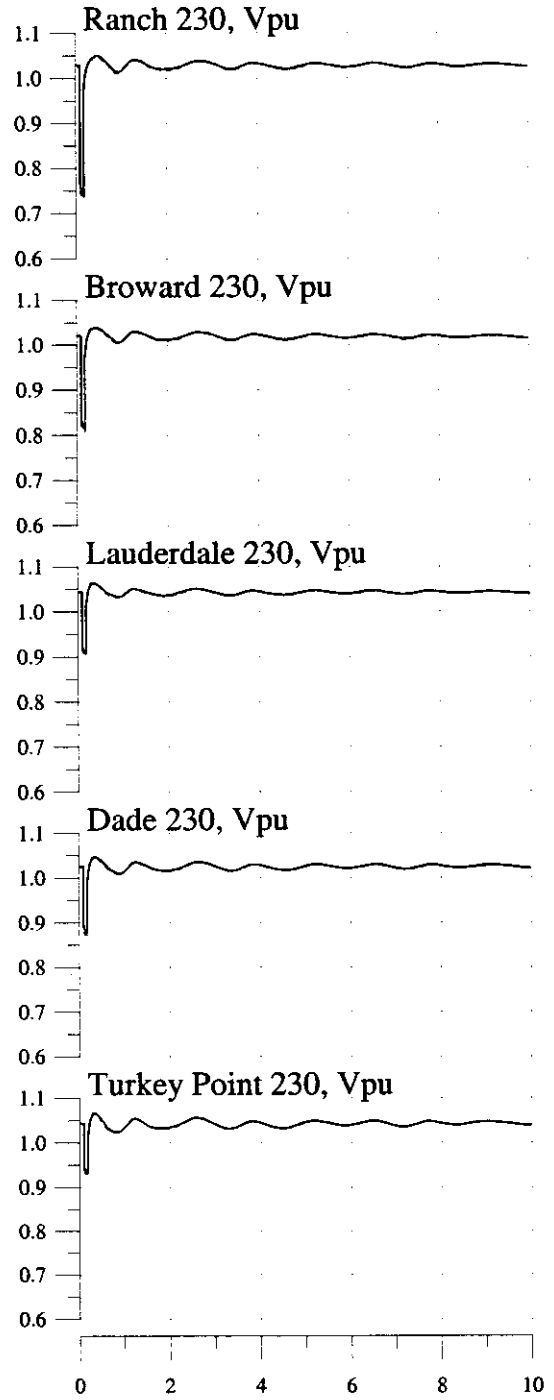
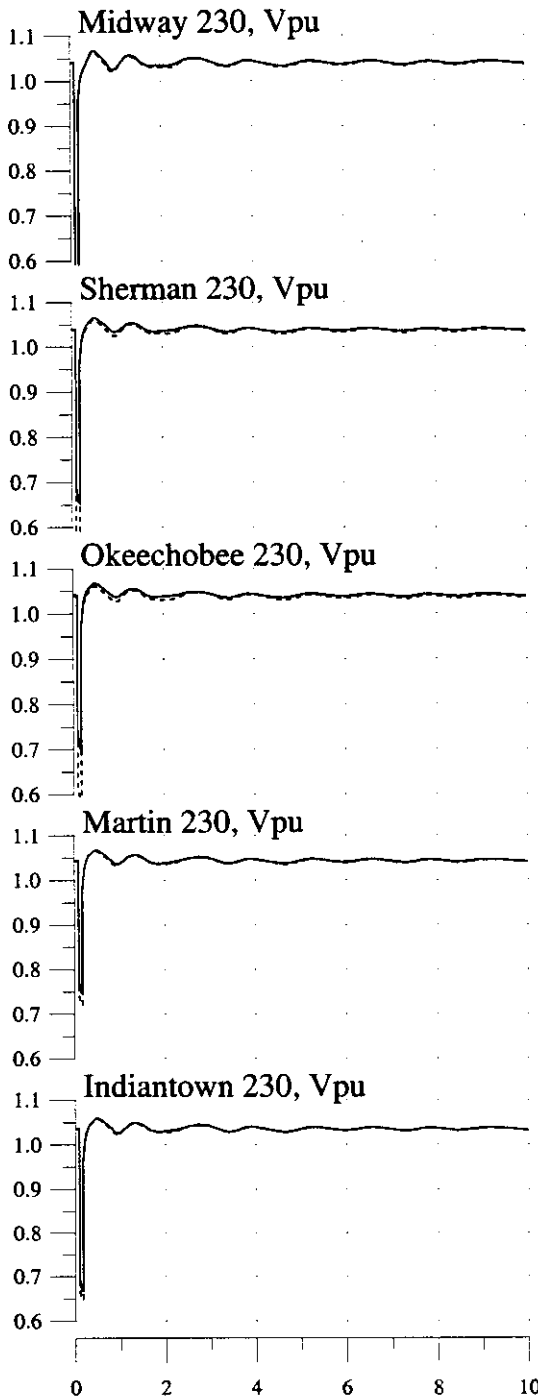

3-phase, 5-cycle Fault at St. Lucie 230kV Bus, Trip St. Lucie #1 & GSU
2003 Summer System

Bus Variables: (___) With Okeechobee JEA Dispatch, (...) Without

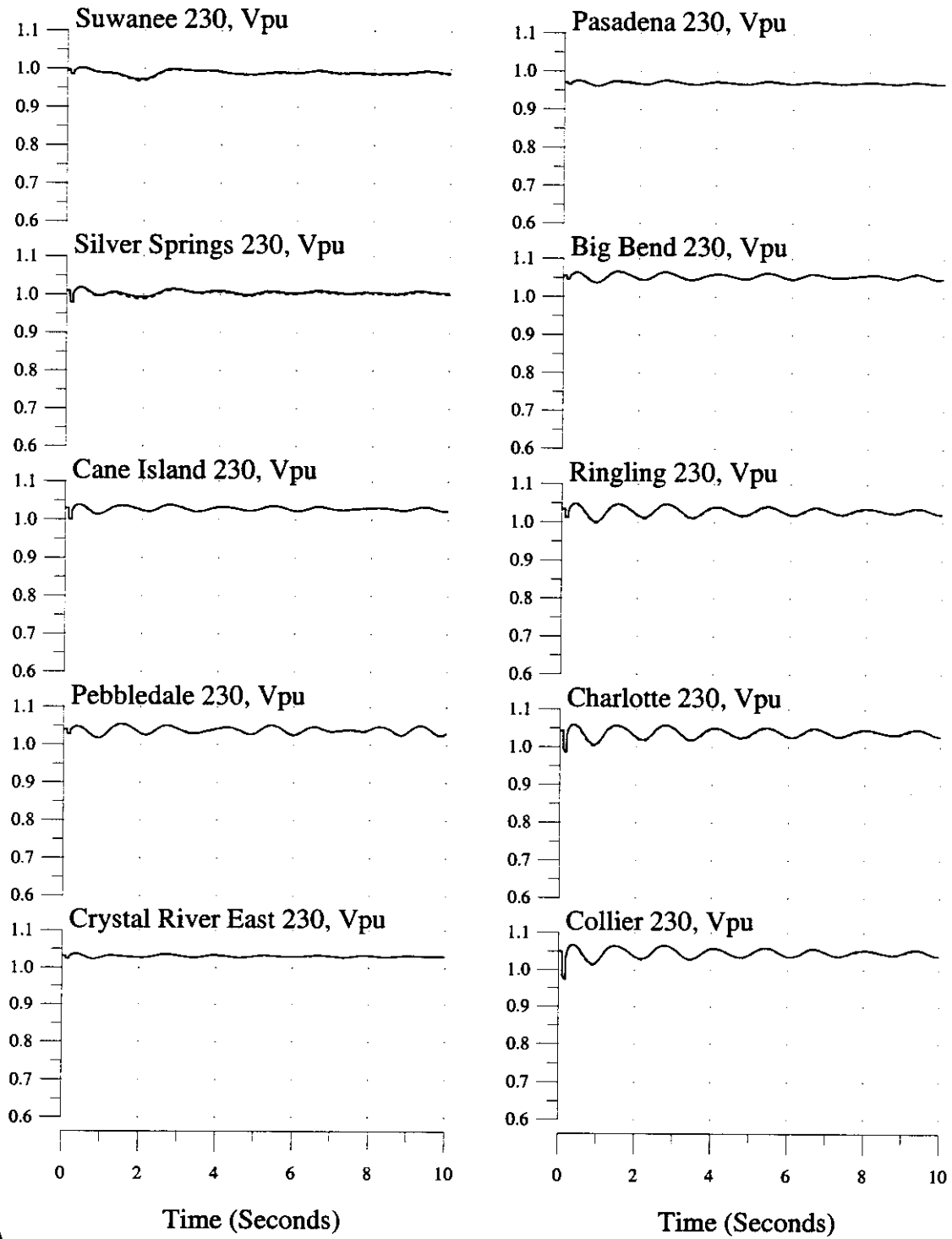

3-phase, 5-cycle Fault at Turkey Pt 230kV Bus, Trip Turkey Pt #3 & GSU
2003 Summer System

Machine & Interface Variables: (—) With Okeechobee JEA Dispatch, (...) Without

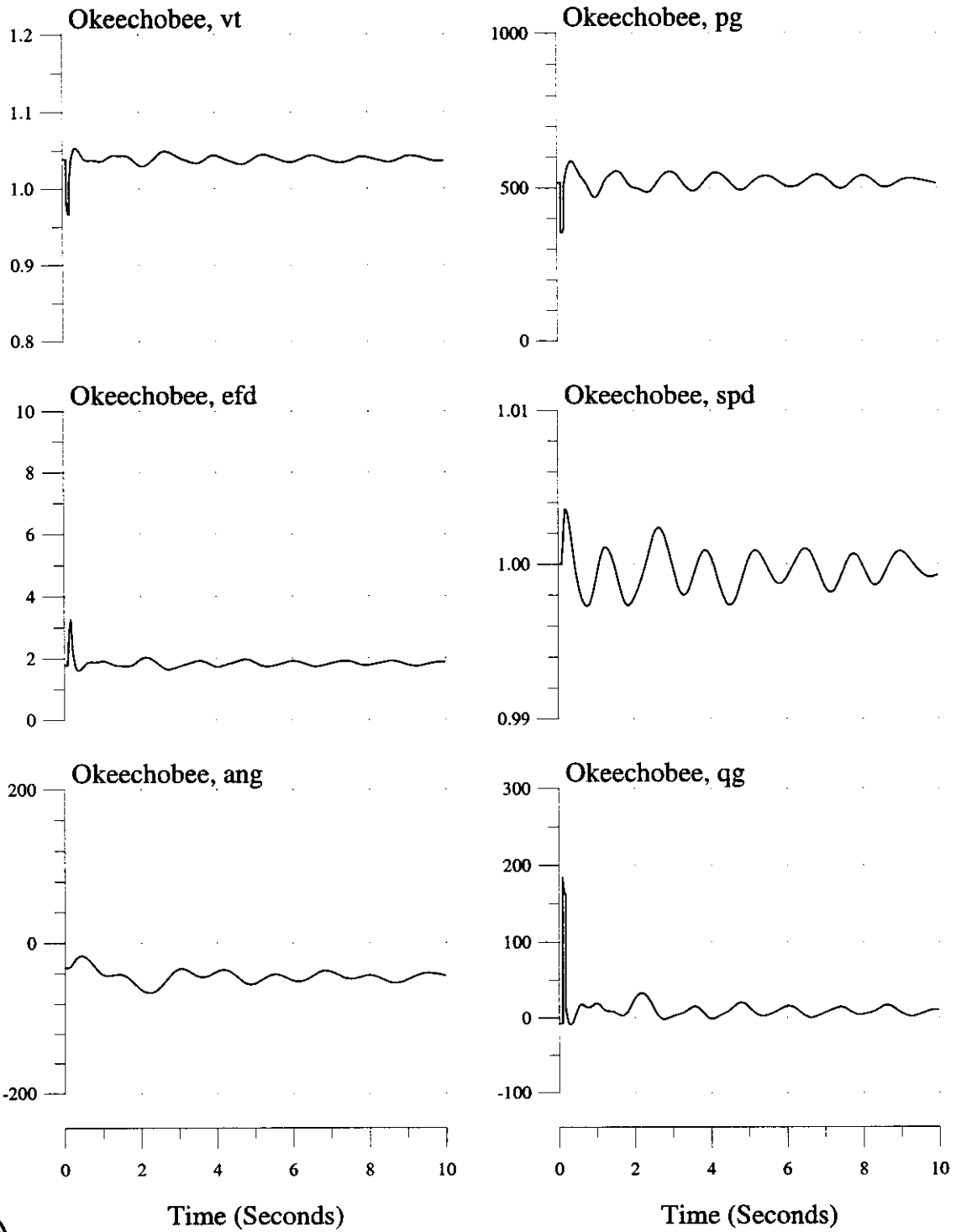

3-phase, 5-cycle Fault at Turkey Pt 230kV Bus, Trip Turkey Pt #3 & GSU
2003 Summer System

Machine & Interface Variables: (—) With Okeechobee JEA Dispatch, (...) Without

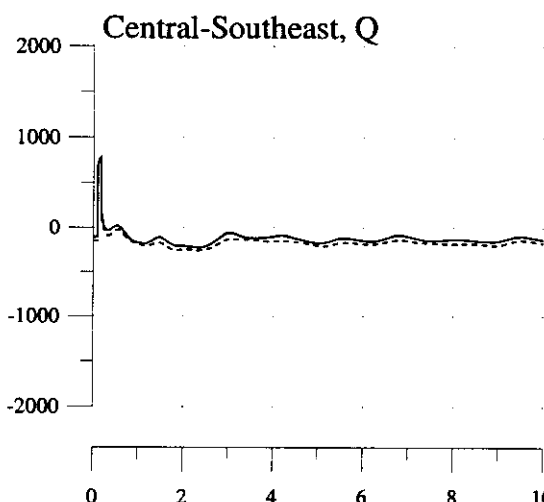
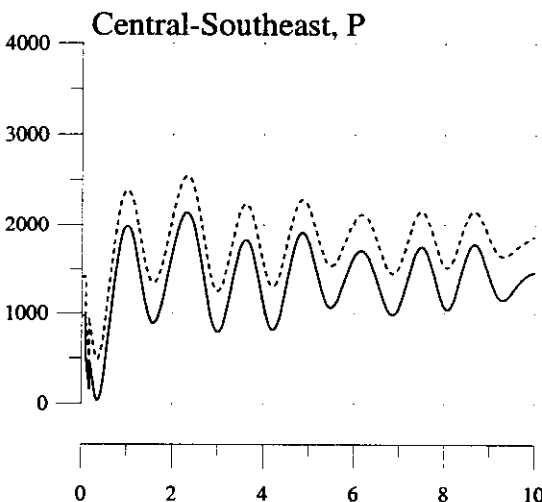
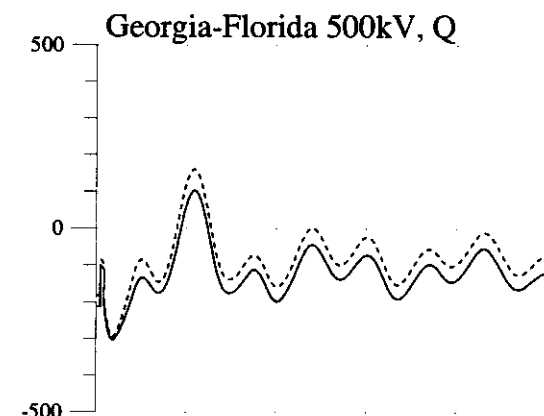
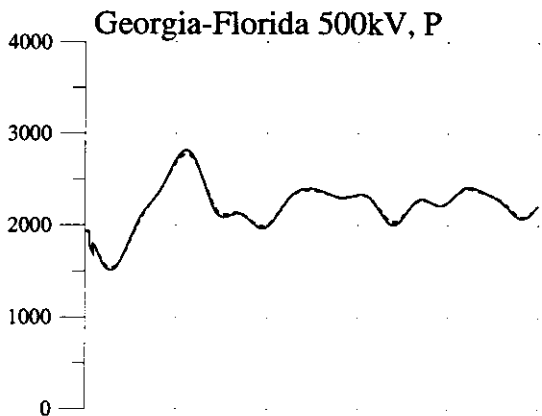
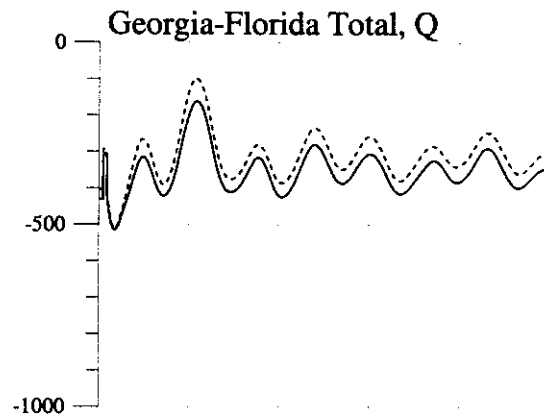
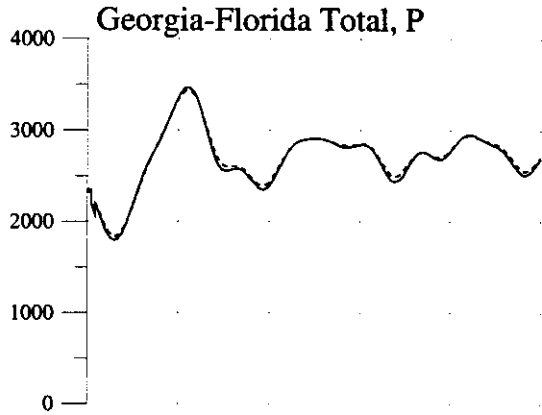

Time (Seconds)

Time (Seconds)



3-phase, 5-cycle Fault at Turkey Pt 230kV Bus, Trip Turkey Pt #3 & GSU
2003 Summer System

Machine Variables: (—) With Okeechobee JEA Dispatch, (...) Without

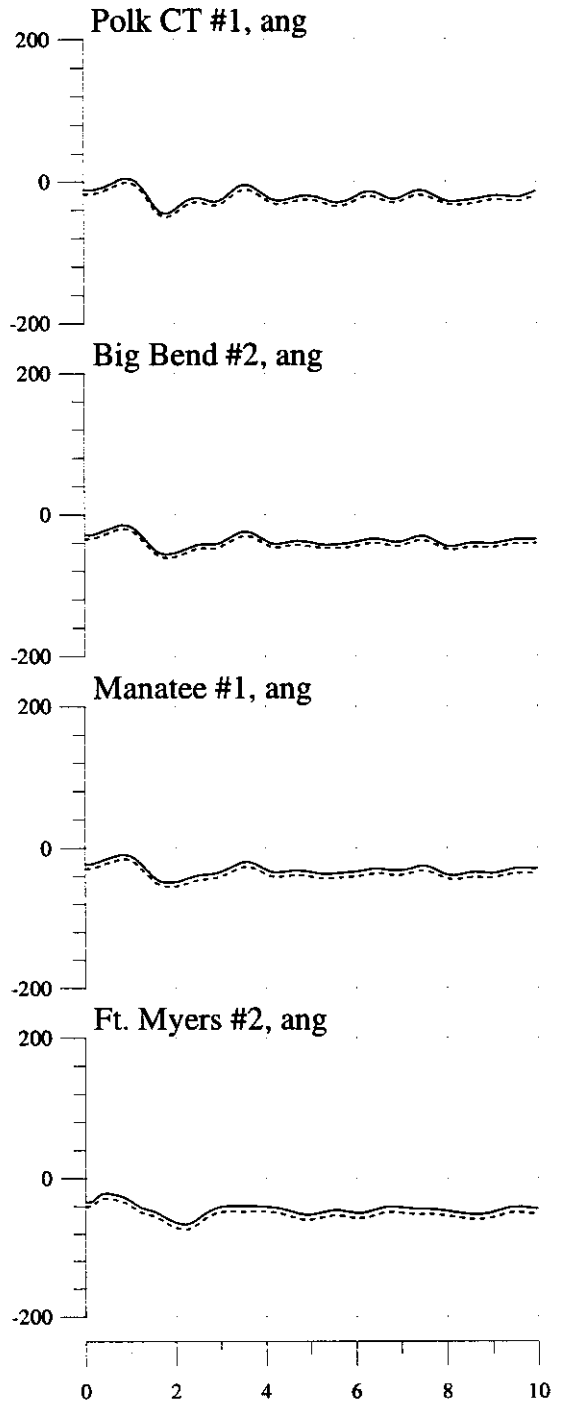
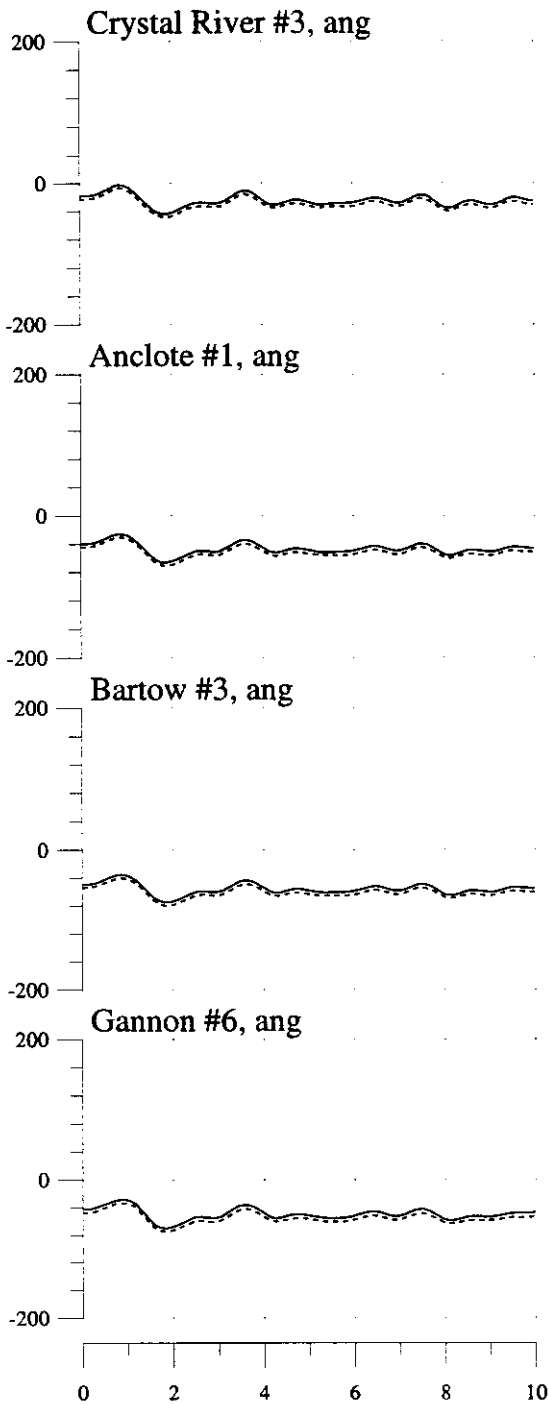

3-phase, 5-cycle Fault at Turkey Pt 230kV Bus, Trip Turkey Pt #3 & GSU
 2003 Summer System

Machine Variables: (—) With Okeechobee JEA Dispatch, (...) Without

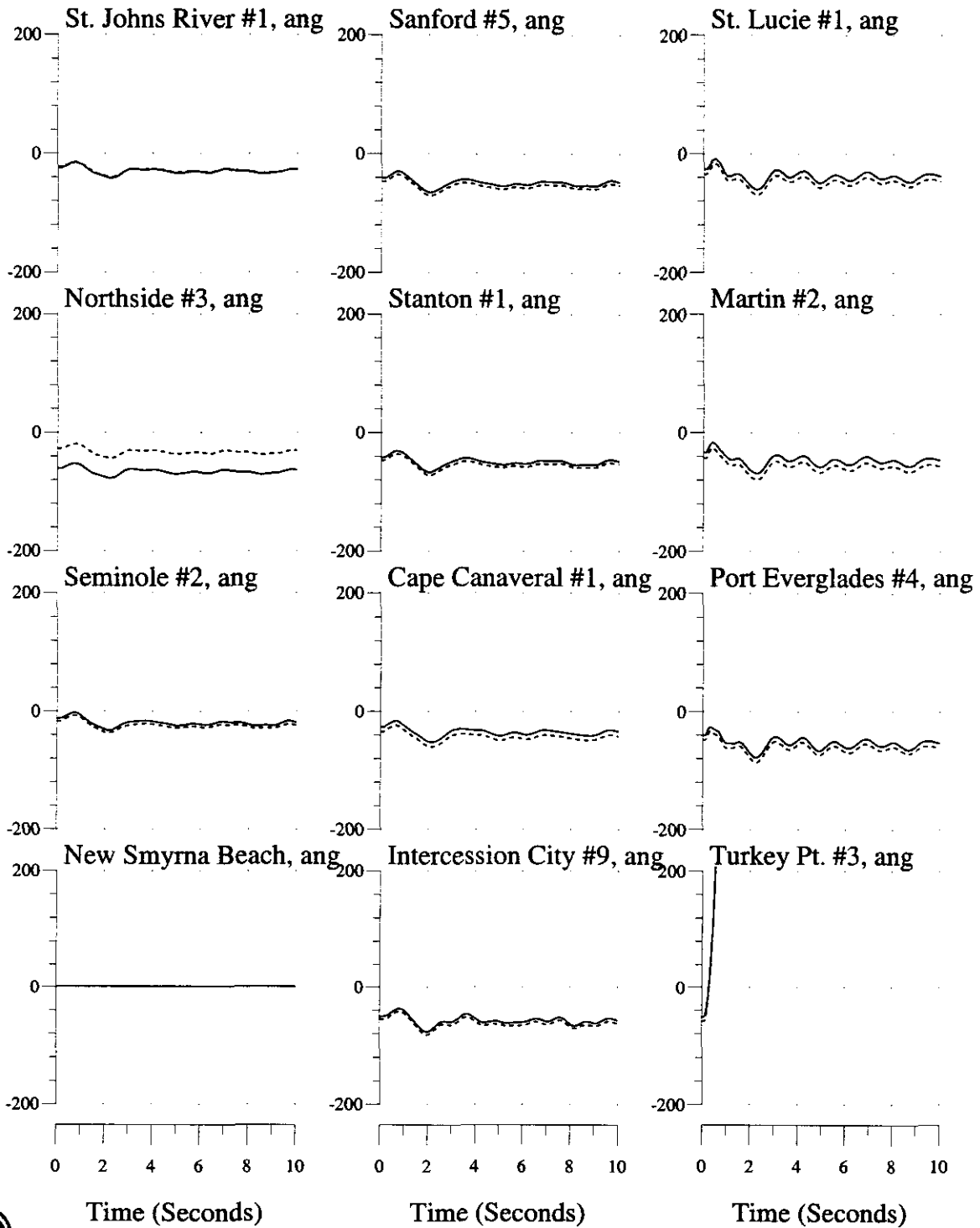

3-phase, 5-cycle Fault at Turkey Pt 230kV Bus, Trip Turkey Pt #3 & GSU
 2003 Summer System

Bus Variables: (—) With Okeechobee JEA Dispatch, (...) Without

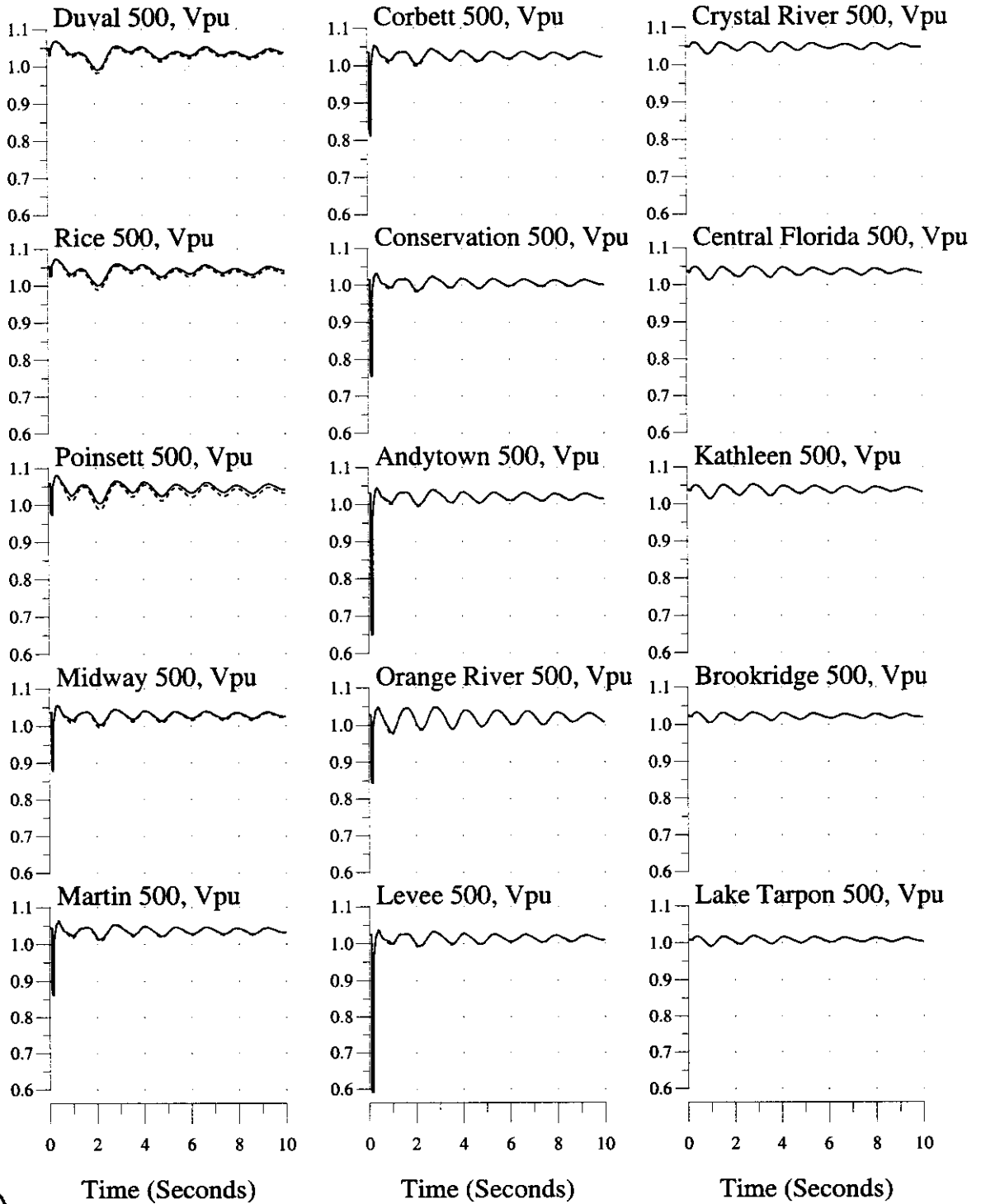

3-phase, 5-cycle Fault at Turkey Pt 230kV Bus, Trip Turkey Pt #3 & GSU
2003 Summer System

Bus Variables: (—) With Okeechobee JEA Dispatch, (...) Without

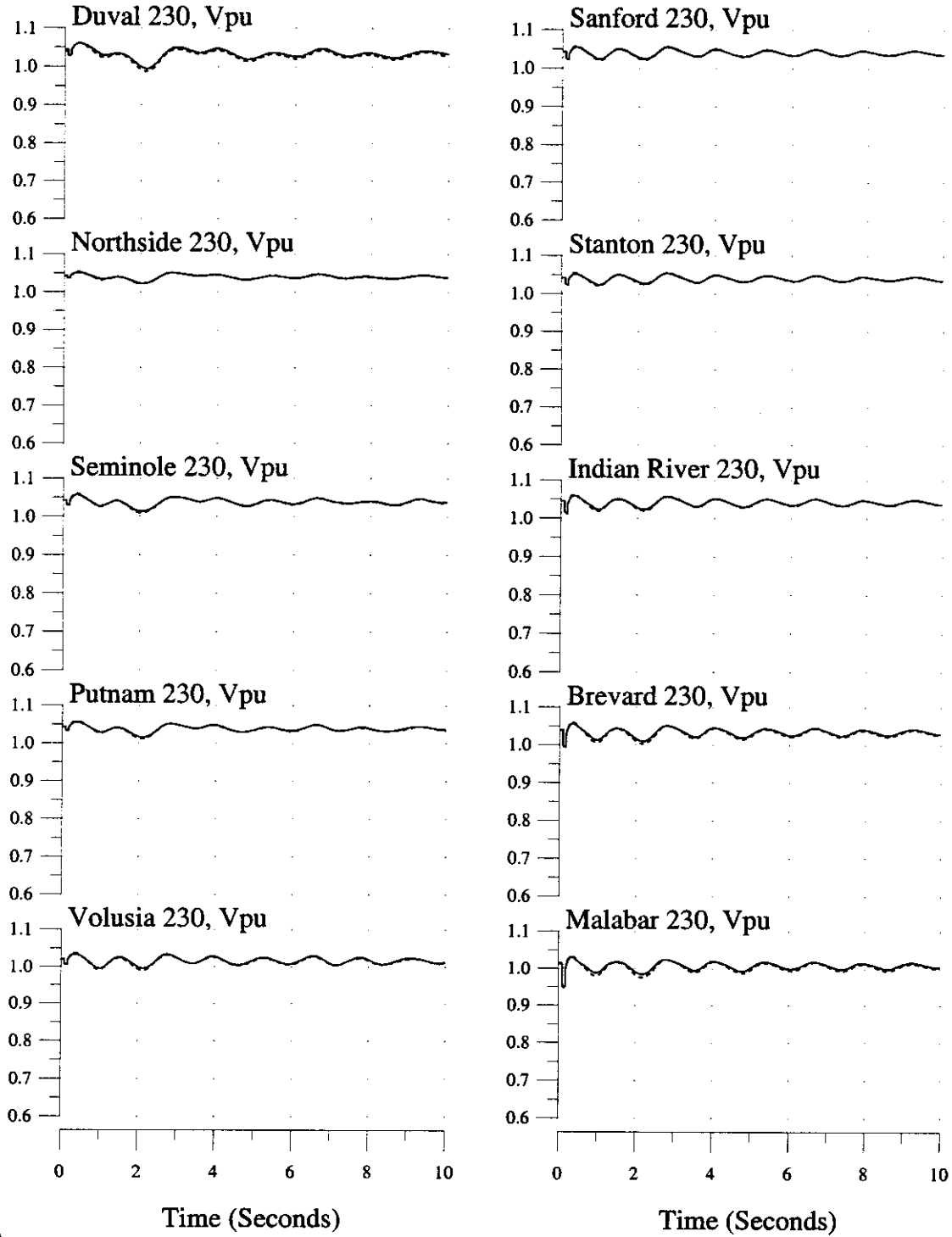

3-phase, 5-cycle Fault at Turkey Pt 230kV Bus, Trip Turkey Pt #3 & GSU
2003 Summer System

Bus Variables: (—) With Okeechobee JEA Dispatch, (...) Without

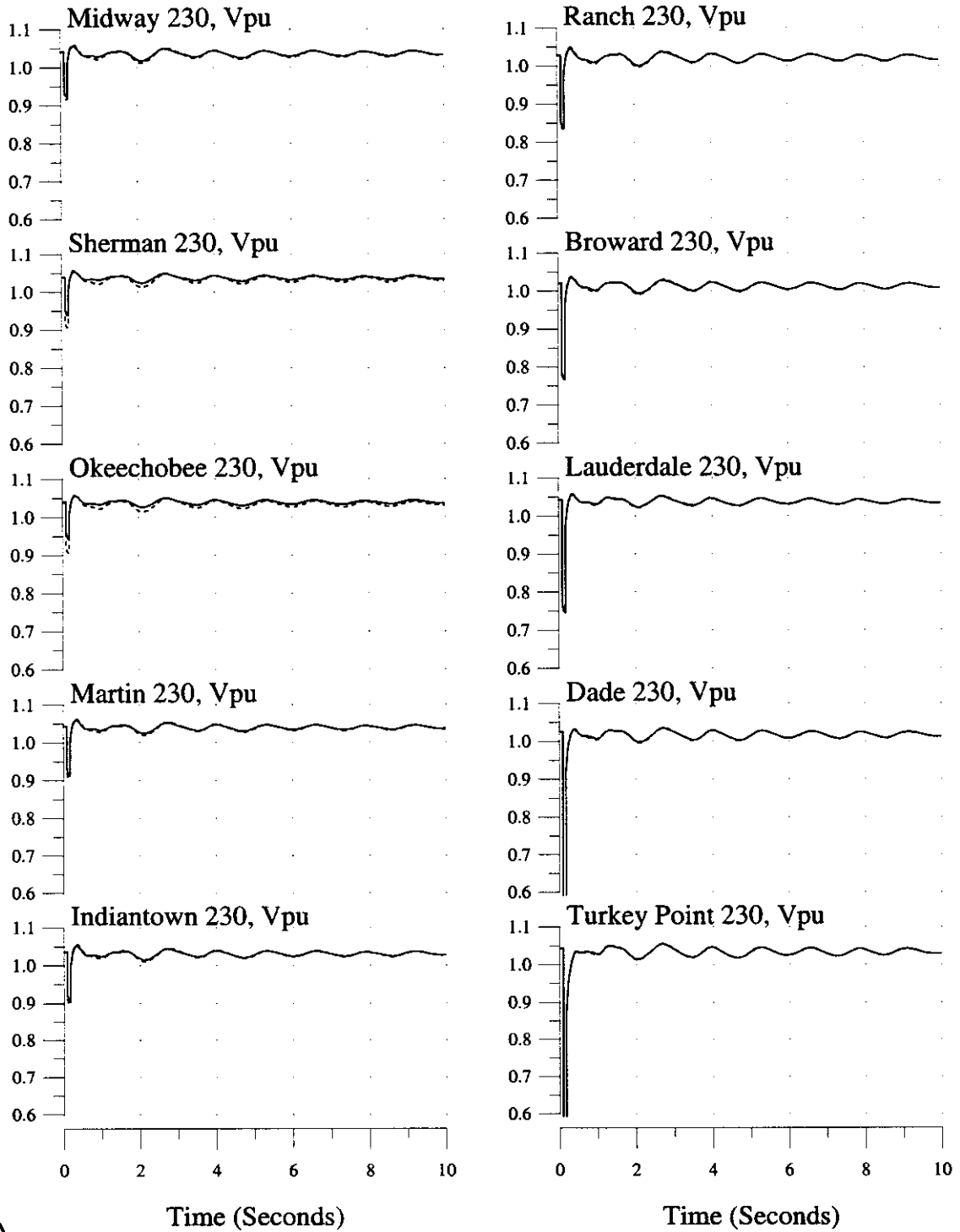

3-phase, 5-cycle Fault at Turkey Pt 230kV Bus, Trip Turkey Pt #3 & GSU
 2003 Summer System

Bus Variables: (—) With Okeechobee JEA Dispatch, (...) Without

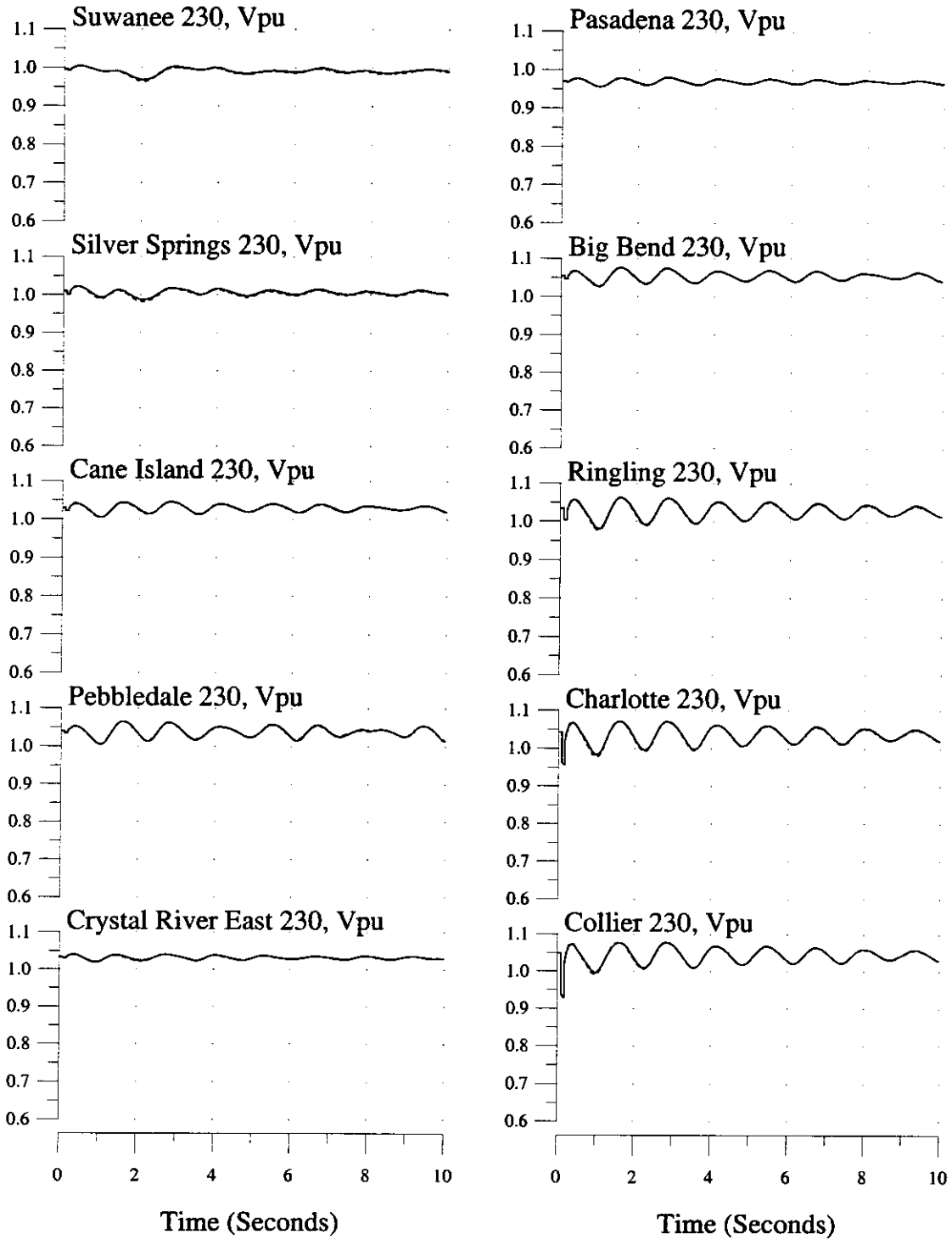

3-phase, 5-cycle Fault at Seminole 230kV Bus, Trip Seminole #1 & GSU
2003 Summer System

Machine & Interface Variables: (—) With Okeechobee JEA Dispatch, (...) Without

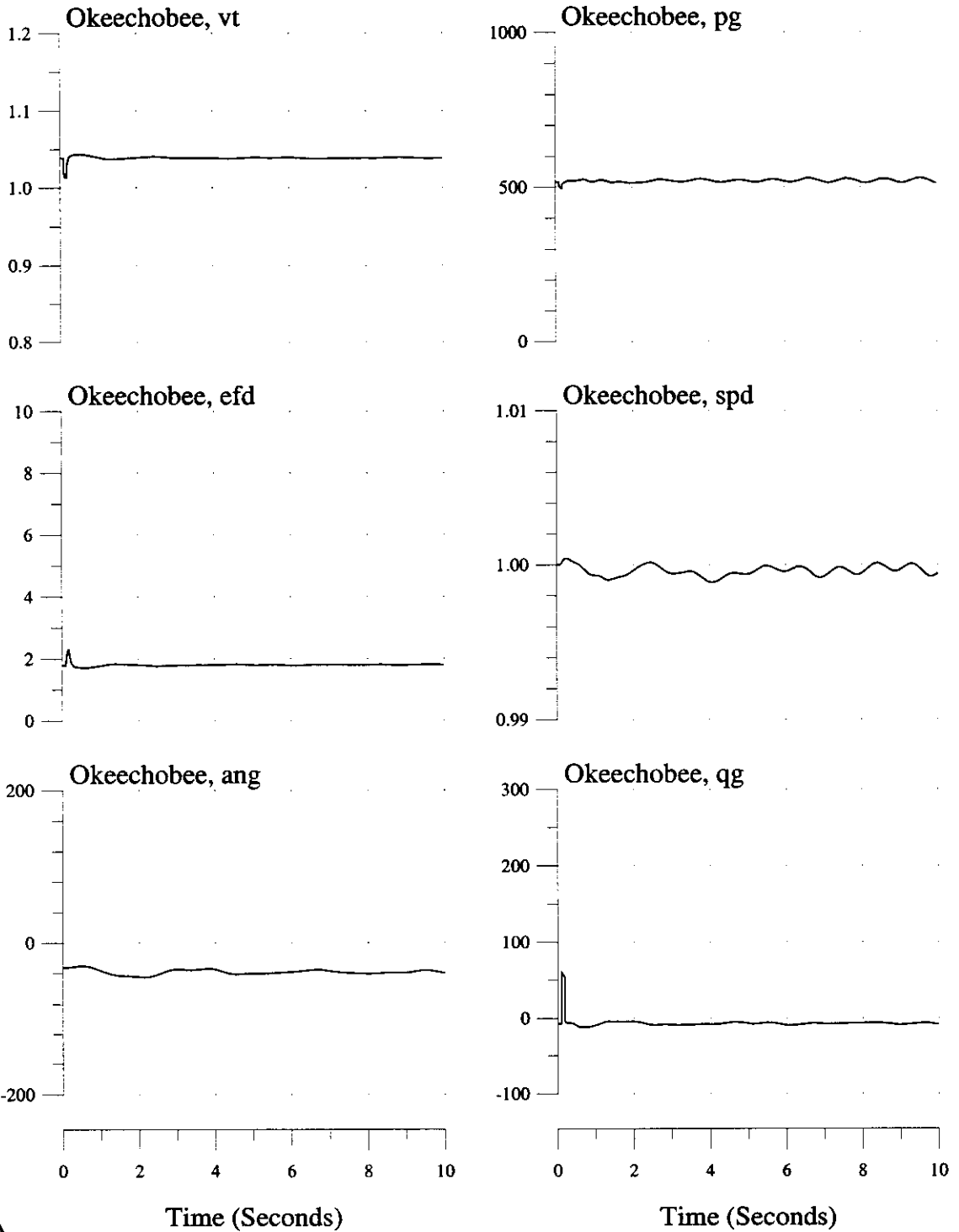

3-phase, 5-cycle Fault at Seminole 230kV Bus, Trip Seminole #1 & GSU
2003 Summer System

Machine & Interface Variables: (—) With Okeechobee JEA Dispatch, (...) Without

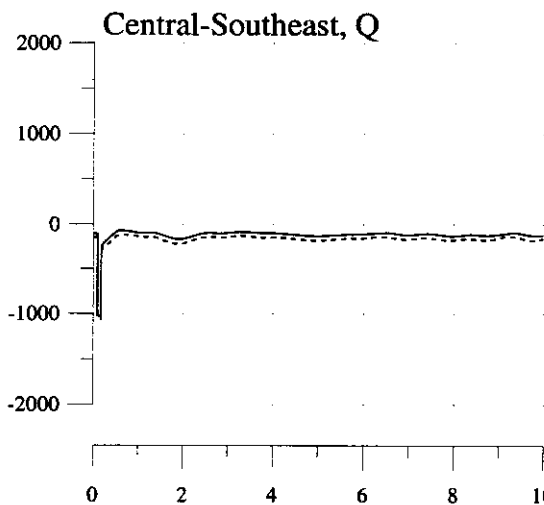
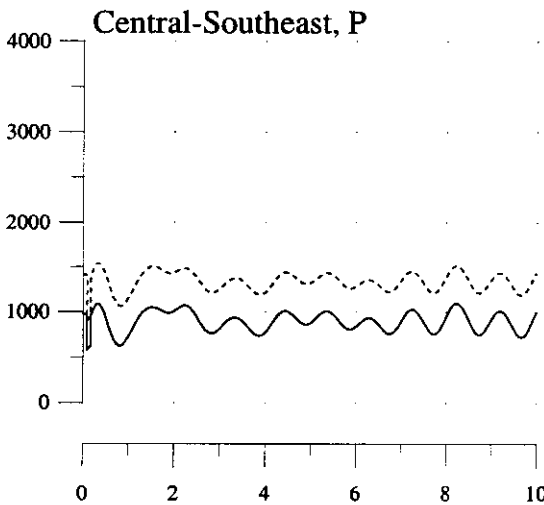
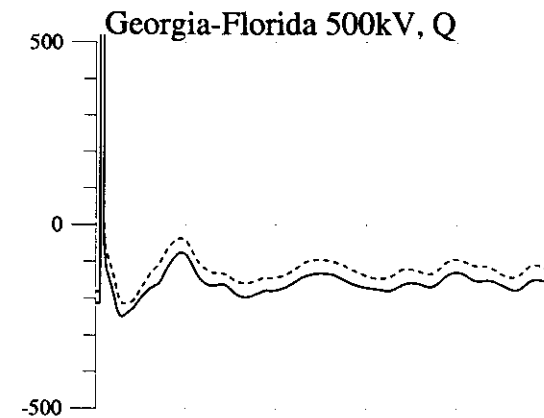
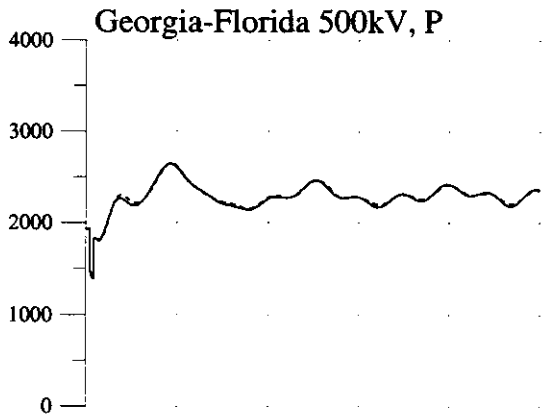
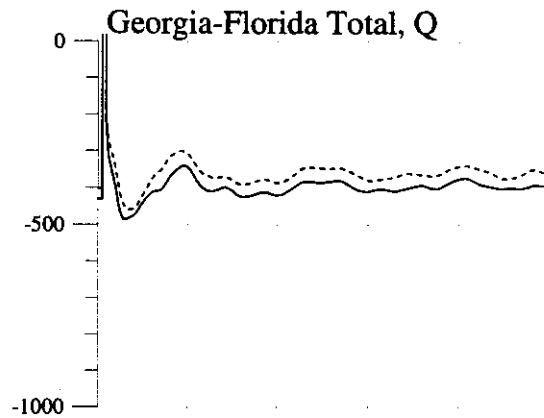
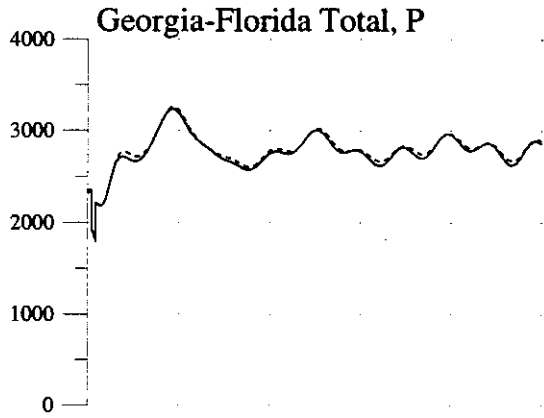

Time (Seconds)

Time (Seconds)



3-phase, 5-cycle Fault at Seminole 230kV Bus, Trip Seminole #1 & GSU
2003 Summer System

Machine Variables: (—) With Okeechobee JEA Dispatch, (...) Without

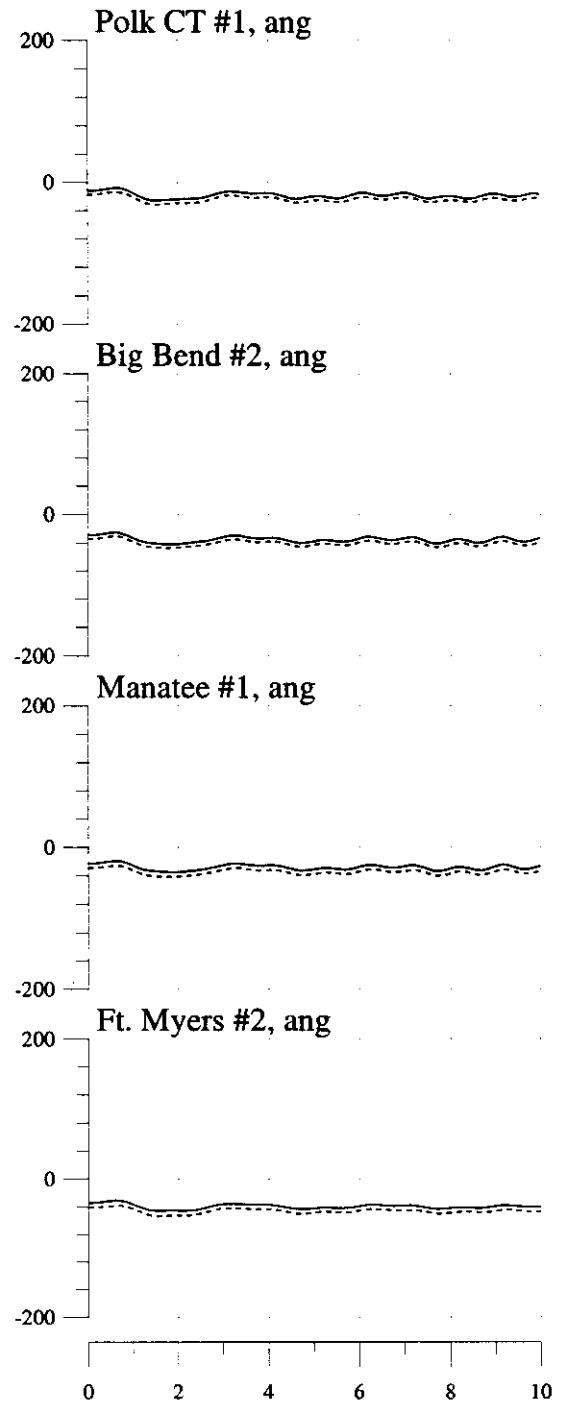
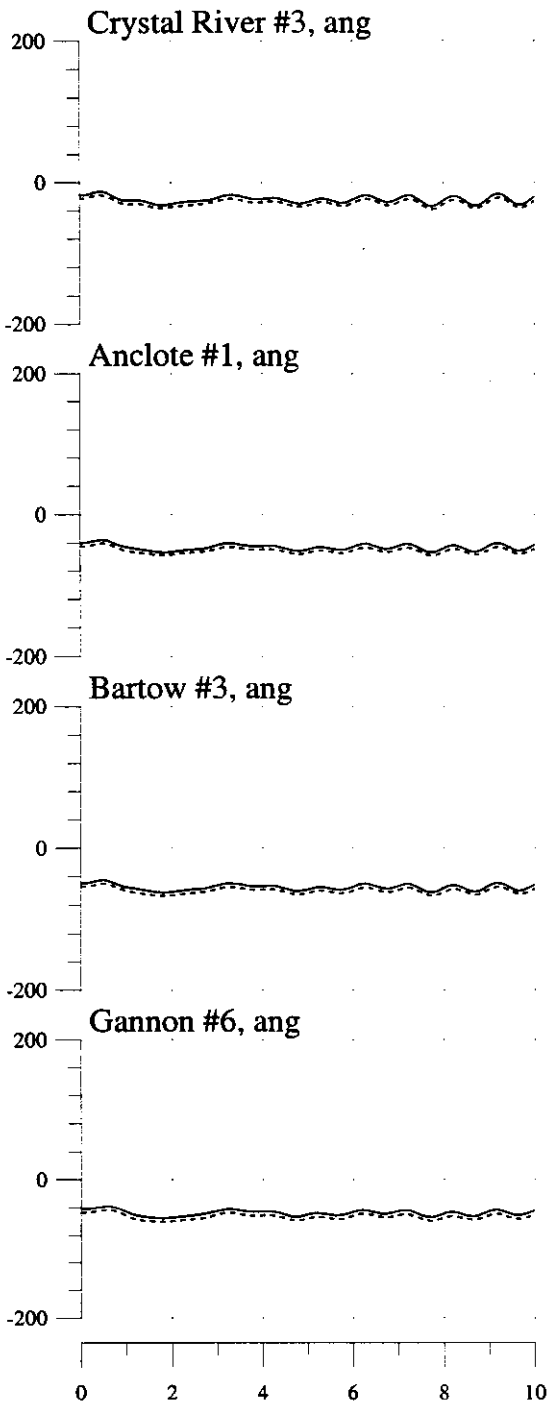

3-phase, 5-cycle Fault at Seminole 230kV Bus, Trip Seminole #1 & GSU
2003 Summer System

Machine Variables: (—) With Okeechobee JEA Dispatch, (...) Without

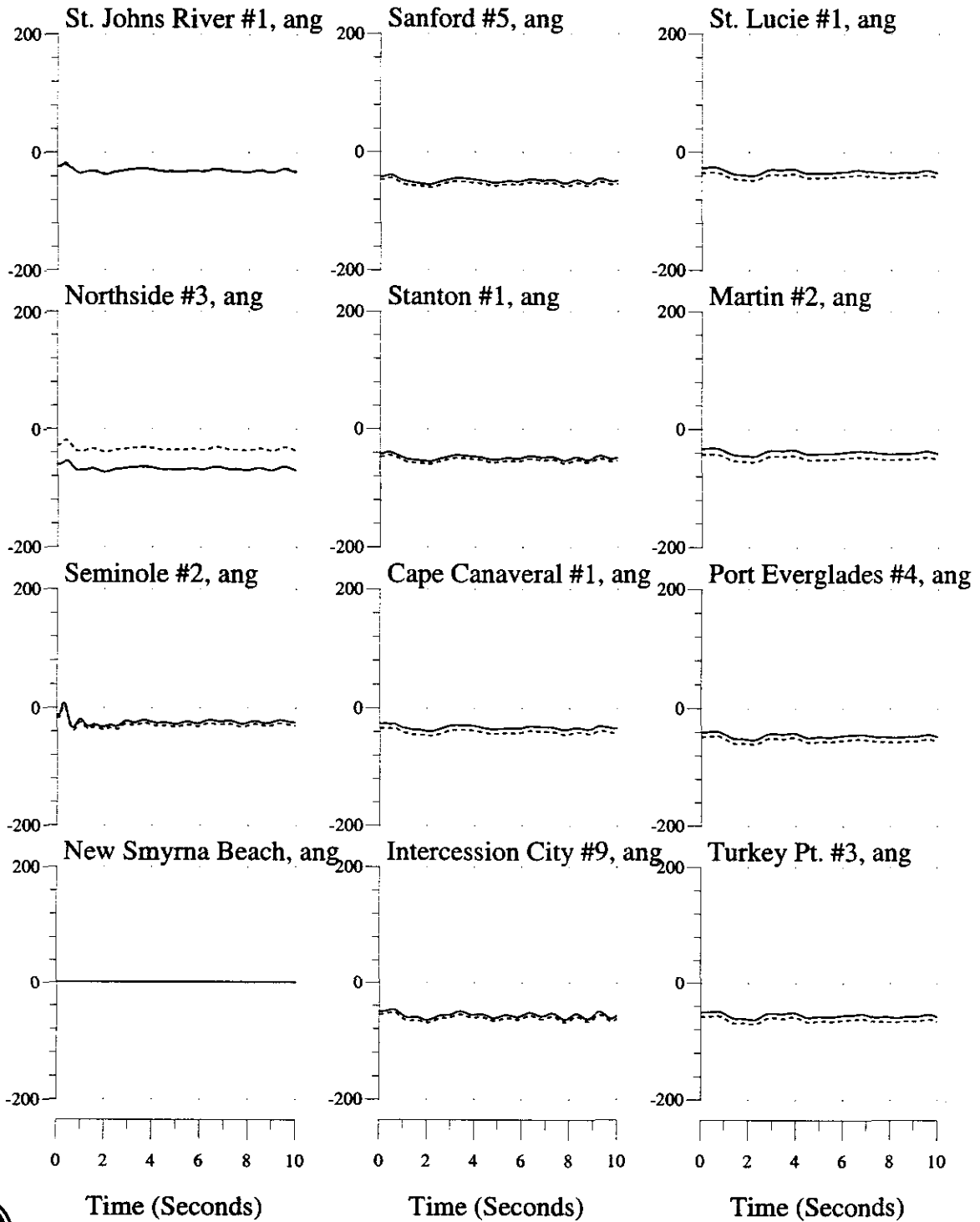

3-phase, 5-cycle Fault at Seminole 230kV Bus, Trip Seminole #1 & GSU
 2003 Summer System

Bus Variables: (___) With Okeechobee JEA Dispatch, (...) Without

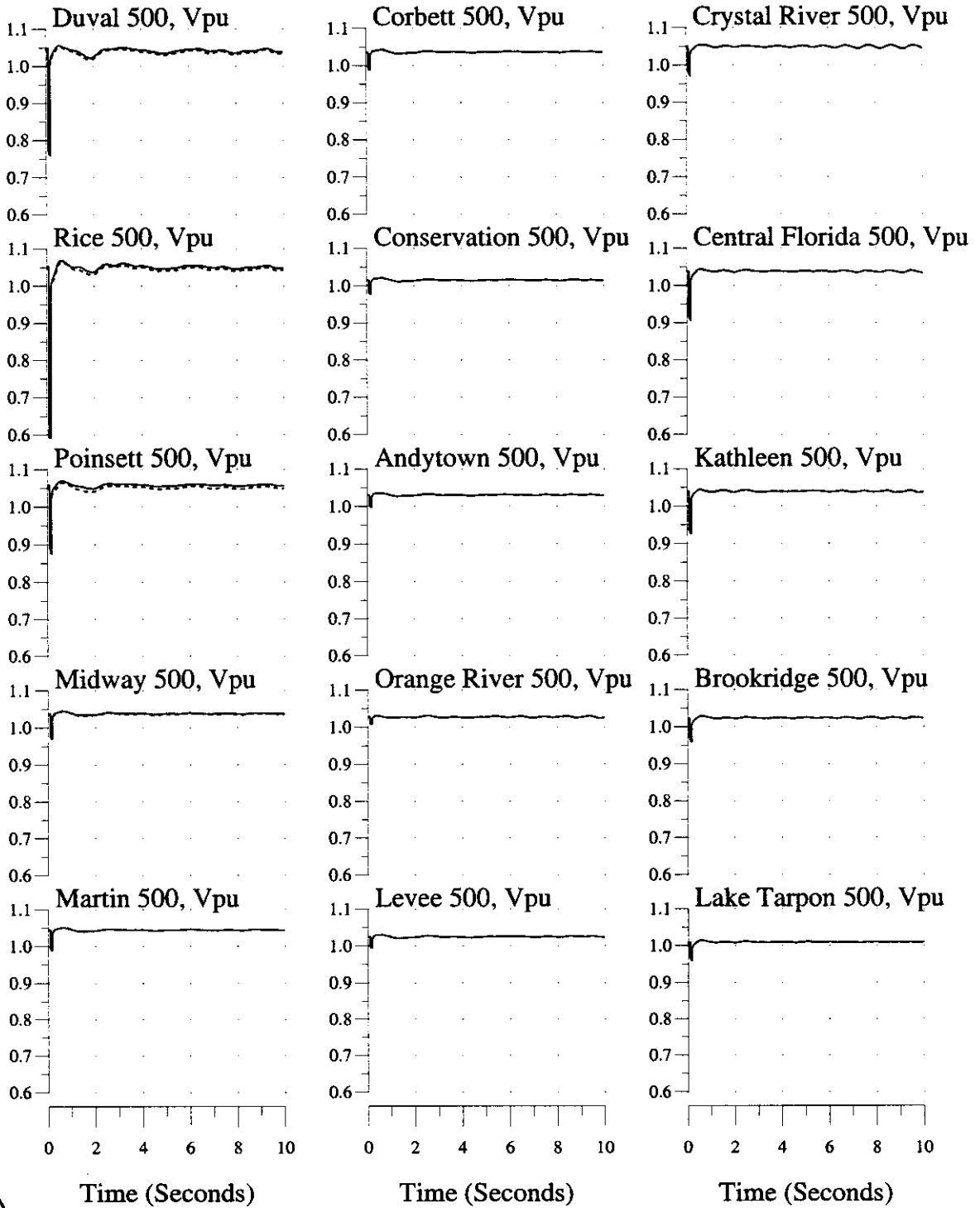

3-phase, 5-cycle Fault at Seminole 230kV Bus, Trip Seminole #1 & GSU
2003 Summer System

Bus Variables: (___) With Okeechobee JEA Dispatch, (...) Without

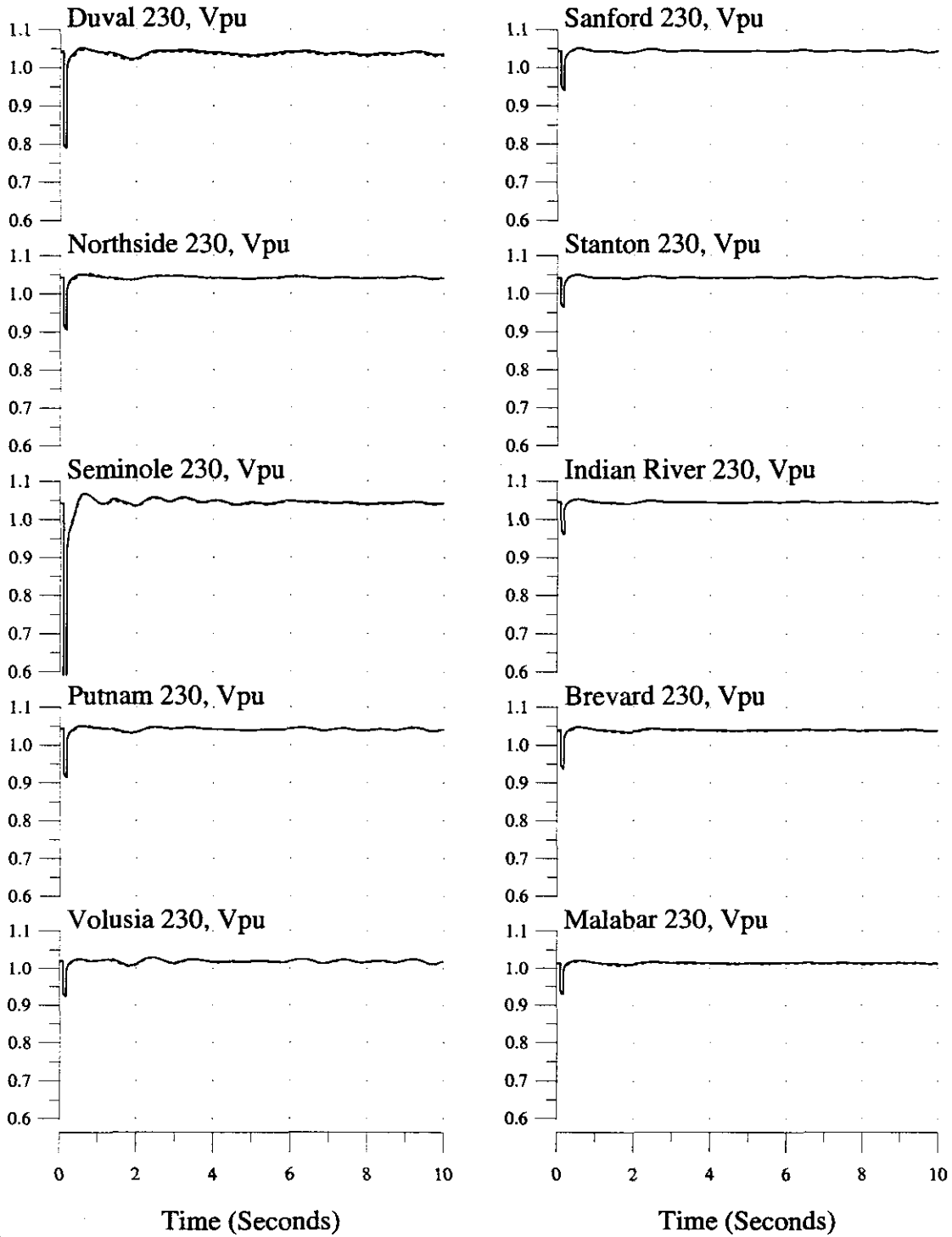

3-phase, 5-cycle Fault at Seminole 230kV Bus, Trip Seminole #1 & GSU
2003 Summer System

Bus Variables: (___) With Okeechobee JEA Dispatch, (...) Without

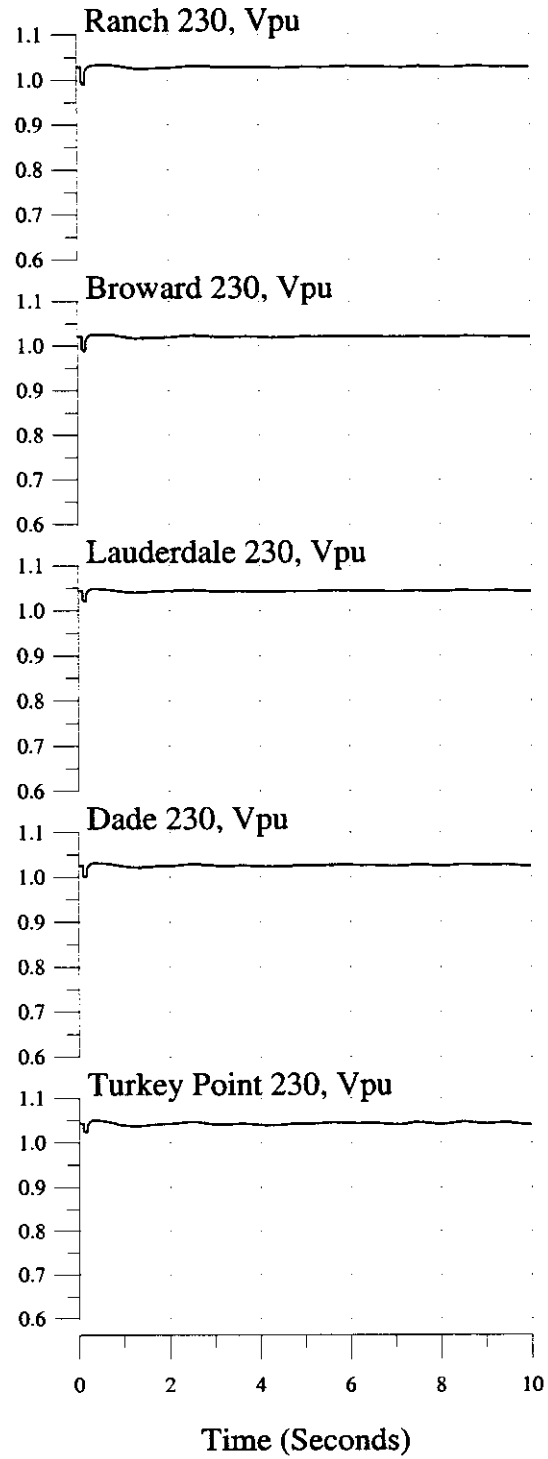
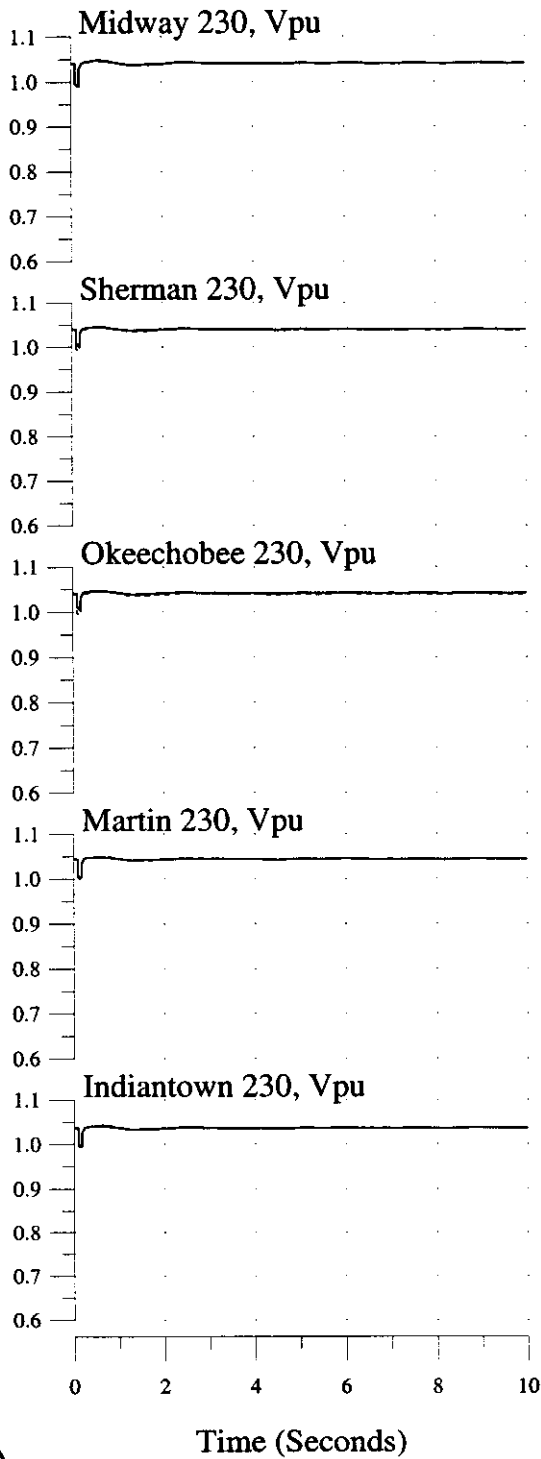

3-phase, 5-cycle Fault at Seminole 230kV Bus, Trip Seminole #1 & GSU
 2003 Summer System

Bus Variables: (—) With Okeechobee JEA Dispatch, (...) Without

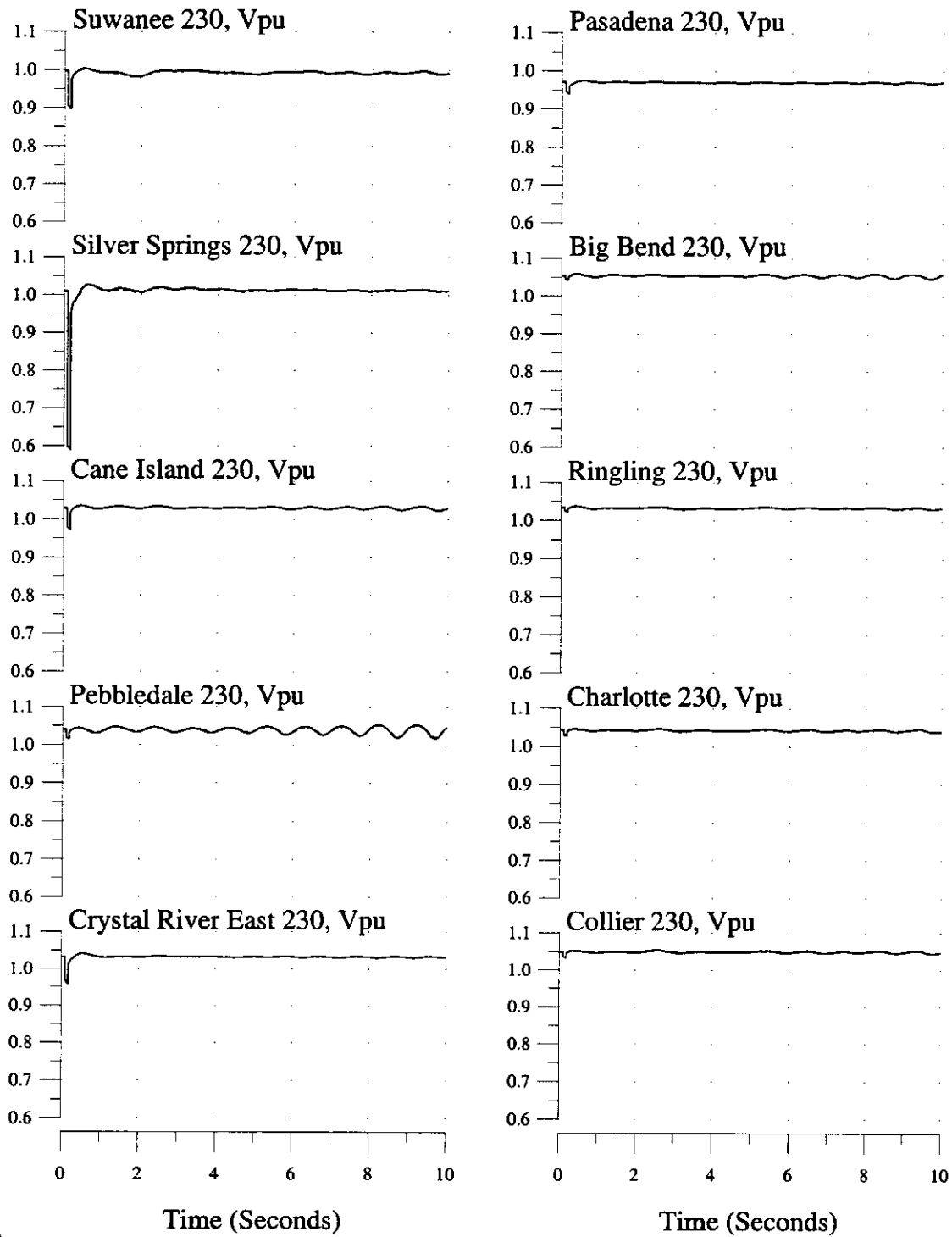

3-phase, 5-cycle Fault at Martin 500kV Bus, Trip Martin #2 & GSU
2003 Summer System

Machine & Interface Variables: (—) With Okeechobee JEA Dispatch, (...) Without

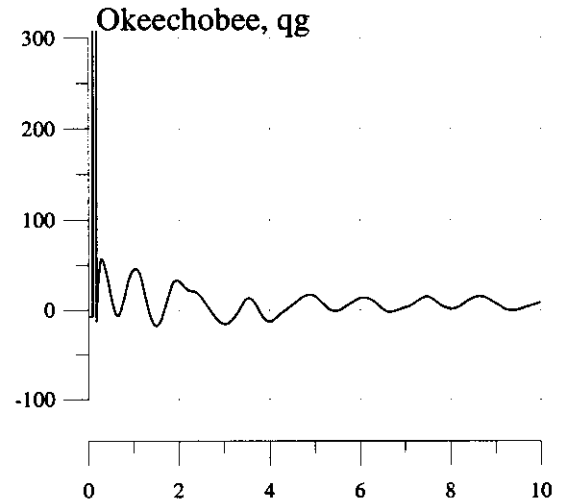
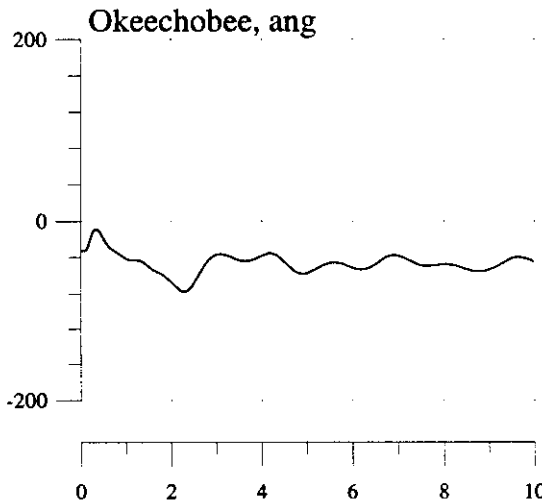
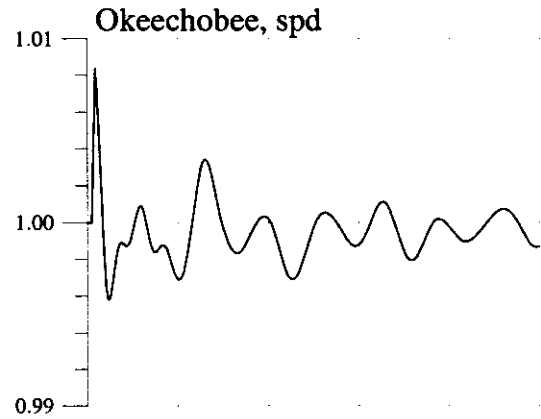
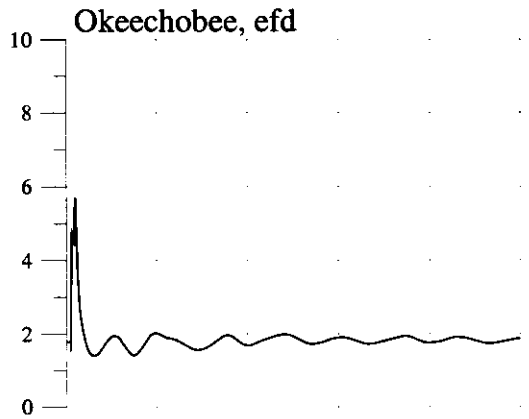
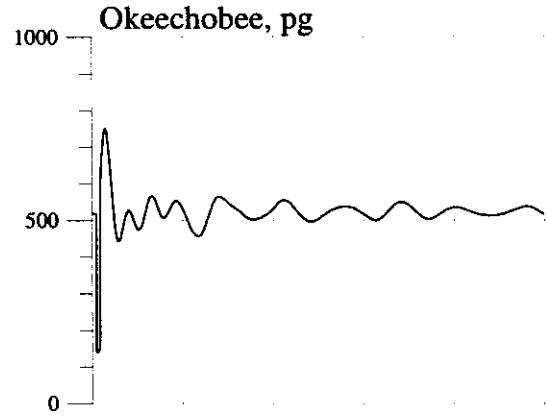
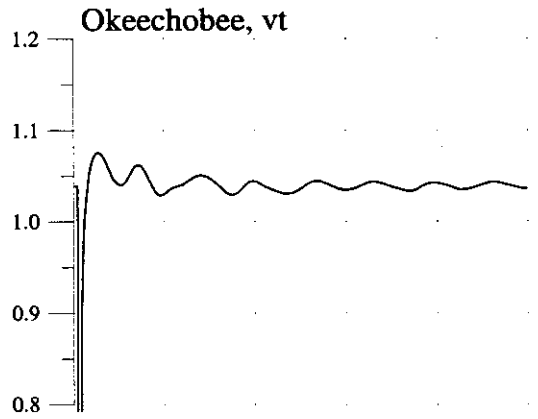

Time (Seconds)

Time (Seconds)



3-phase, 5-cycle Fault at Martin 500kV Bus, Trip Martin #2 & GSU
2003 Summer System

Machine & Interface Variables: (—) With Okeechobee JEA Dispatch, (...) Without

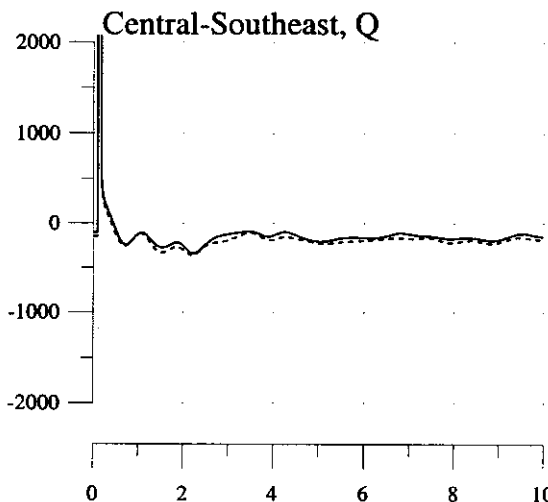
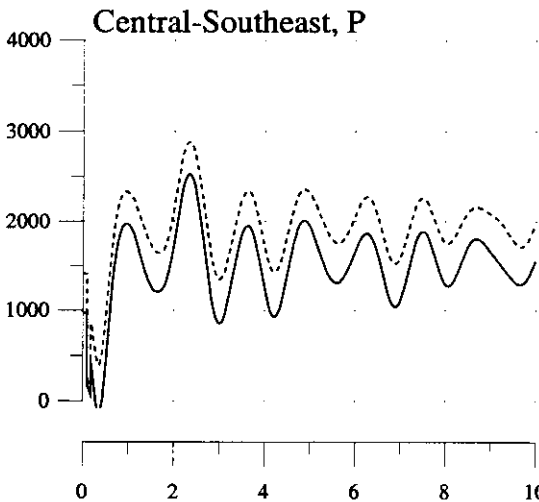
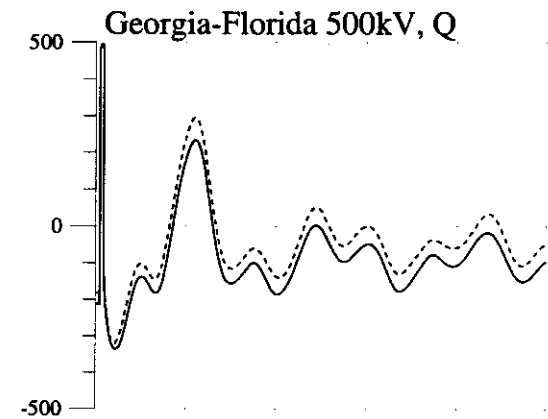
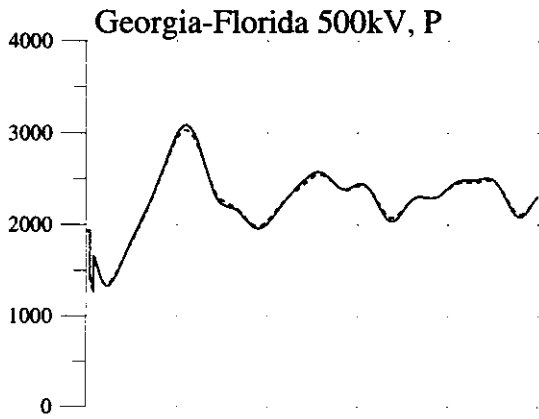
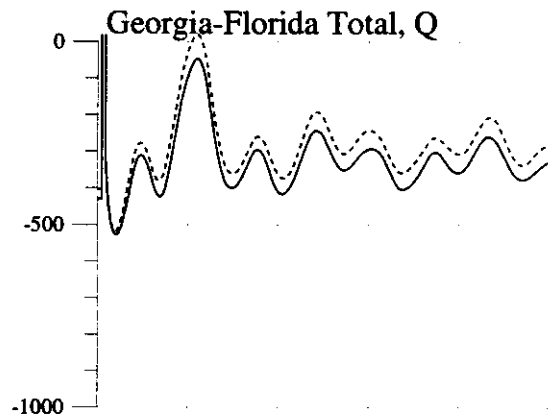
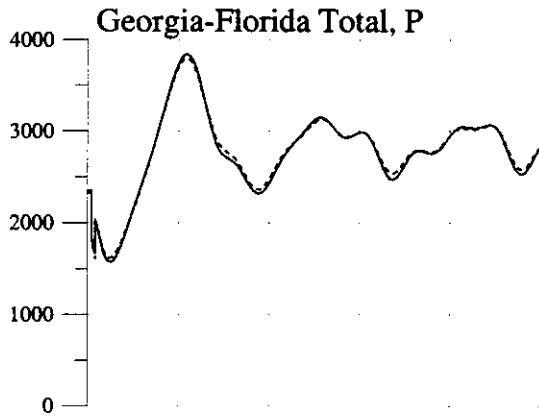

Time (Seconds)

Time (Seconds)



3-phase, 5-cycle Fault at Martin 500kV Bus, Trip Martin #2 & GSU
2003 Summer System

Machine Variables: (—) With Okeechobee JEA Dispatch, (...) Without

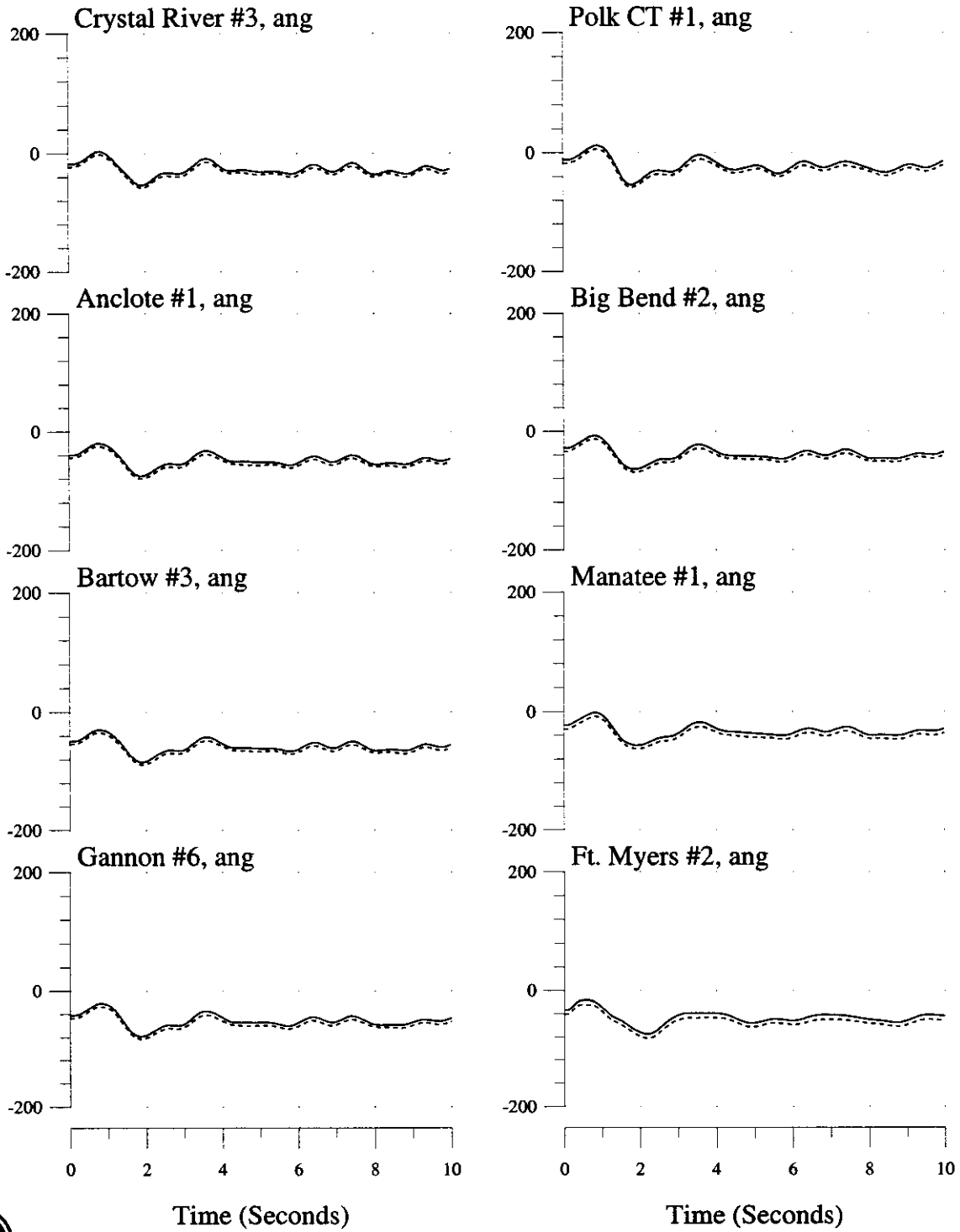

3-phase, 5-cycle Fault at Martin 500kV Bus, Trip Martin #2 & GSU
 2003 Summer System
 Machine Variables: (—) With Okeechobee JEA Dispatch, (...) Without

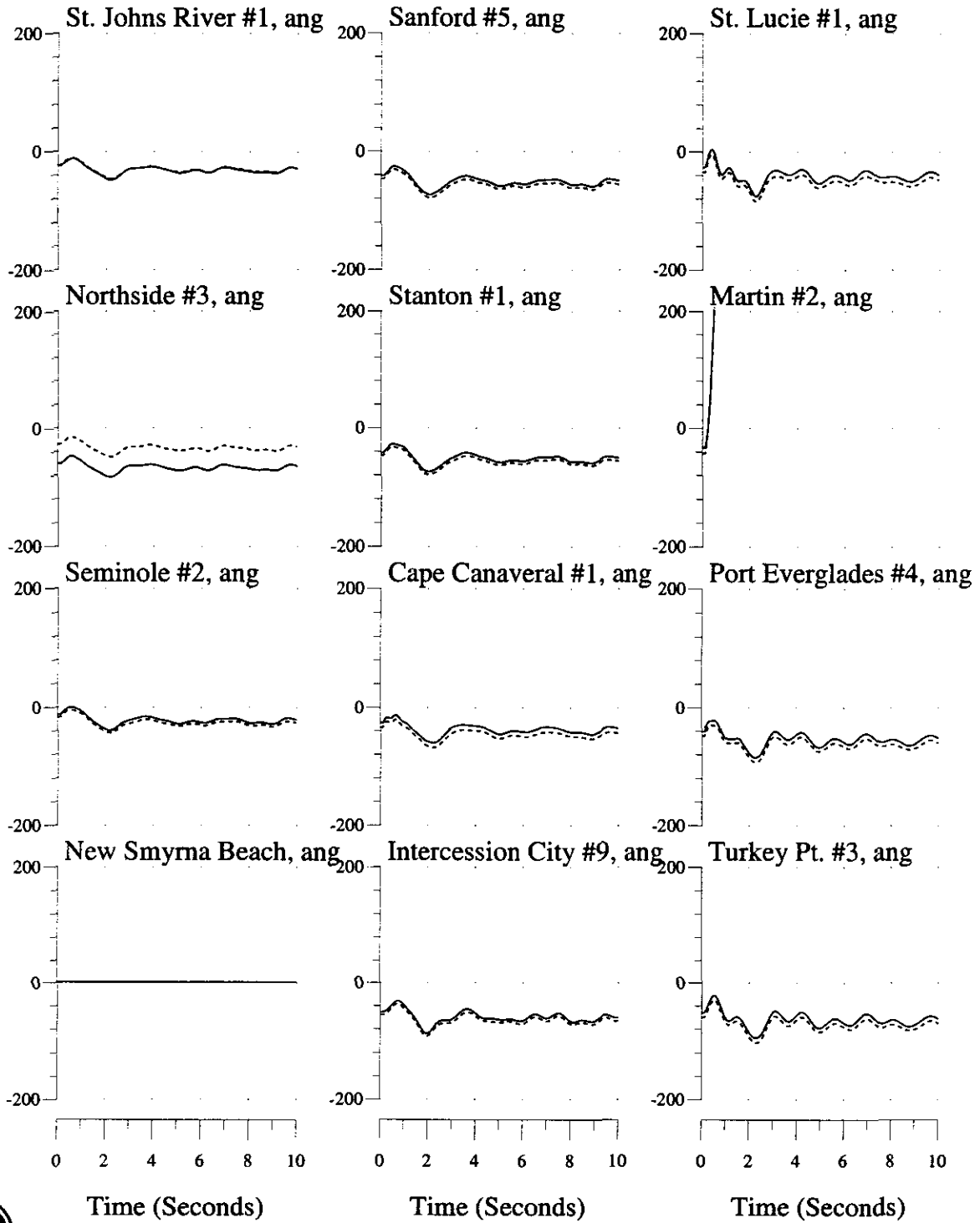

3-phase, 5-cycle Fault at Martin 500kV Bus, Trip Martin #2 & GSU
2003 Summer System

Bus Variables: (—) With Okeechobee JEA Dispatch, (...) Without

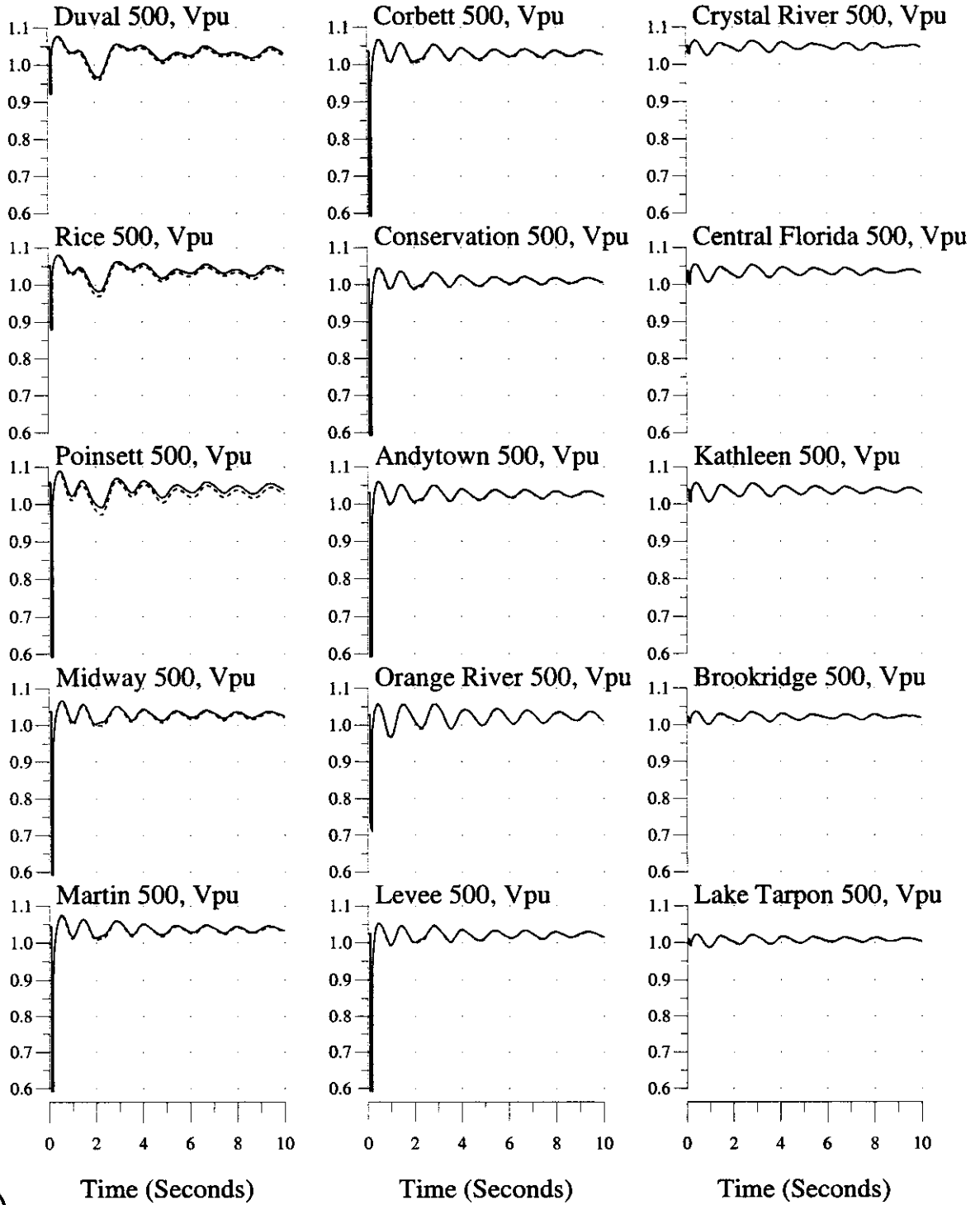

3-phase, 5-cycle Fault at Martin 500kV Bus, Trip Martin #2 & GSU
 2003 Summer System

Bus Variables: (—) With Okeechobee JEA Dispatch, (...) Without

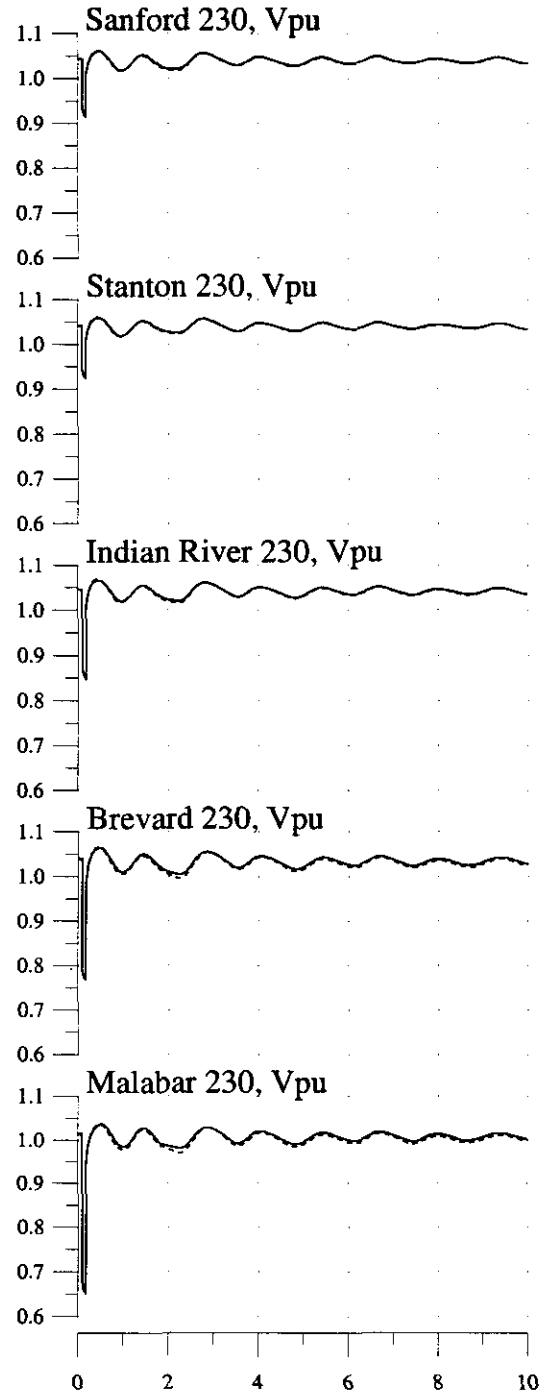
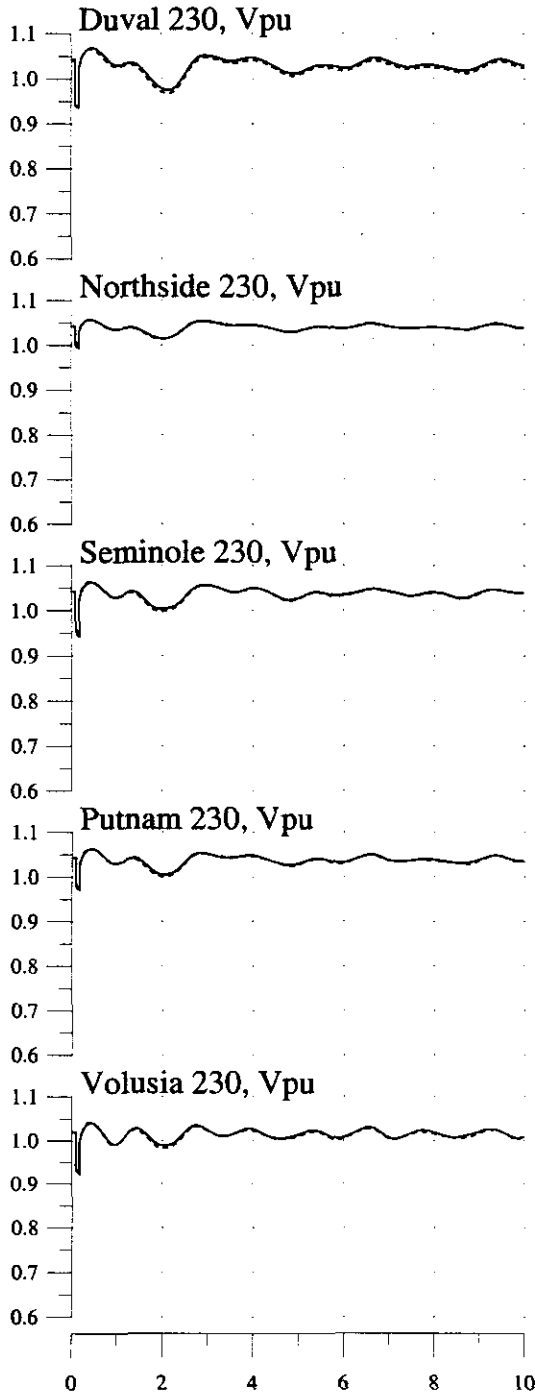

Time (Seconds)

Time (Seconds)



3-phase, 5-cycle Fault at Martin 500kV Bus, Trip Martin #2 & GSU
2003 Summer System

Bus Variables: (—) With Okeechobee JEA Dispatch, (...) Without

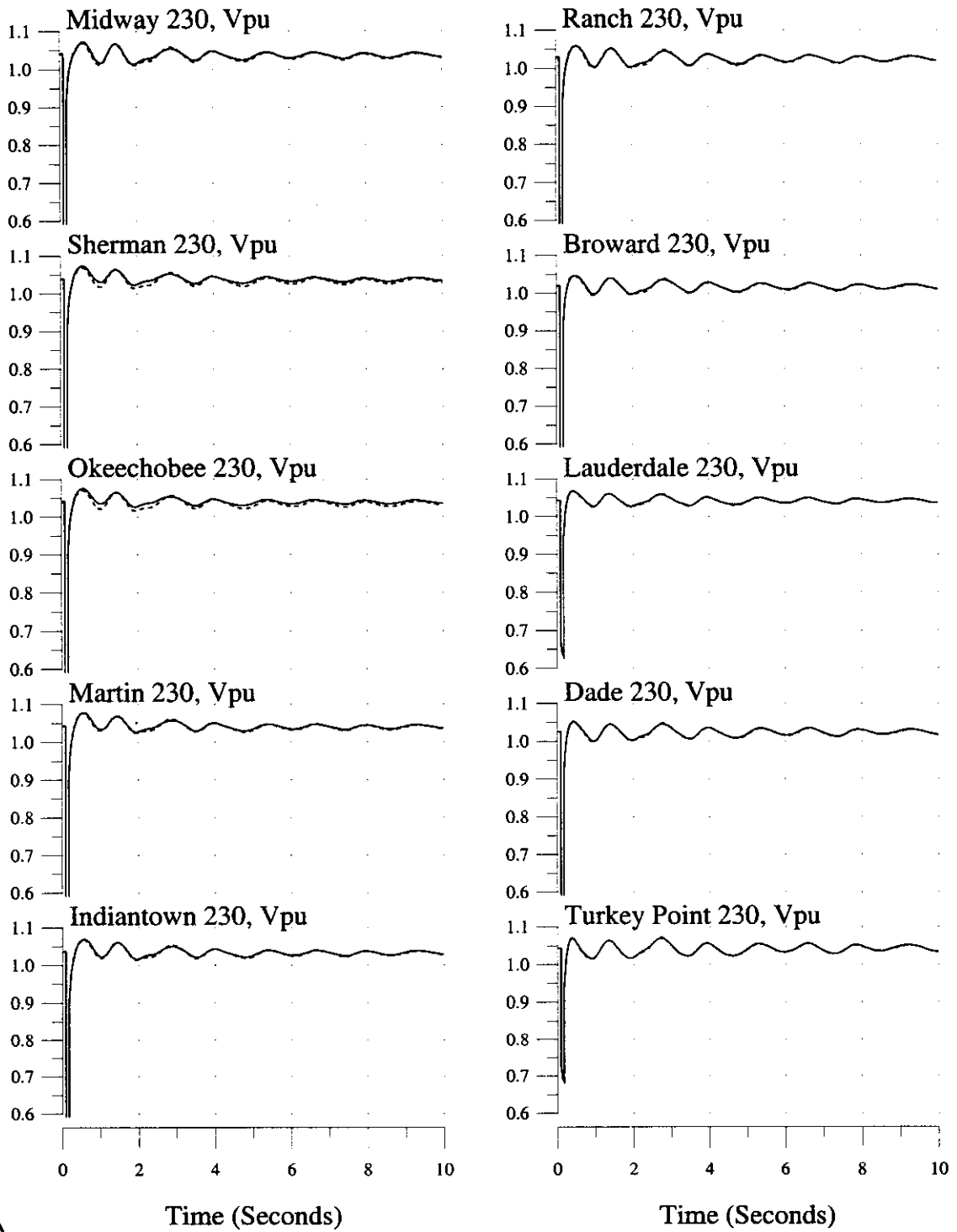

3-phase, 5-cycle Fault at Martin 500kV Bus, Trip Martin #2 & GSU
2003 Summer System

Bus Variables: (—) With Okeechobee JEA Dispatch, (...) Without

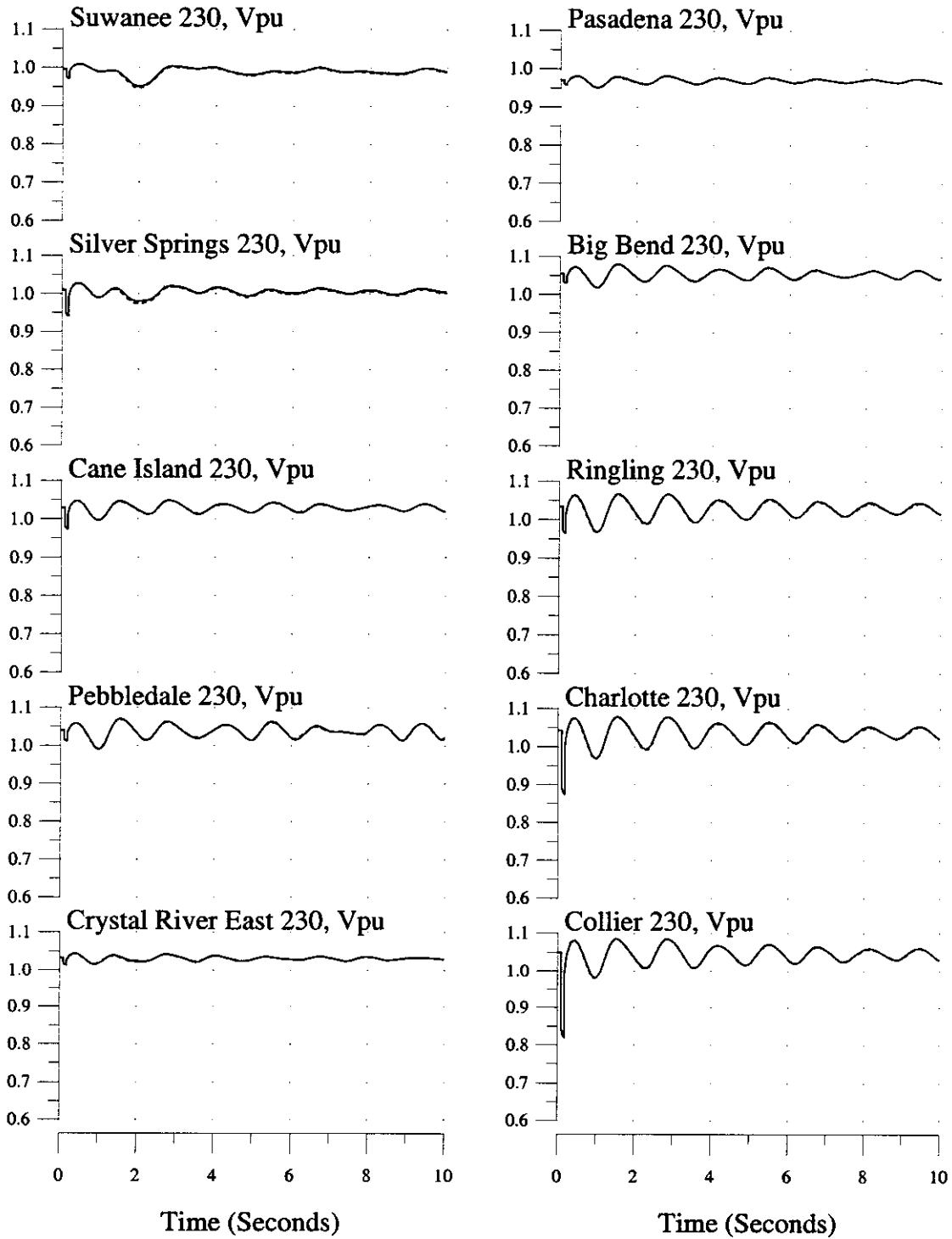

3-phase, 5-cycle Fault at Duval 500kV Bus, Trip Thalmann-Duval 500kV Line
 2003 Summer System
 Machine & Interface Variables: (___) With Okeechobee JEA Dispatch, (...) Without

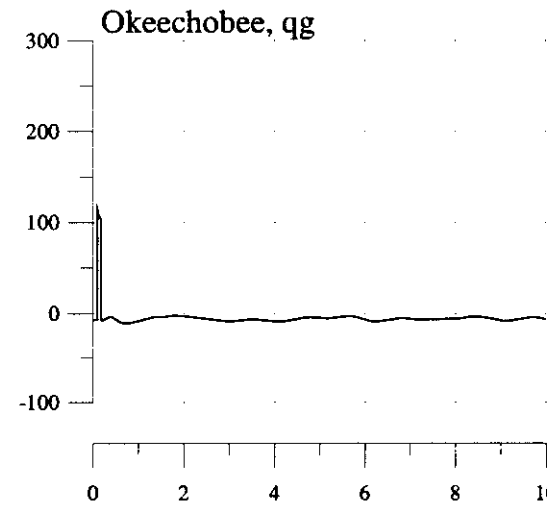
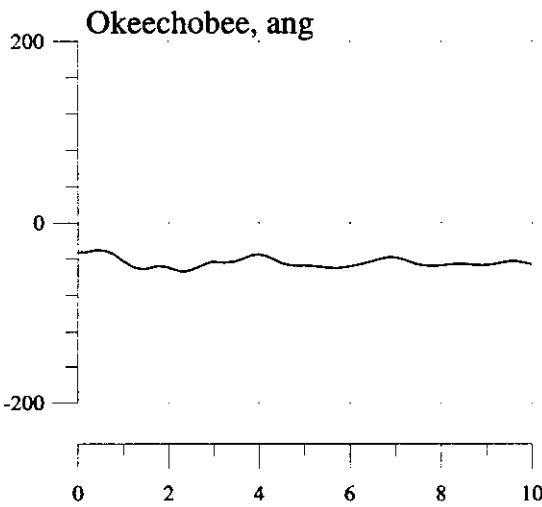
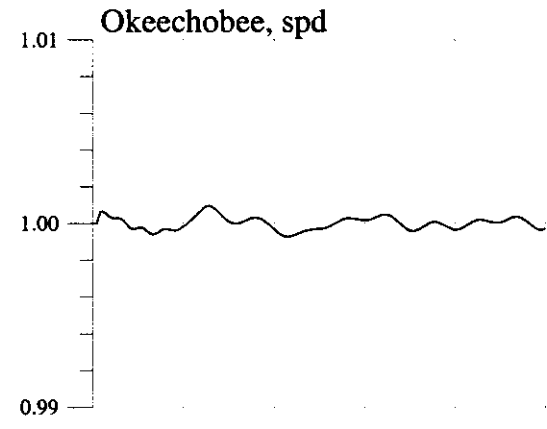
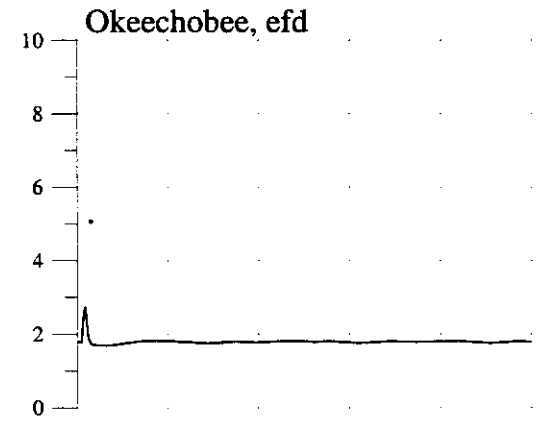
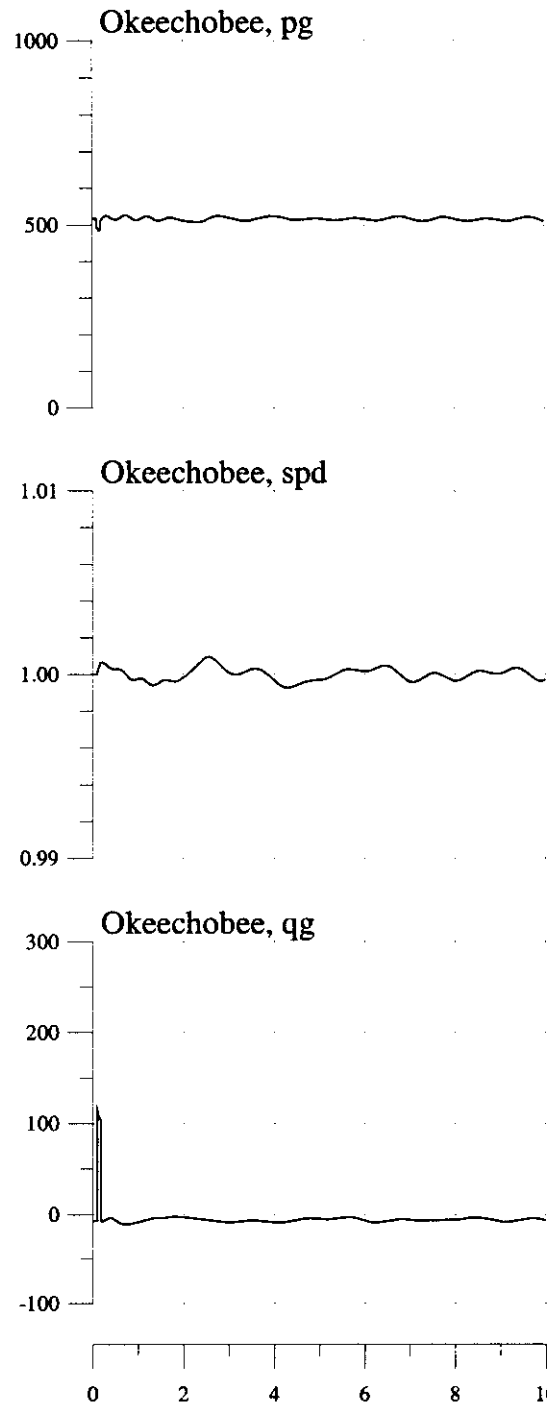
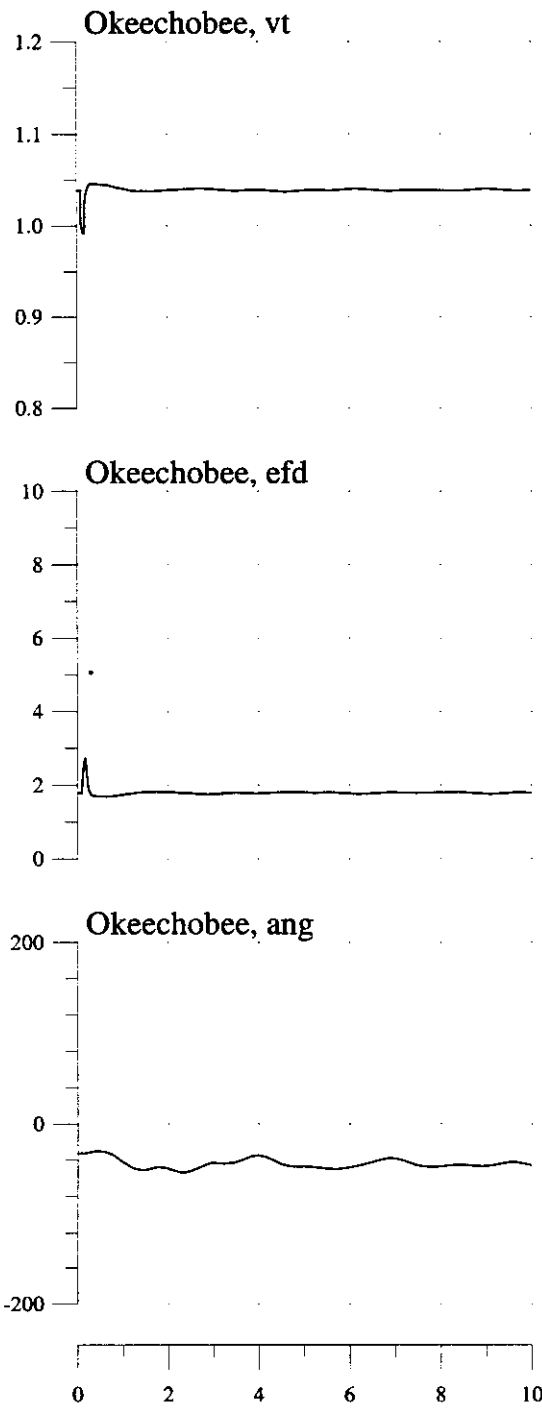

3-phase, 5-cycle Fault at Duval 500kV Bus, Trip Thalmann-Duval 500kV Line
2003 Summer System

Machine & Interface Variables: (—) With Okeechobee JEA Dispatch, (...) Without

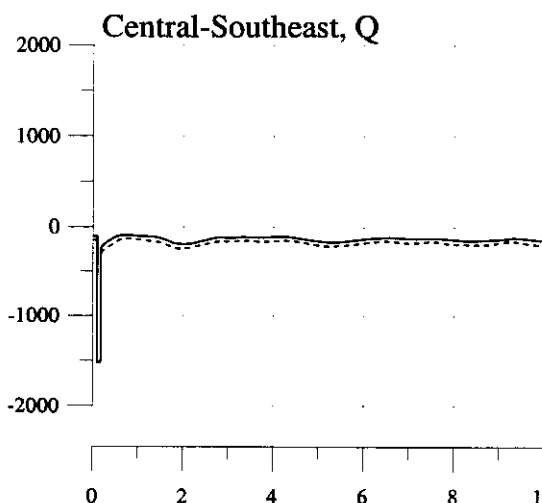
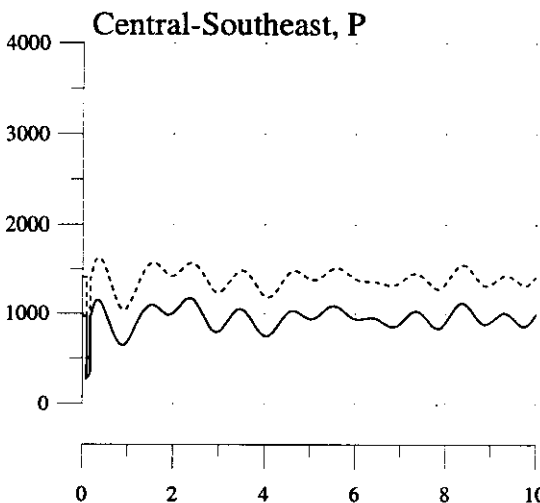
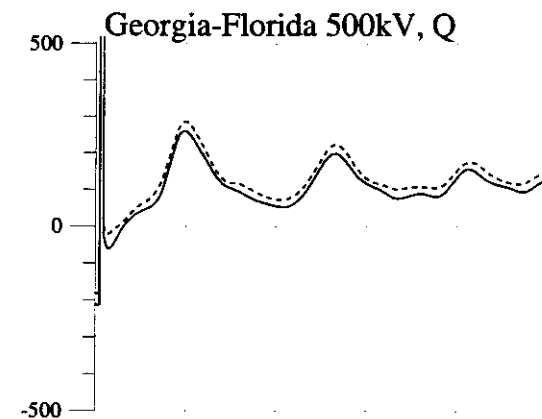
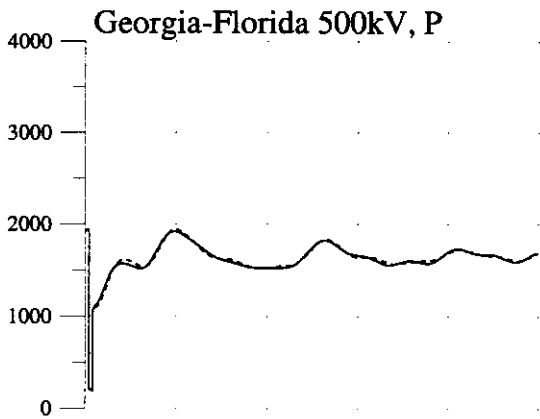
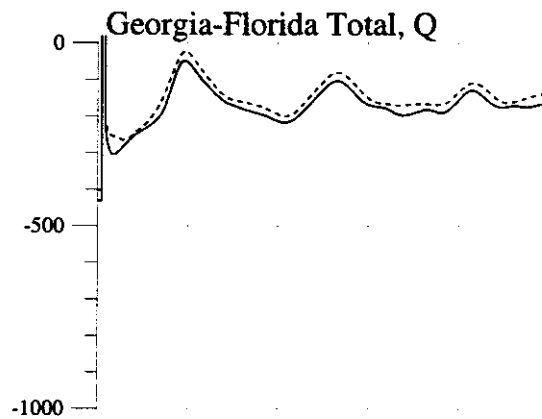
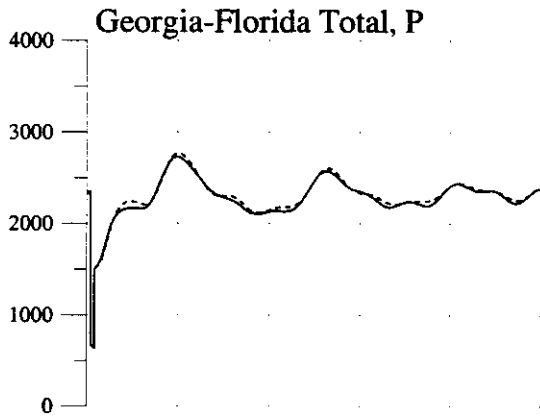

Time (Seconds)

Time (Seconds)



3-phase, 5-cycle Fault at Duval 500kV Bus, Trip Thalmann-Duval 500kV Line
2003 Summer System

Machine Variables: (—) With Okeechobee JEA Dispatch, (...) Without

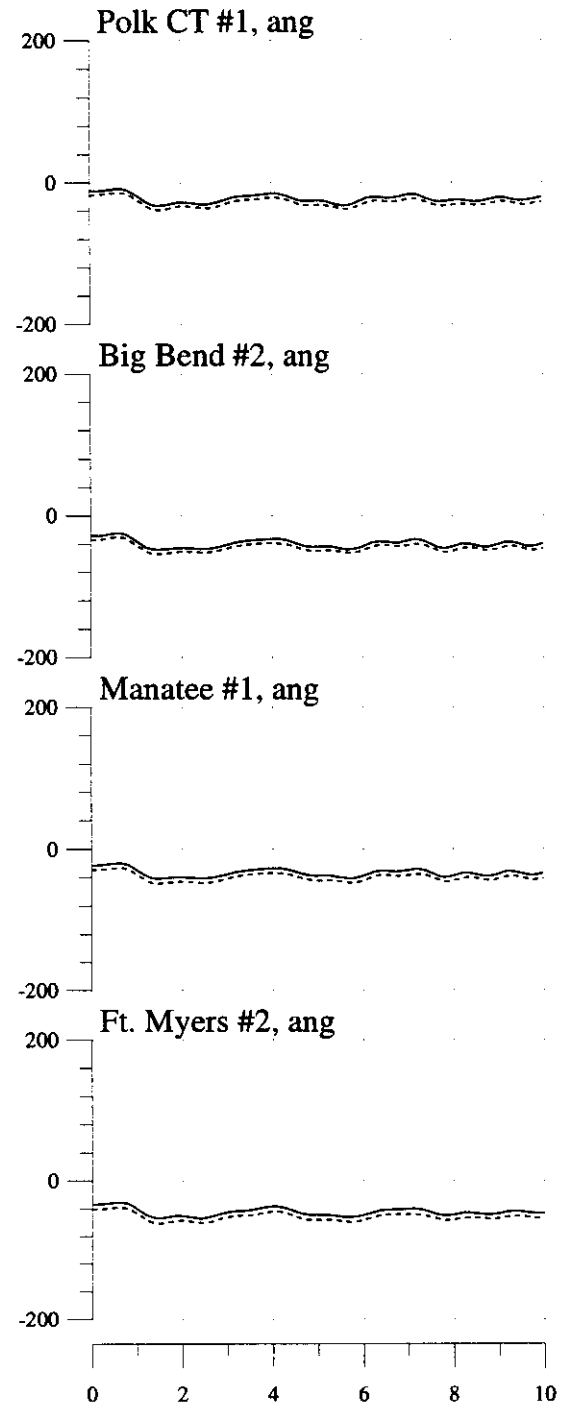
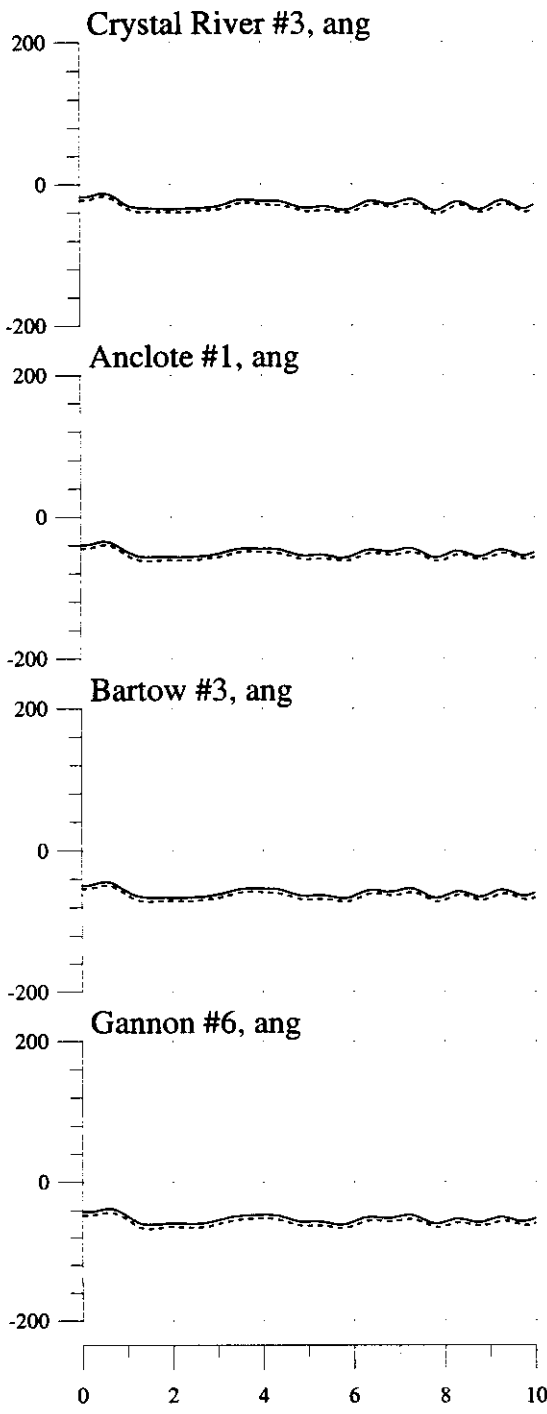

3-phase, 5-cycle Fault at Duval 500kV Bus, Trip Thalmann-Duval 500kV Line
2003 Summer System

Machine Variables: (—) With Okeechobee JEA Dispatch, (...) Without

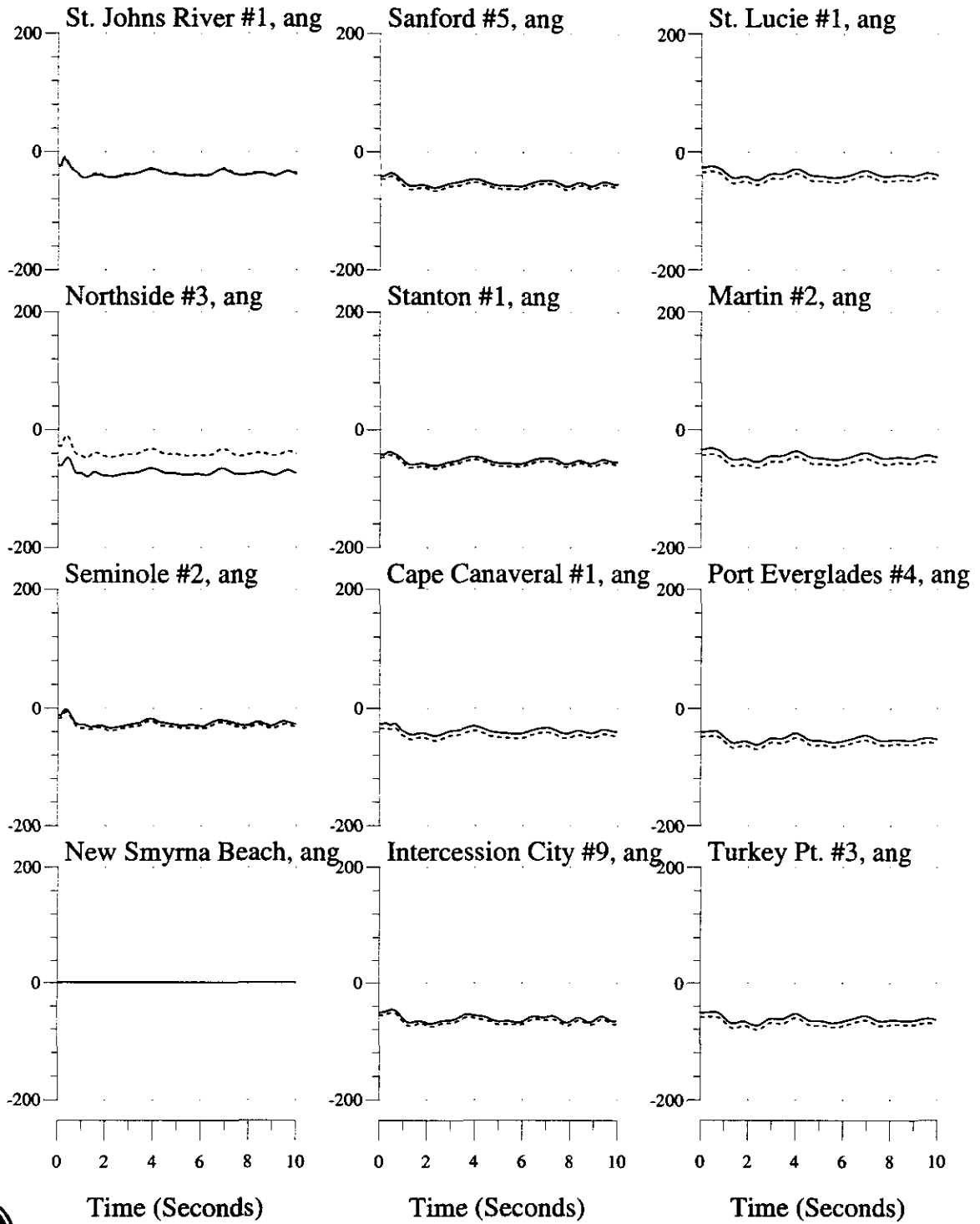

3-phase, 5-cycle Fault at Duval 500kV Bus, Trip Thalmann-Duval 500kV Line
 2003 Summer System

Bus Variables: (—) With Okeechobee JEA Dispatch, (...) Without

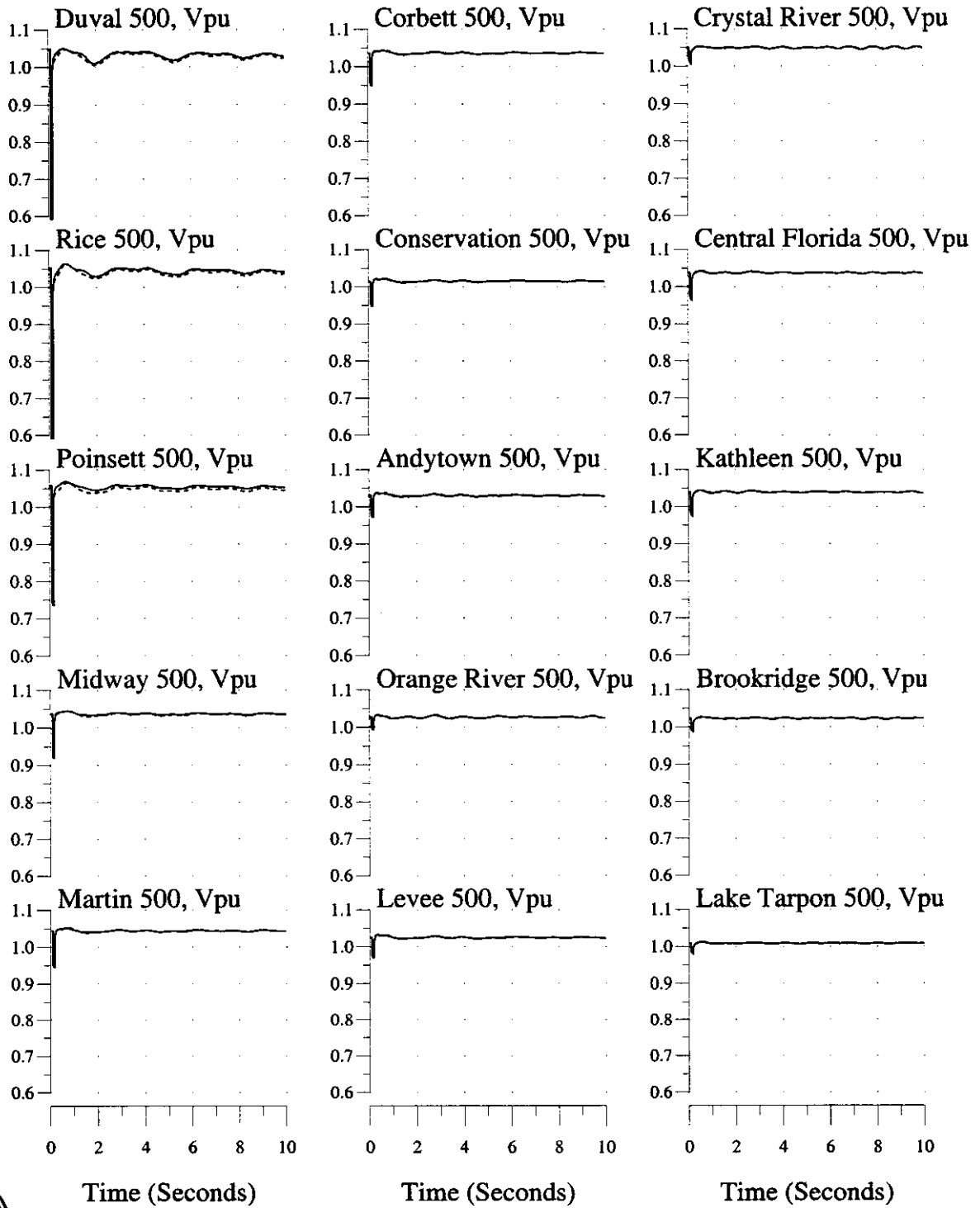

3-phase, 5-cycle Fault at Duval 500kV Bus, Trip Thalmann-Duval 500kV Line
2003 Summer System

Bus Variables: (—) With Okeechobee JEA Dispatch, (...) Without

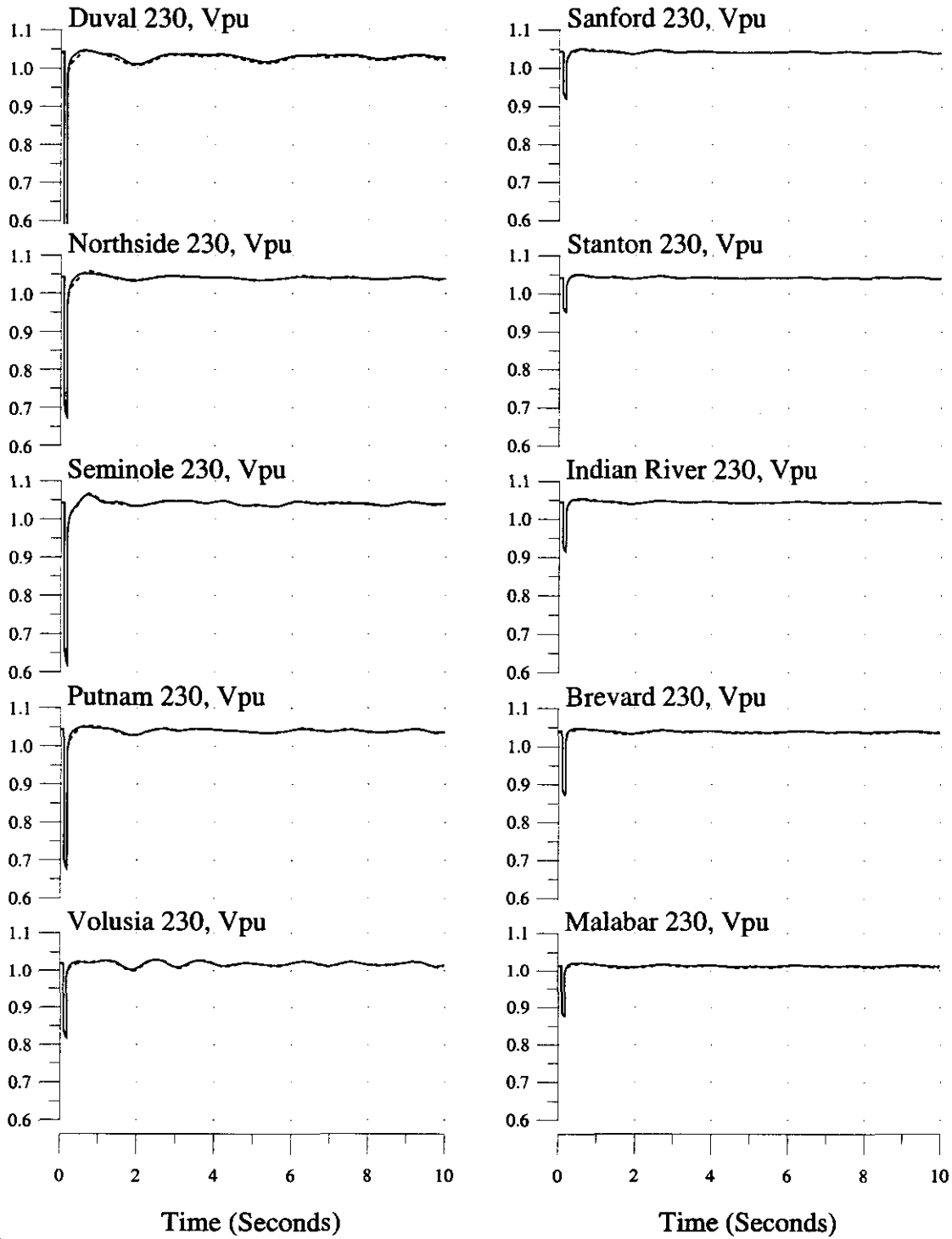

3-phase, 5-cycle Fault at Duval 500kV Bus, Trip Thalmann-Duval 500kV Line
2003 Summer System

Bus Variables: (—) With Okeechobee JEA Dispatch, (...) Without

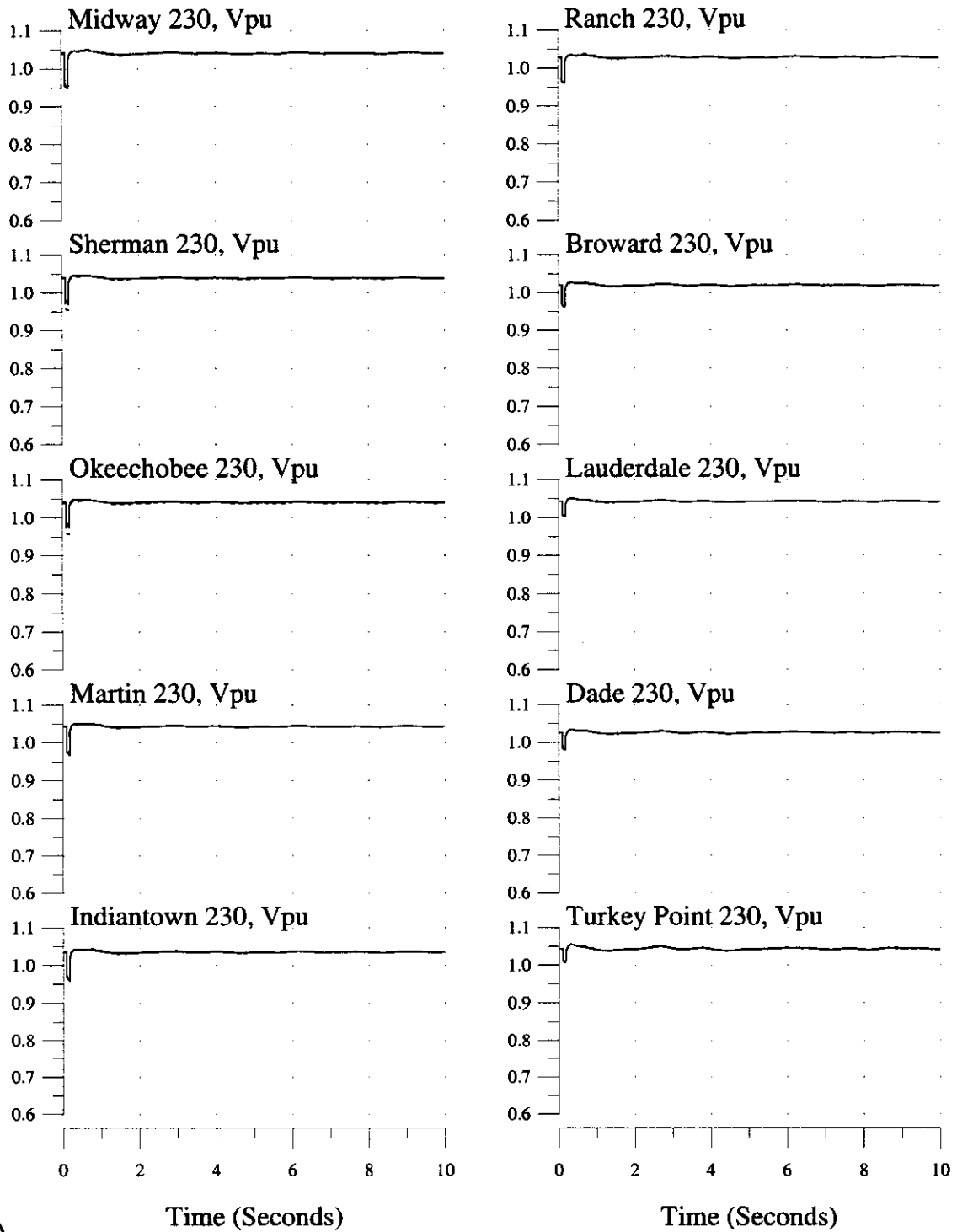

3-phase, 5-cycle Fault at Duval 500kV Bus, Trip Thalmann-Duval 500kV Line
2003 Summer System

Bus Variables: (___) With Okeechobee JEA Dispatch, (...) Without

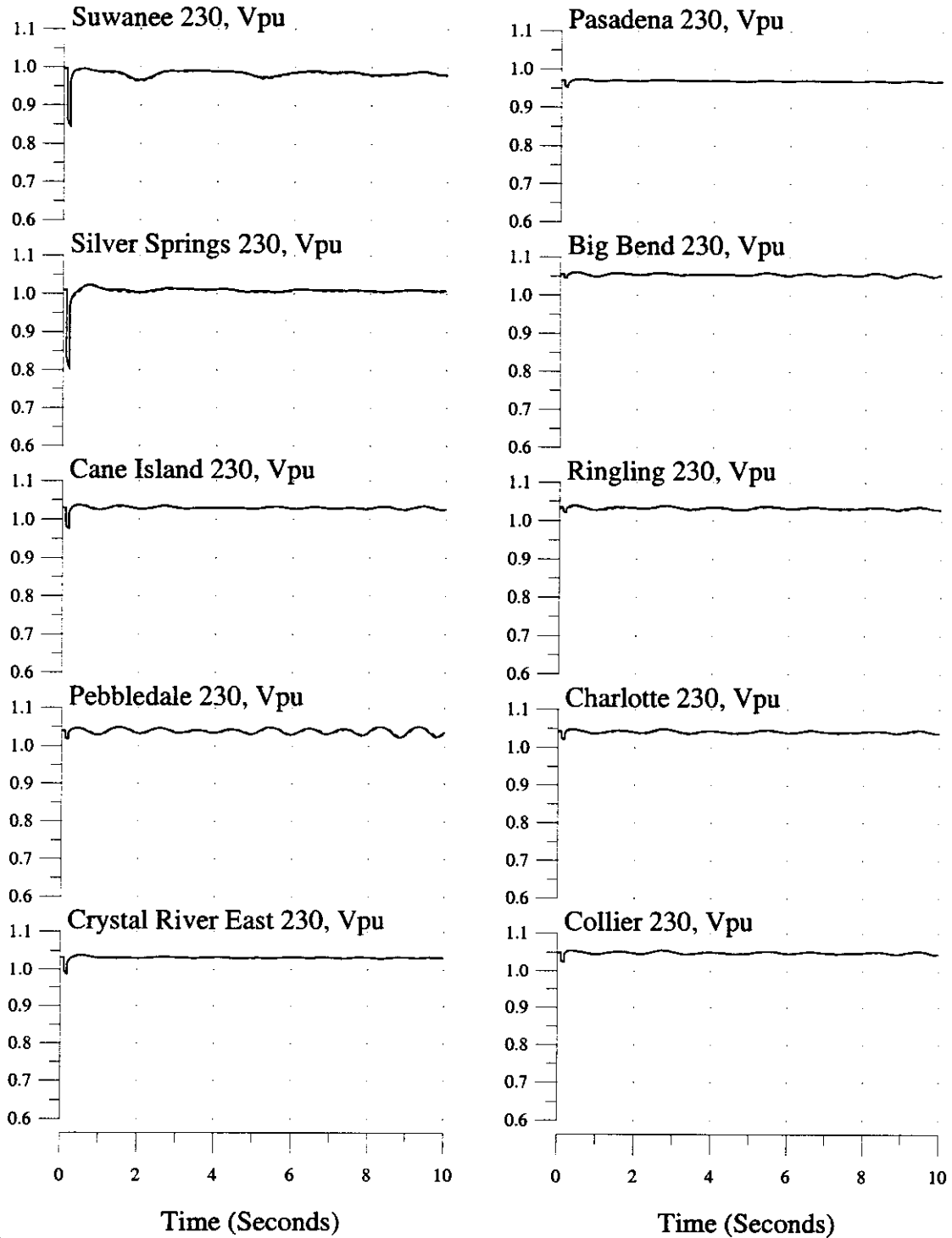

3-phase, 5-cycle Fault at Martin 500kV Bus, Trip Poinsett-Martin 500kV Line
 2003 Summer System
 Machine & Interface Variables: (—) With Okeechobee JEA Dispatch, (...) Without

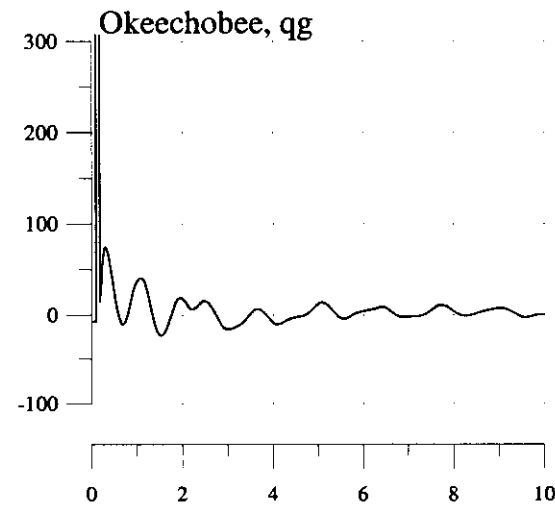
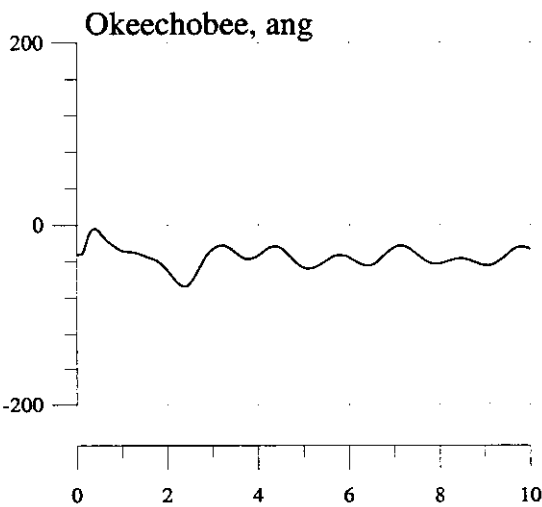
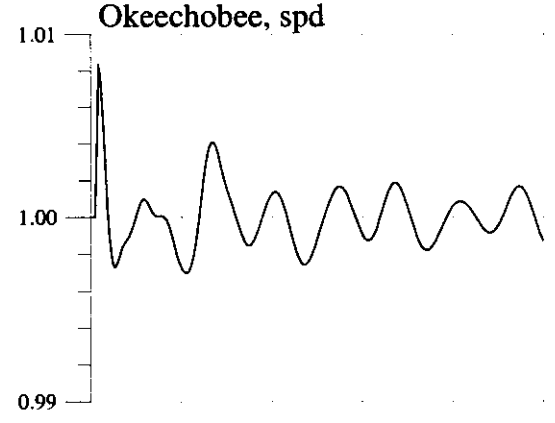
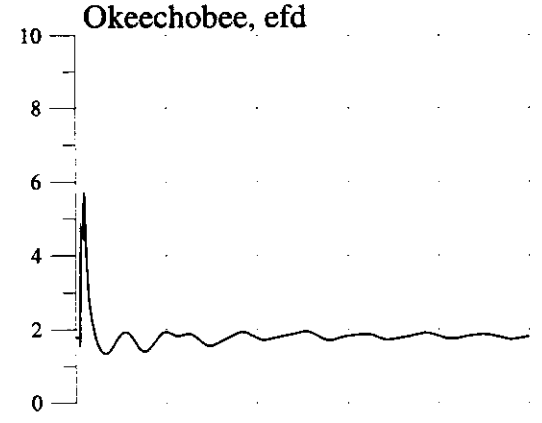
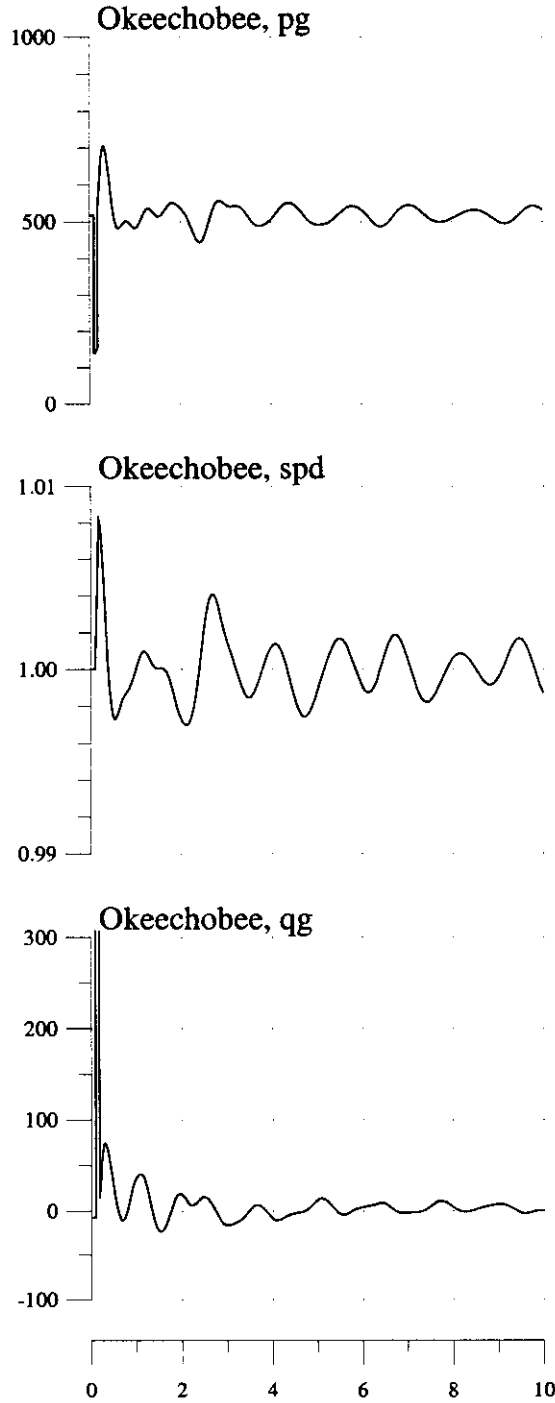
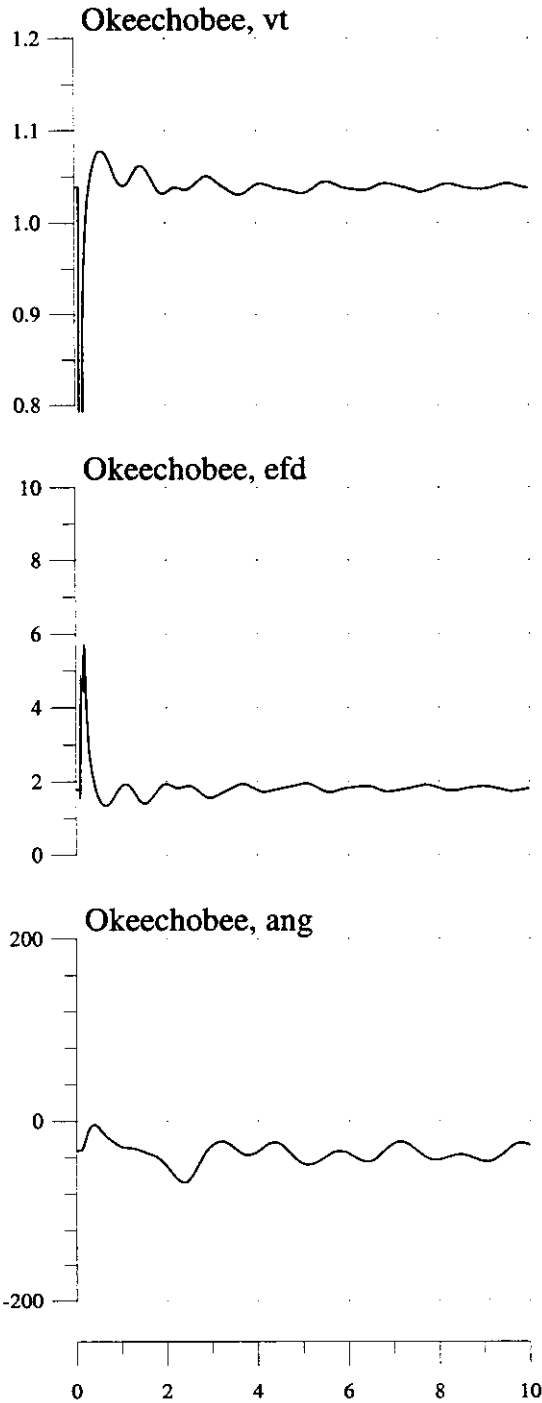

Time (Seconds)

Time (Seconds)



3-phase, 5-cycle Fault at Martin 500kV Bus, Trip Poinsett-Martin 500kV Line
 2003 Summer System
 Machine & Interface Variables: (—) With Okeechobee JEA Dispatch, (...) Without

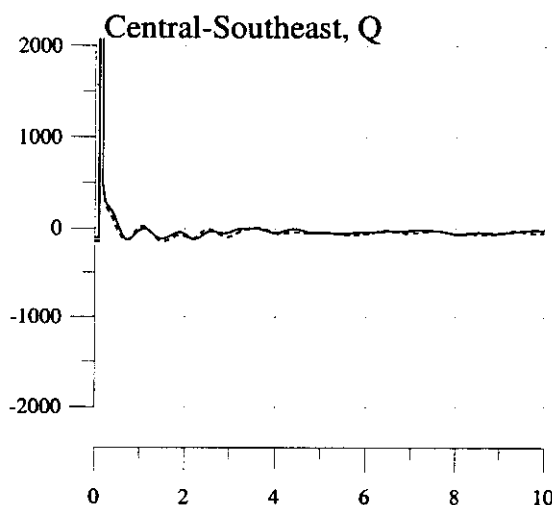
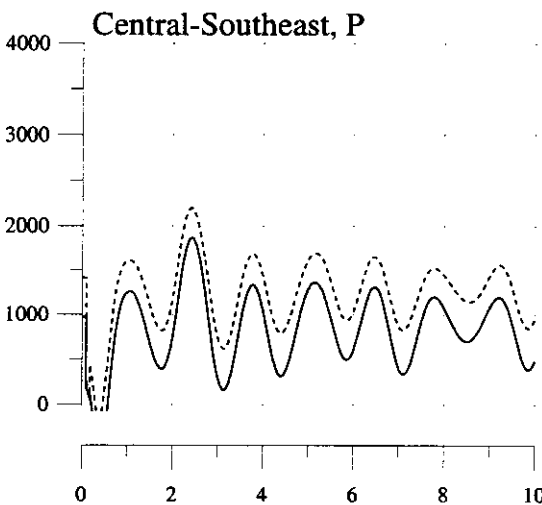
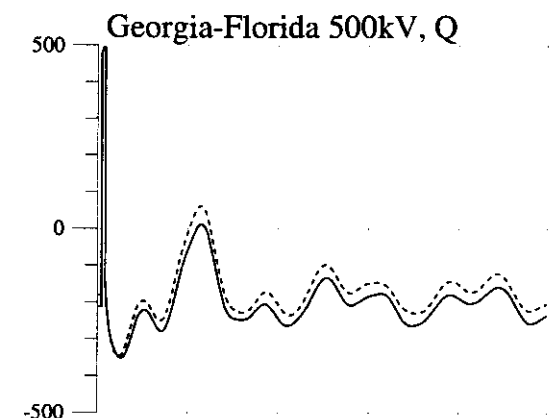
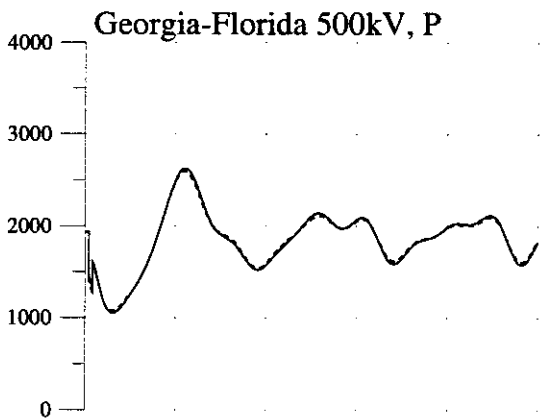
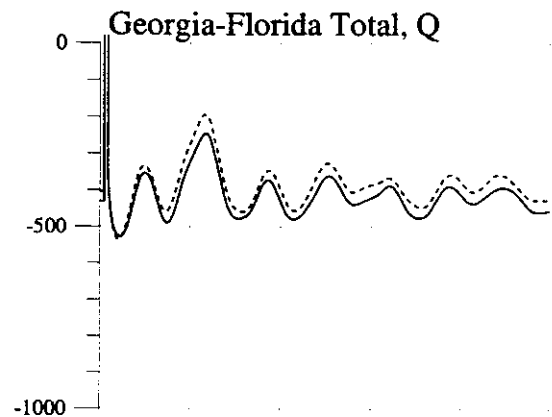
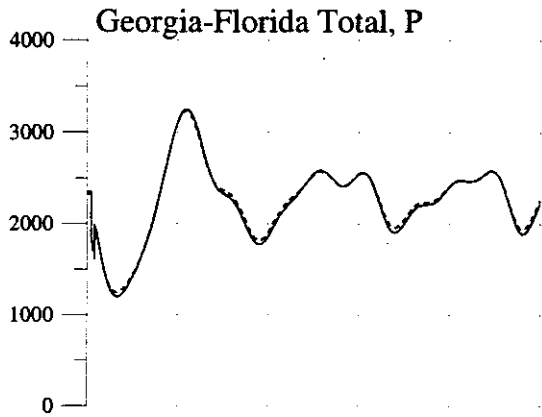

Time (Seconds)

Time (Seconds)



3-phase, 5-cycle Fault at Martin 500kV Bus, Trip Poinsett-Martin 500kV Line
2003 Summer System

Machine Variables: (—) With Okeechobee JEA Dispatch, (...) Without

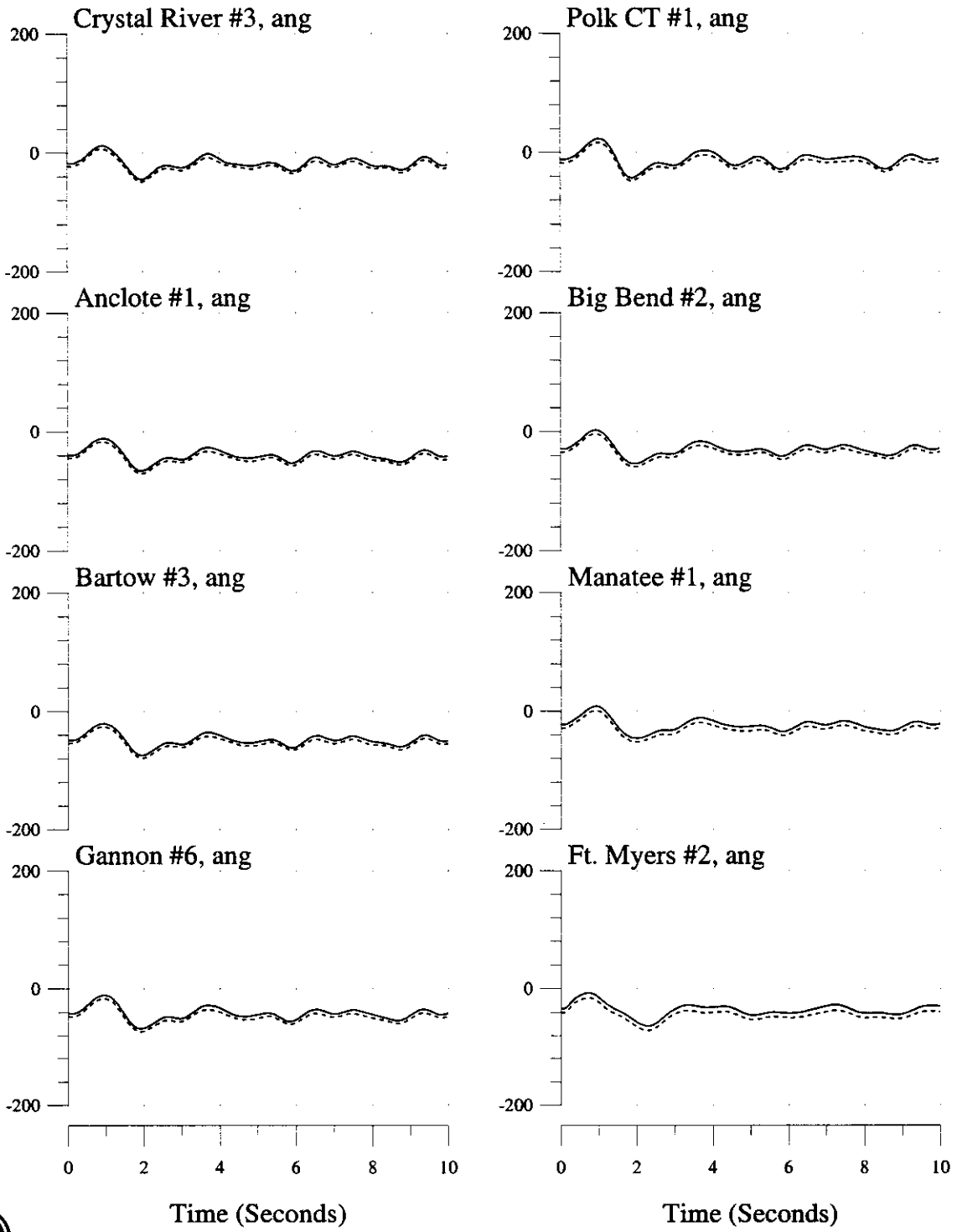

3-phase, 5-cycle Fault at Martin 500kV Bus, Trip Poinsett-Martin 500kV Line
 2003 Summer System

Machine Variables: (—) With Okeechobee JEA Dispatch, (...) Without

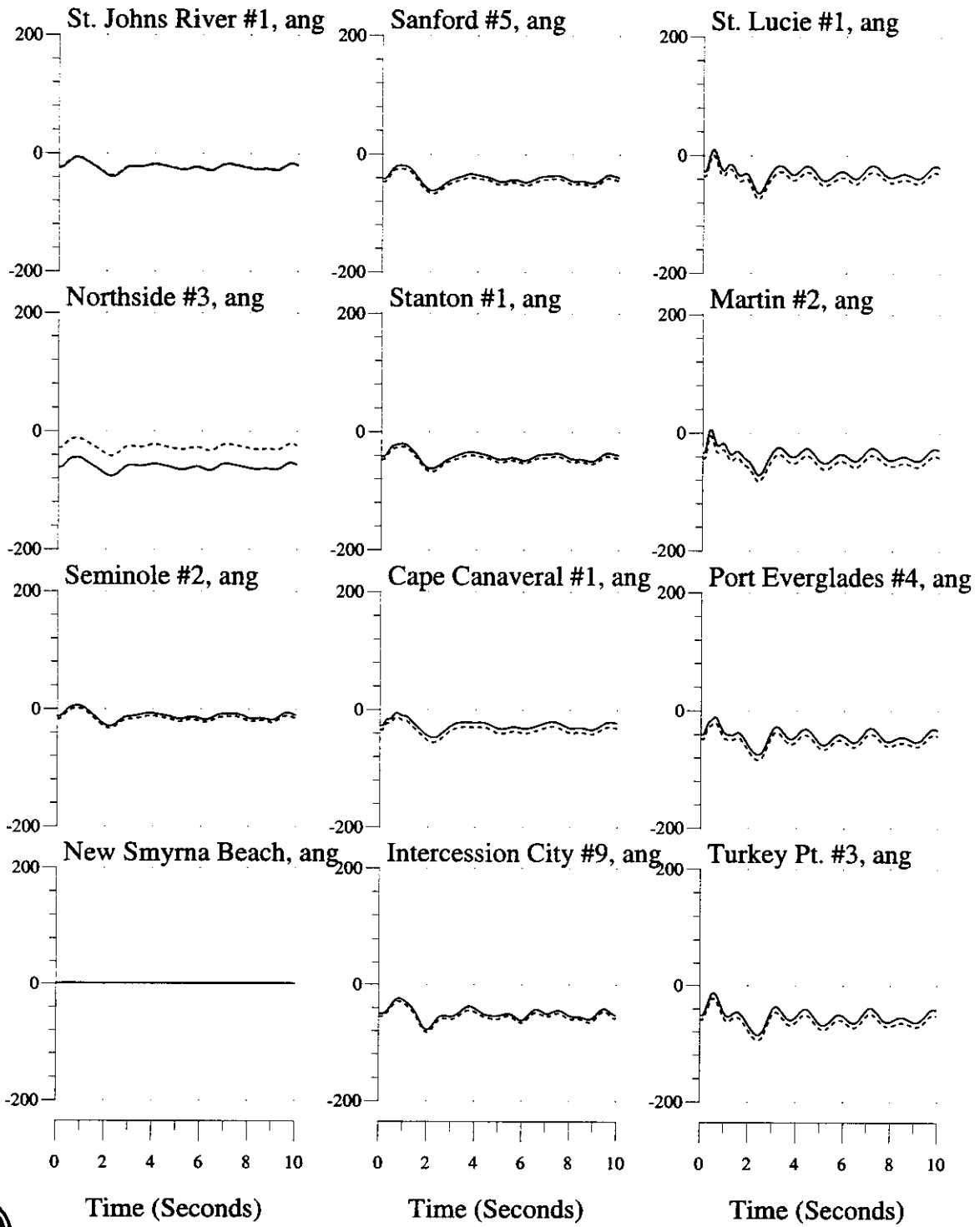

3-phase, 5-cycle Fault at Martin 500kV Bus, Trip Poinsett-Martin 500kV Line
 2003 Summer System

Bus Variables: (—) With Okeechobee JEA Dispatch, (...) Without

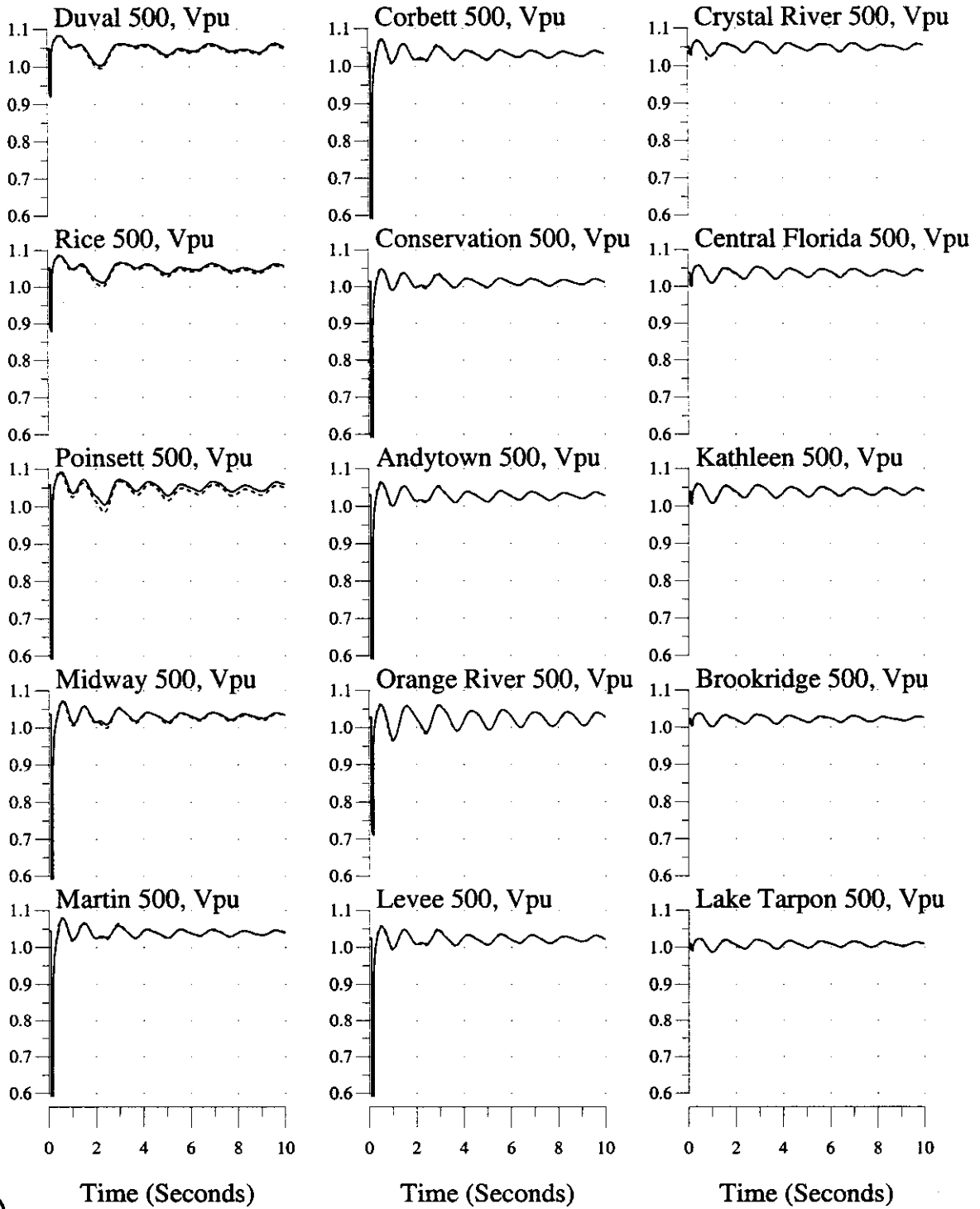

3-phase, 5-cycle Fault at Martin 500kV Bus, Trip Poinsett-Martin 500kV Line
2003 Summer System

Bus Variables: (—) With Okeechobee JEA Dispatch, (...) Without

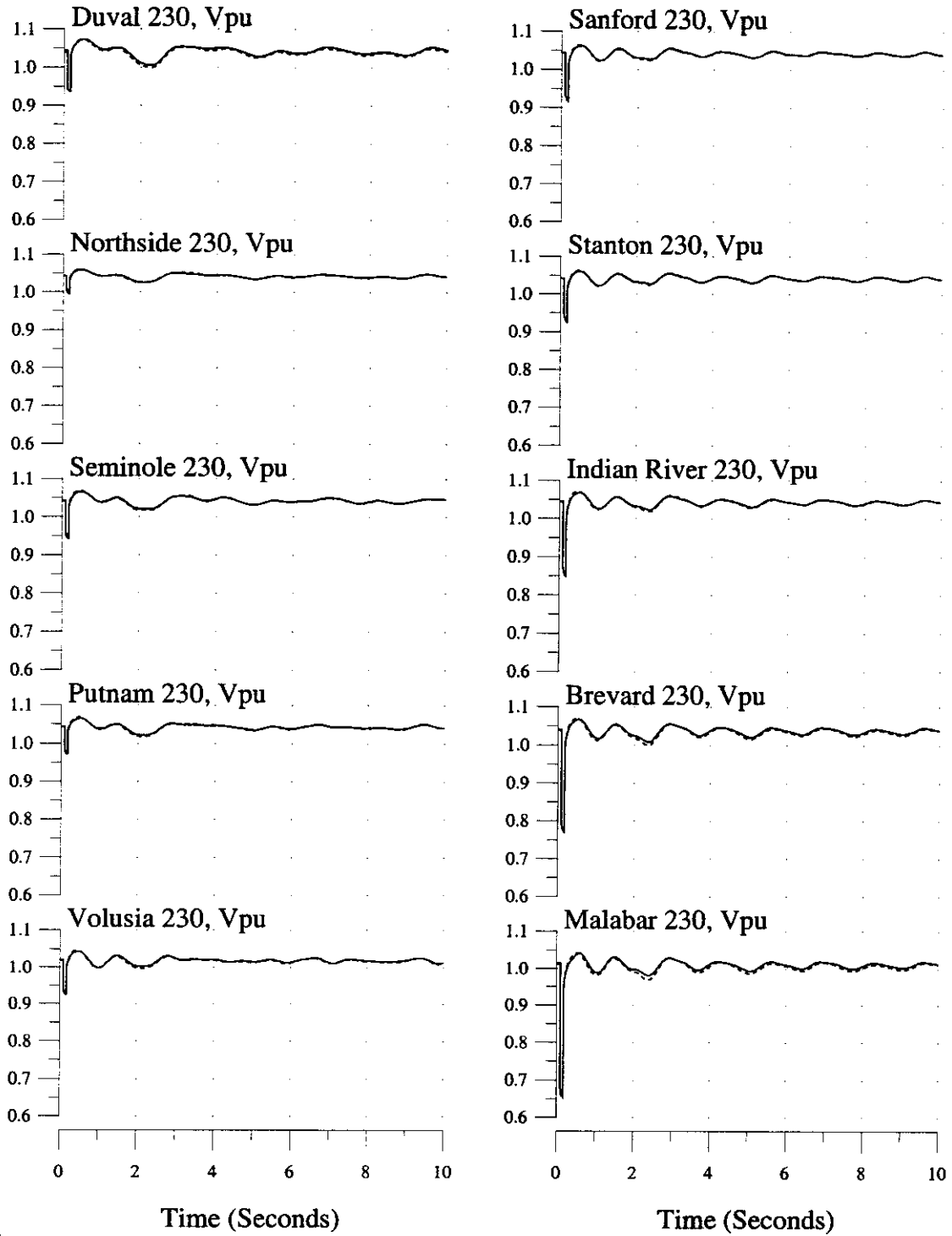

3-phase, 5-cycle Fault at Martin 500kV Bus, Trip Poinsett-Martin 500kV Line
2003 Summer System

Bus Variables: (___) With Okeechobee JEA Dispatch, (...) Without

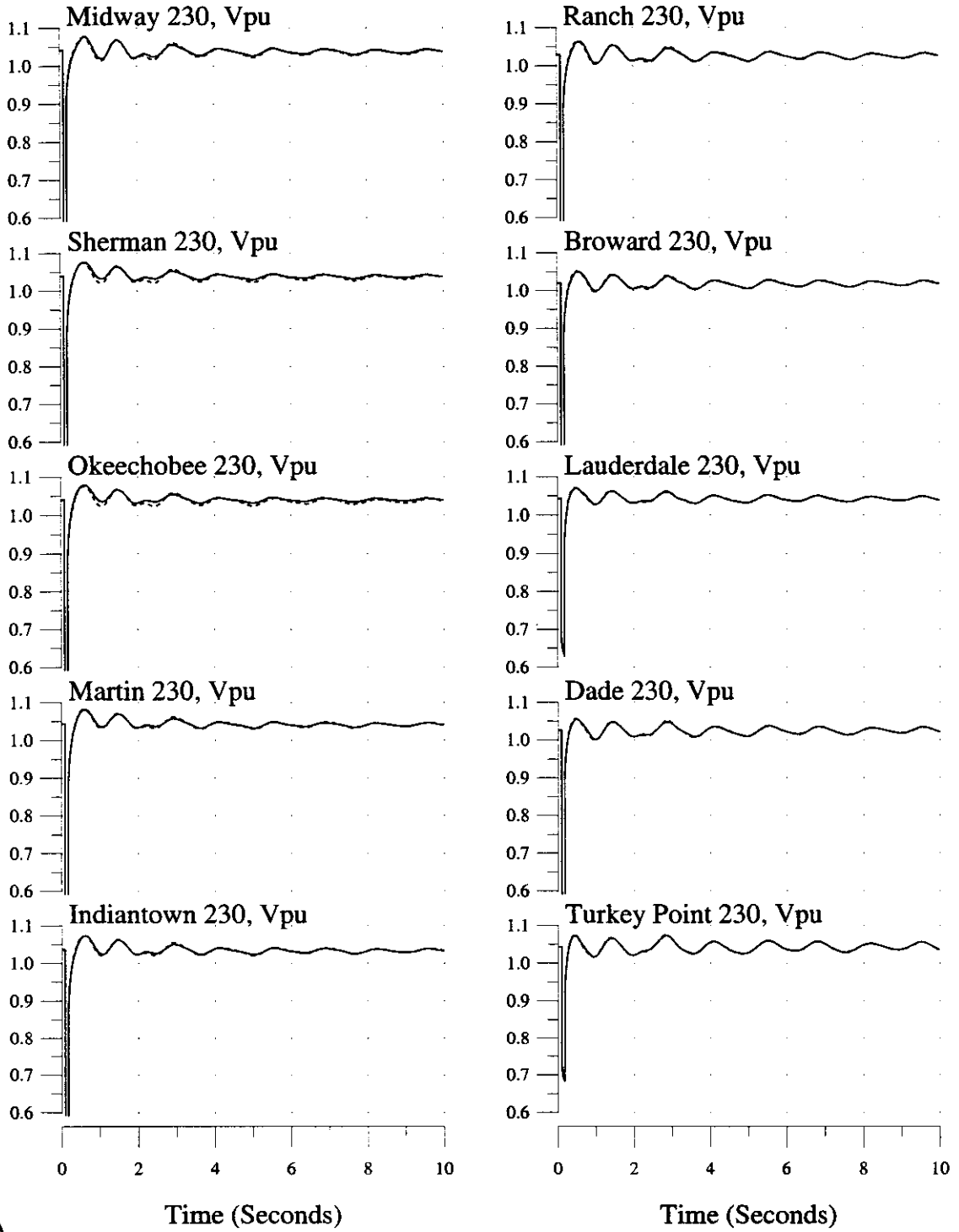

3-phase, 5-cycle Fault at Martin 500kV Bus, Trip Poinsett-Martin 500kV Line
2003 Summer System

Bus Variables: (—) With Okeechobee JEA Dispatch, (...) Without

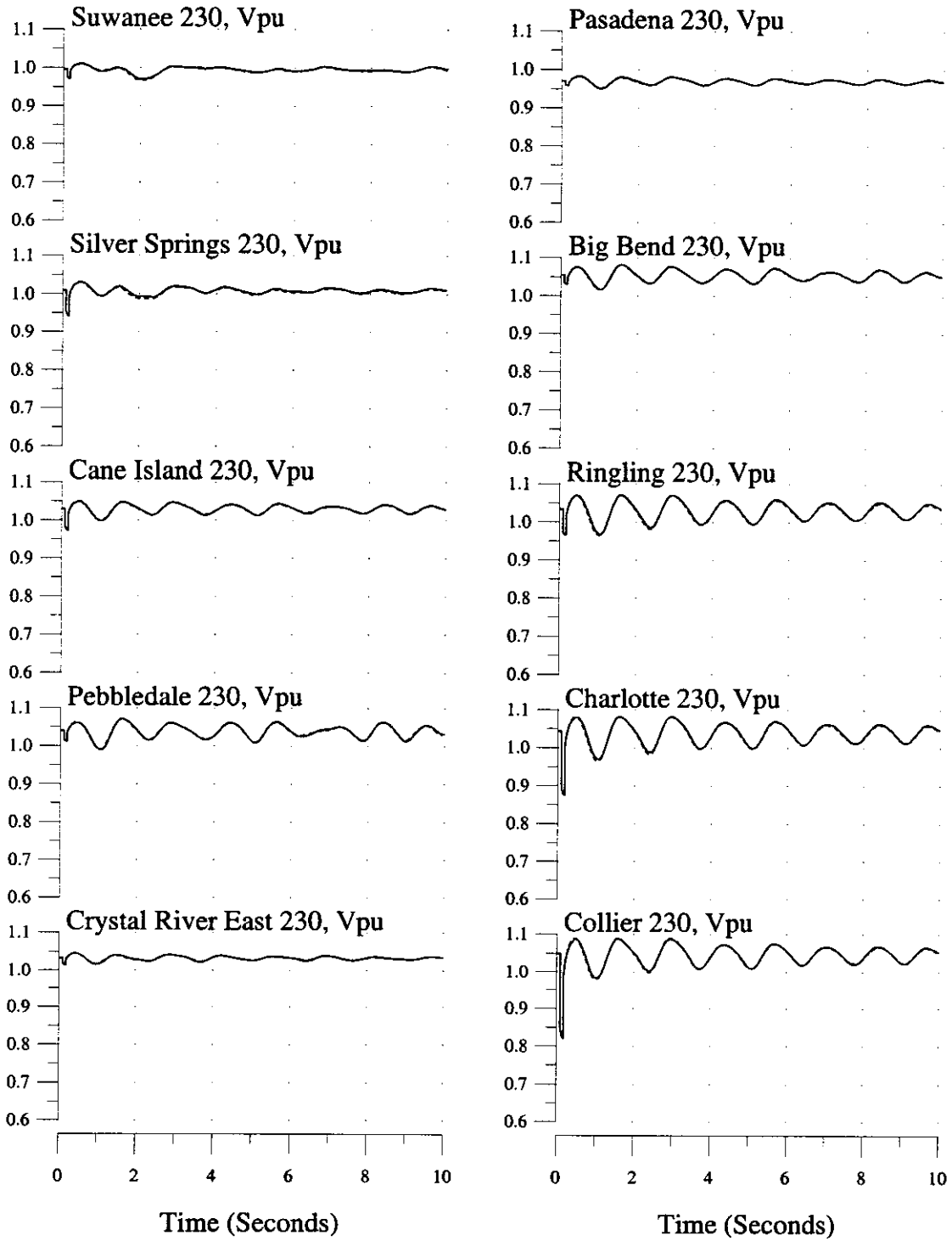

3-phase, 5-cycle Fault at Okeechobee 230kV Bus, Trip Okeechobee-Sherman 230kV Line 2003 Summer System

Machine & Interface Variables: (—) With Okeechobee JEA Dispatch, (...) Without

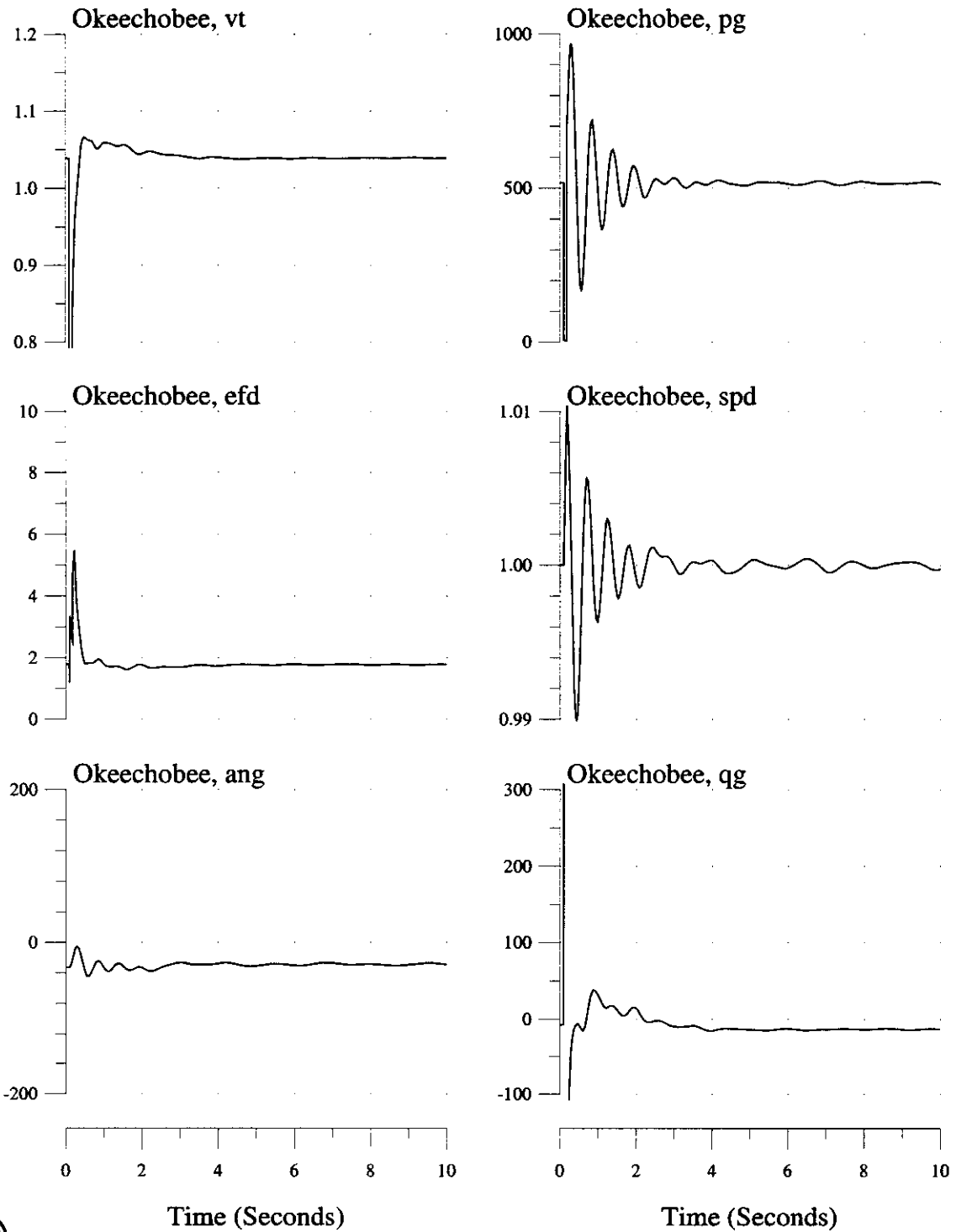

3-phase, 5-cycle Fault at Okeechobee 230kV Bus, Trip Okeechobee-Sherman 230kV Line
2003 Summer System

Machine & Interface Variables: (___) With Okeechobee JEA Dispatch, (...) Without

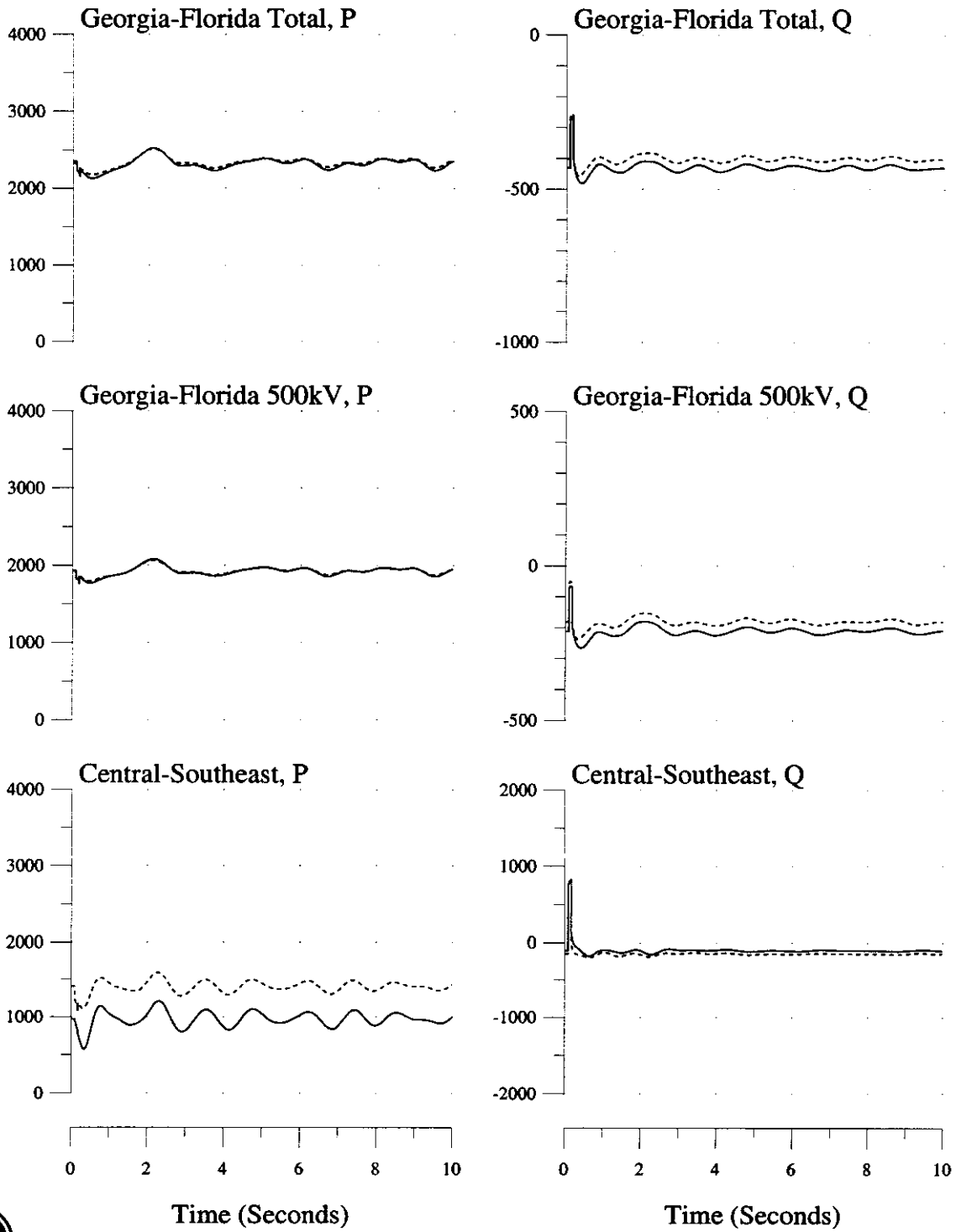

3-phase, 5-cycle Fault at Okeechobee 230kV Bus, Trip Okeechobee-Sherman 230kV Line
2003 Summer System

Machine Variables: (___) With Okeechobee JEA Dispatch, (...) Without

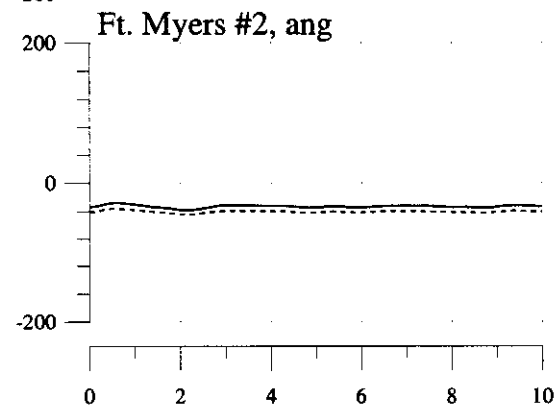
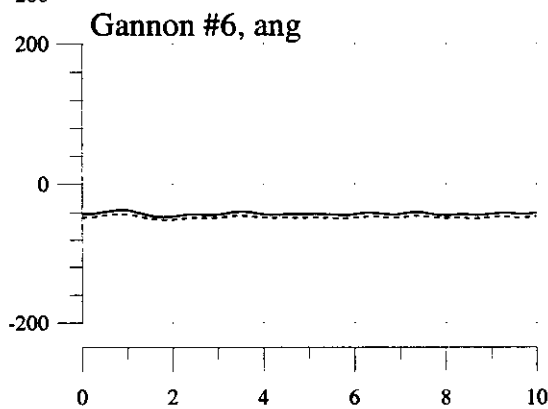
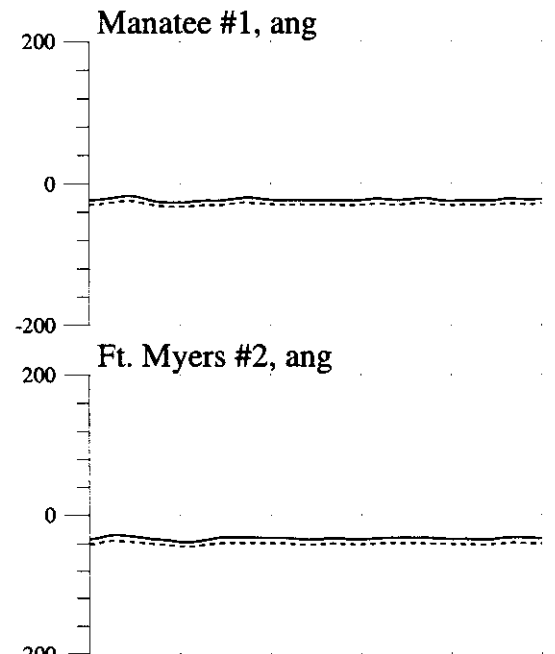
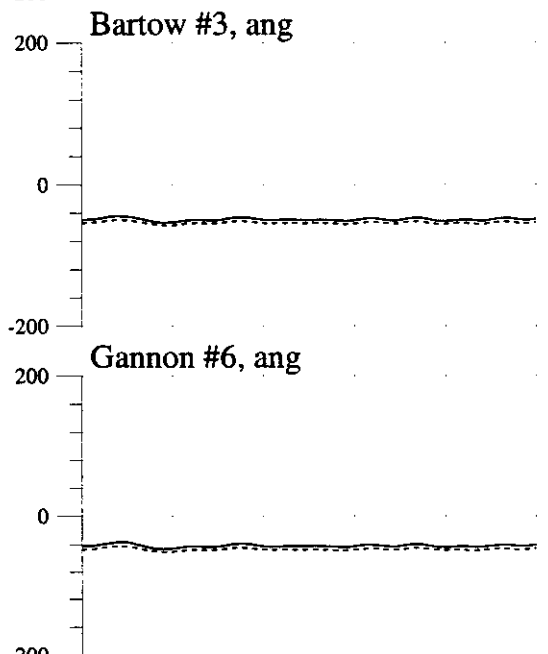
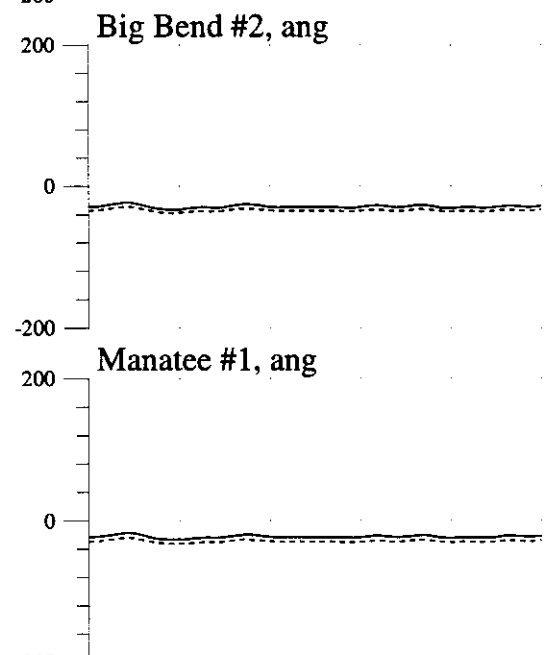
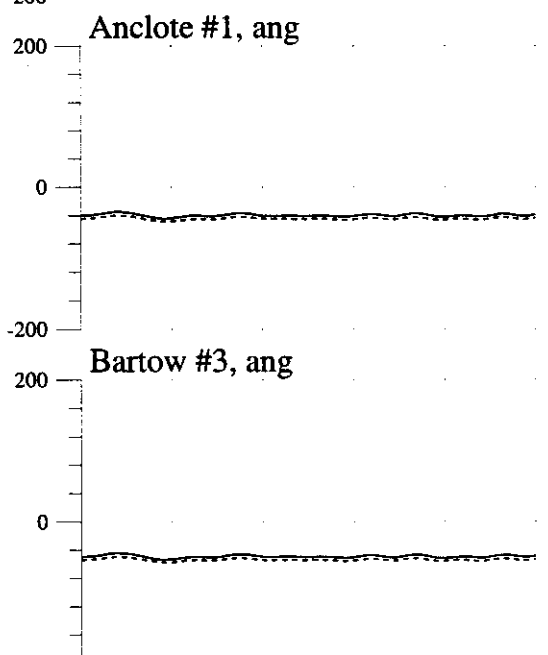
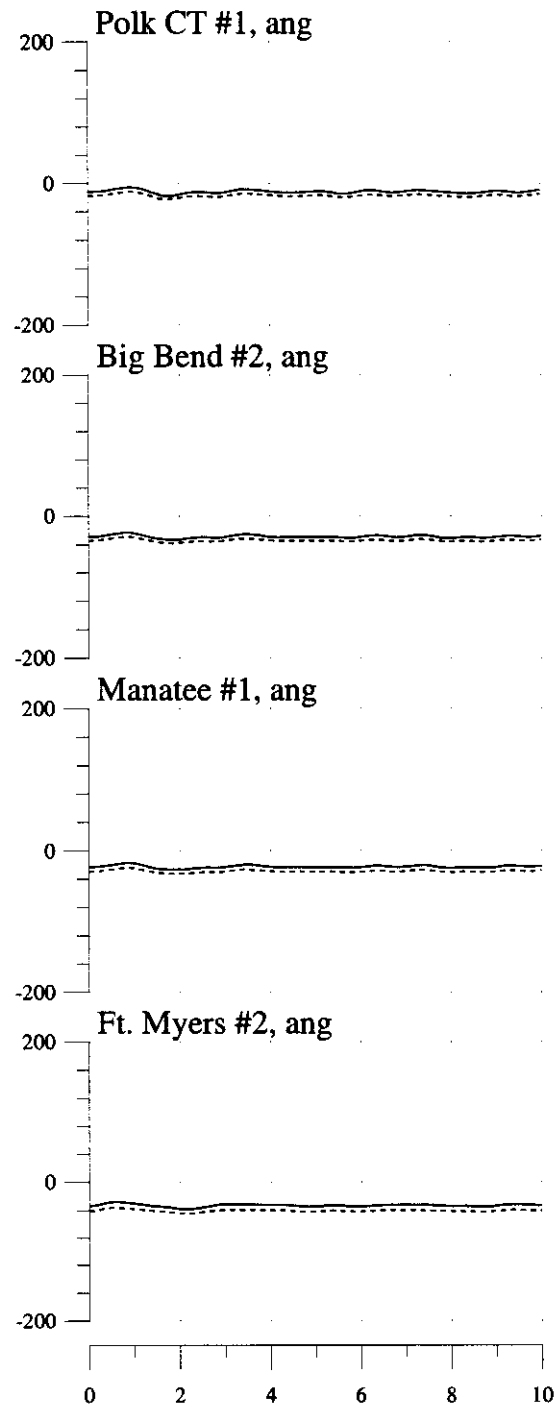
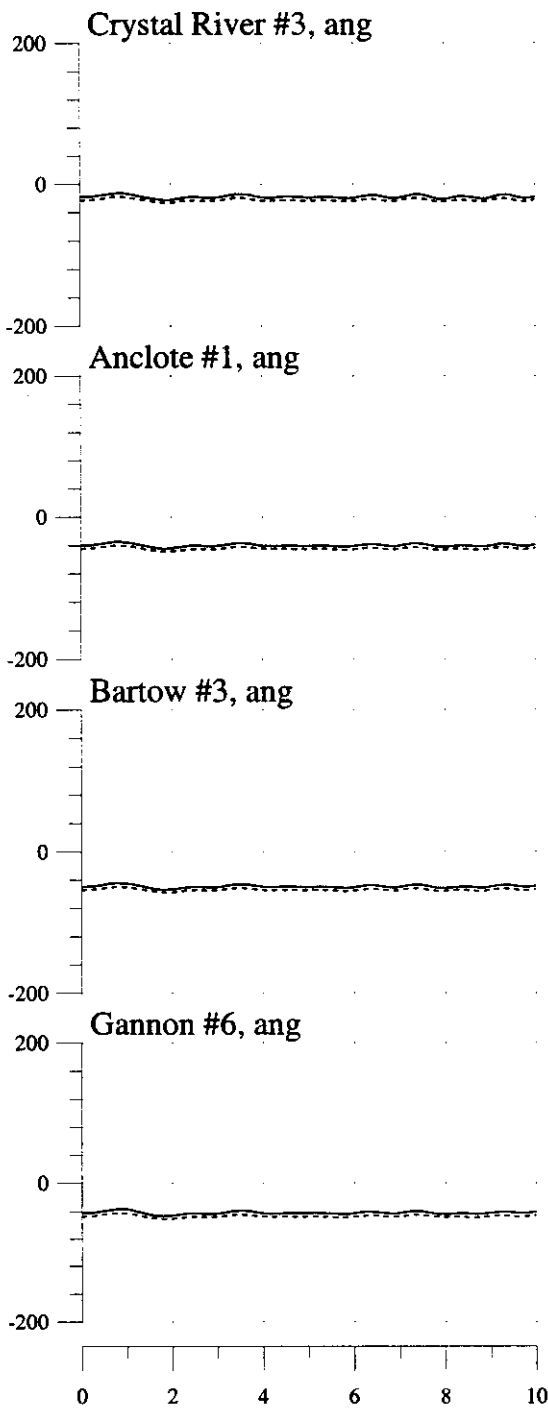

3-phase, 5-cycle Fault at Okeechobee 230kV Bus, Trip Okeechobee-Sherman 230kV Line
2003 Summer System

Machine Variables: (—) With Okeechobee JEA Dispatch, (...) Without

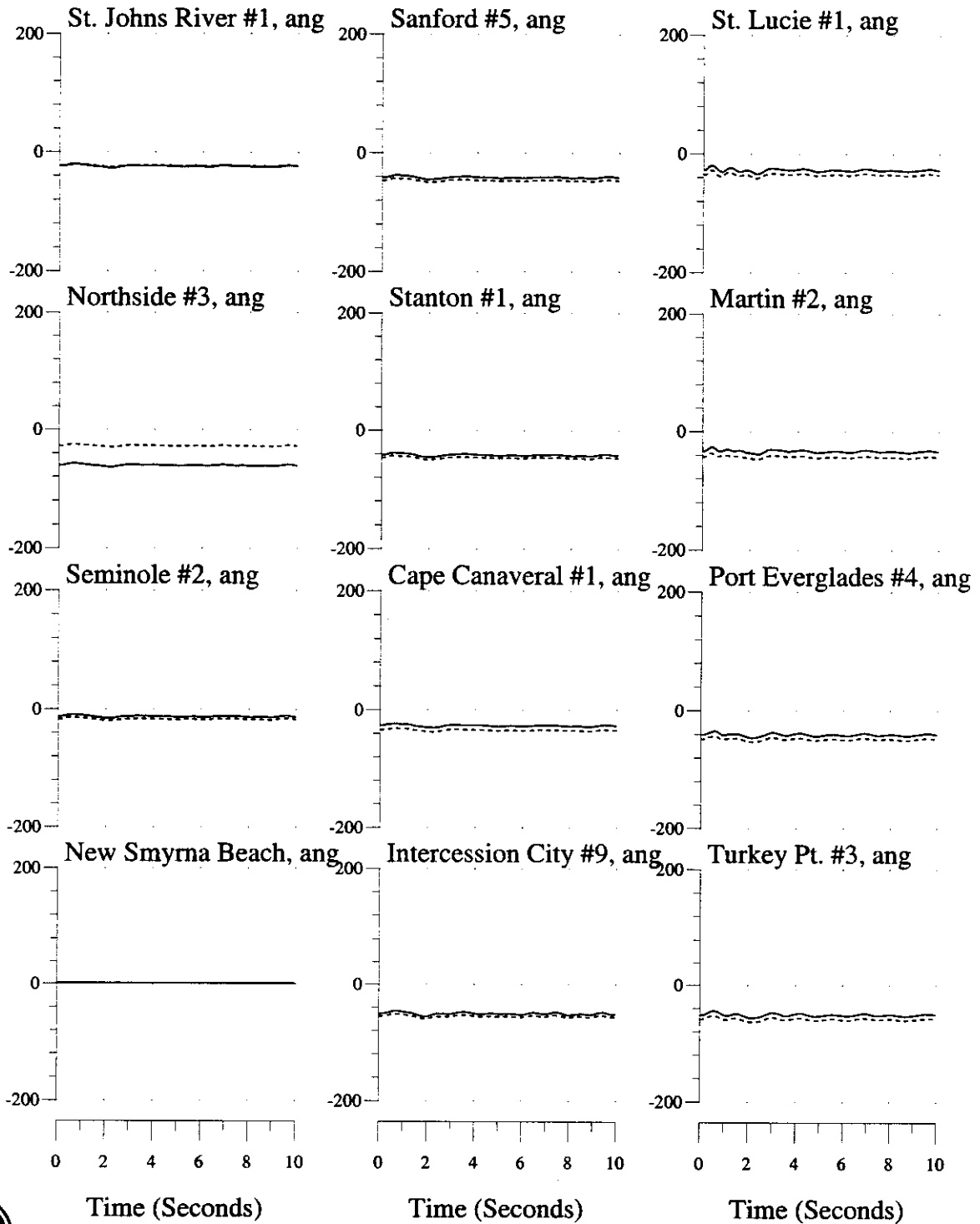

3-phase, 5-cycle Fault at Okeechobee 230kV Bus, Trip Okeechobee-Sherman 230kV Line
 2003 Summer System

Bus Variables: (___) With Okeechobee JEA Dispatch, (...) Without

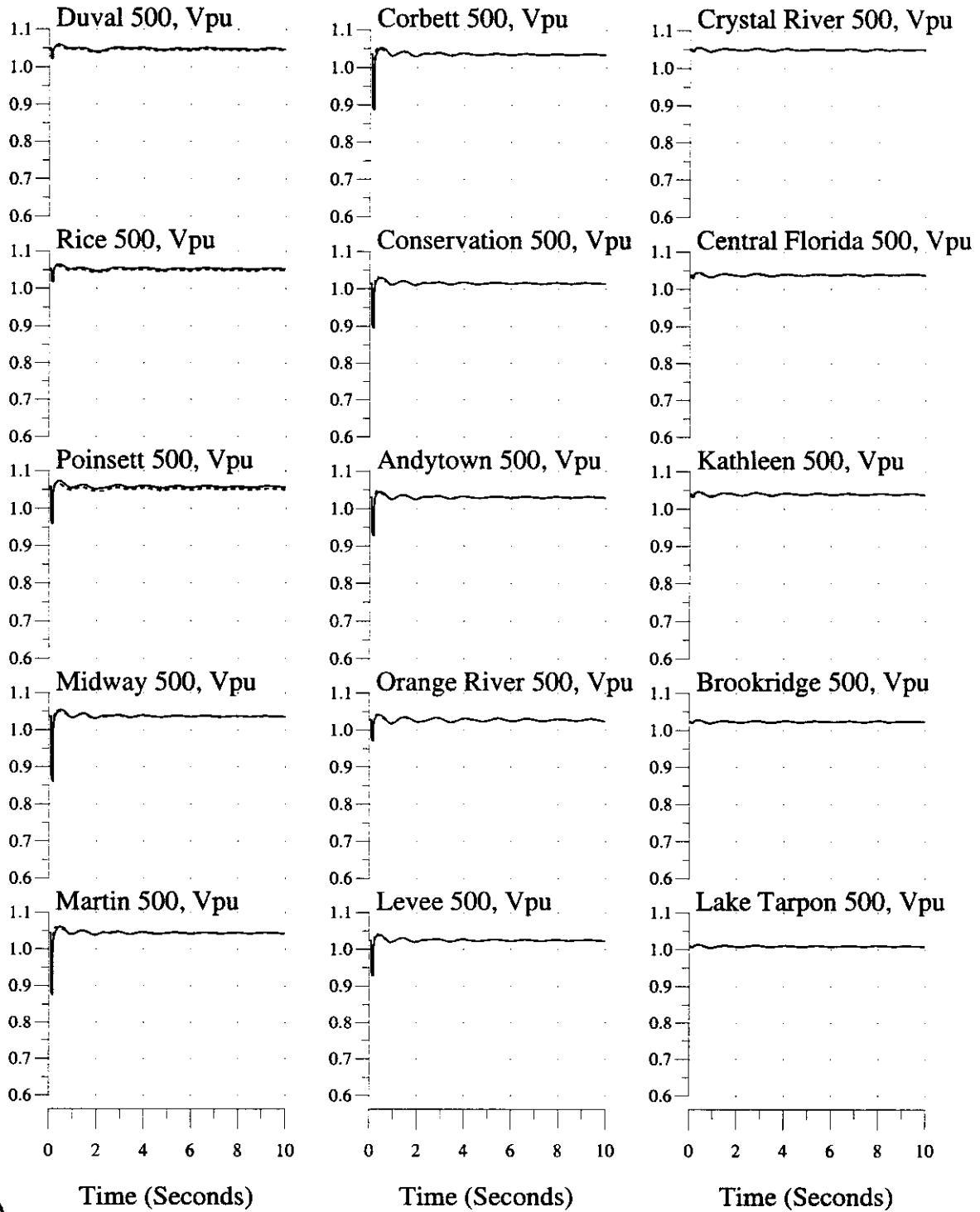

3-phase, 5-cycle Fault at Okeechobee 230kV Bus, Trip Okeechobee-Sherman 230kV Line
2003 Summer System

Bus Variables: (—) With Okeechobee JEA Dispatch, (...) Without

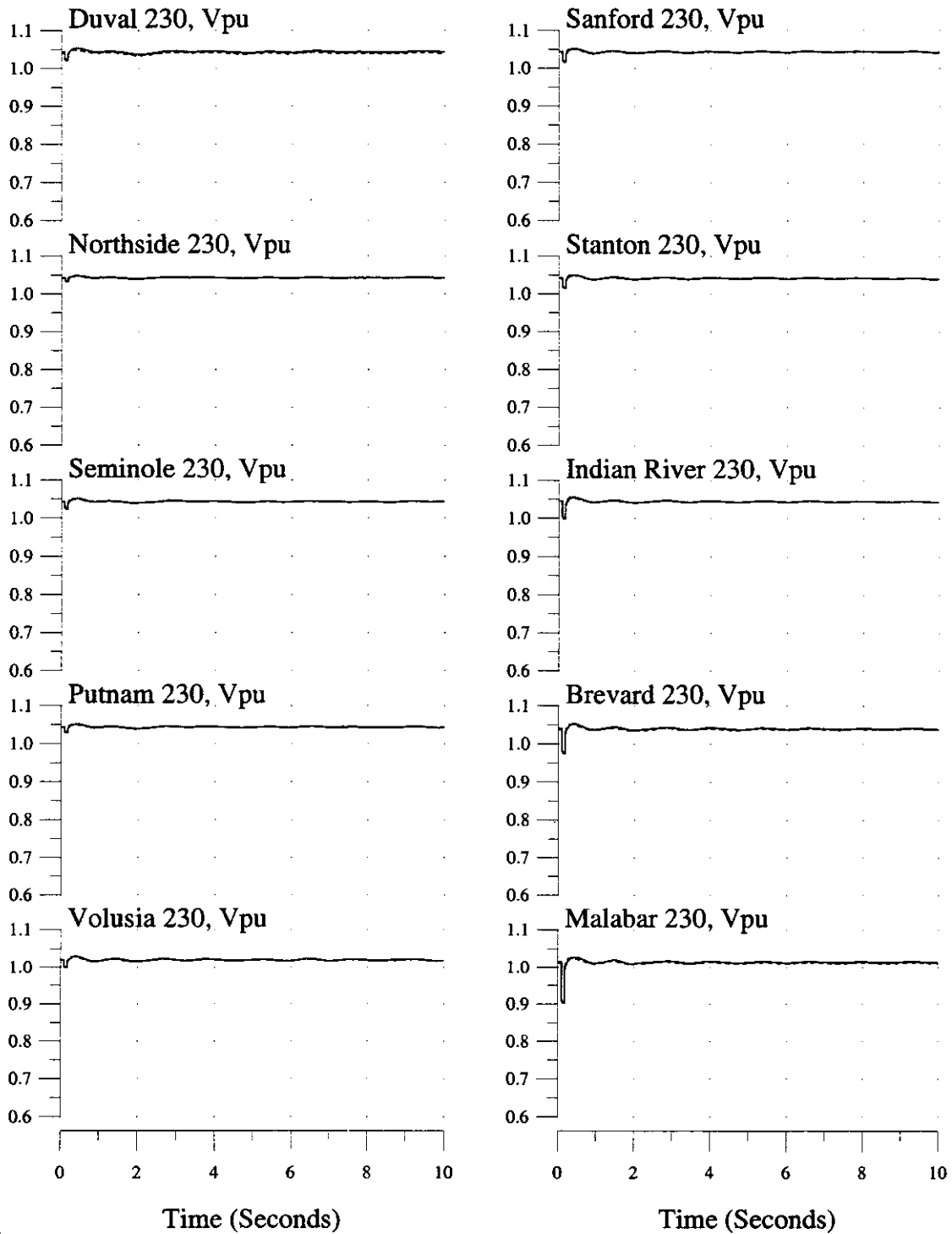

3-phase, 5-cycle Fault at Okeechobee 230kV Bus, Trip Okeechobee-Sherman 230kV Line
2003 Summer System

Bus Variables: (___) With Okeechobee JEA Dispatch, (...) Without

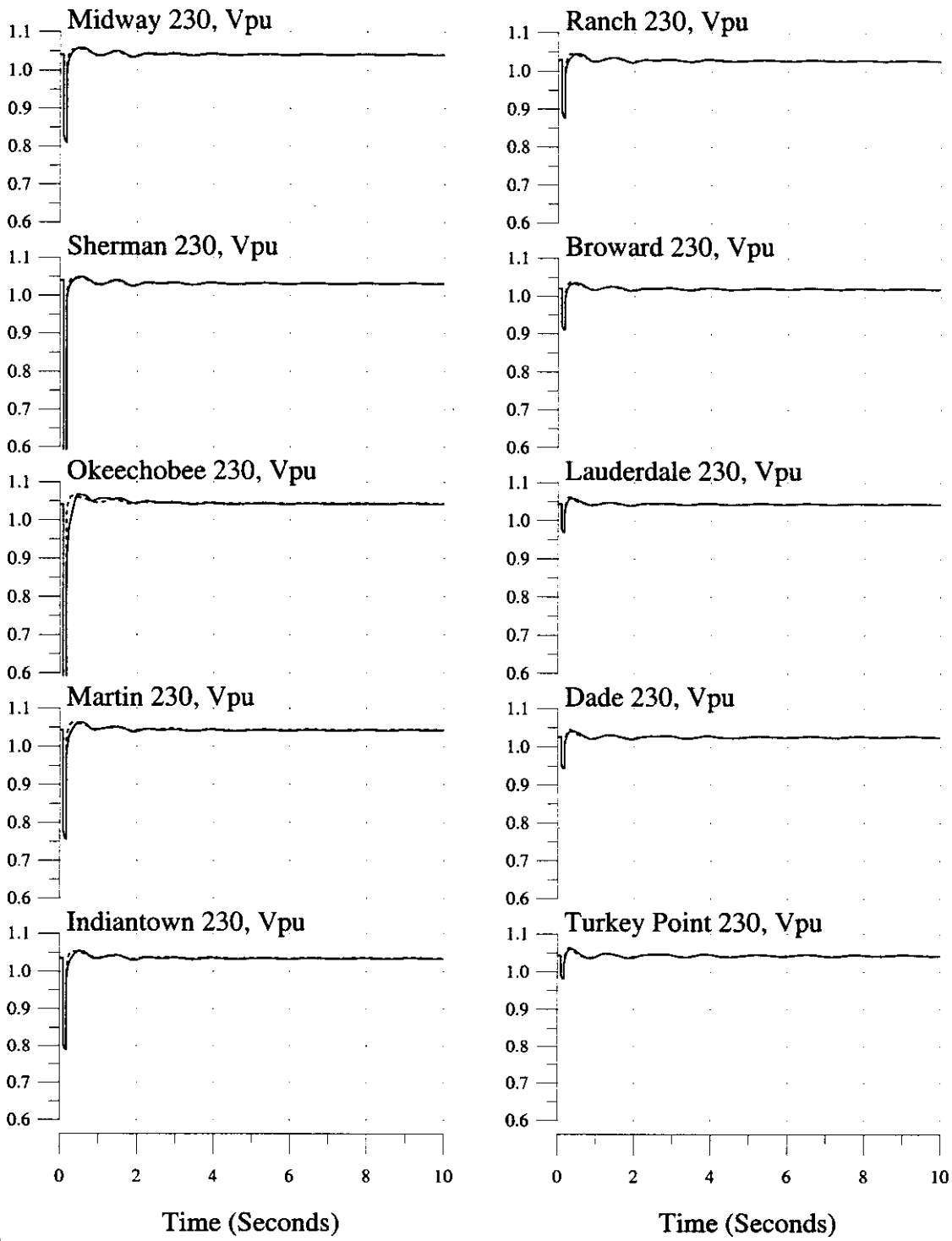

3-phase, 5-cycle Fault at Okeechobee 230kV Bus, Trip Okeechobee-Sherman 230kV Line
2003 Summer System

Bus Variables: (—) With Okeechobee JEA Dispatch, (...) Without

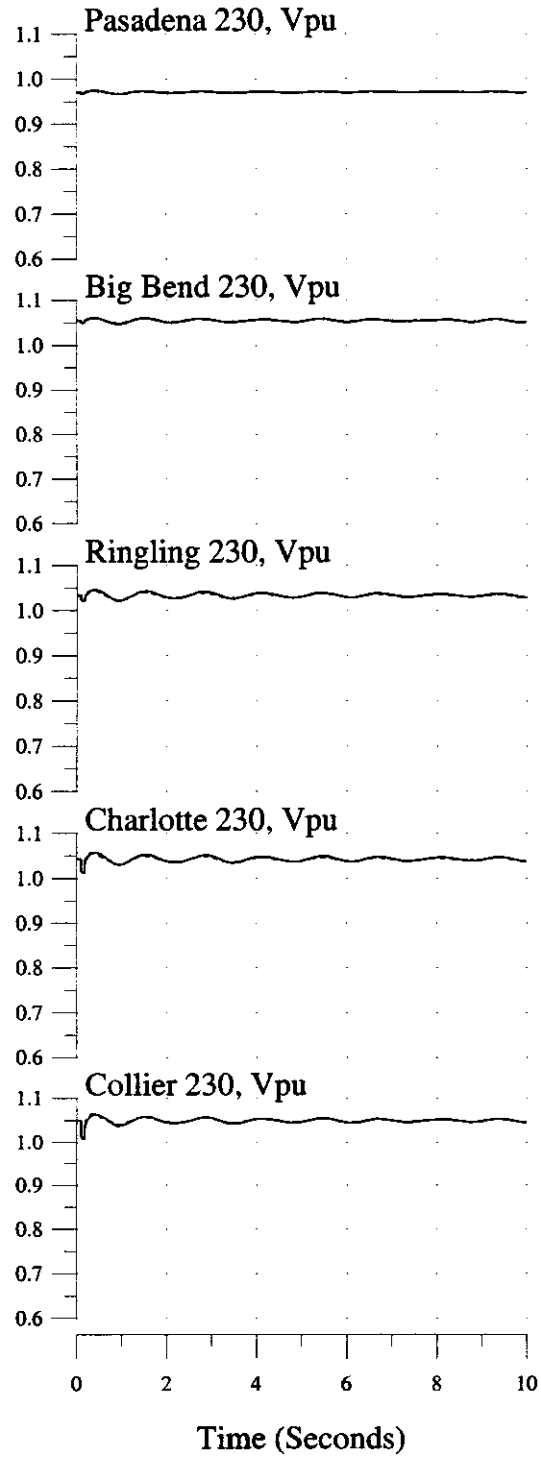
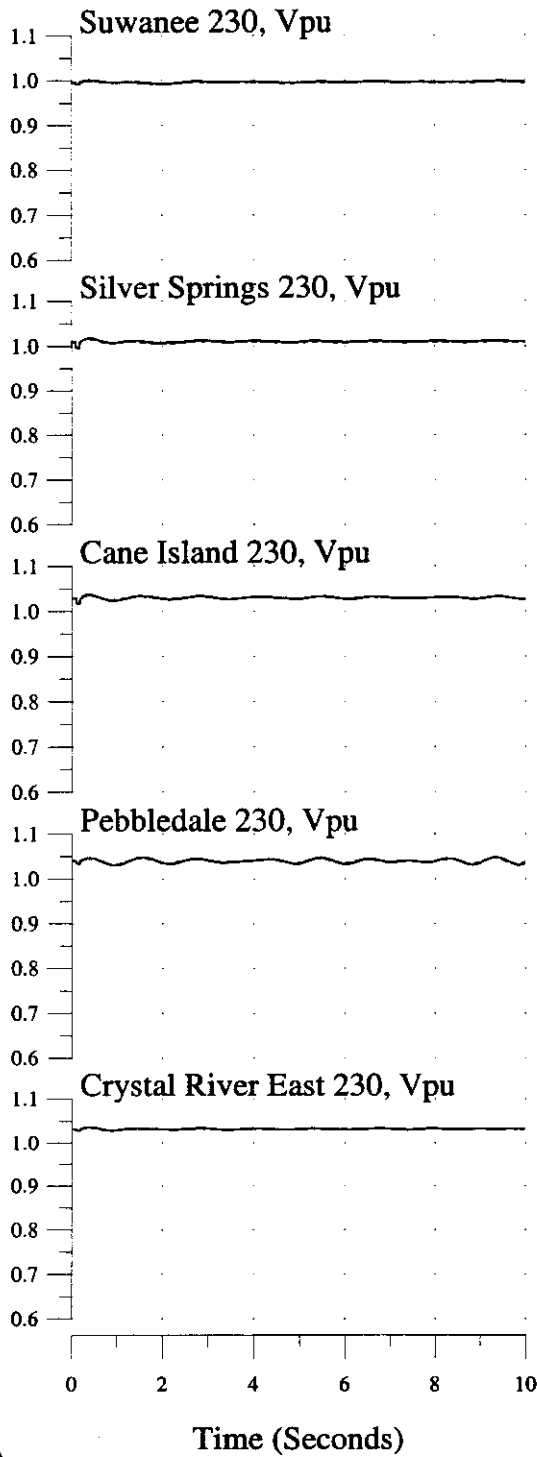

3-phase, 5-cycle Fault at Okeechobee 230kV Bus, Trip Okeechobee-Martin 230kV Line
2003 Summer System

Machine & Interface Variables: (___) With Okeechobee JEA Dispatch, (...) Without

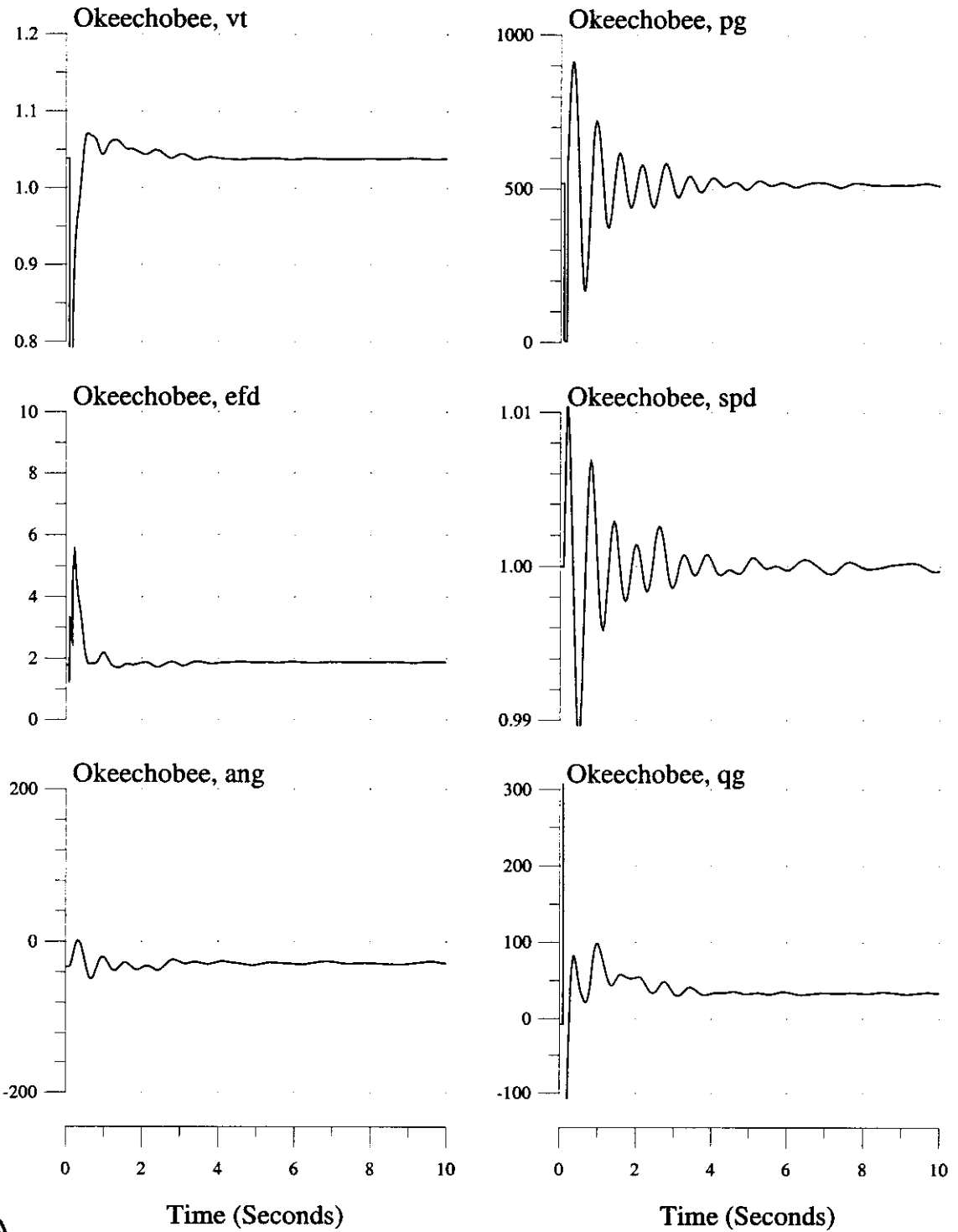

3-phase, 5-cycle Fault at Okeechobee 230kV Bus, Trip Okeechobee-Martin 230kV Line
2003 Summer System

Machine & Interface Variables: (—) With Okeechobee JEA Dispatch, (...) Without

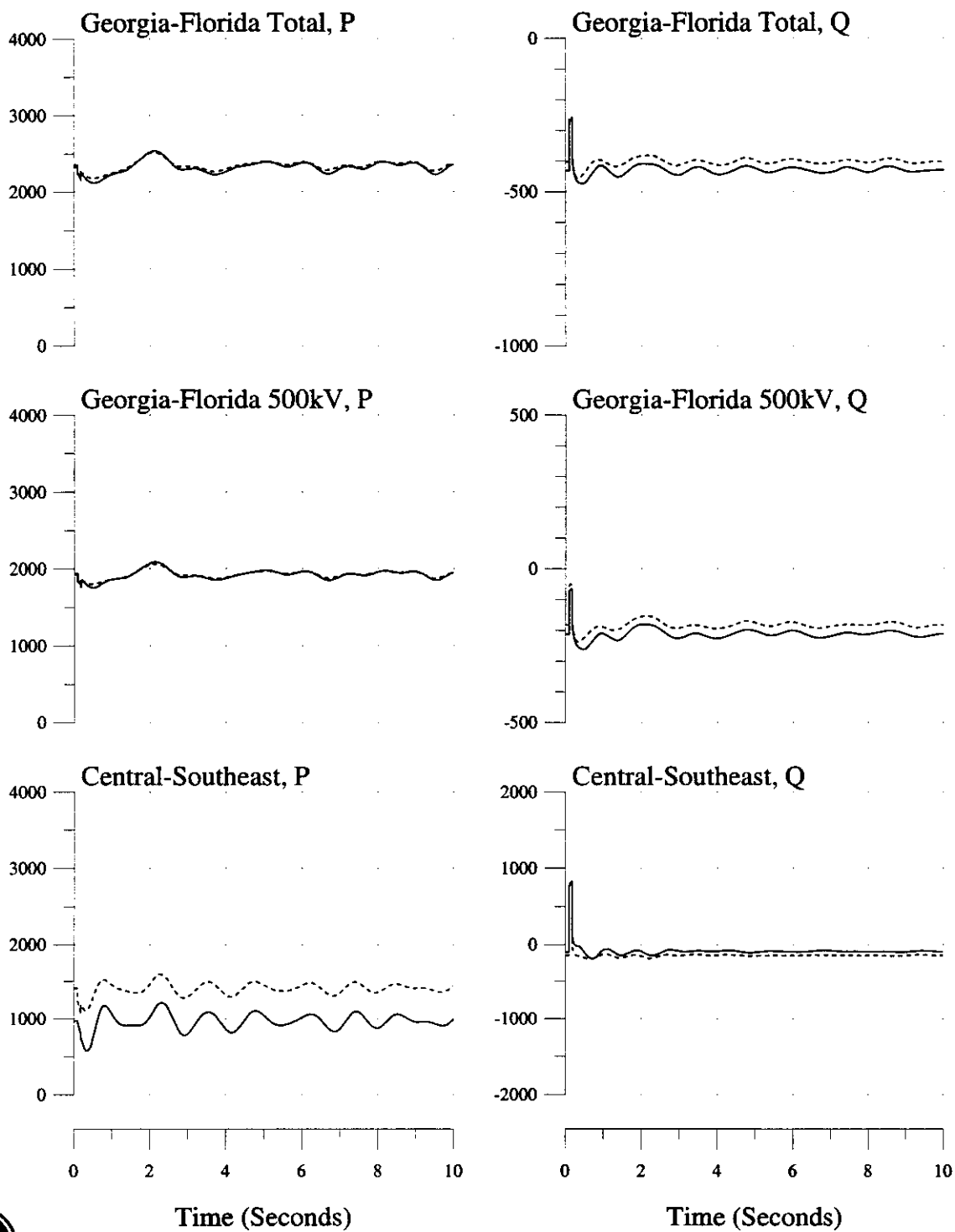

3-phase, 5-cycle Fault at Okeechobee 230kV Bus, Trip Okeechobee-Martin 230kV Line
2003 Summer System

Machine Variables: (—) With Okeechobee JEA Dispatch, (...) Without

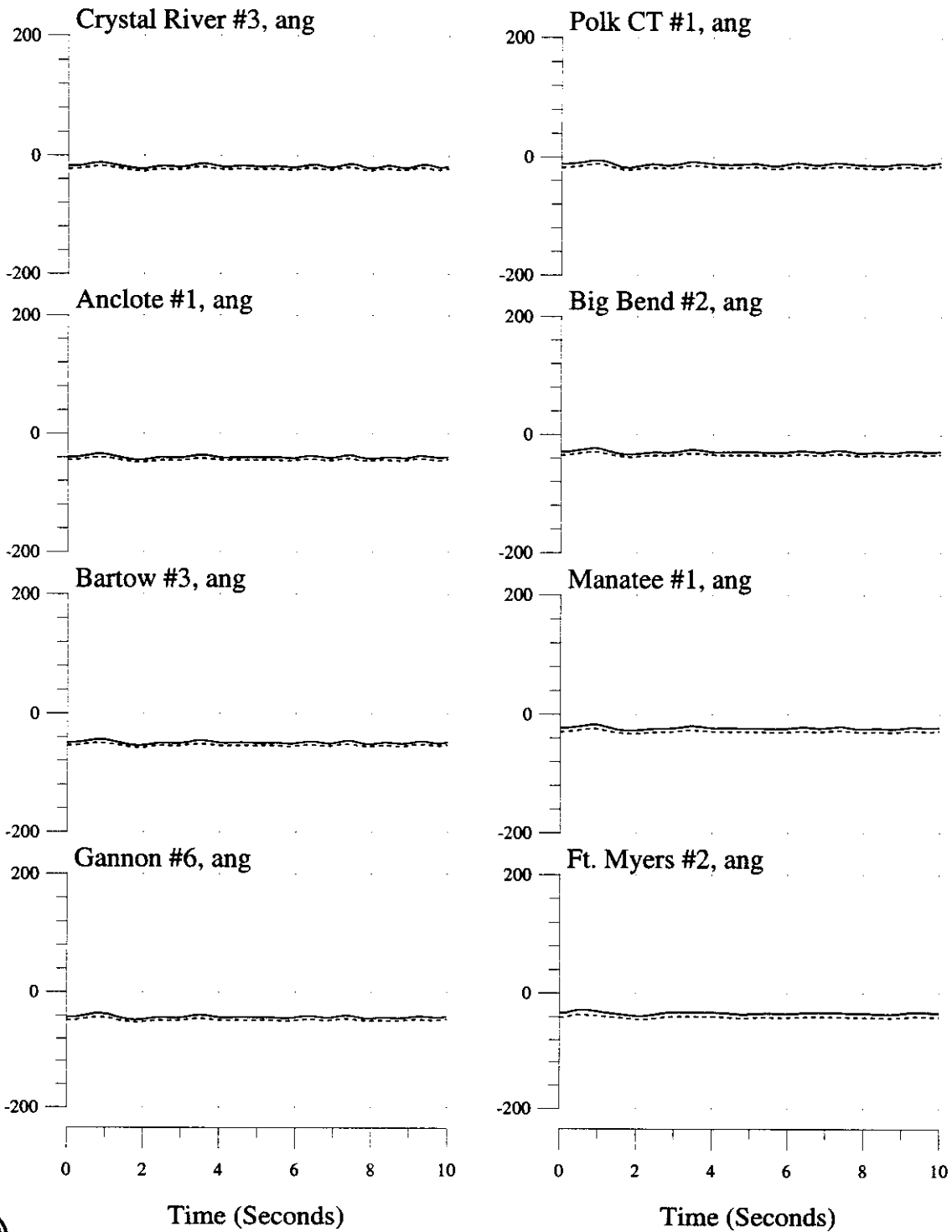

3-phase, 5-cycle Fault at Okeechobee 230kV Bus, Trip Okeechobee-Martin 230kV Line
 2003 Summer System

Machine Variables: (—) With Okeechobee JEA Dispatch, (...) Without

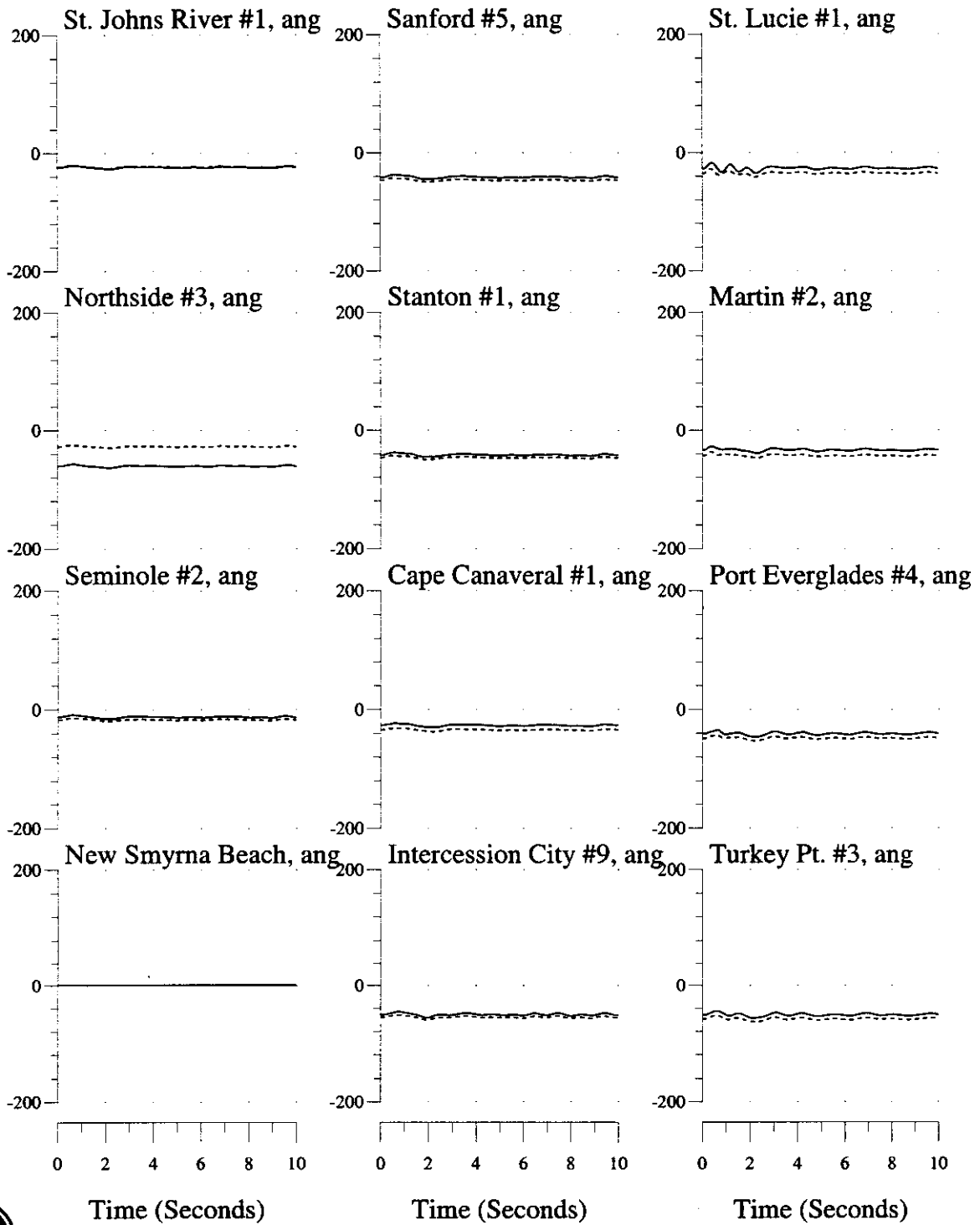

3-phase, 5-cycle Fault at Okeechobee 230kV Bus, Trip Okeechobee-Martin 230kV Line
 2003 Summer System

Bus Variables: (—) With Okeechobee JEA Dispatch, (...) Without

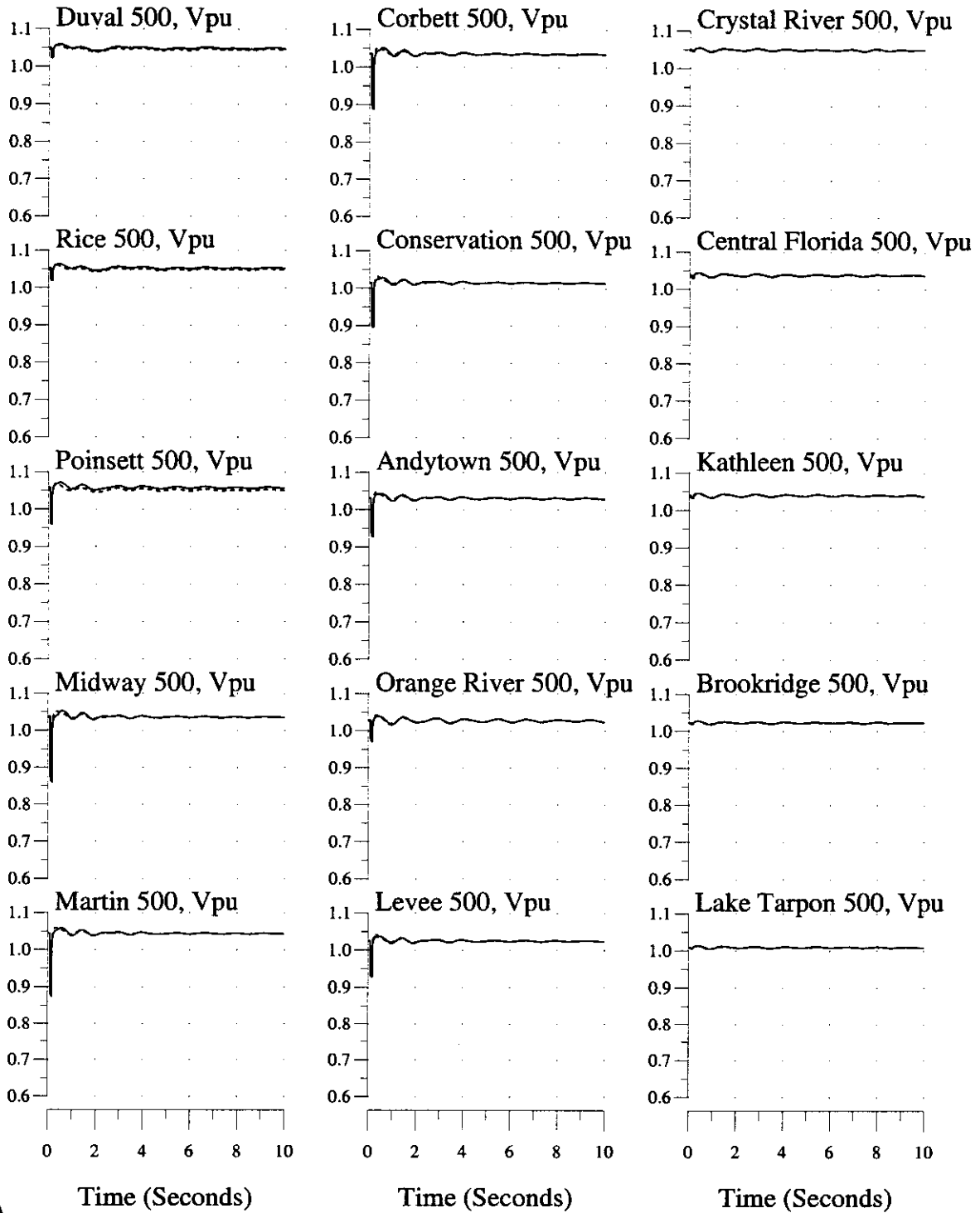

3-phase, 5-cycle Fault at Okeechobee 230kV Bus, Trip Okeechobee-Martin 230kV Line
2003 Summer System

Bus Variables: (___) With Okeechobee JEA Dispatch, (...) Without

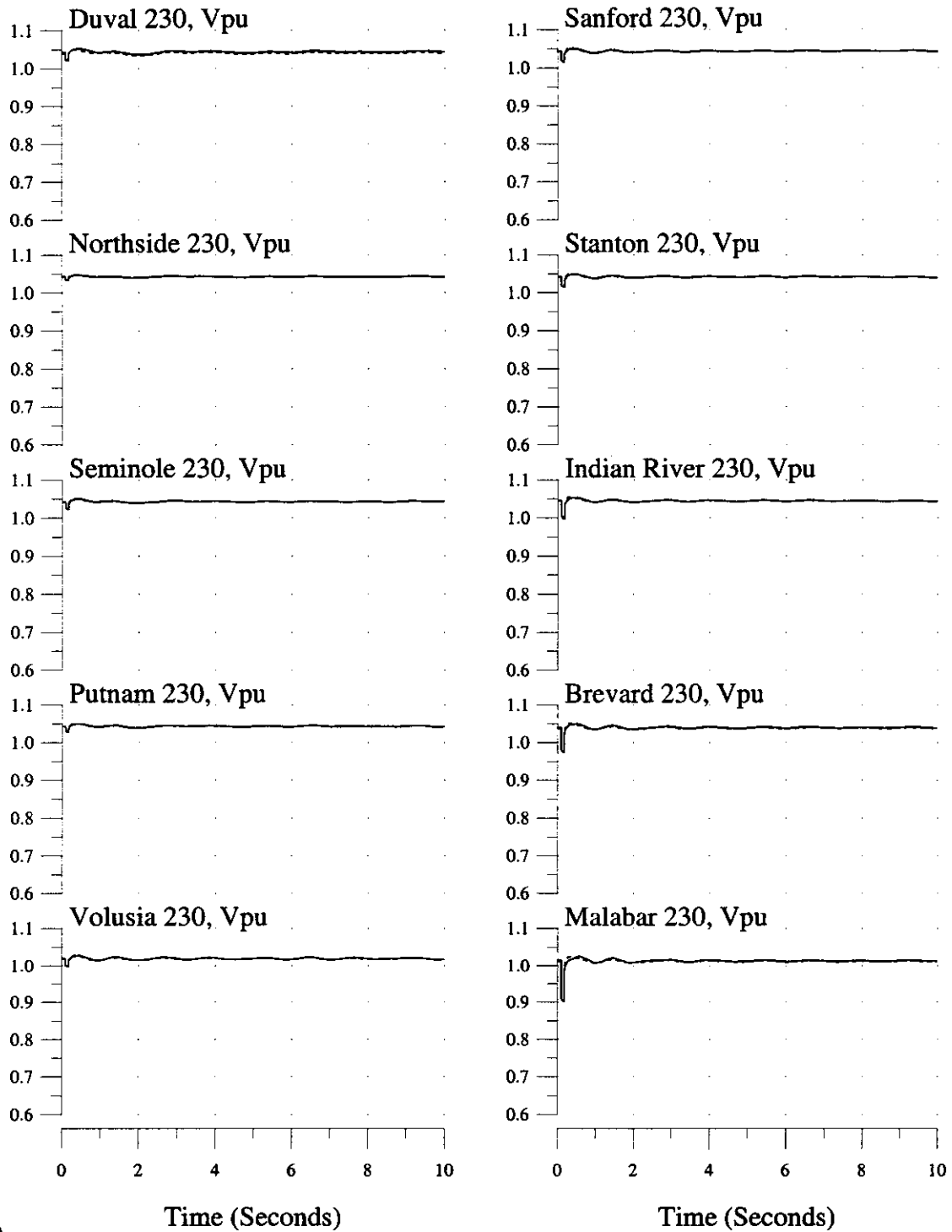

3-phase, 5-cycle Fault at Okeechobee 230kV Bus, Trip Okeechobee-Martin 230kV Line
 2003 Summer System

Bus Variables: (___) With Okeechobee JEA Dispatch, (...) Without

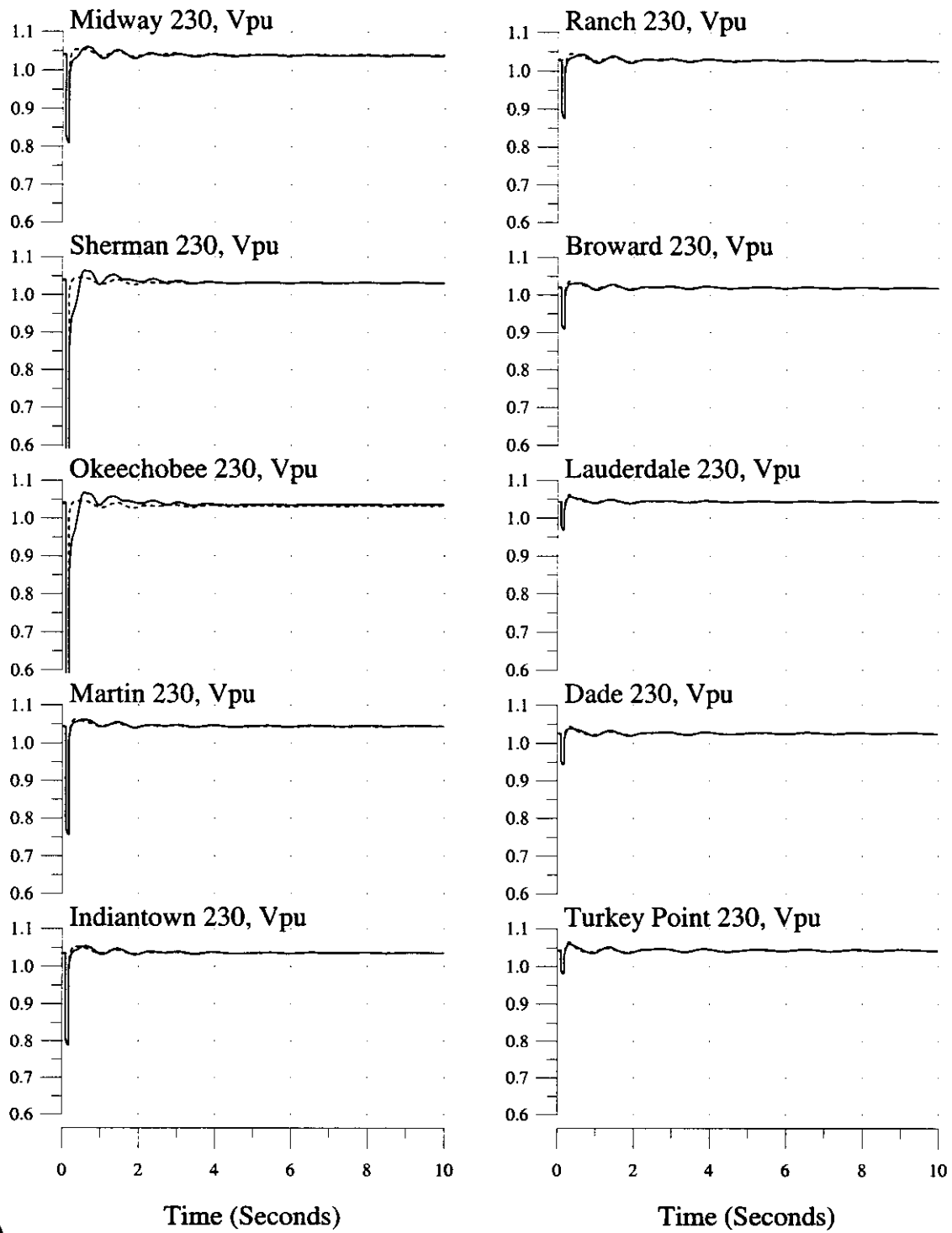

3-phase, 5-cycle Fault at Okeechobee 230kV Bus, Trip Okeechobee-Martin 230kV Line
2003 Summer System

Bus Variables: (___) With Okeechobee JEA Dispatch, (...) Without

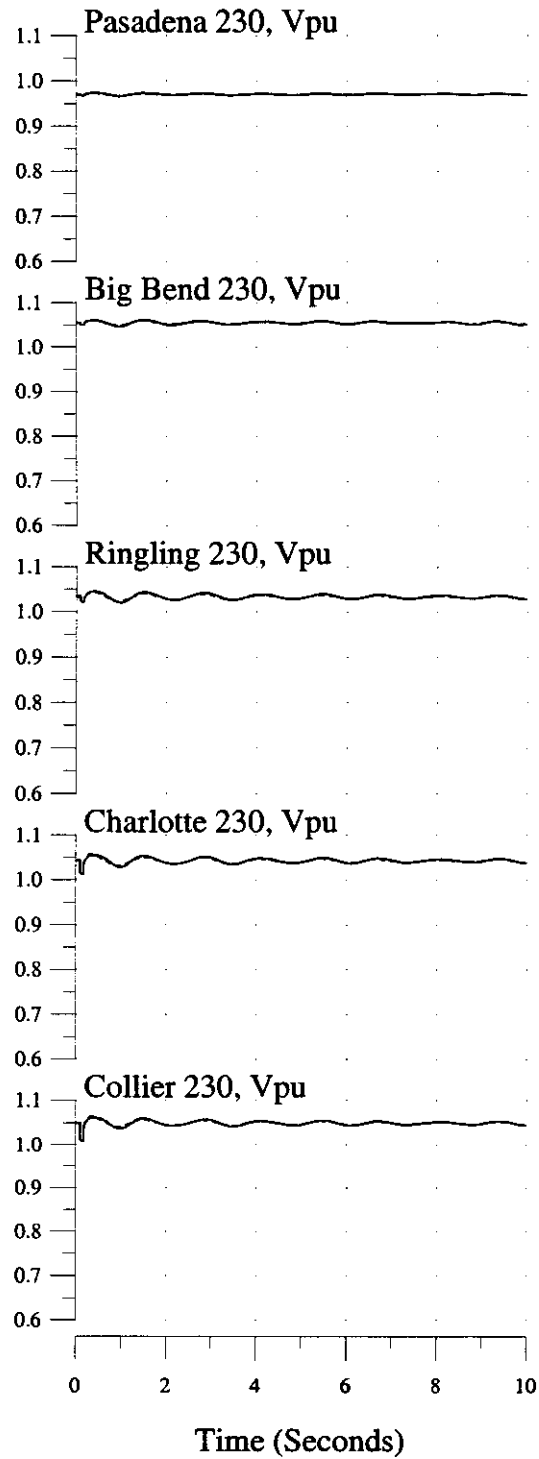
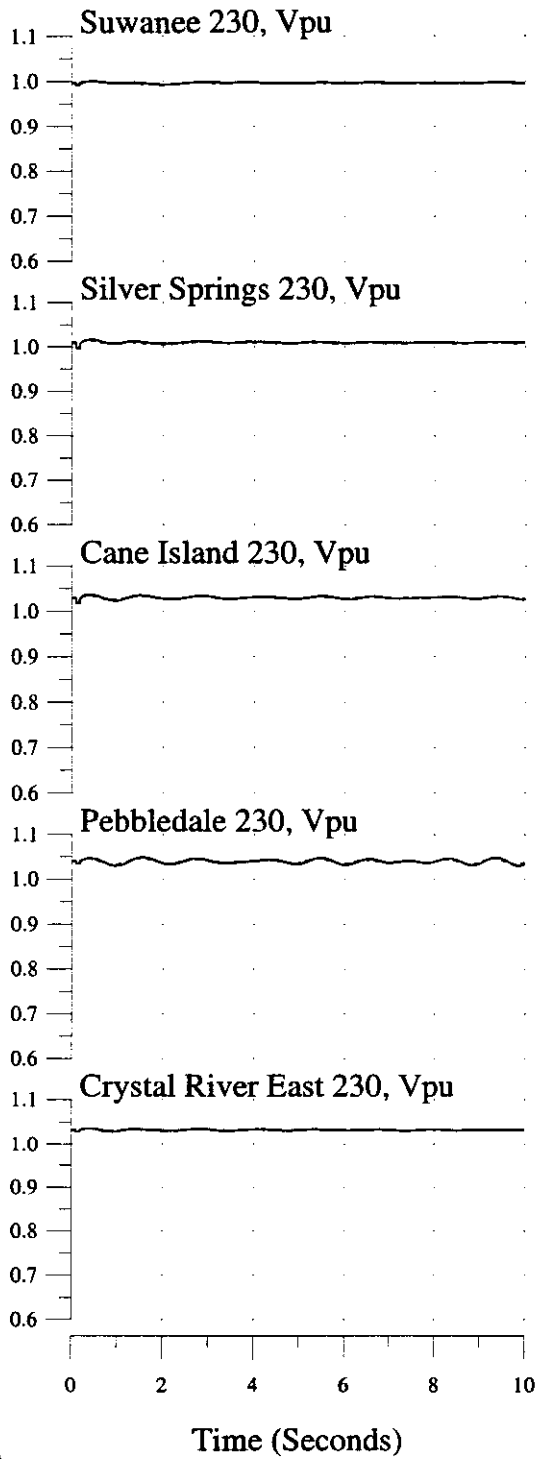

3-ph, 5-cy Fault at Martin 500kV Bus, Trip Martin #2 & GSU, TT Martin-Poinsett 500kV Line
2003 Summer System

Machine & Interface Variables: (—) With Okeechobee JEA Dispatch, (...) Without

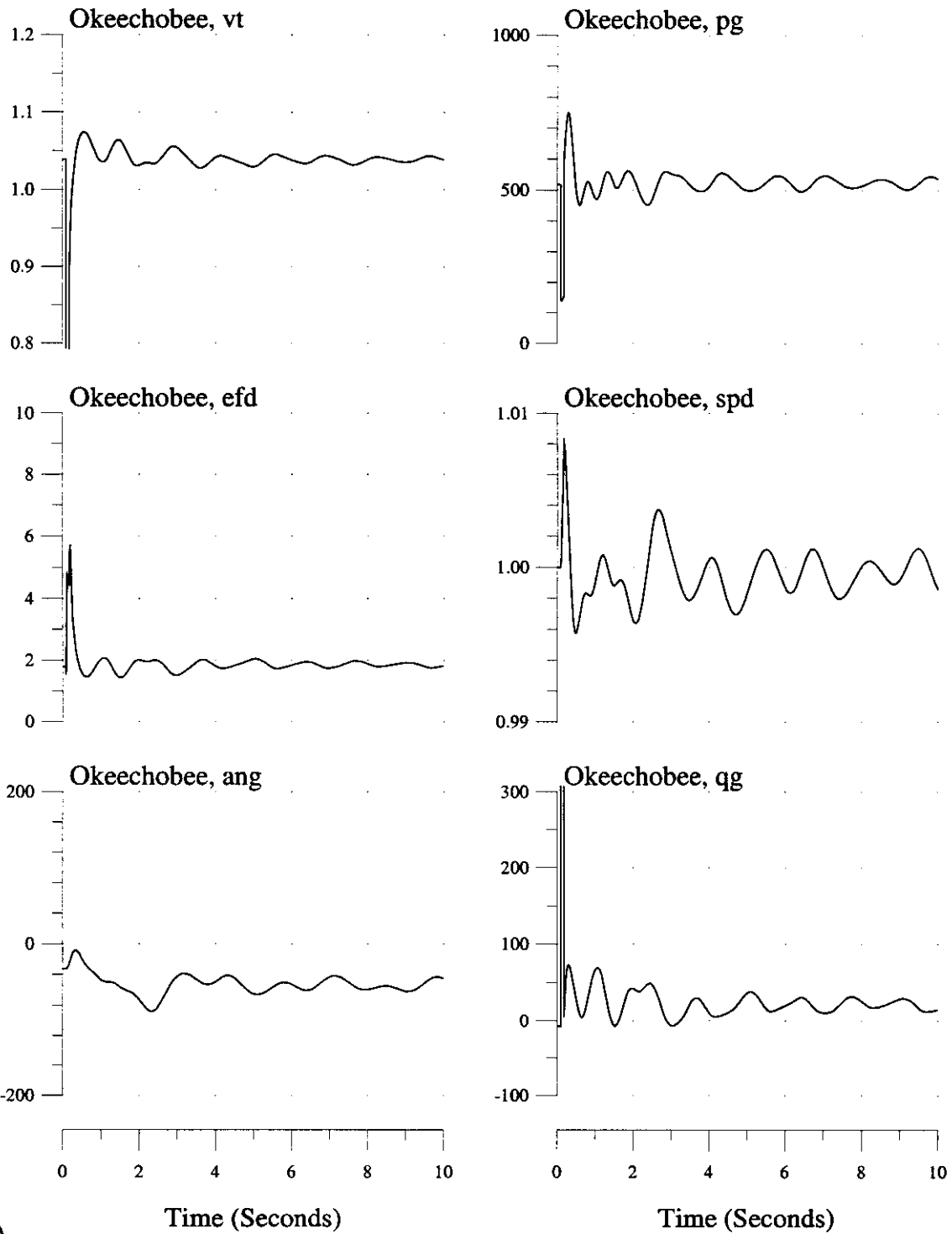

3-ph, 5-cy Fault at Martin 500kV Bus, Trip Martin #2 & GSU, TT Martin-Poinsett 500kV Line
2003 Summer System

Machine & Interface Variables: (—) With Okeechobee JEA Dispatch, (...) Without

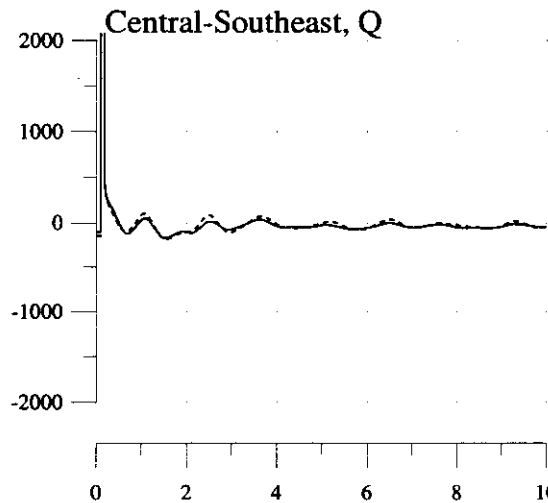
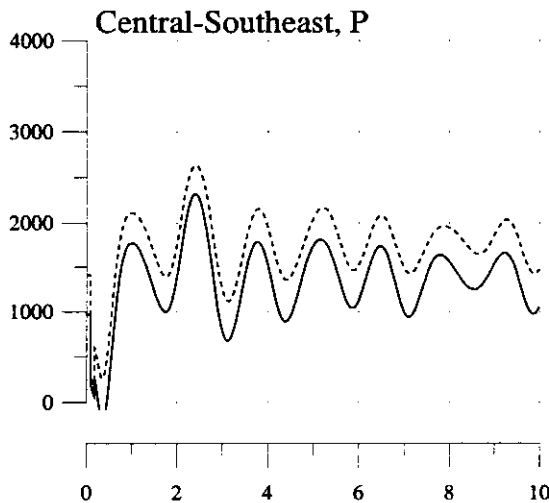
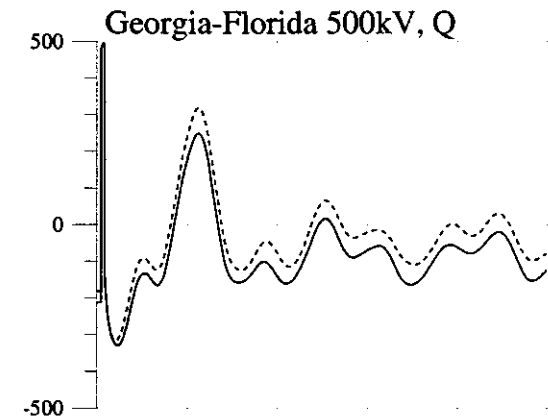
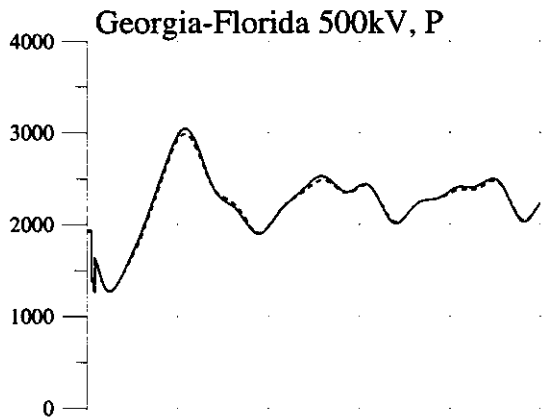
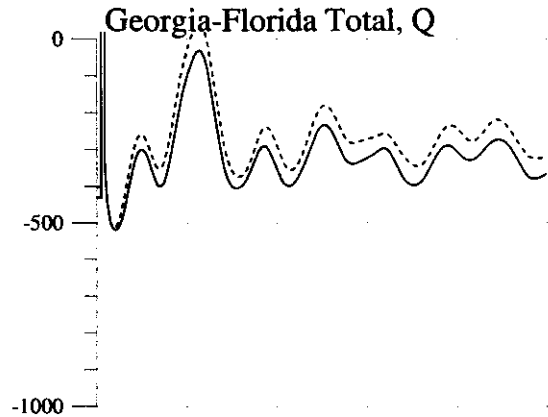
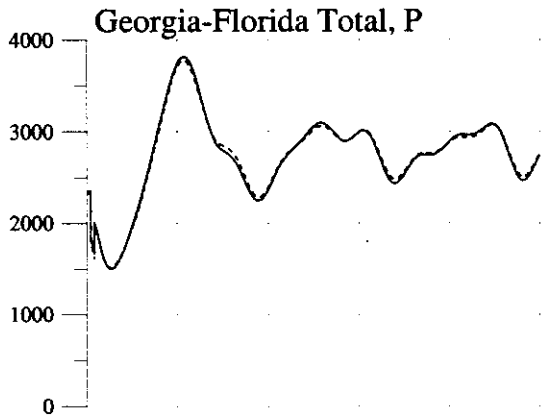

Time (Seconds)

Time (Seconds)



3-ph, 5-cy Fault at Martin 500kV Bus, Trip Martin #2 & GSU, TT Martin-Poinsett 500kV Line
2003 Summer System

Machine Variables: (—) With Okeechobee JEA Dispatch, (...) Without

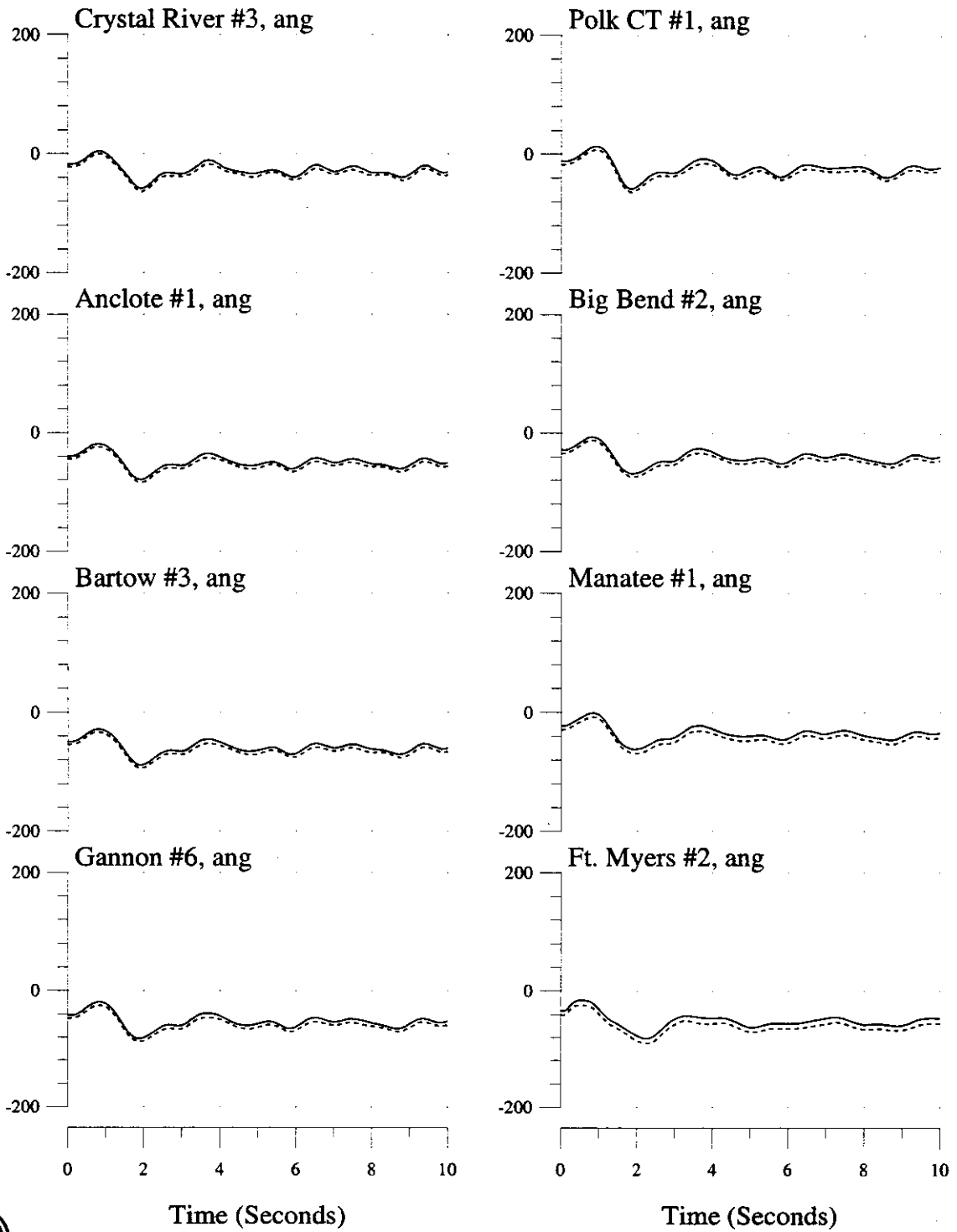

3-ph, 5-cy Fault at Martin 500kV Bus, Trip Martin #2 & GSU, TT Martin-Poinsett 500kV Line
 2003 Summer System

Machine Variables: (—) With Okeechobee JEA Dispatch, (...) Without

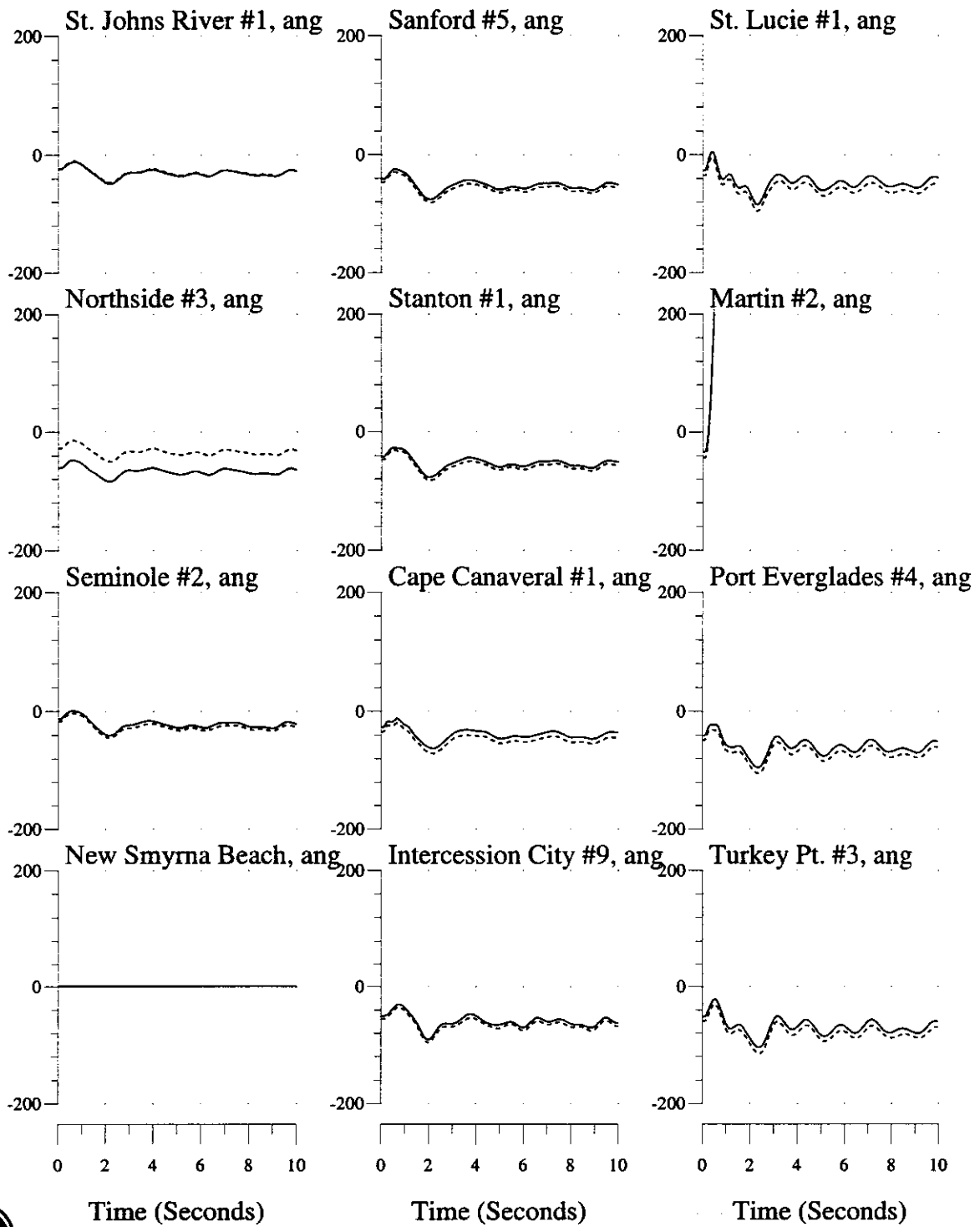

3-ph, 5-cy Fault at Martin 500kV Bus, Trip Martin #2 & GSU, TT Martin-Poinsett 500kV Line
 2003 Summer System

Bus Variables: (—) With Okeechobee JEA Dispatch, (...) Without

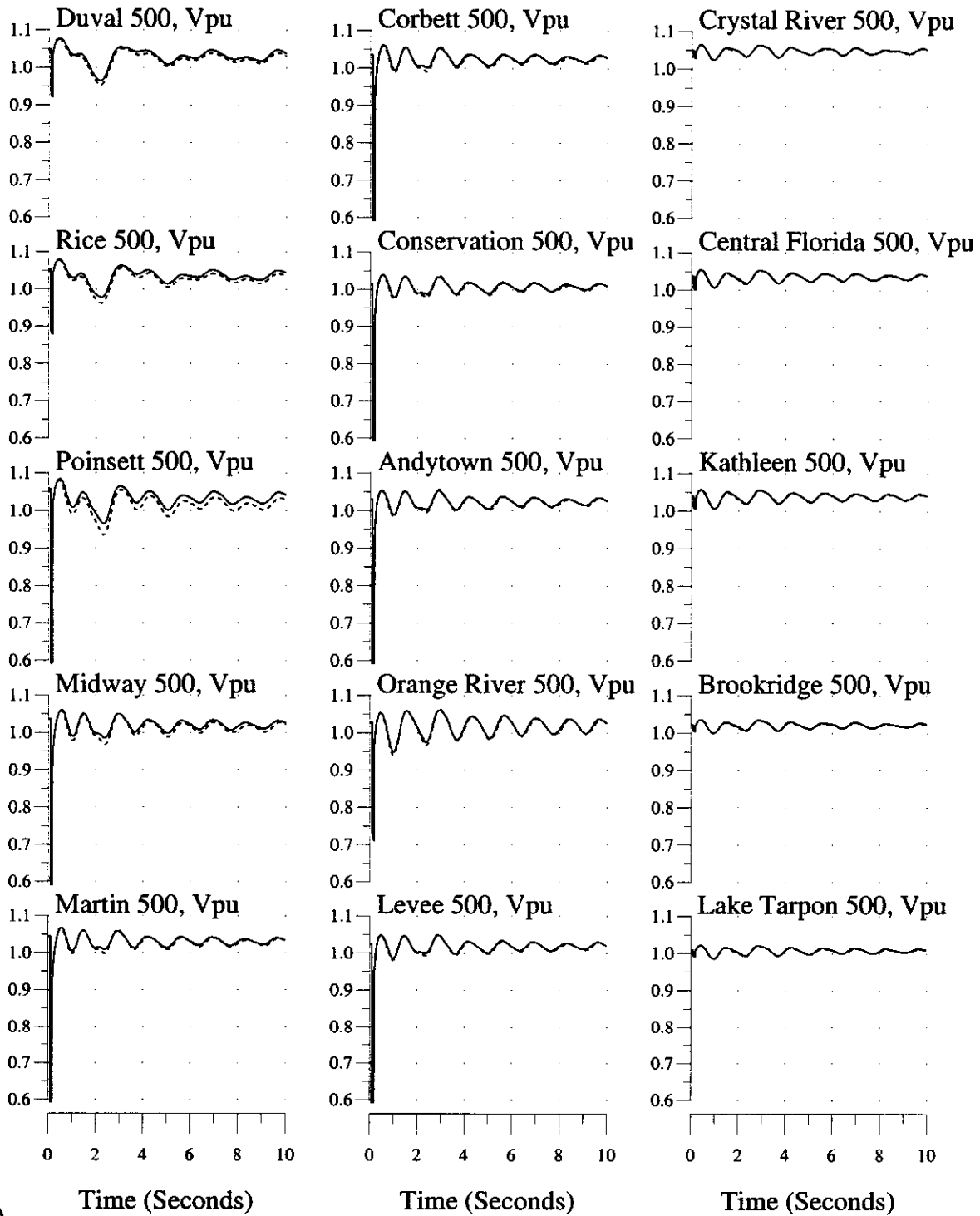

3-ph, 5-cy Fault at Martin 500kV Bus, Trip Martin #2 & GSU, TT Martin-Poinsett 500kV Line
2003 Summer System

Bus Variables: (—) With Okeechobee JEA Dispatch, (...) Without

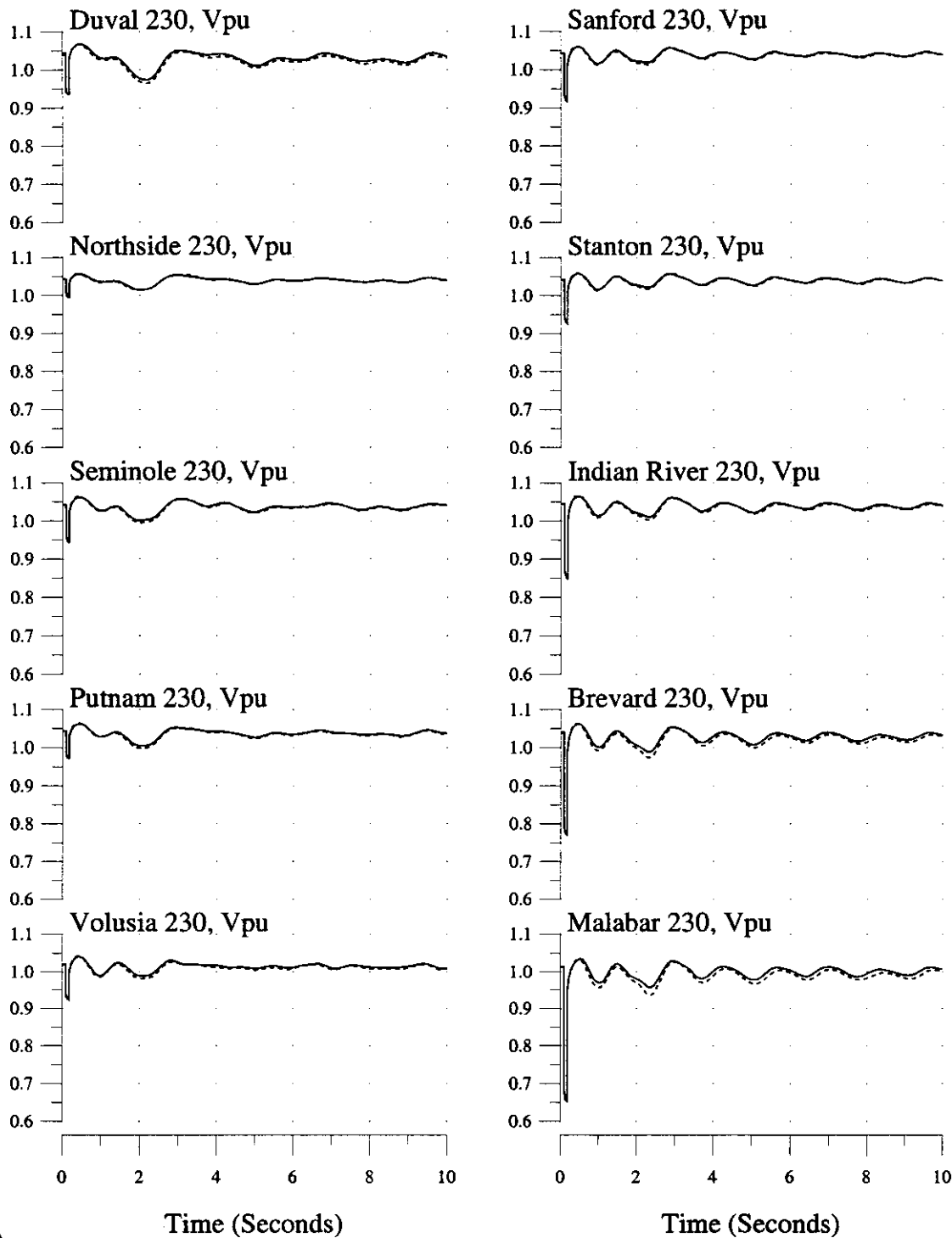

3-ph, 5-cy Fault at Martin 500kV Bus, Trip Martin #2 & GSU, TT Martin-Poinsett 500kV Line
2003 Summer System

Bus Variables: (—) With Okeechobee JEA Dispatch, (...) Without

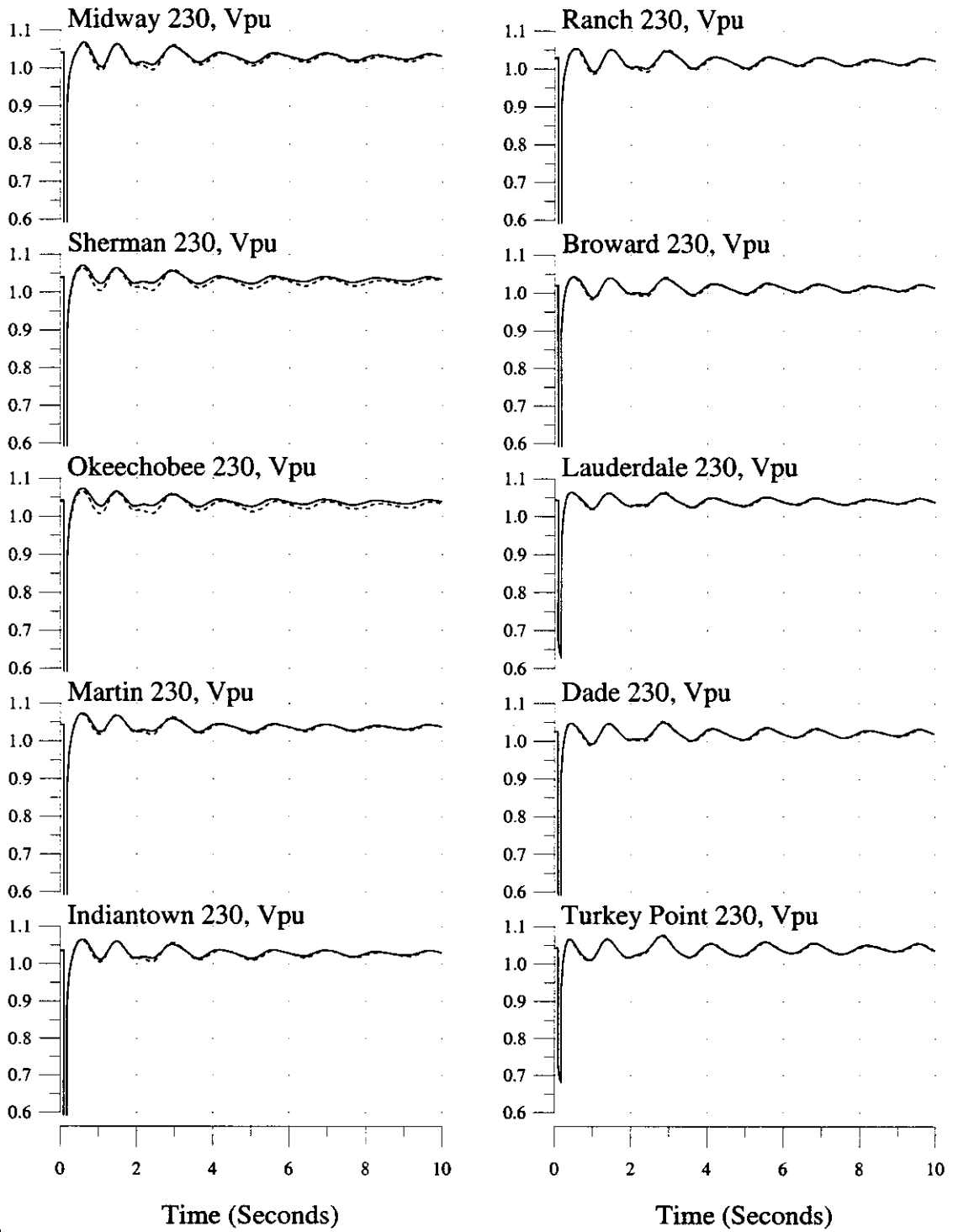

3-ph, 5-cy Fault at Martin 500kV Bus, Trip Martin #2 & GSU, TT Martin-Poinsett 500kV Line
 2003 Summer System

Bus Variables: (—) With Okeechobee JEA Dispatch, (...) Without

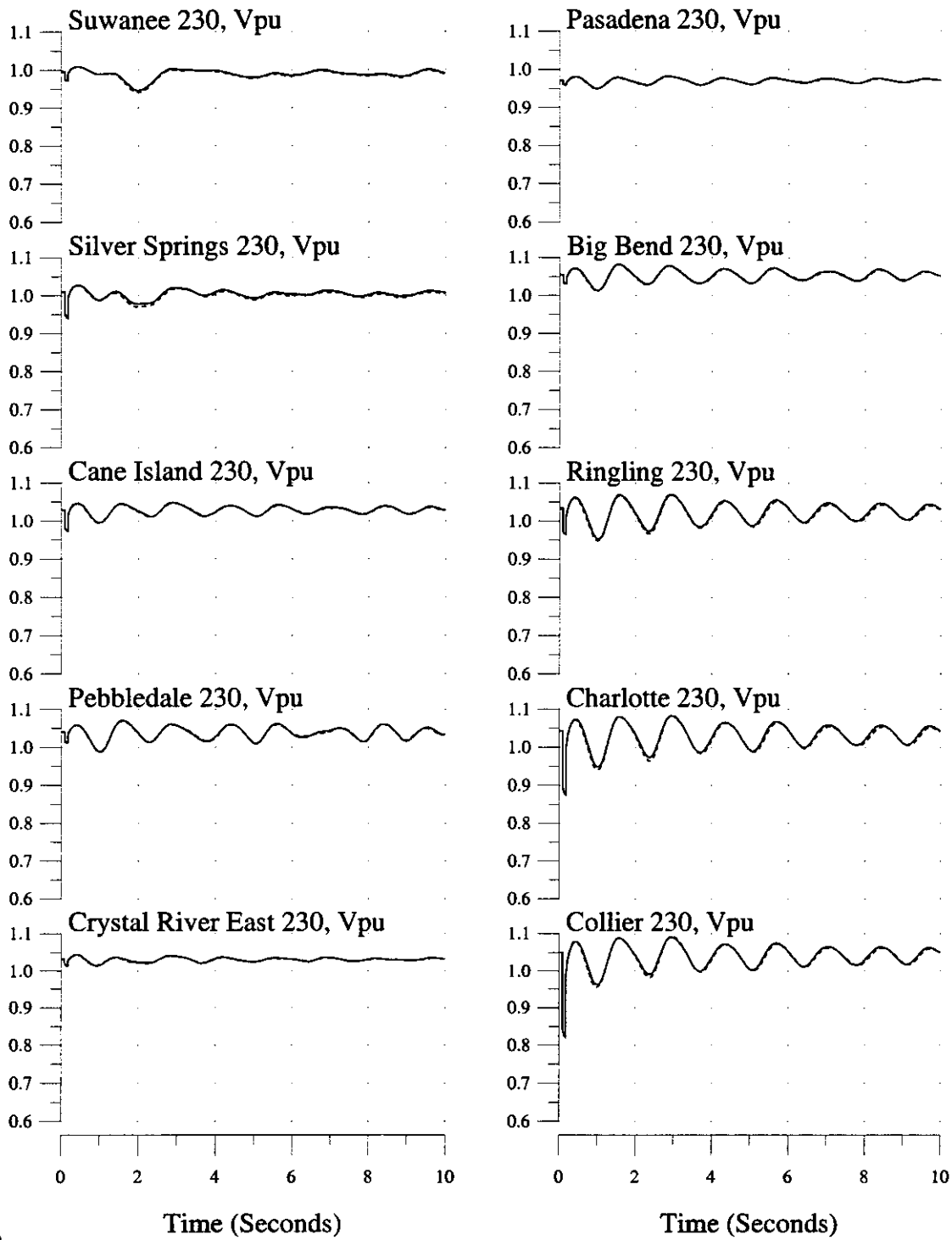

3-ph Fault at Turkey Pt 230kV Bus, Trip TP #3 & GSU @5-cy, Trip TP-Galloway 230kV Line @12cy
2003 Summer System

Machine & Interface Variables: (—) With Okeechobee JEA Dispatch, (...) Without

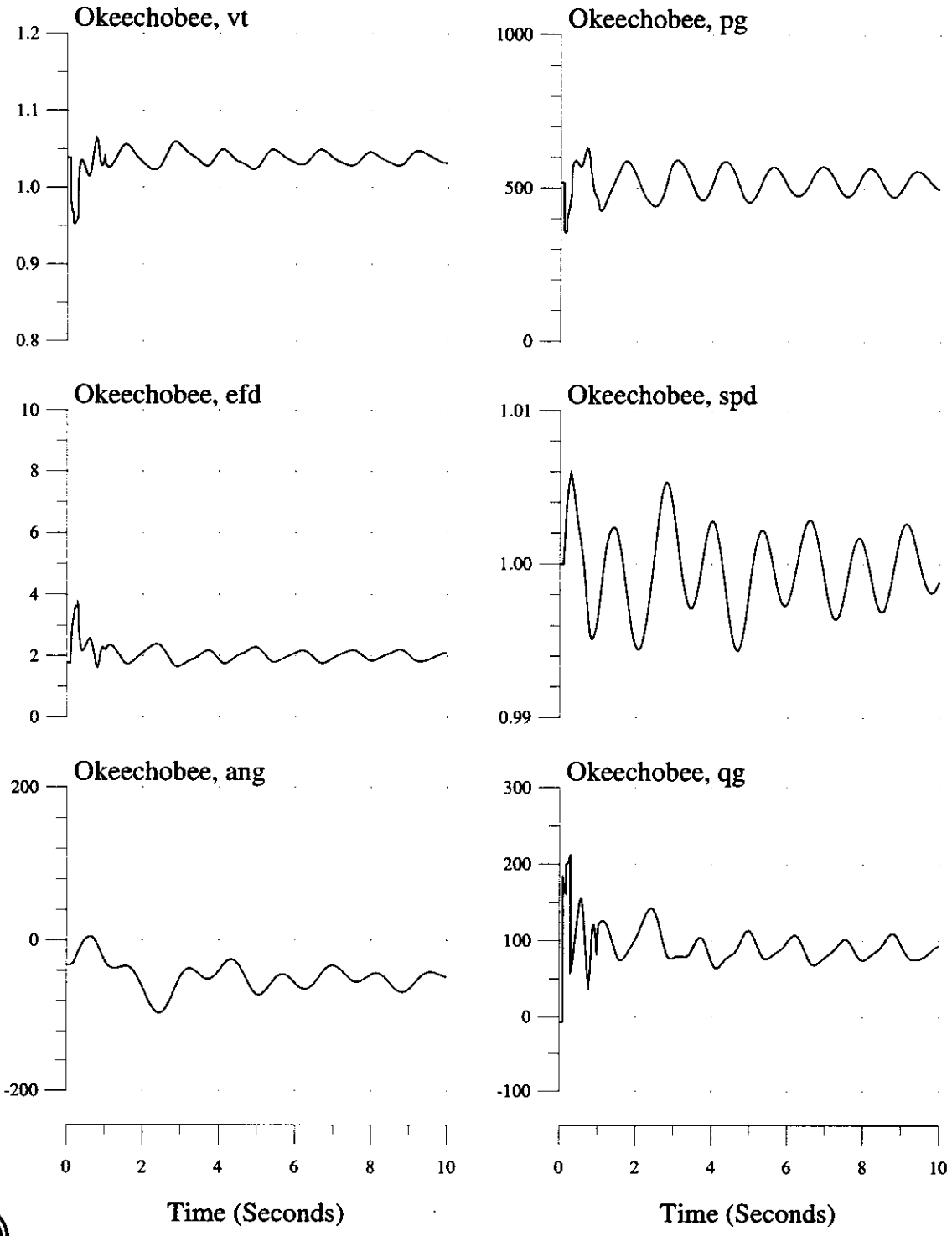

3-ph Fault at Turkey Pt 230kV Bus, Trip TP #3 & GSU @5-cy, Trip TP-Galloway 230kV Line @12cy
2003 Summer System

Machine & Interface Variables: (—) With Okeechobee JEA Dispatch, (...) Without

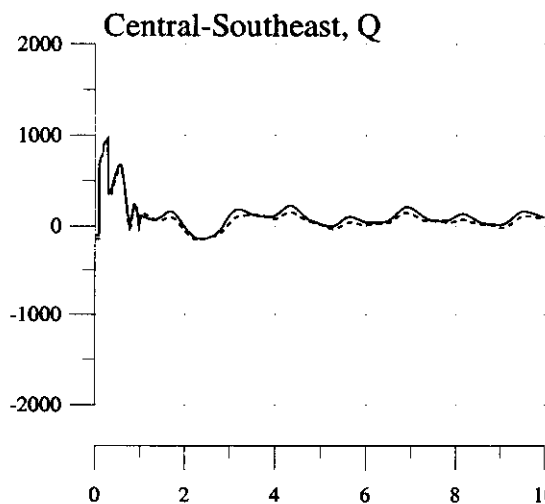
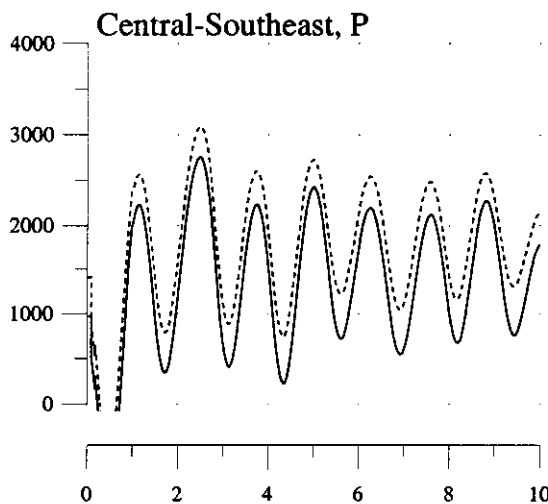
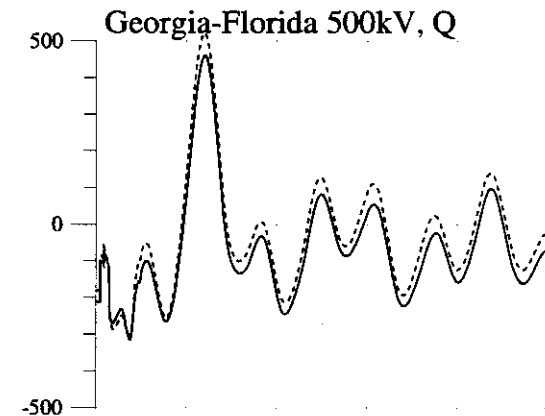
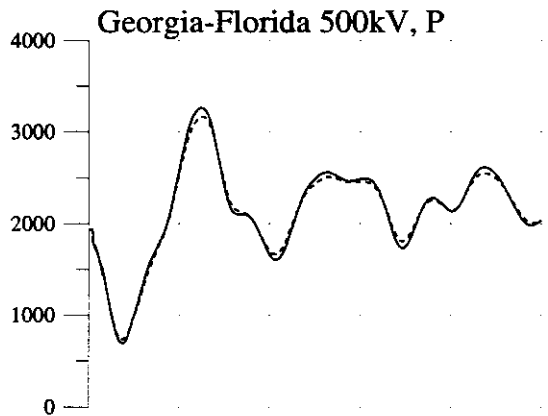
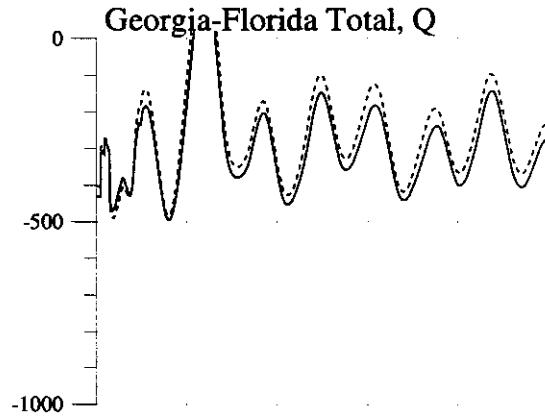
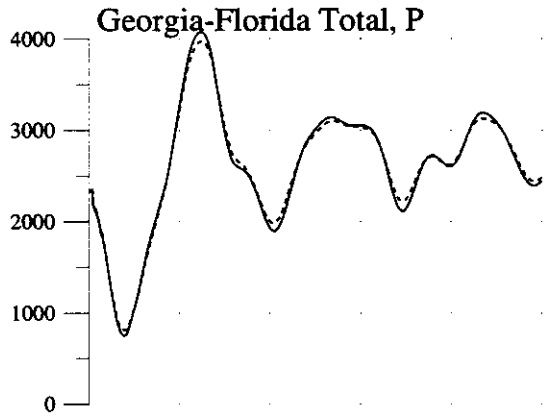

Time (Seconds)

Time (Seconds)



3-ph Fault at Turkey Pt 230kV Bus, Trip TP #3 & GSU @5-cy, Trip TP-Galloway 230kV Line @12cy
2003 Summer System

Machine Variables: (—) With Okeechobee JEA Dispatch, (...) Without

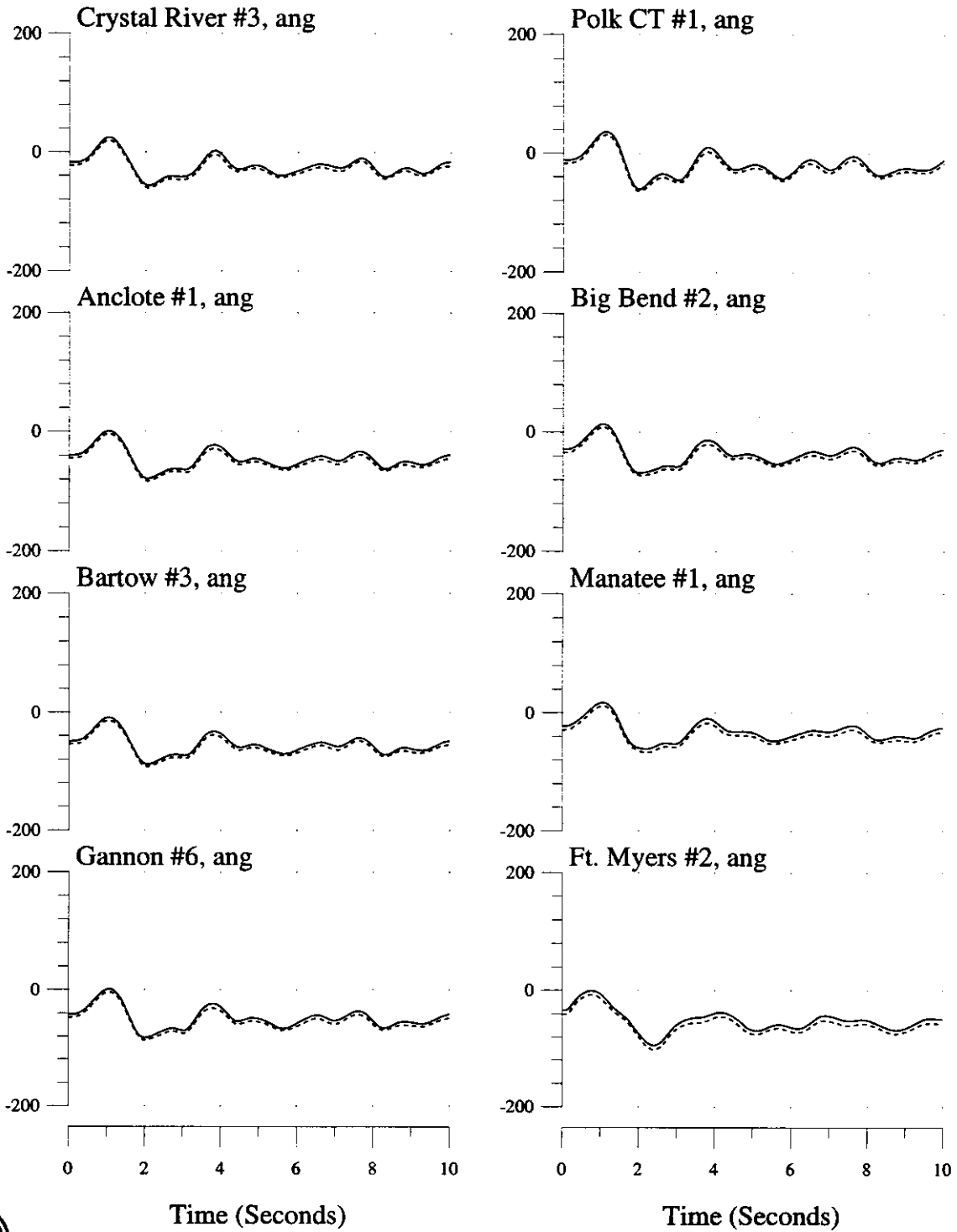

3-ph Fault at Turkey Pt 230kV Bus, Trip TP #3 & GSU @5-cy, Trip TP-Galloway 230kV Line @12cy
 2003 Summer System

Machine Variables: (—) With Okeechobee JEA Dispatch, (...) Without

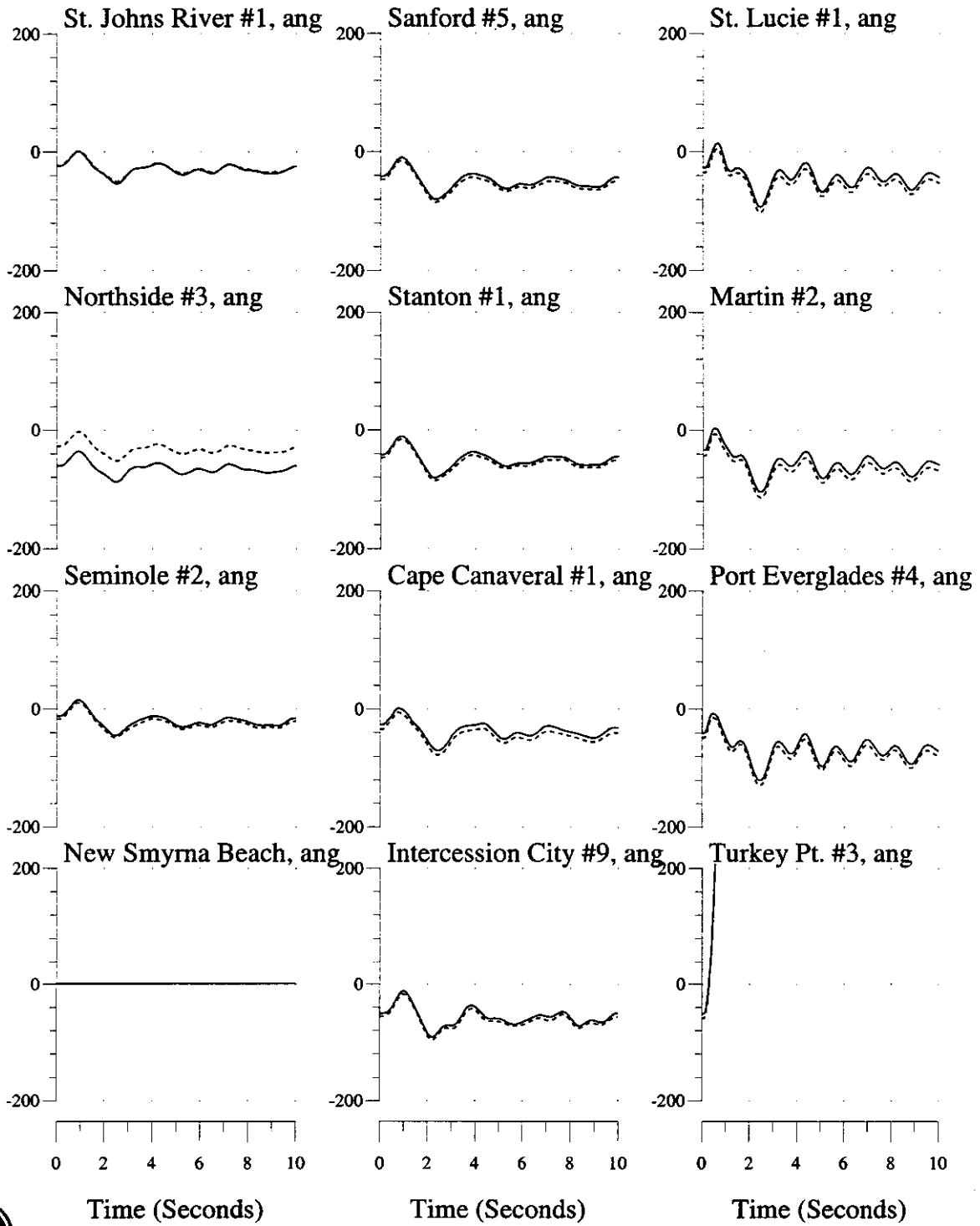

3-ph Fault at Turkey Pt 230kV Bus, Trip TP #3 & GSU @5-cy, Trip TP-Galloway 230kV Line @12cy
 2003 Summer System

Bus Variables: (—) With Okeechobee JEA Dispatch, (...) Without

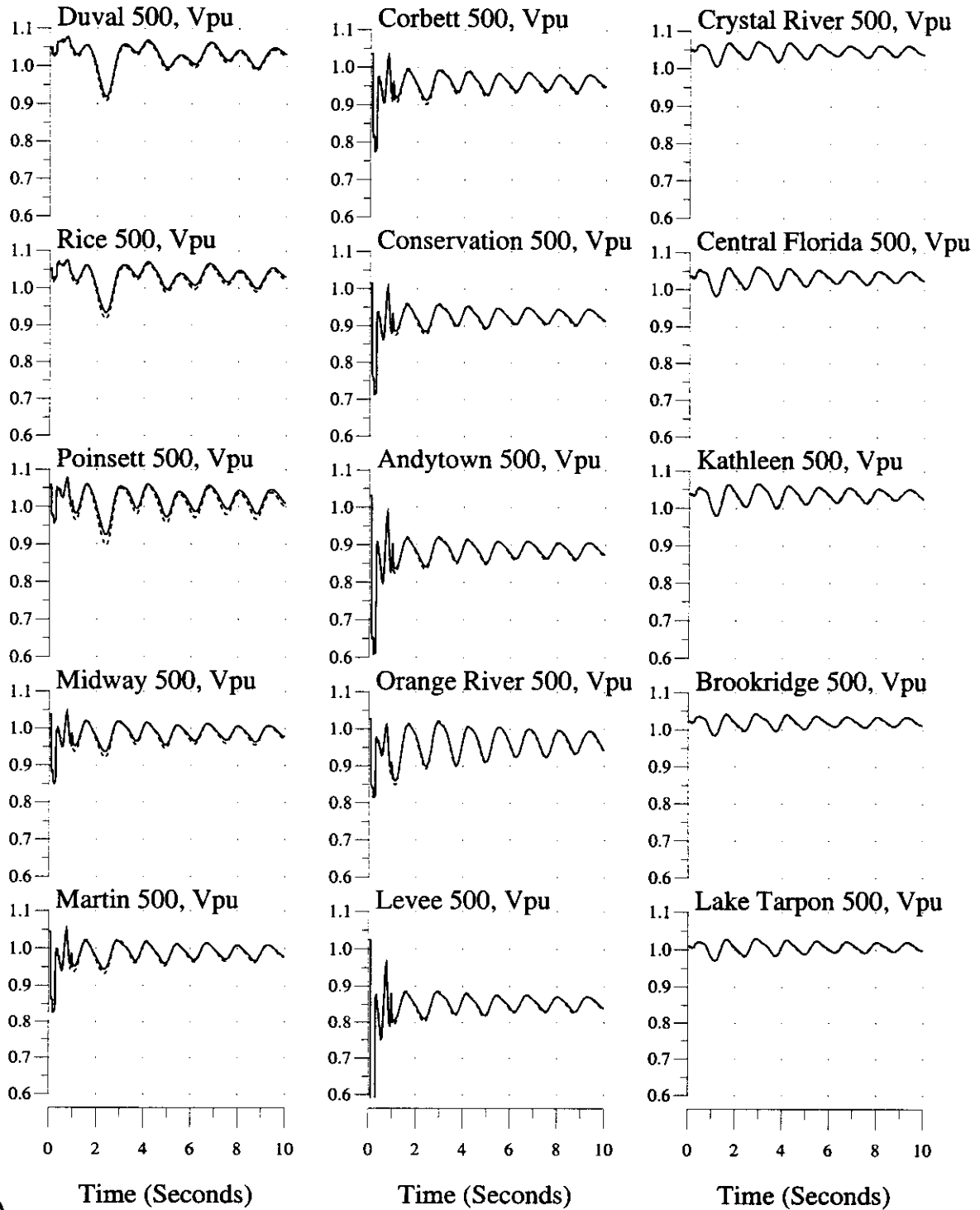

3-ph Fault at Turkey Pt 230kV Bus, Trip TP #3 & GSU @5-cy, Trip TP-Galloway 230kV Line @12cy
2003 Summer System

Bus Variables: (—) With Okeechobee JEA Dispatch, (...) Without

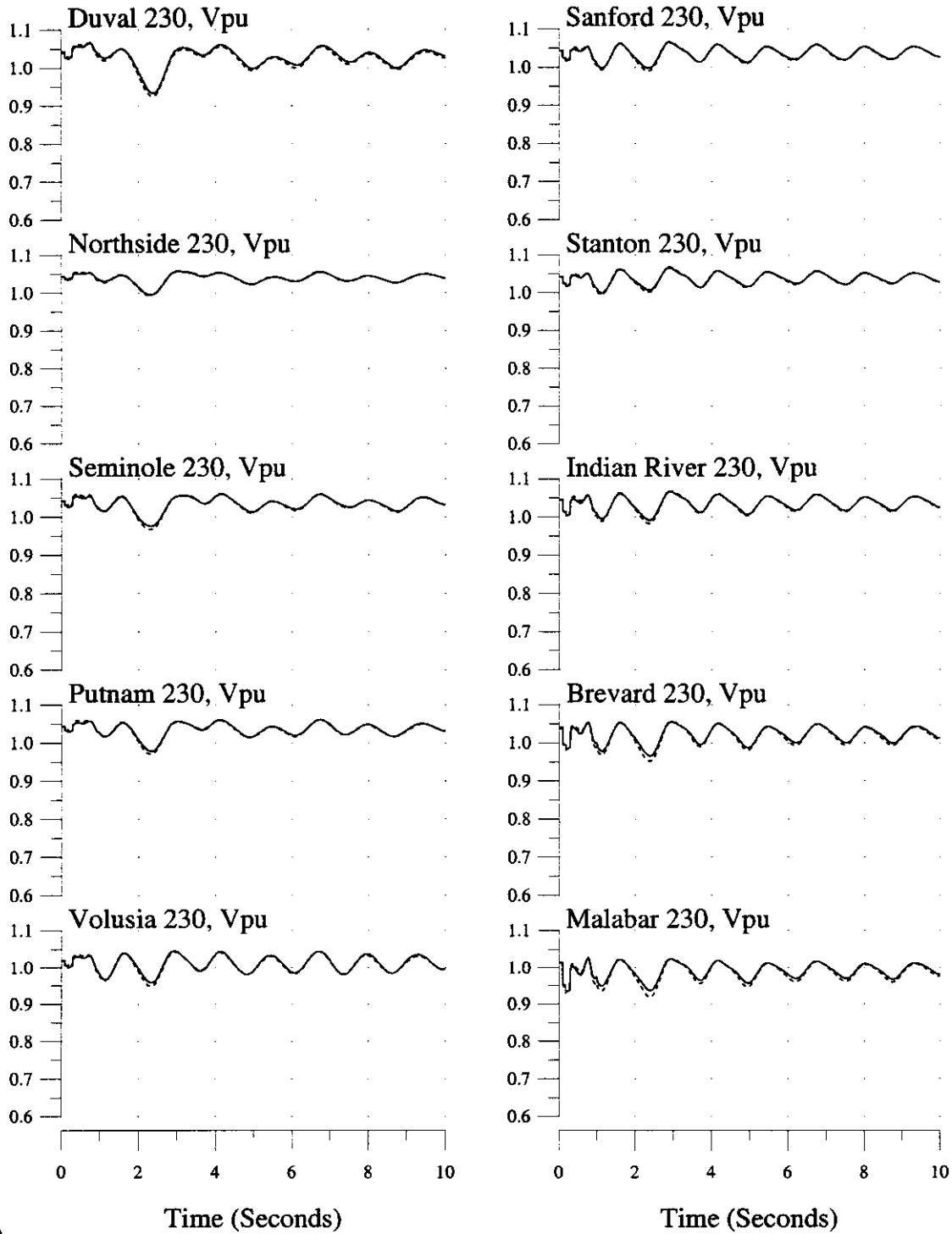

3-ph Fault at Turkey Pt 230kV Bus, Trip TP #3 & GSU @5-cy, Trip TP-Galloway 230kV Line @12cy
 2003 Summer System

Bus Variables: (—) With Okeechobee JEA Dispatch, (...) Without

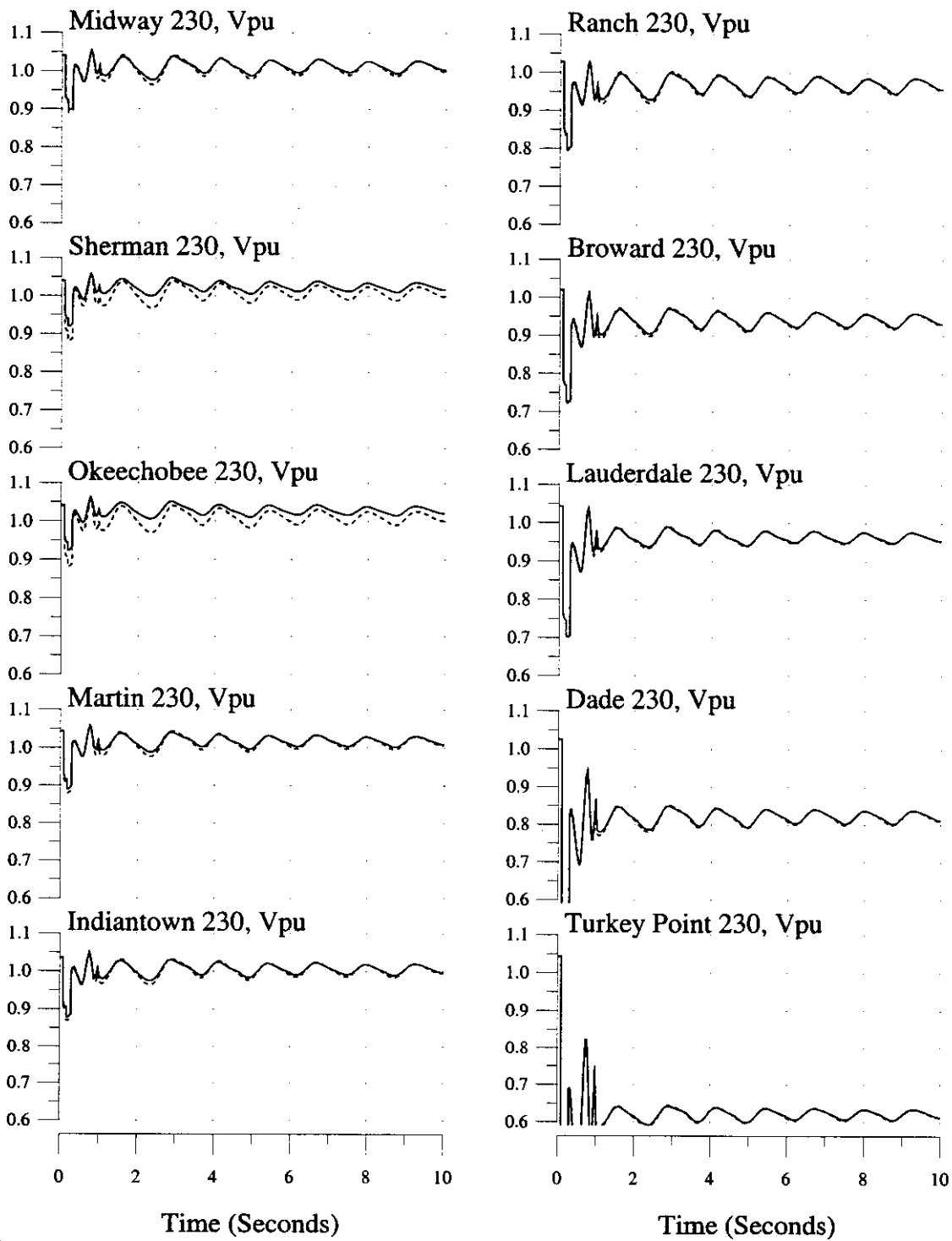

3-ph Fault at Turkey Pt 230kV Bus, Trip TP #3 & GSU @5-cy, Trip TP-Galloway 230kV Line @12cy
2003 Summer System

Bus Variables: (—) With Okeechobee JEA Dispatch, (...) Without

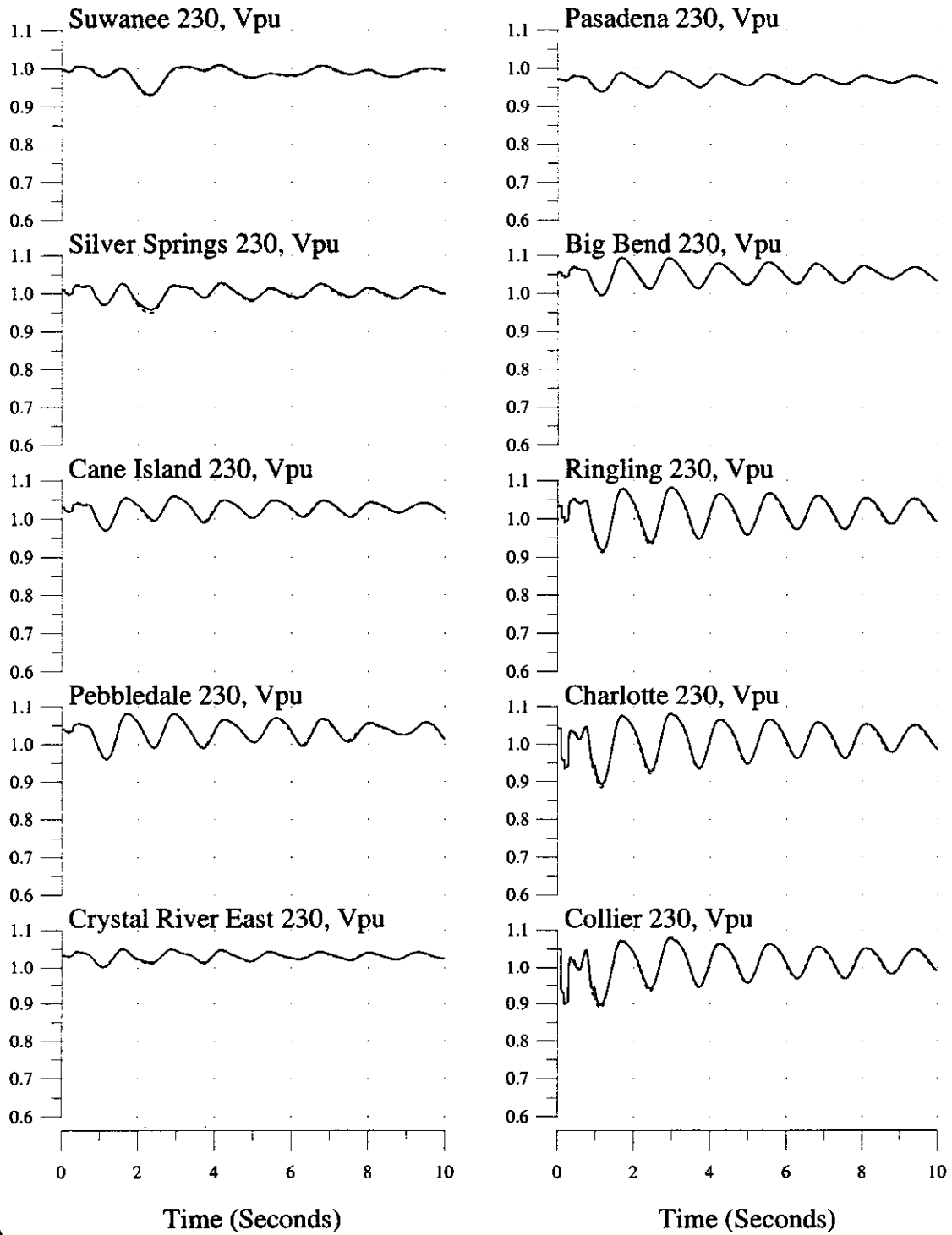

3-phase, 5-cycle Fault at St. Lucie 230kV Bus, Trip St. Lucie #1 & GSU
2003 Summer System

Machine & Interface Variables: (—) With Okeechobee So. FPL Dispatch, (...) Without

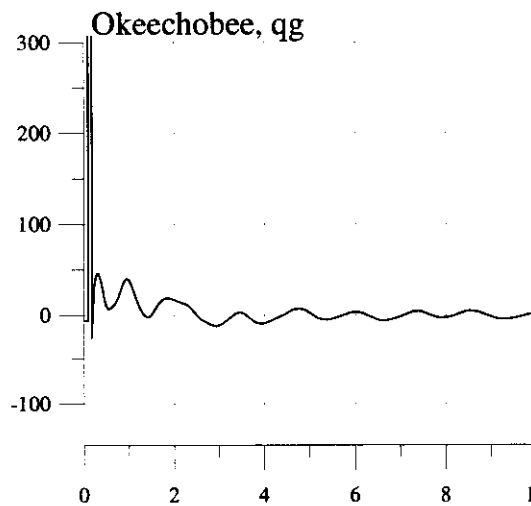
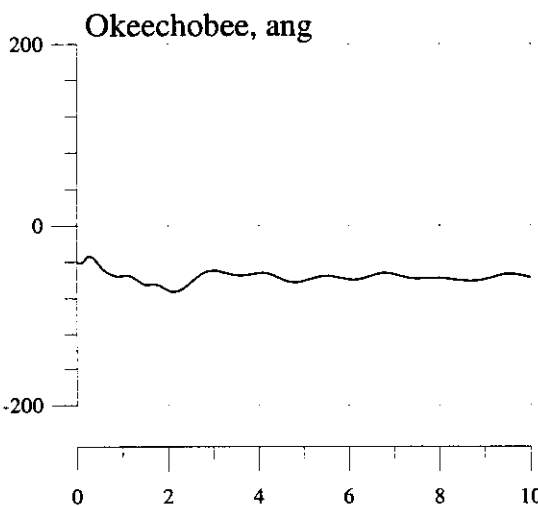
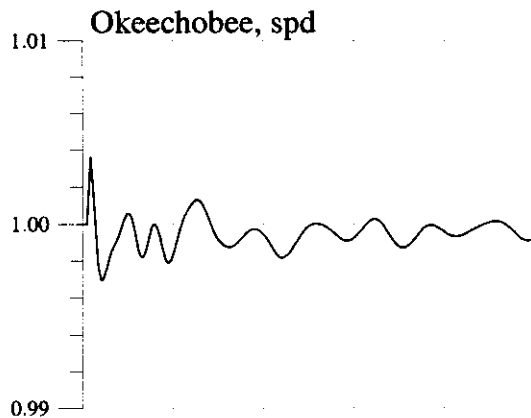
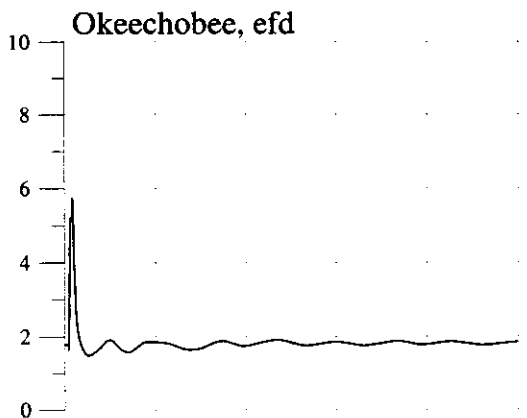
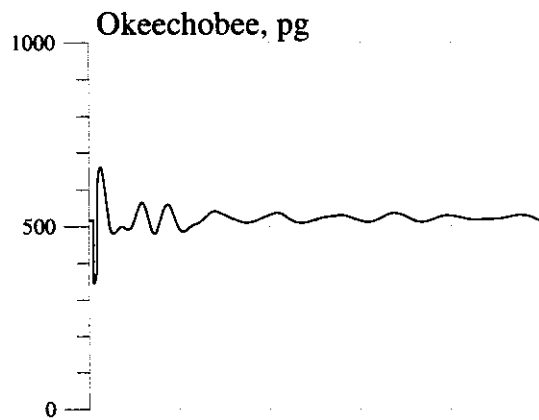
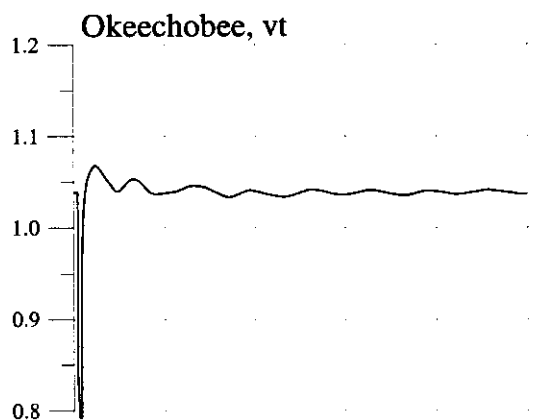

Time (Seconds)

Time (Seconds)



3-phase, 5-cycle Fault at St. Lucie 230kV Bus, Trip St. Lucie #1 & GSU
 2003 Summer System
 Machine & Interface Variables: (—) With Okeechobee So. FPL Dispatch, (...) Without

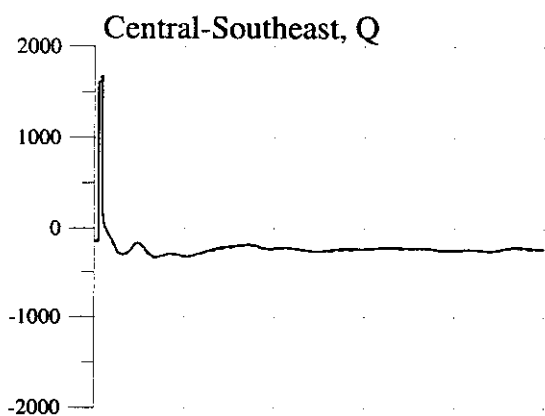
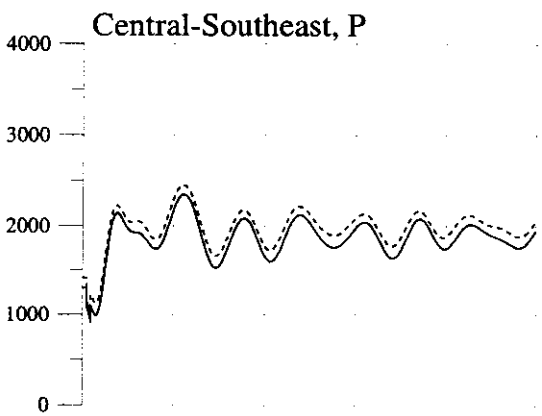
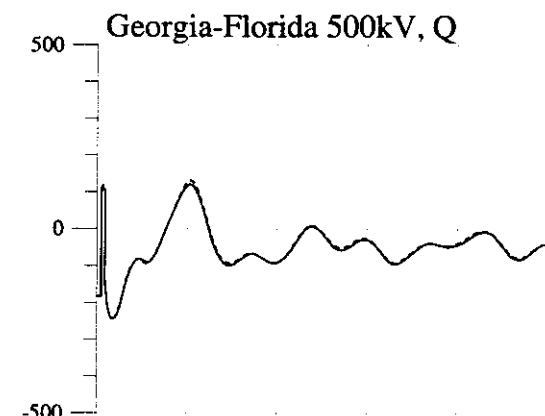
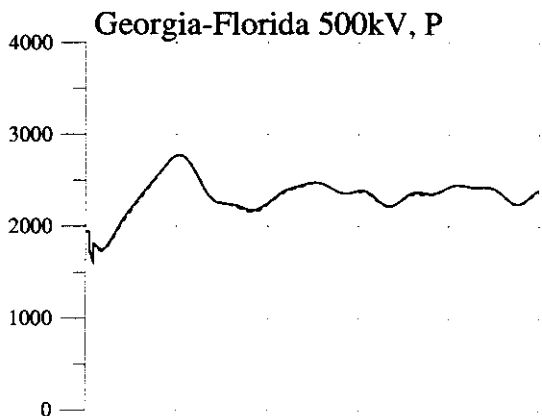
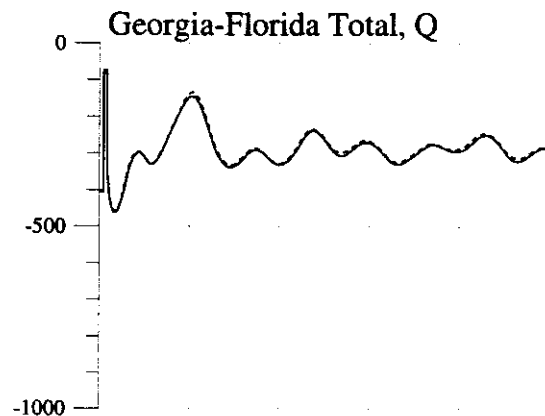
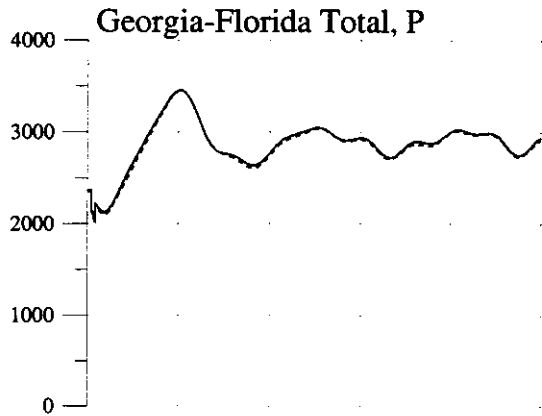

Time (Seconds)

Time (Seconds)



3-phase, 5-cycle Fault at St. Lucie 230kV Bus, Trip St. Lucie #1 & GSU
 2003 Summer System
 Machine Variables: (—) With Okeechobee So. FPL Dispatch, (...) Without

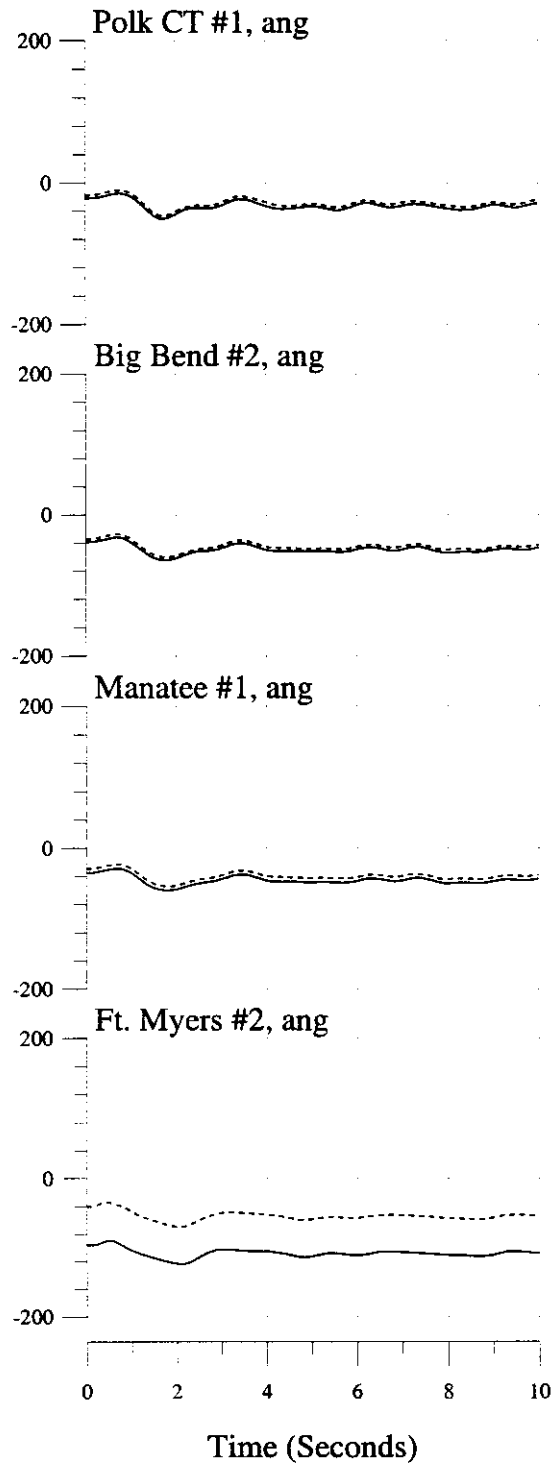
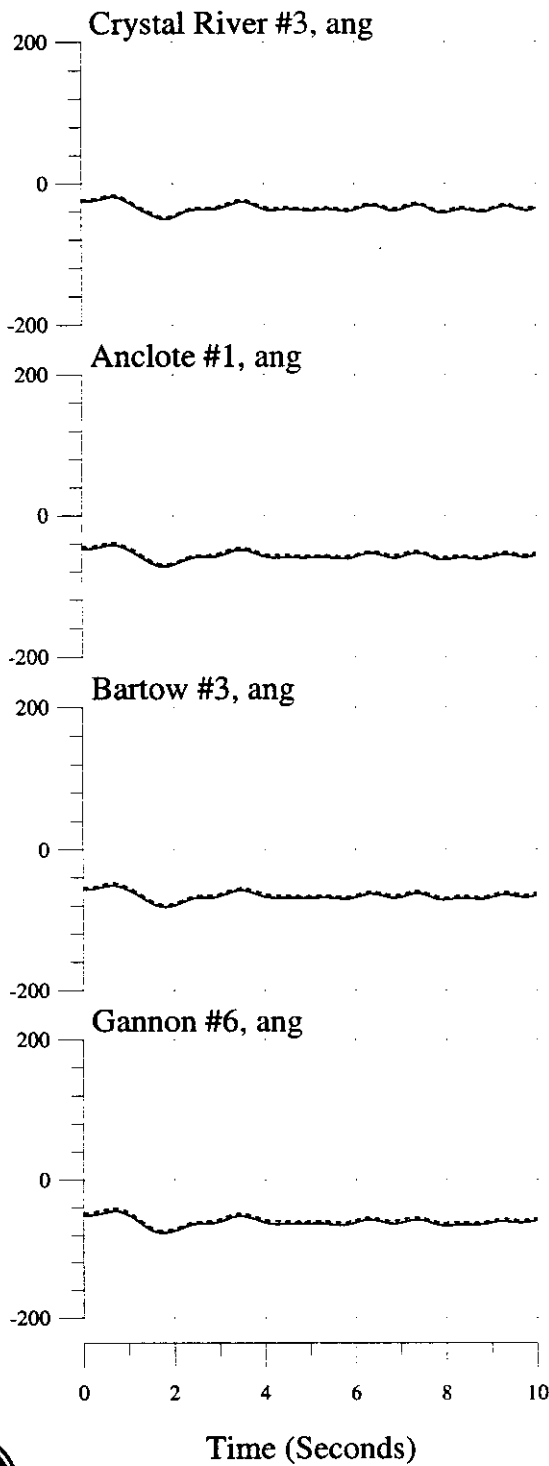

3-phase, 5-cycle Fault at St. Lucie 230kV Bus, Trip St. Lucie #1 & GSU
 2003 Summer System

Machine Variables: (___) With Okeechobee So. FPL Dispatch, (...) Without

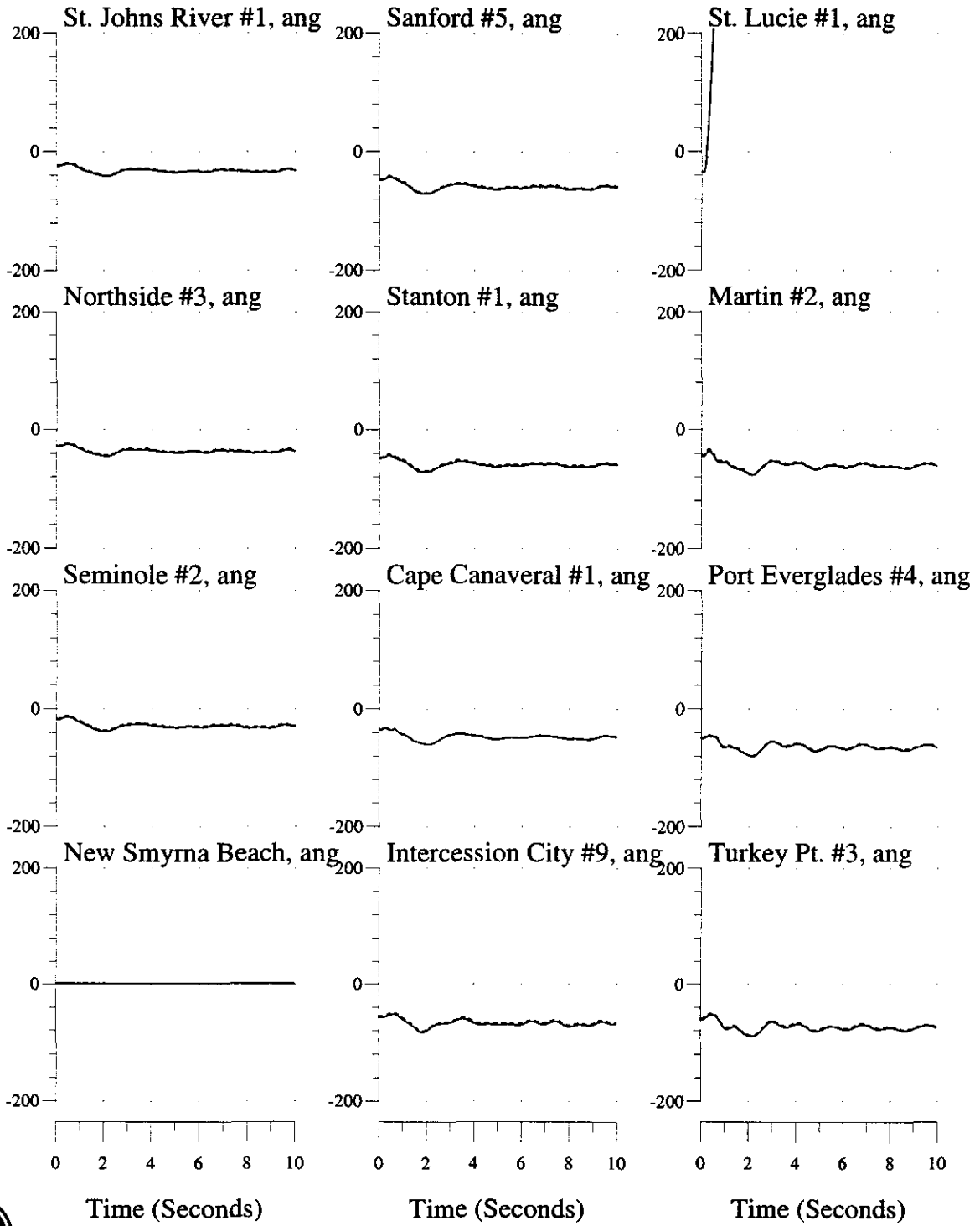

3-phase, 5-cycle Fault at St. Lucie 230kV Bus, Trip St. Lucie #1 & GSU
 2003 Summer System

Bus Variables: (—) With Okeechobee So. FPL Dispatch, (...) Without

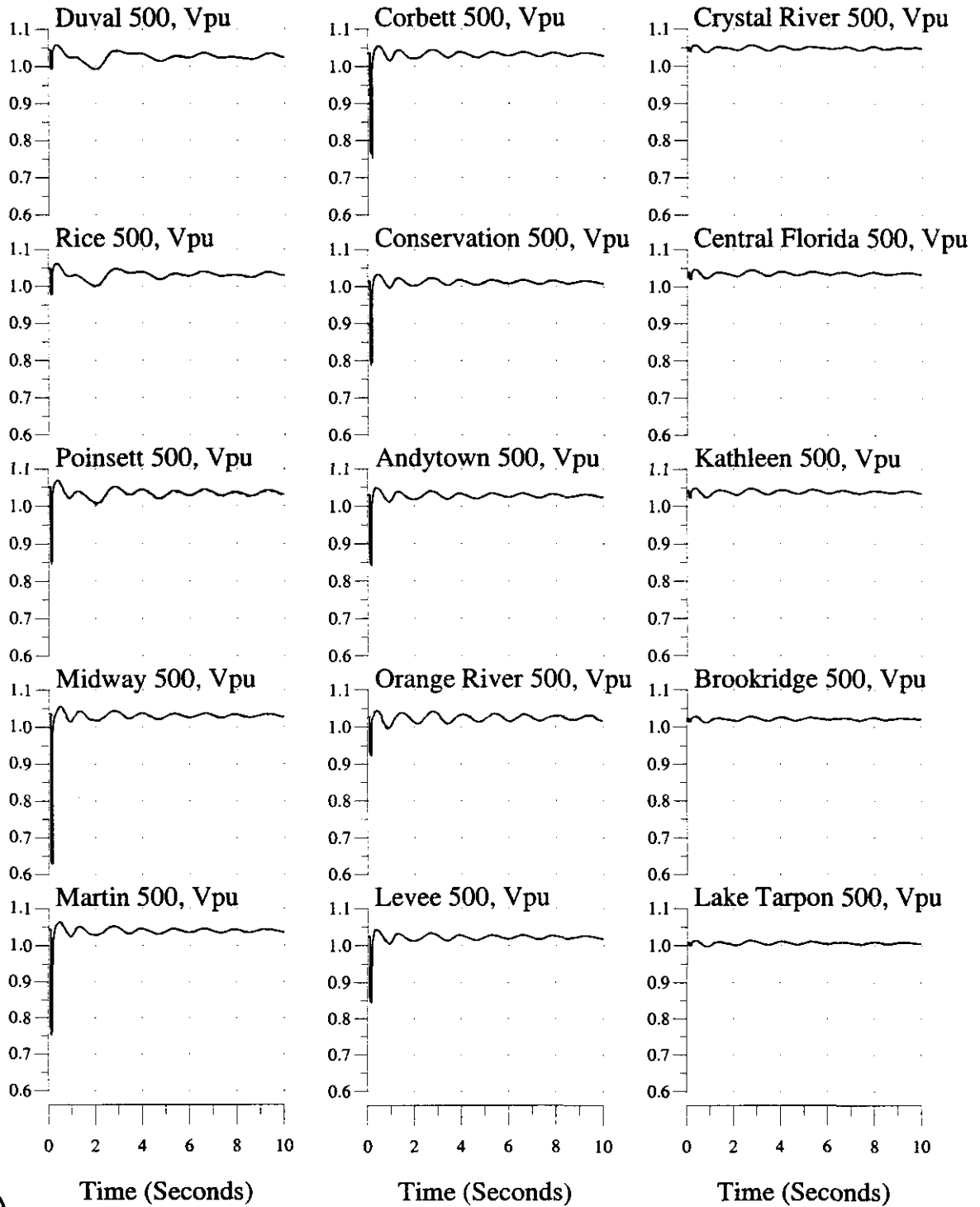

3-phase, 5-cycle Fault at St. Lucie 230kV Bus, Trip St. Lucie #1 & GSU
2003 Summer System

Bus Variables: (___) With Okeechobee So. FPL Dispatch, (...) Without

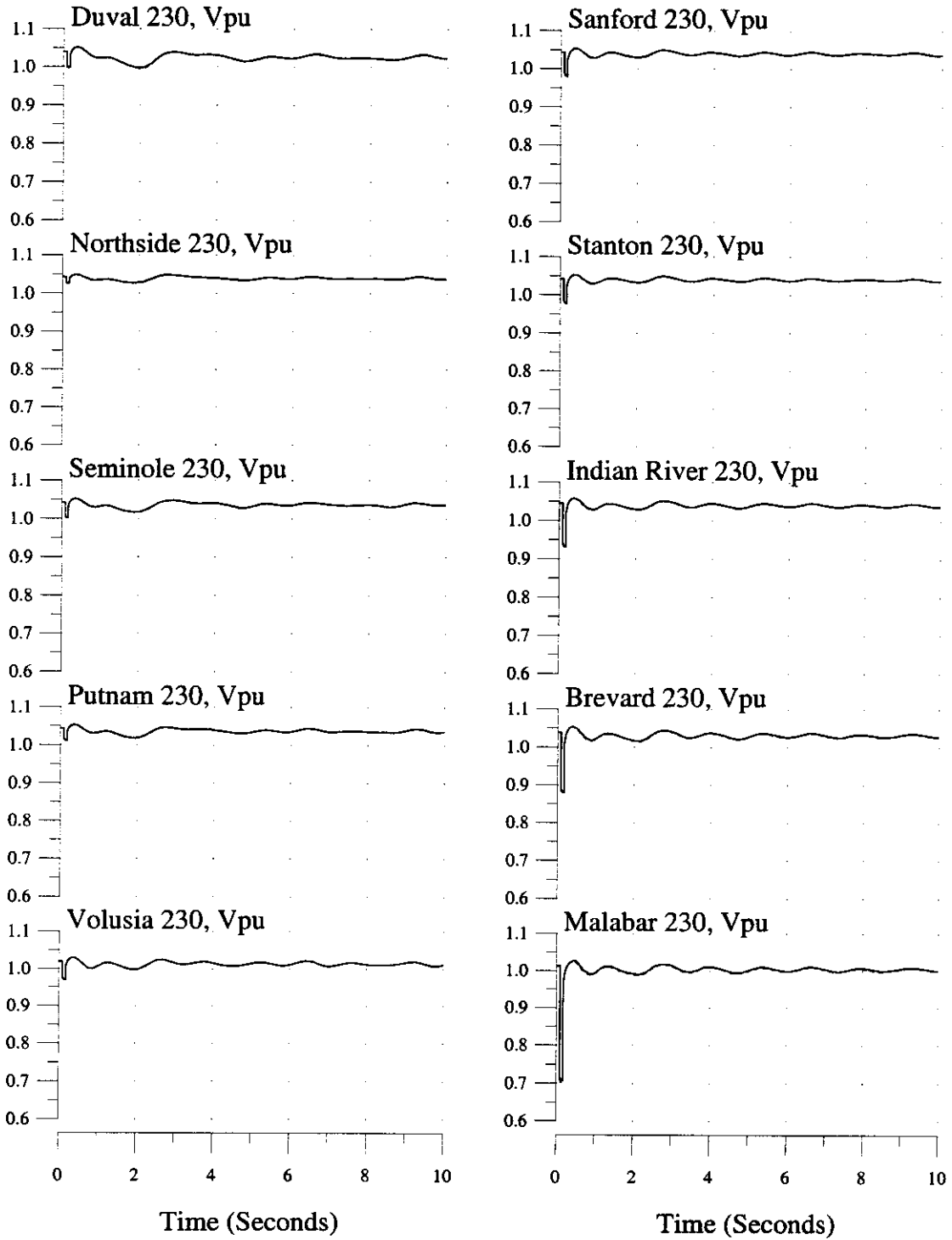

3-phase, 5-cycle Fault at St. Lucie 230kV Bus, Trip St. Lucie #1 & GSU
2003 Summer System

Bus Variables: (___) With Okeechobee So. FPL Dispatch, (...) Without

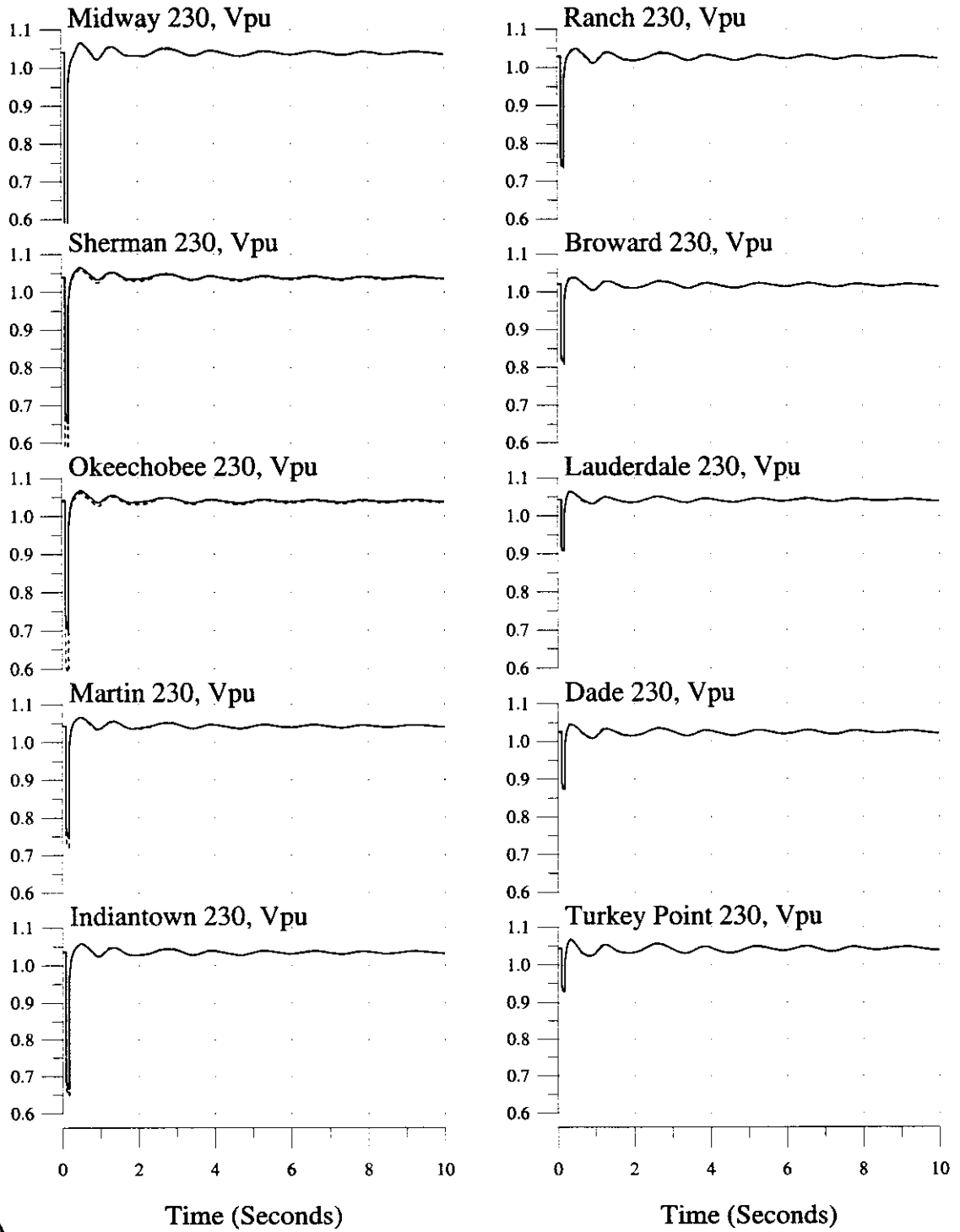

3-phase, 5-cycle Fault at St. Lucie 230kV Bus, Trip St. Lucie #1 & GSU
2003 Summer System

Bus Variables: (___) With Okeechobee So. FPL Dispatch, (...) Without

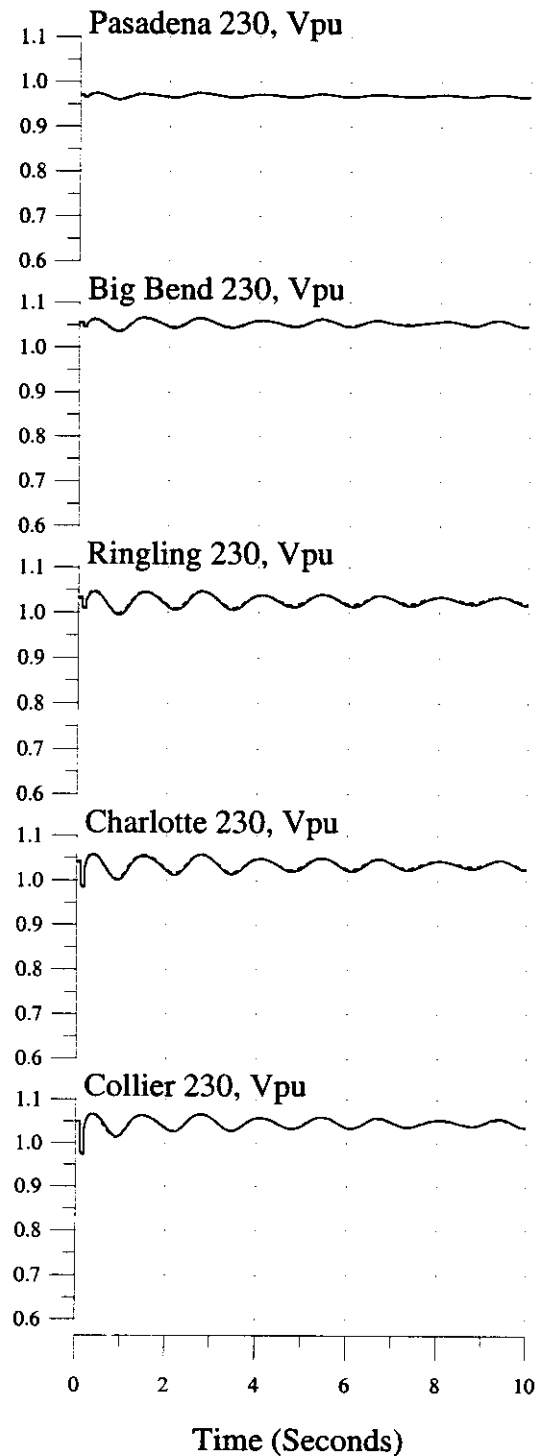
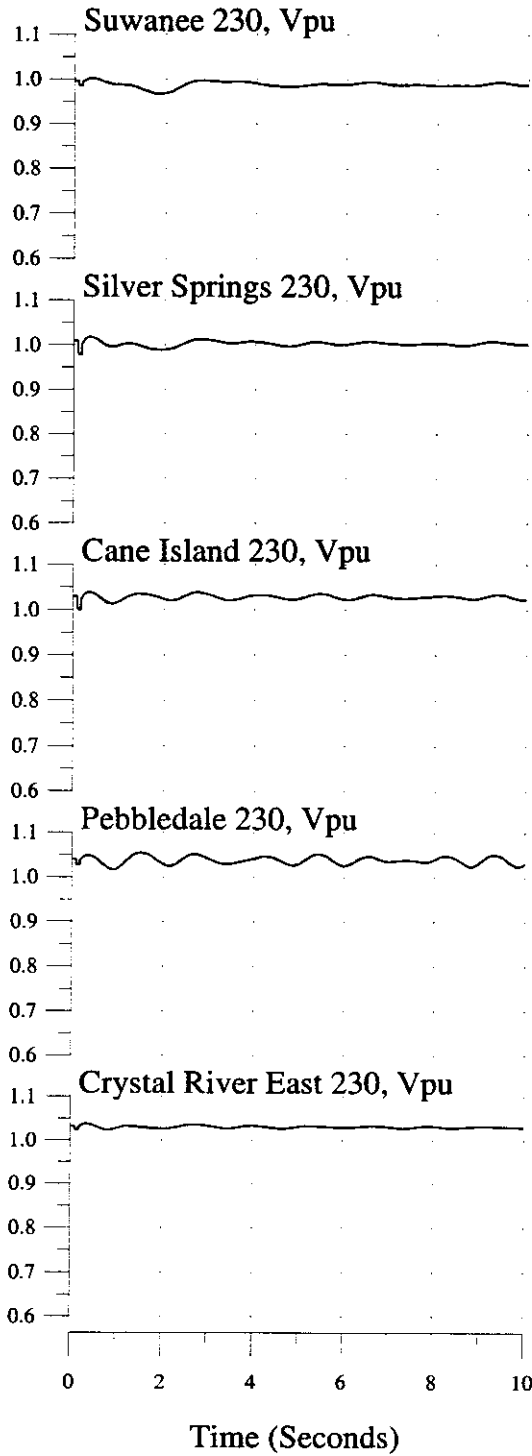

3-phase, 5-cycle Fault at Turkey Pt 230kV Bus, Trip Turkey Pt #3 & GSU
2003 Summer System

Machine & Interface Variables: (—) With Okeechobee So. FPL Dispatch, (...) Without

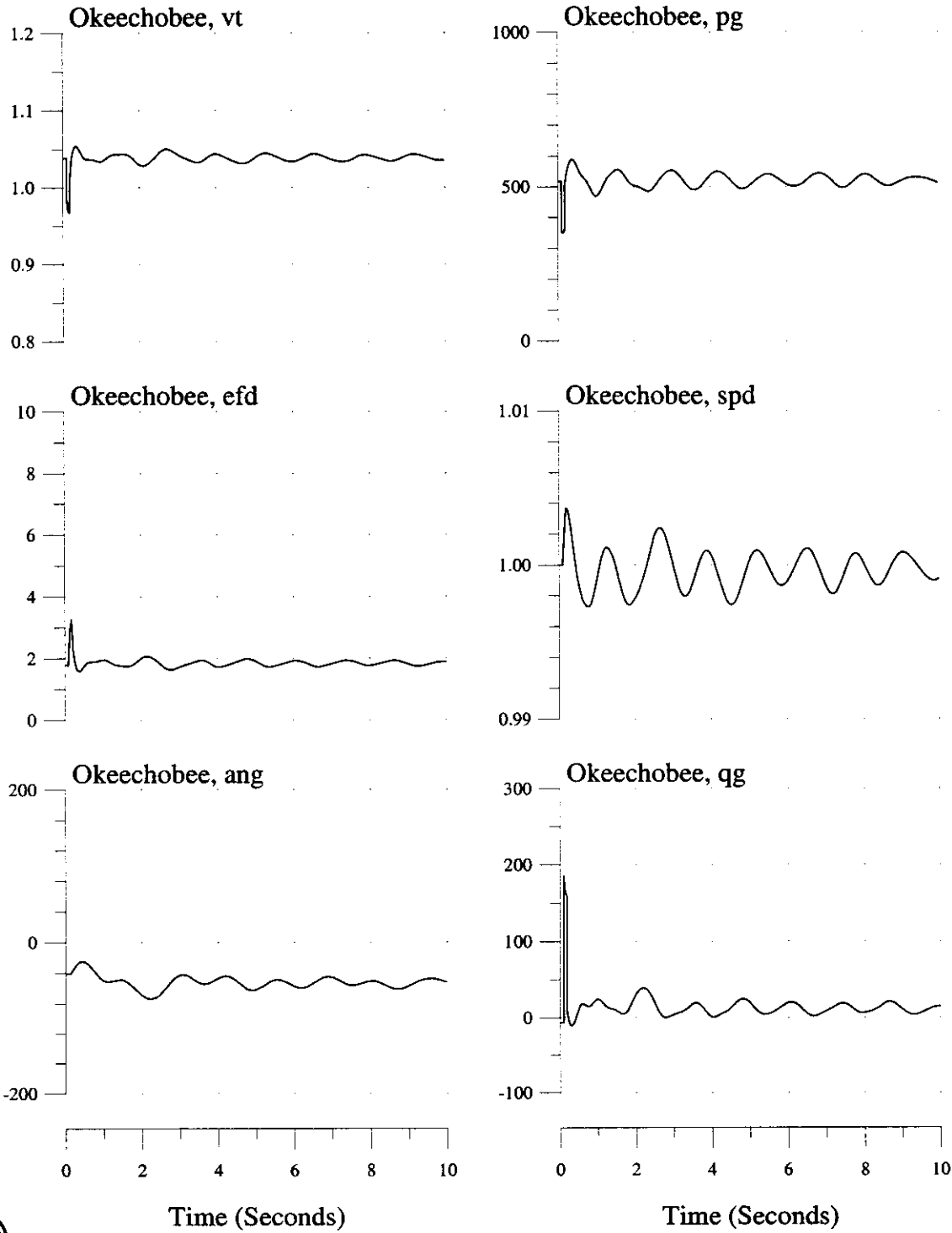

3-phase, 5-cycle Fault at Turkey Pt 230kV Bus, Trip Turkey Pt #3 & GSU
2003 Summer System

Machine & Interface Variables: (—) With Okeechobee So. FPL Dispatch, (...) Without

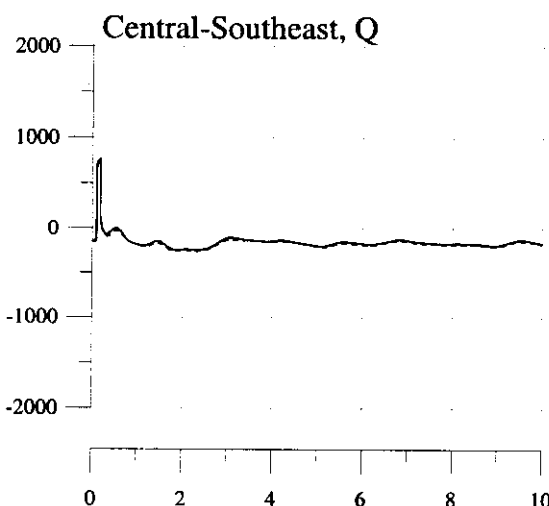
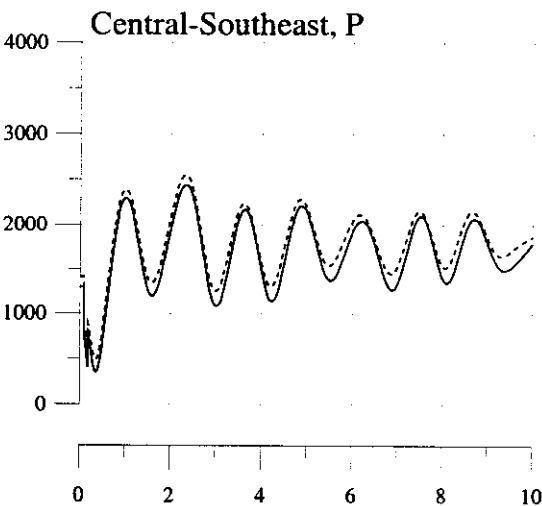
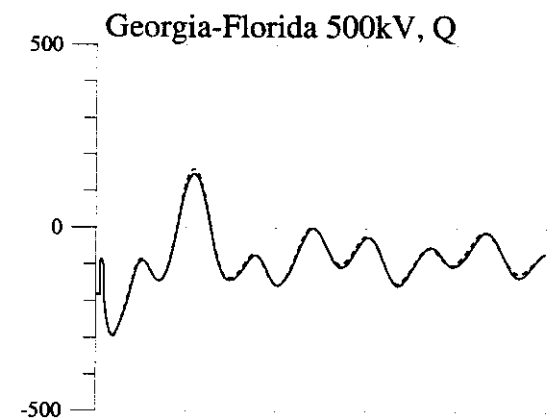
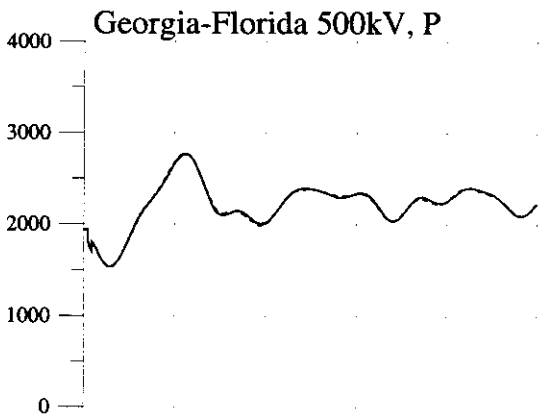
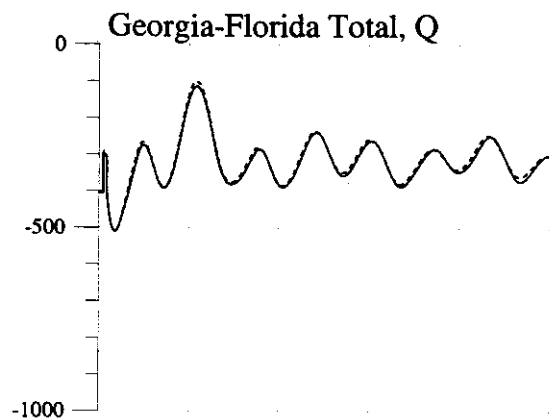
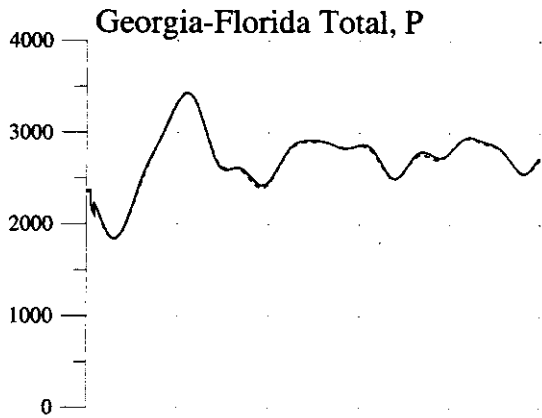

Time (Seconds)

Time (Seconds)



3-phase, 5-cycle Fault at Turkey Pt 230kV Bus, Trip Turkey Pt #3 & GSU
 2003 Summer System
 Machine Variables: (—) With Okeechobee So. FPL Dispatch, (...) Without

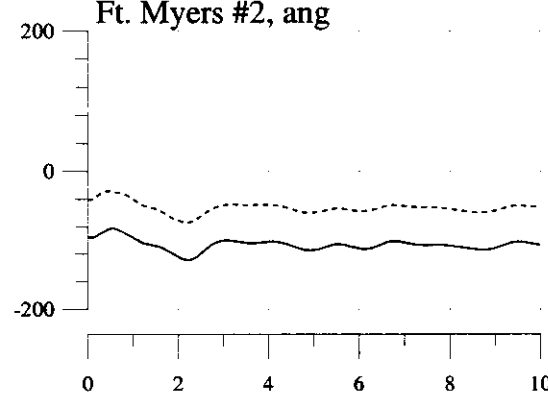
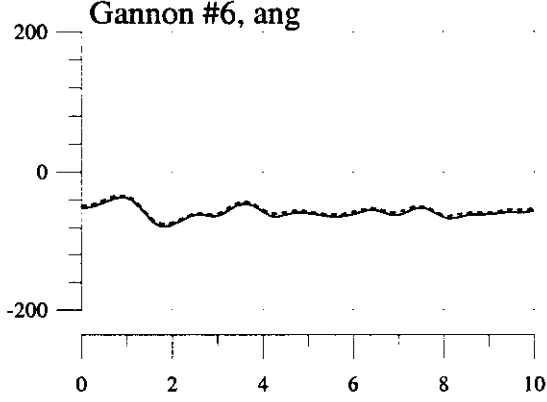
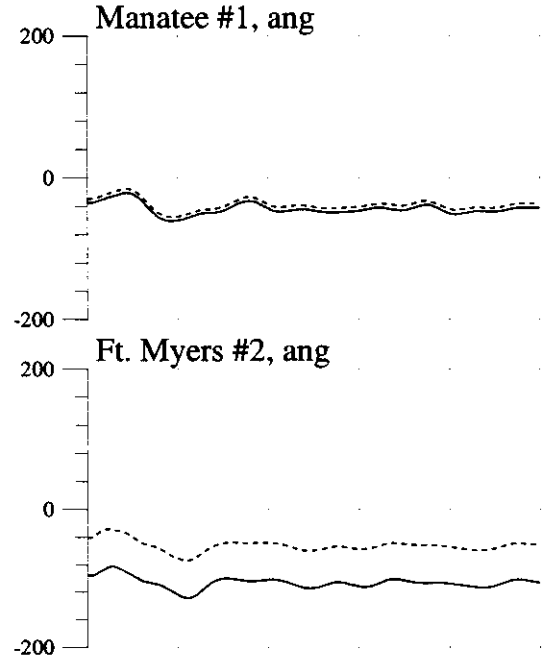
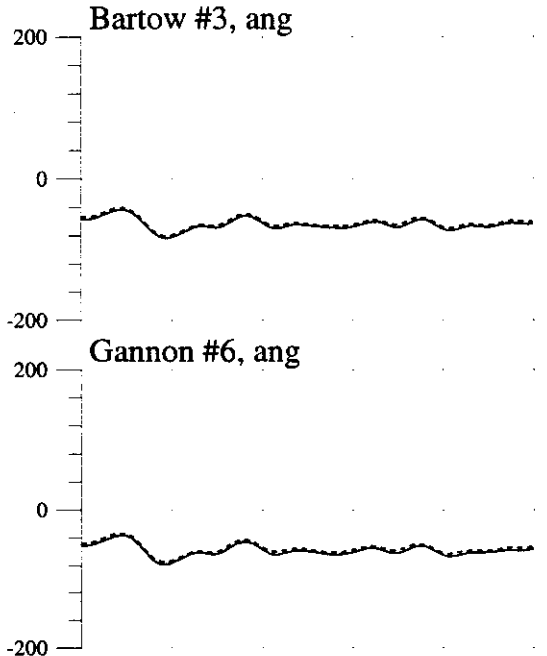
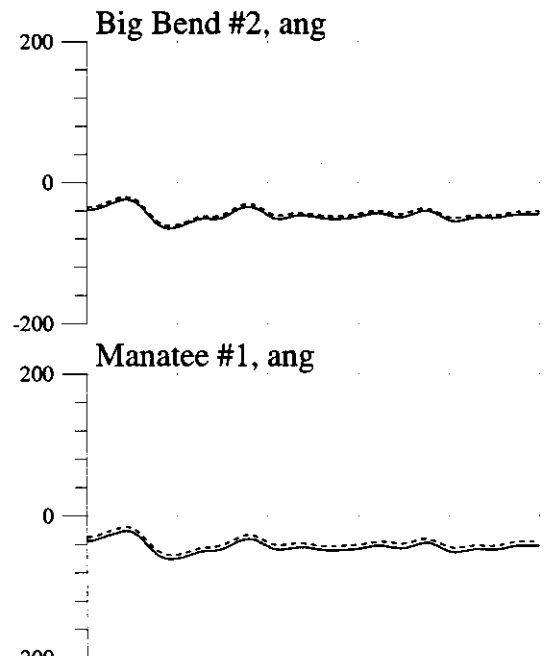
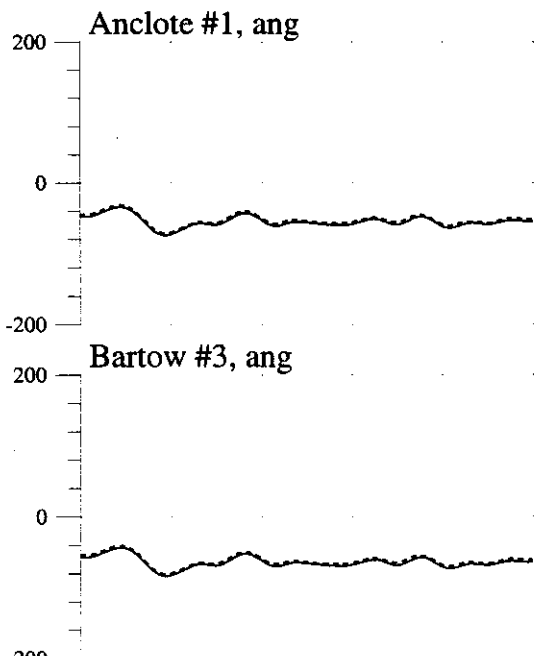
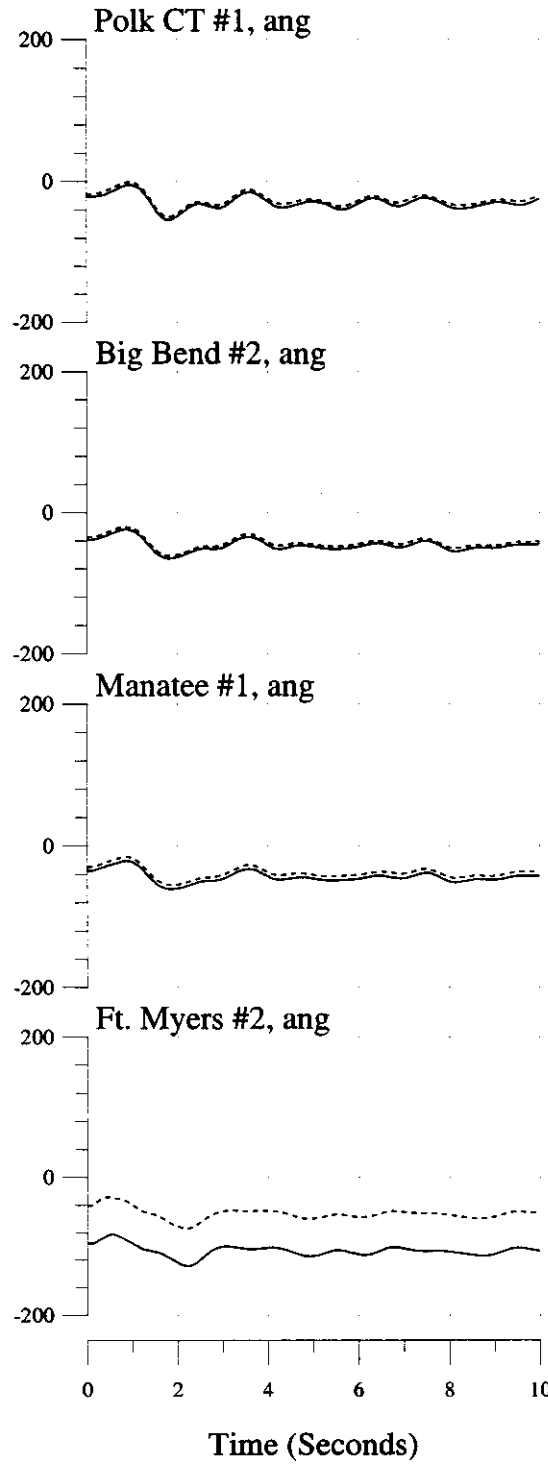
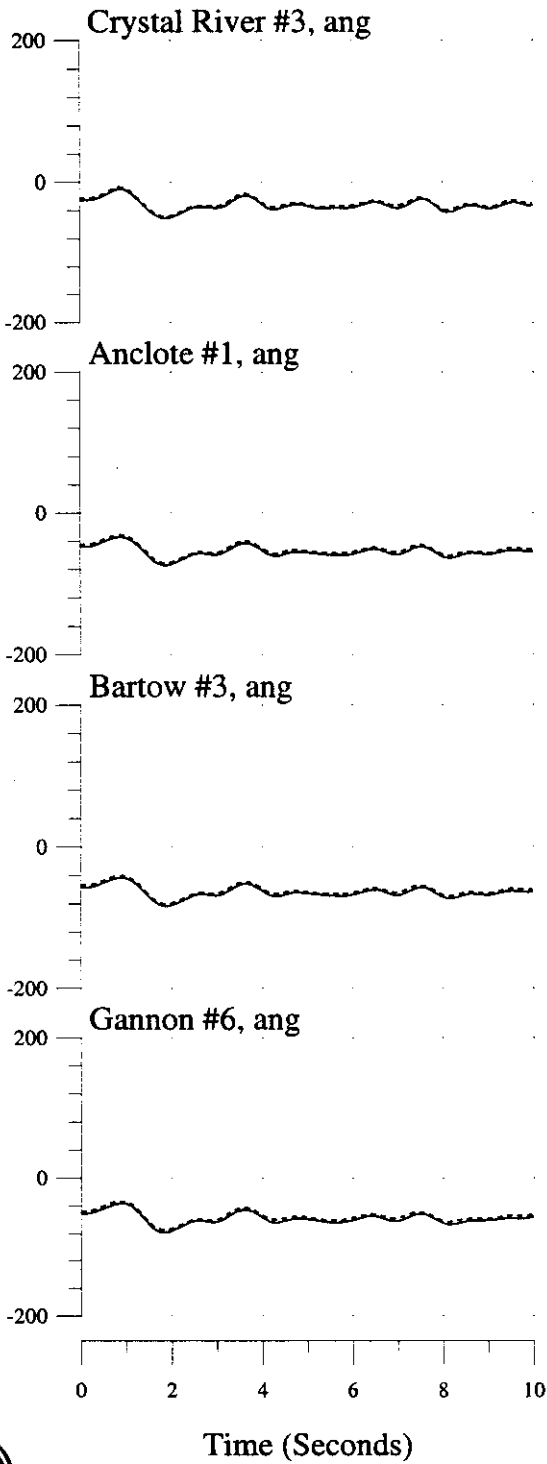

3-phase, 5-cycle Fault at Turkey Pt 230kV Bus, Trip Turkey Pt #3 & GSU
 2003 Summer System

Machine Variables: (___) With Okeechobee So. FPL Dispatch, (...) Without

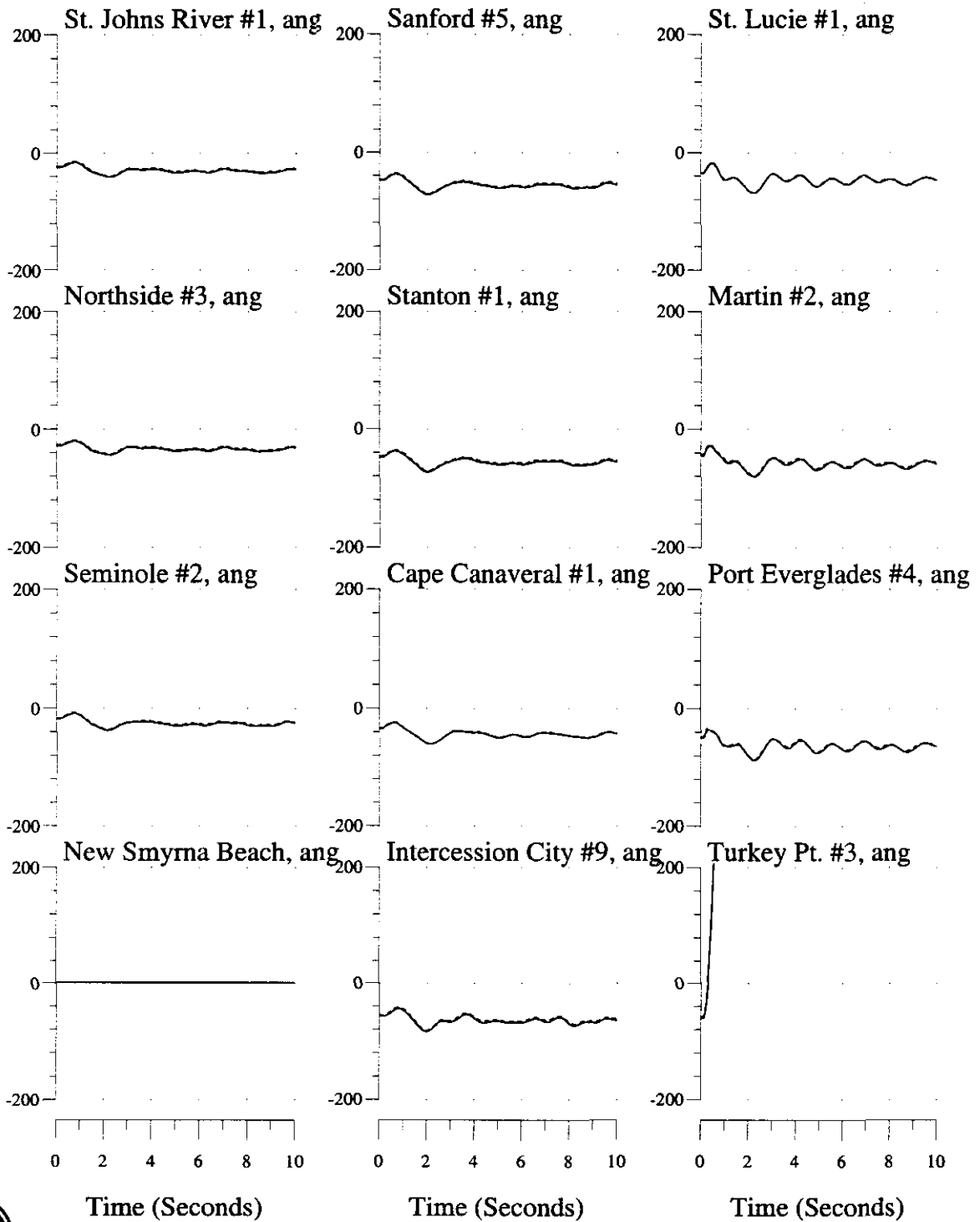

3-phase, 5-cycle Fault at Turkey Pt 230kV Bus, Trip Turkey Pt #3 & GSU
 2003 Summer System

Bus Variables: (—) With Okeechobee So. FPL Dispatch, (...) Without

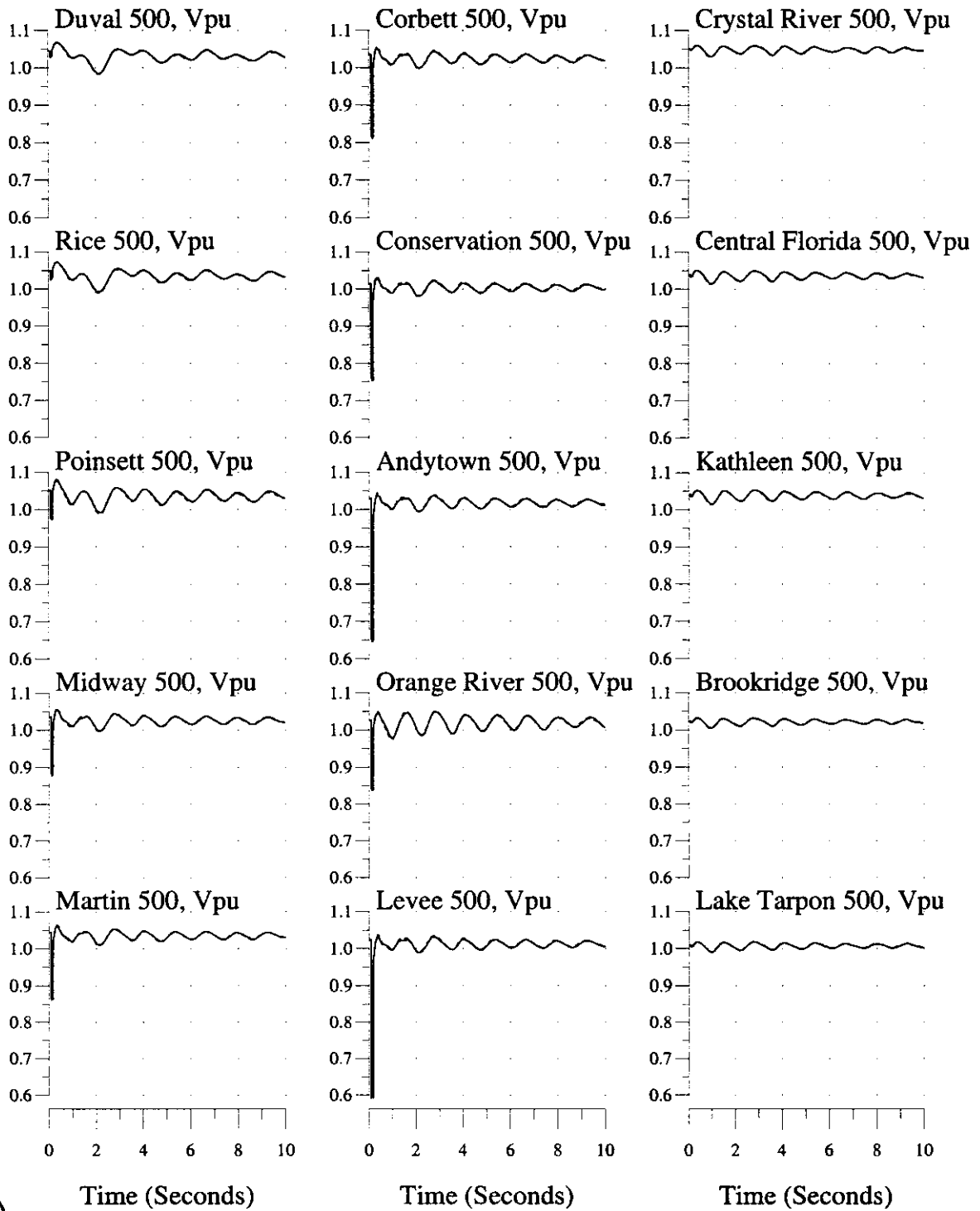

3-phase, 5-cycle Fault at Turkey Pt 230kV Bus, Trip Turkey Pt #3 & GSU
2003 Summer System

Bus Variables: (___) With Okeechobee So. FPL Dispatch, (...) Without

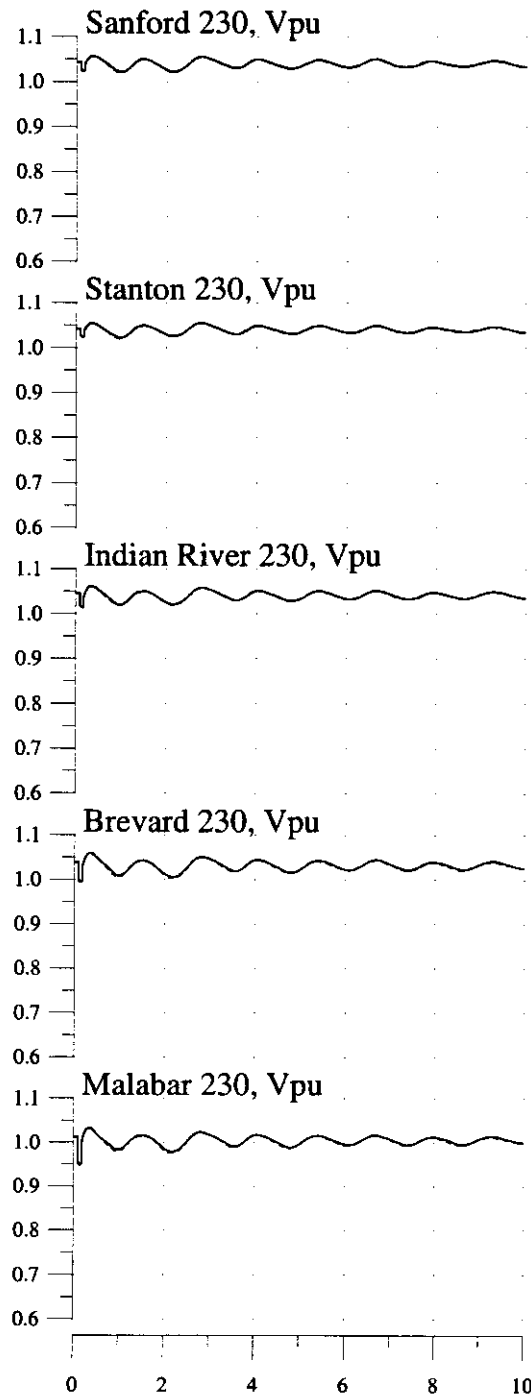
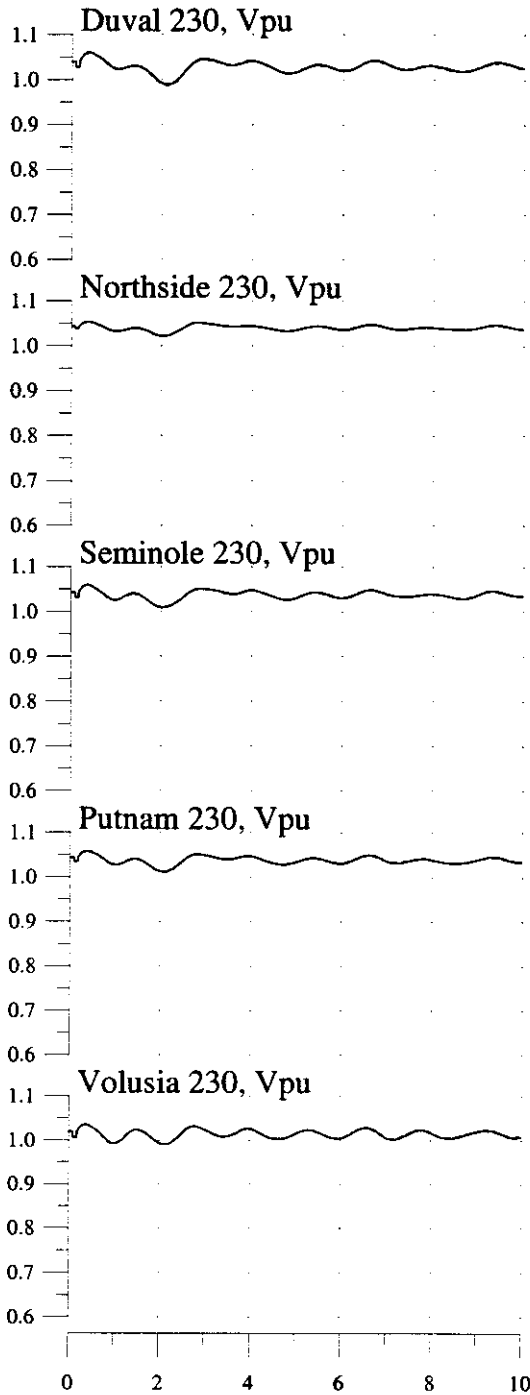

Time (Seconds)

Time (Seconds)



3-phase, 5-cycle Fault at Turkey Pt 230kV Bus, Trip Turkey Pt #3 & GSU
2003 Summer System

Bus Variables: (___) With Okeechobee So. FPL Dispatch, (...) Without

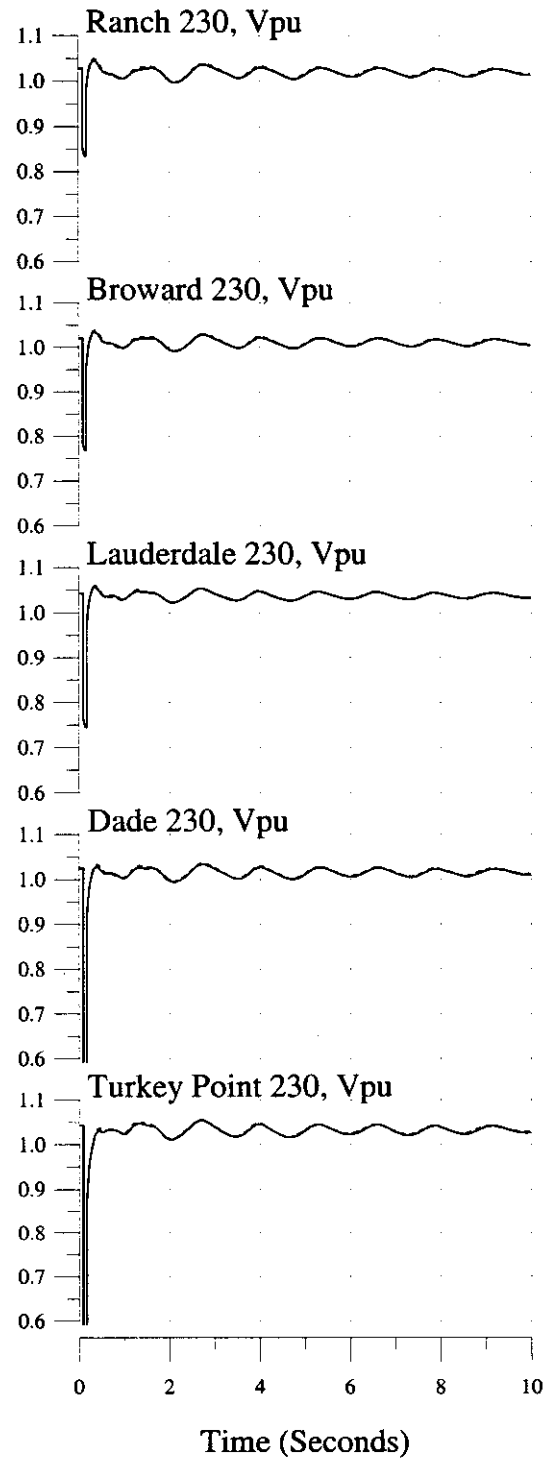
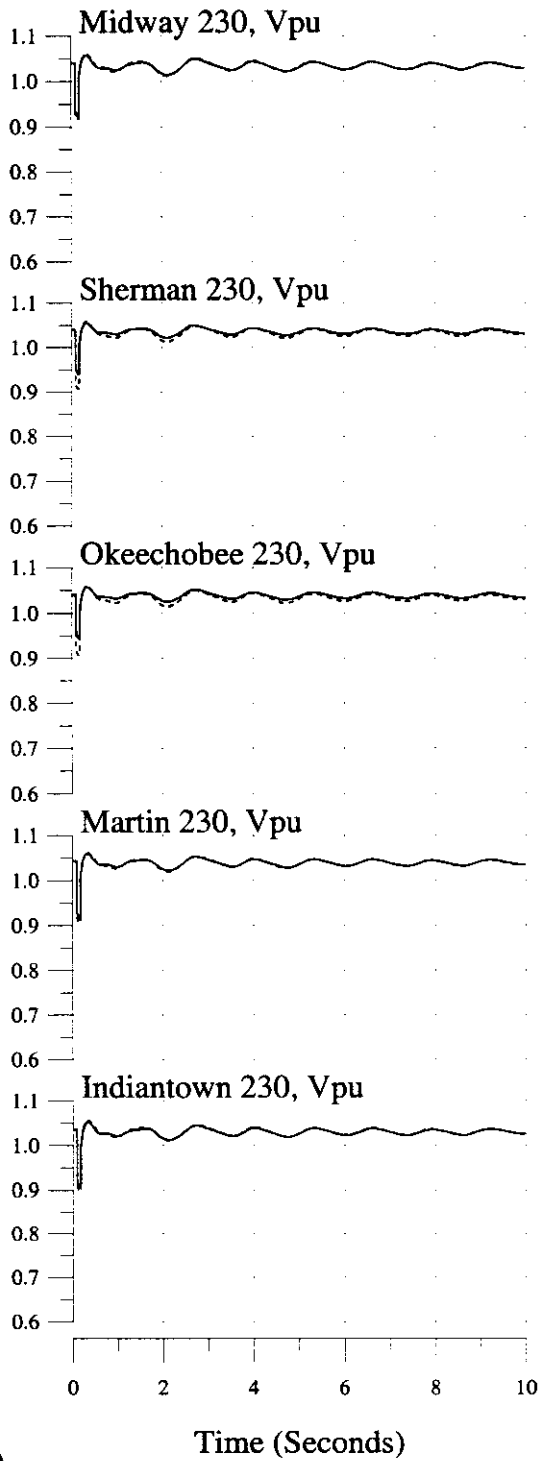

3-phase, 5-cycle Fault at Turkey Pt 230kV Bus, Trip Turkey Pt #3 & GSU
 2003 Summer System

Bus Variables: (___) With Okeechobee So. FPL Dispatch, (...) Without

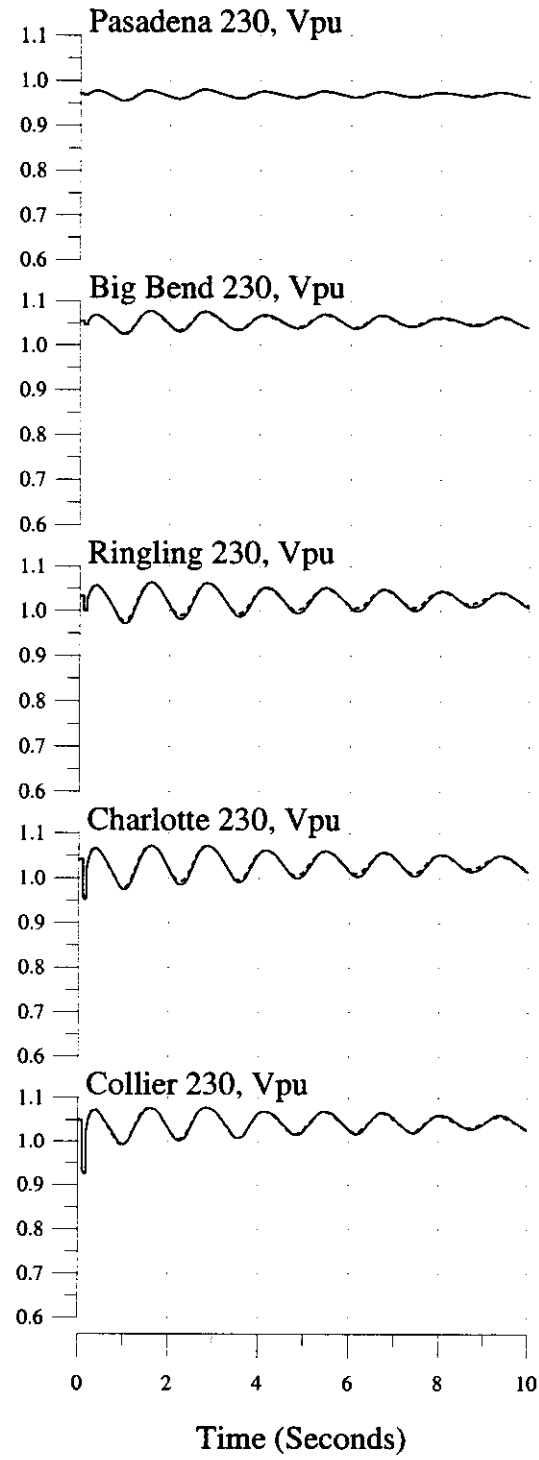
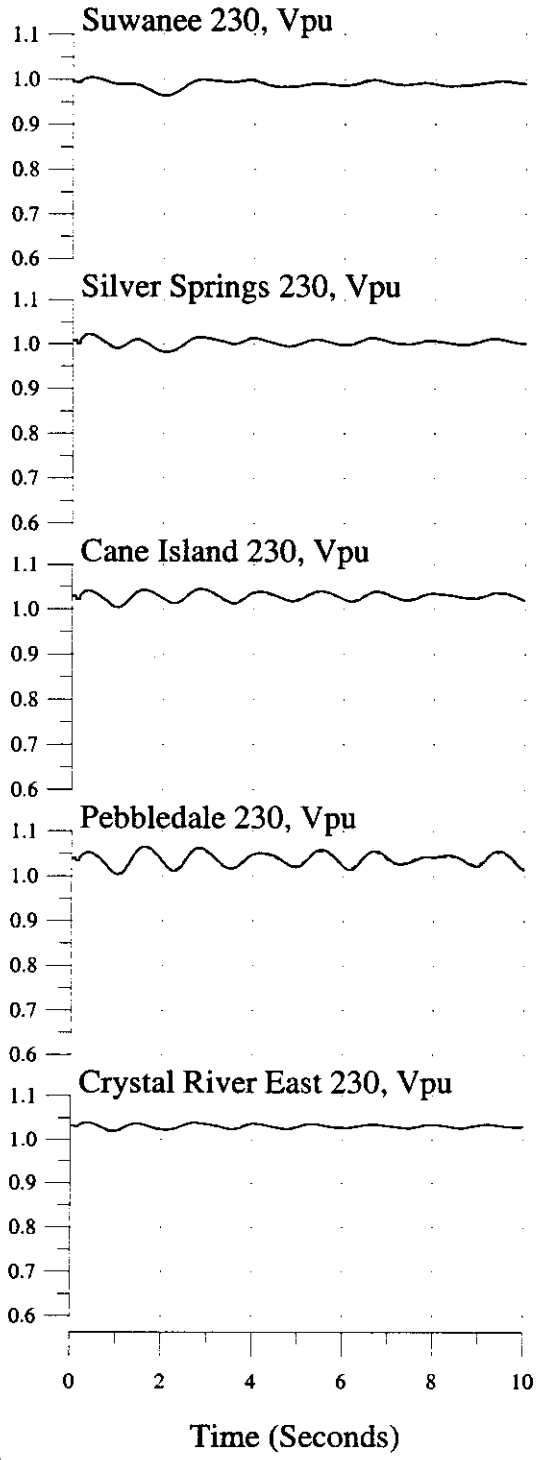

3-phase, 5-cycle Fault at Seminole 230kV Bus, Trip Seminole #1 & GSU
2003 Summer System

Machine & Interface Variables: (—) With Okeechobee So. FPL Dispatch, (...) Without

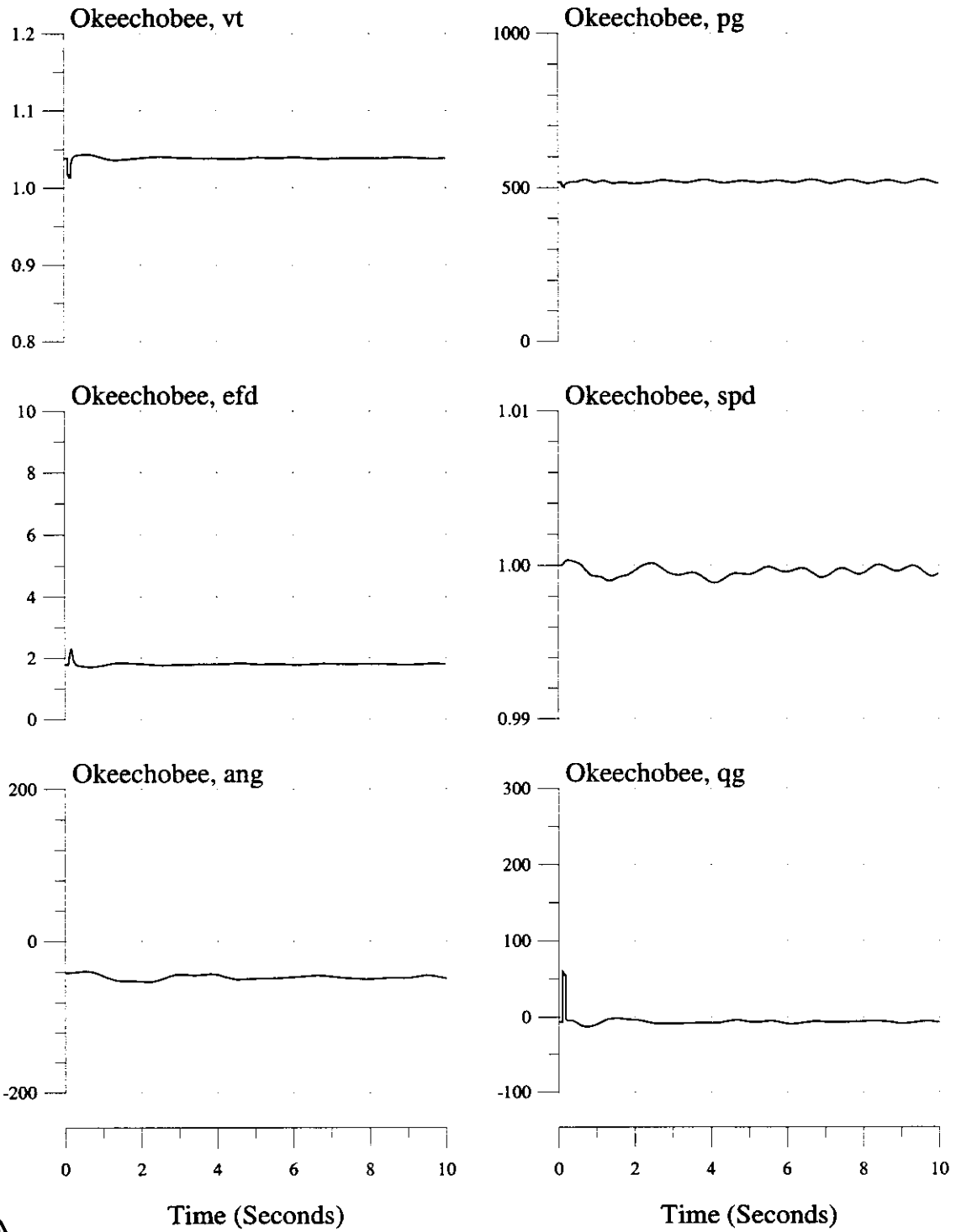

3-phase, 5-cycle Fault at Seminole 230kV Bus, Trip Seminole #1 & GSU
2003 Summer System

Machine & Interface Variables: (—) With Okeechobee So. FPL Dispatch, (...) Without

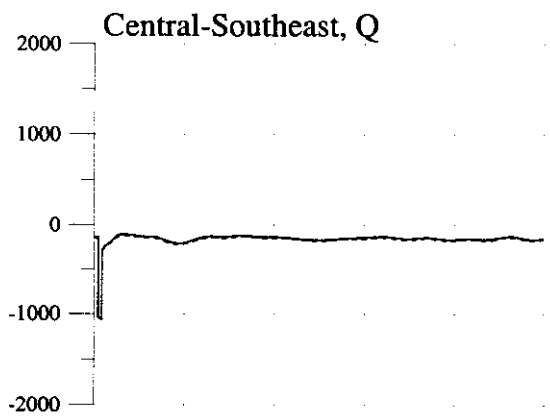
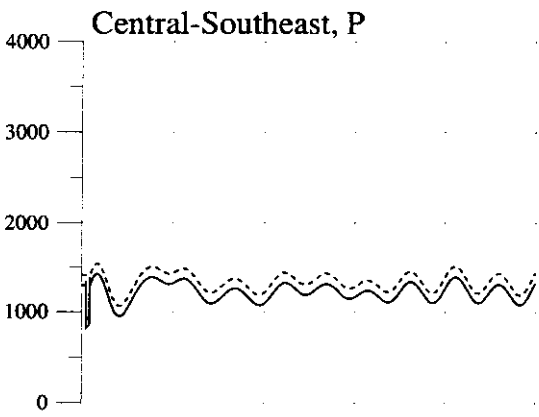
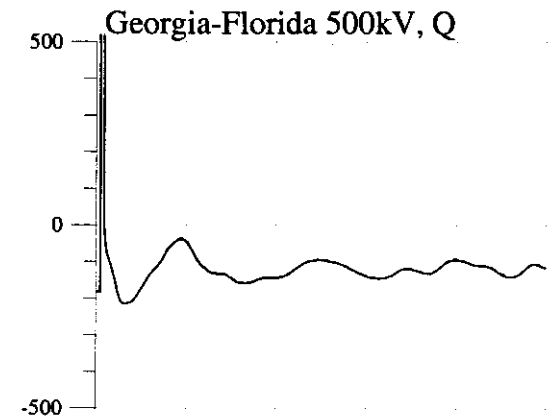
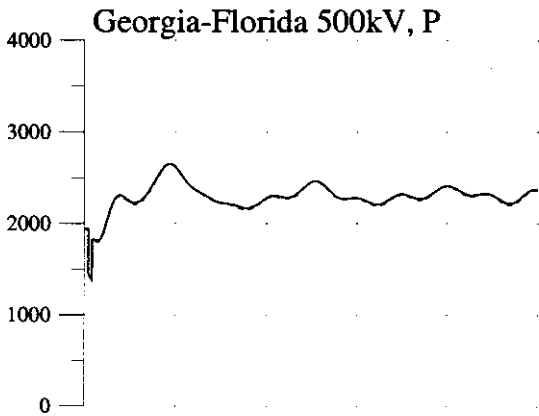
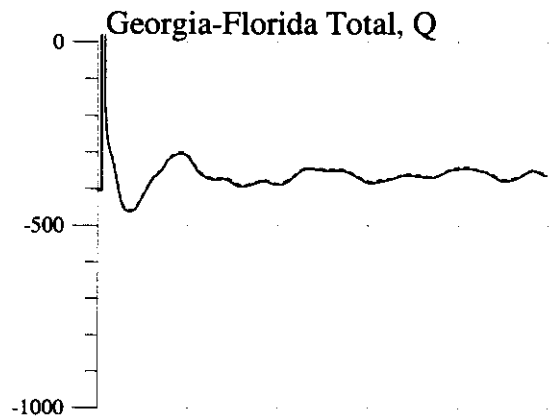
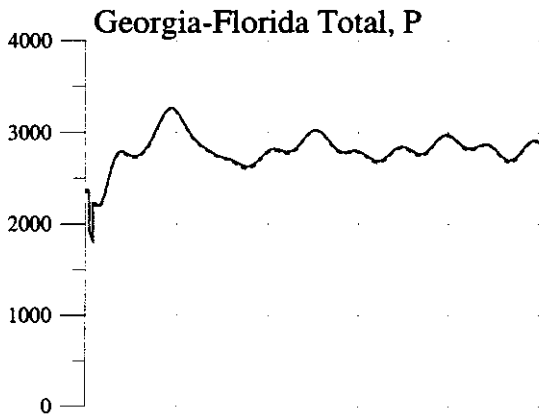

Time (Seconds)

Time (Seconds)



3-phase, 5-cycle Fault at Seminole 230kV Bus, Trip Seminole #1 & GSU
 2003 Summer System
 Machine Variables: (___) With Okeechobee So. FPL Dispatch, (...) Without

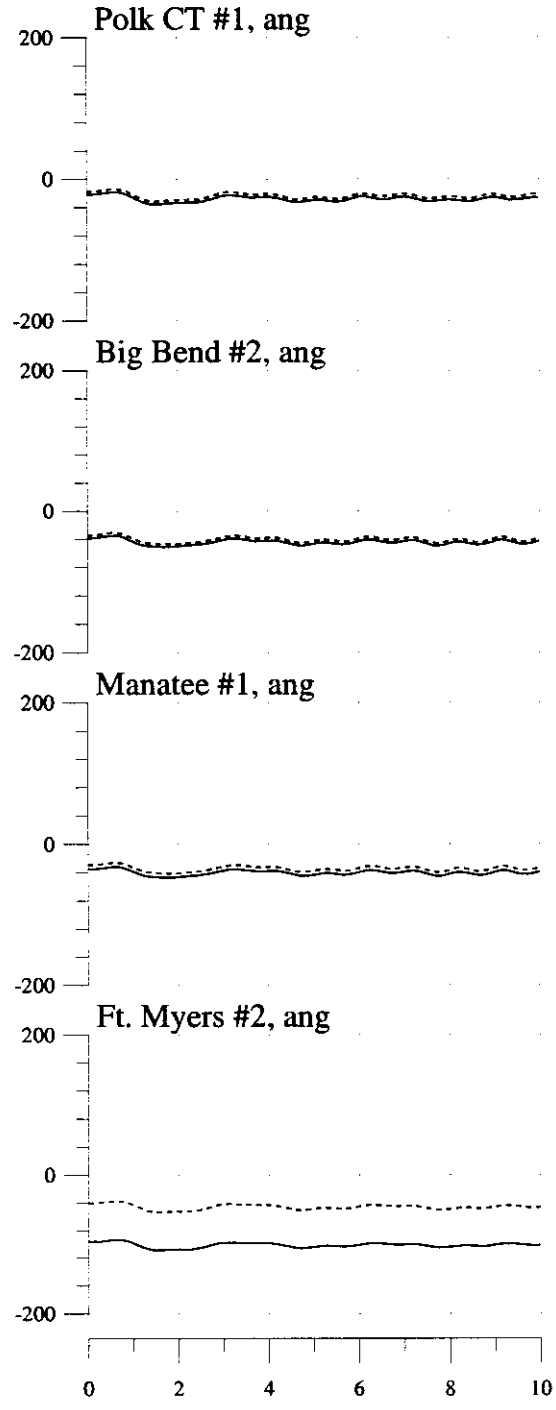
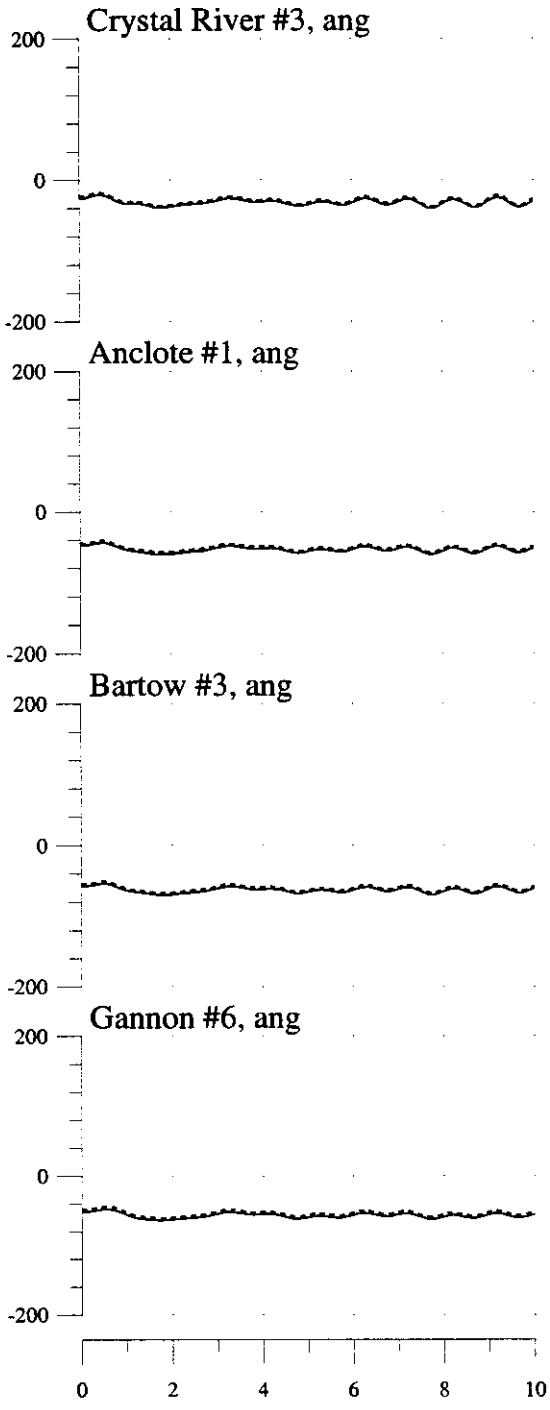

3-phase, 5-cycle Fault at Seminole 230kV Bus, Trip Seminole #1 & GSU
 2003 Summer System

Machine Variables: (___) With Okeechobee So. FPL Dispatch, (...) Without

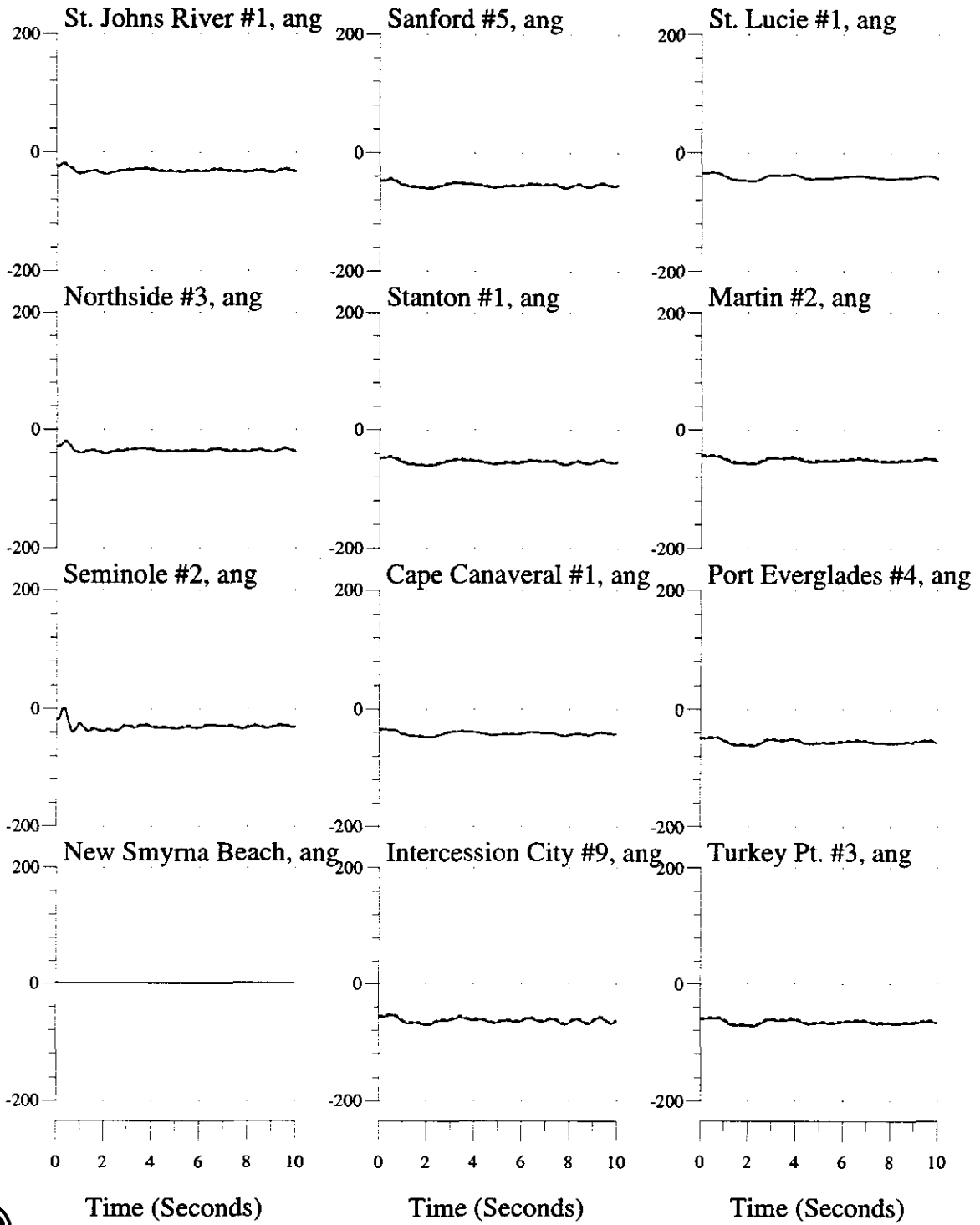

3-phase, 5-cycle Fault at Seminole 230kV Bus, Trip Seminole #1 & GSU
2003 Summer System

Bus Variables: (___) With Okeechobee So. FPL Dispatch, (...) Without

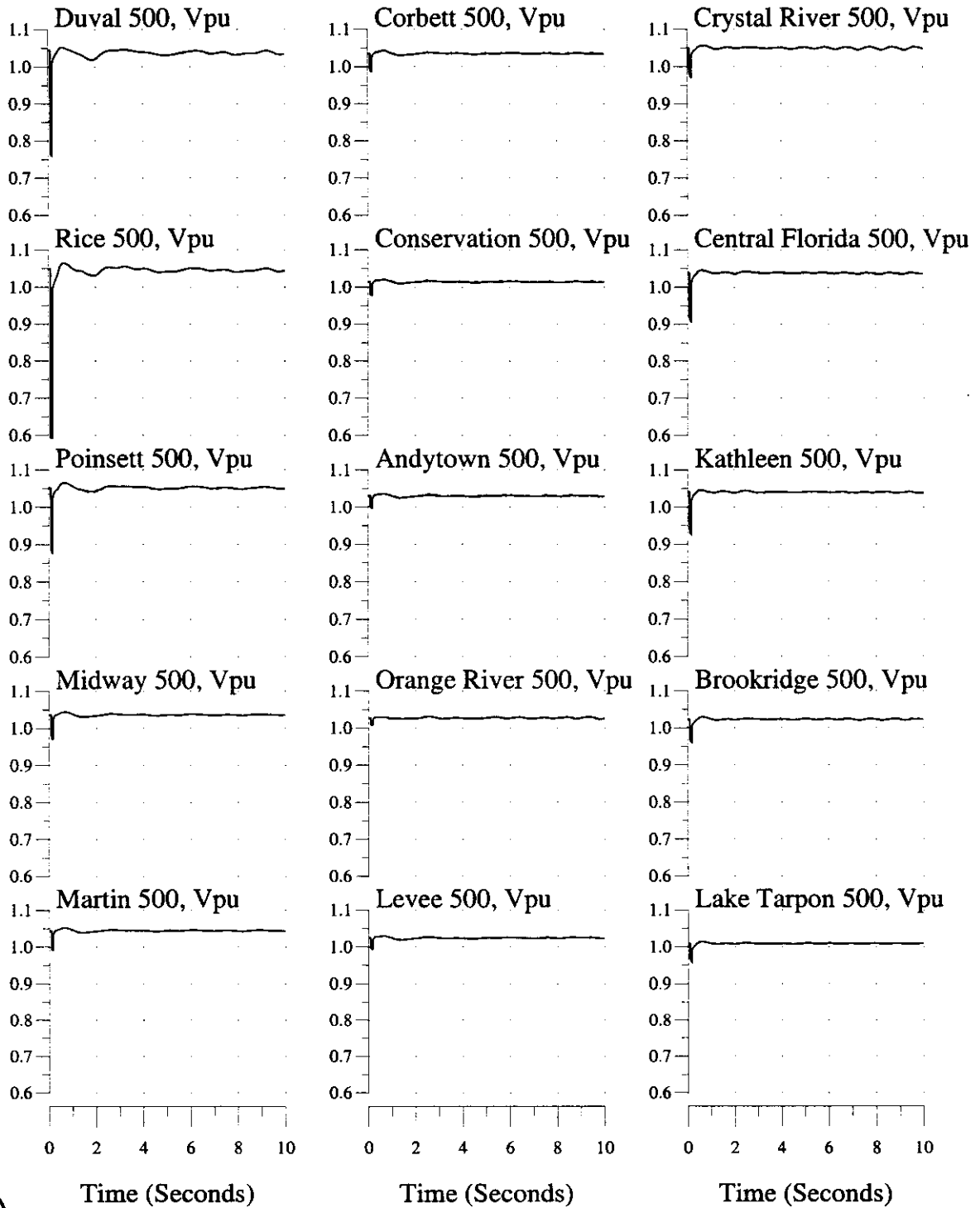

3-phase, 5-cycle Fault at Seminole 230kV Bus, Trip Seminole #1 & GSU
2003 Summer System

Bus Variables: (___) With Okeechobee So. FPL Dispatch, (...) Without

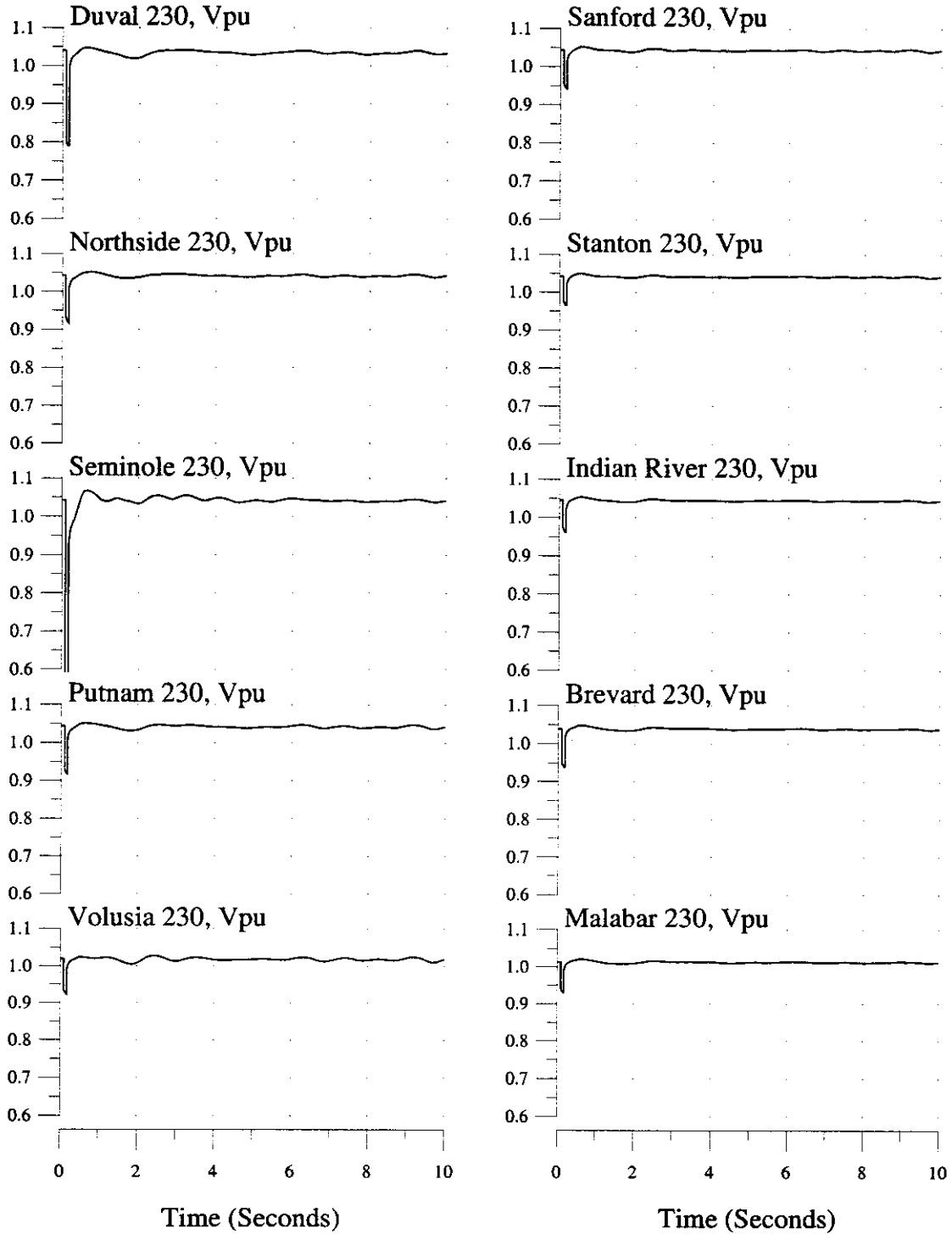

3-phase, 5-cycle Fault at Seminole 230kV Bus, Trip Seminole #1 & GSU
2003 Summer System

Bus Variables: (___) With Okeechobee So. FPL Dispatch, (...) Without

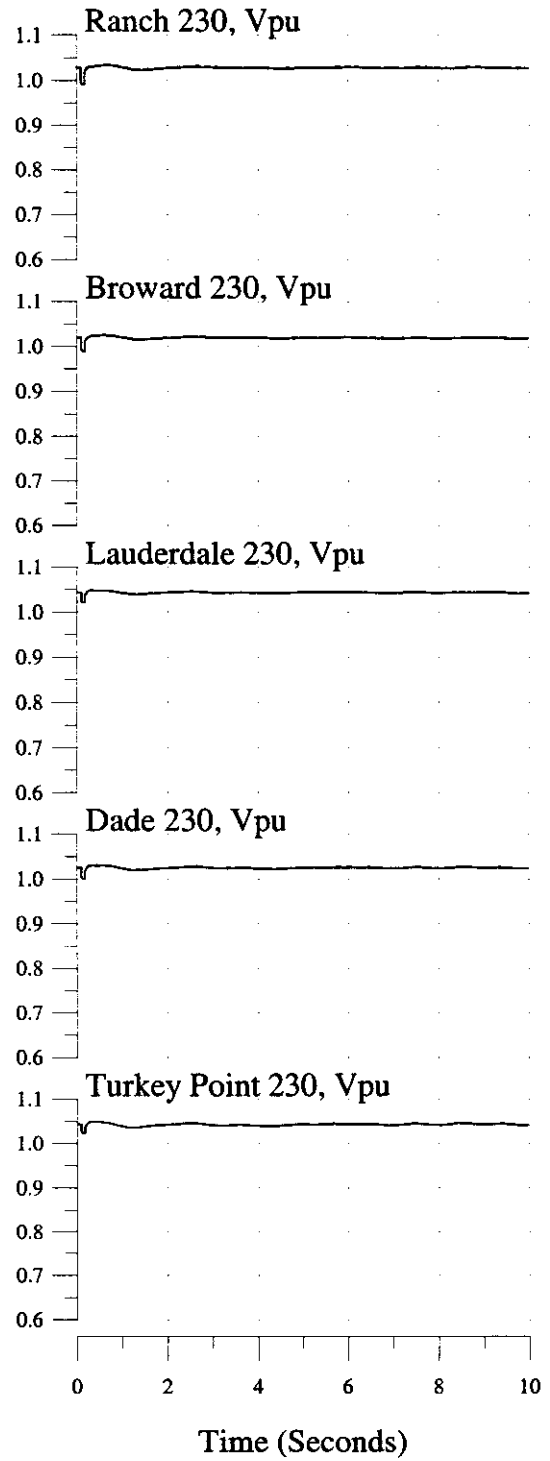
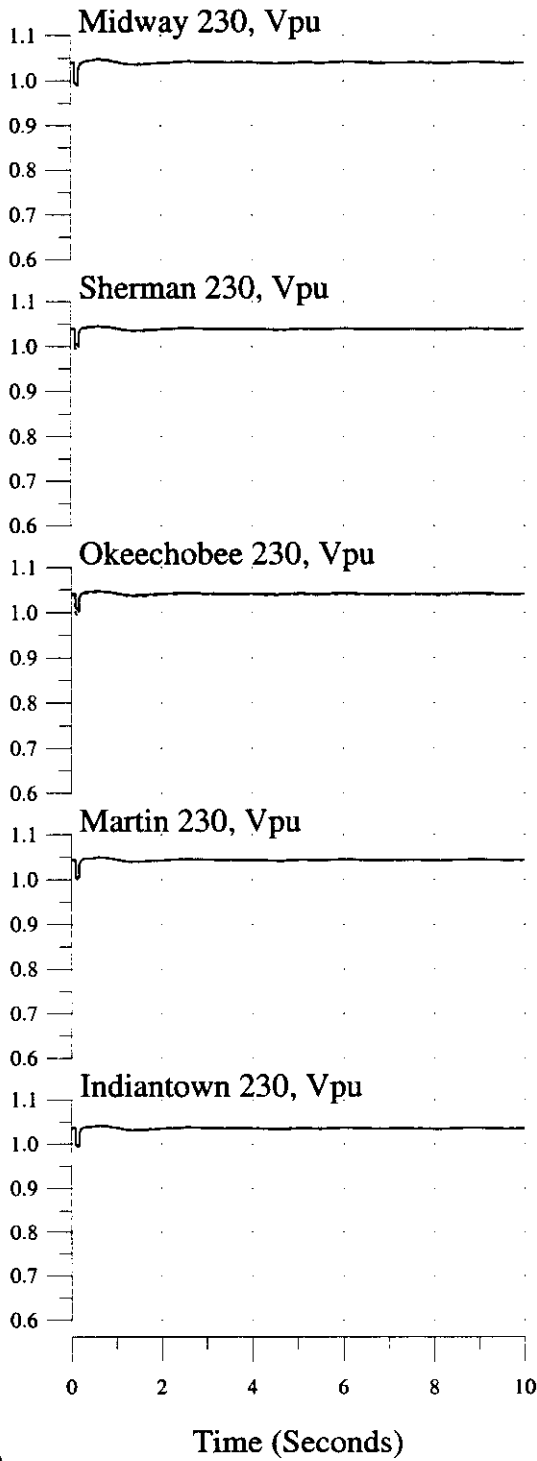

3-phase, 5-cycle Fault at Seminole 230kV Bus, Trip Seminole #1 & GSU
 2003 Summer System

Bus Variables: (___) With Okeechobee So. FPL Dispatch, (...) Without

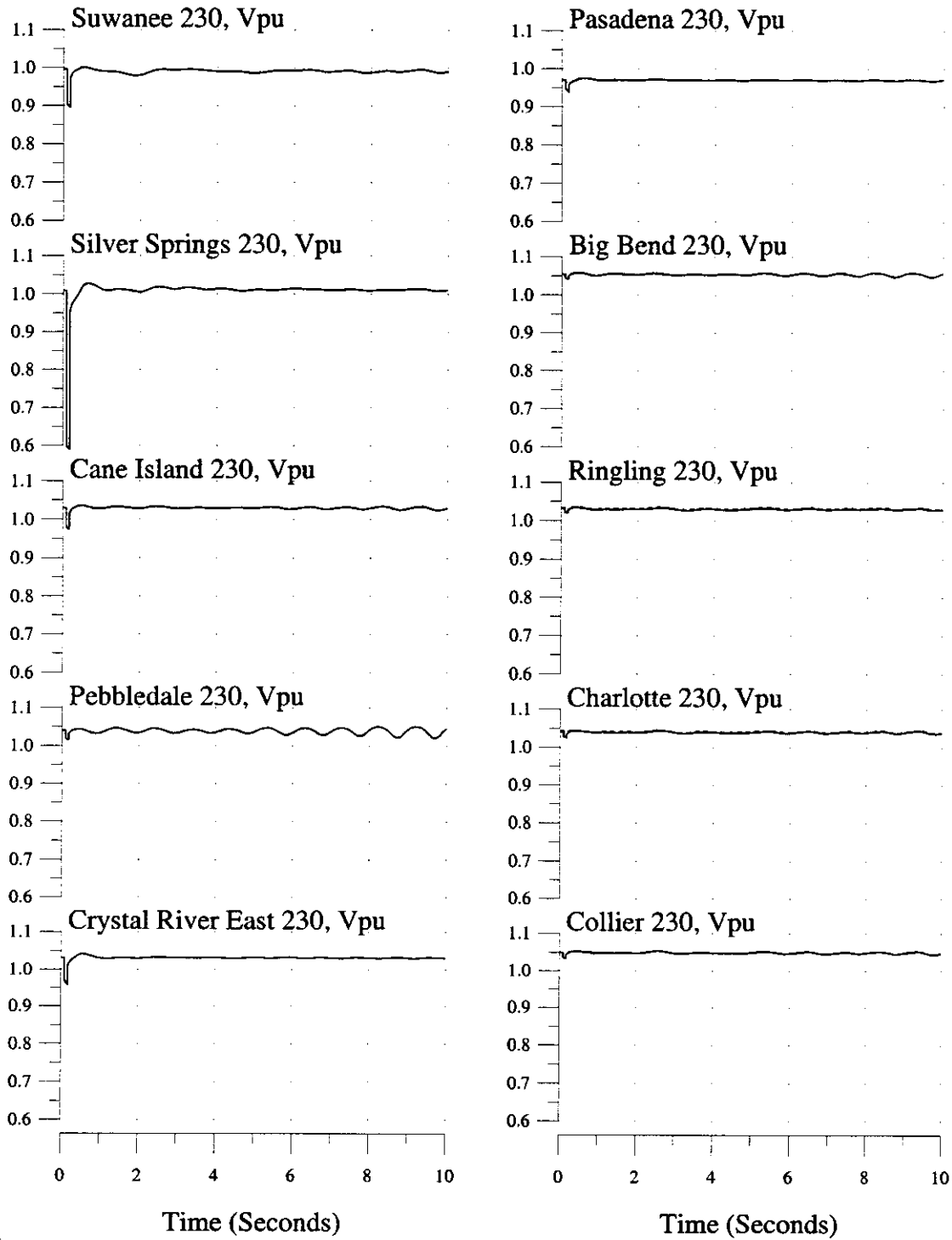

3-phase, 5-cycle Fault at Martin 500kV Bus, Trip Martin #2 & GSU
2003 Summer System

Machine & Interface Variables: (___) With Okeechobee So. FPL Dispatch, (...) Without

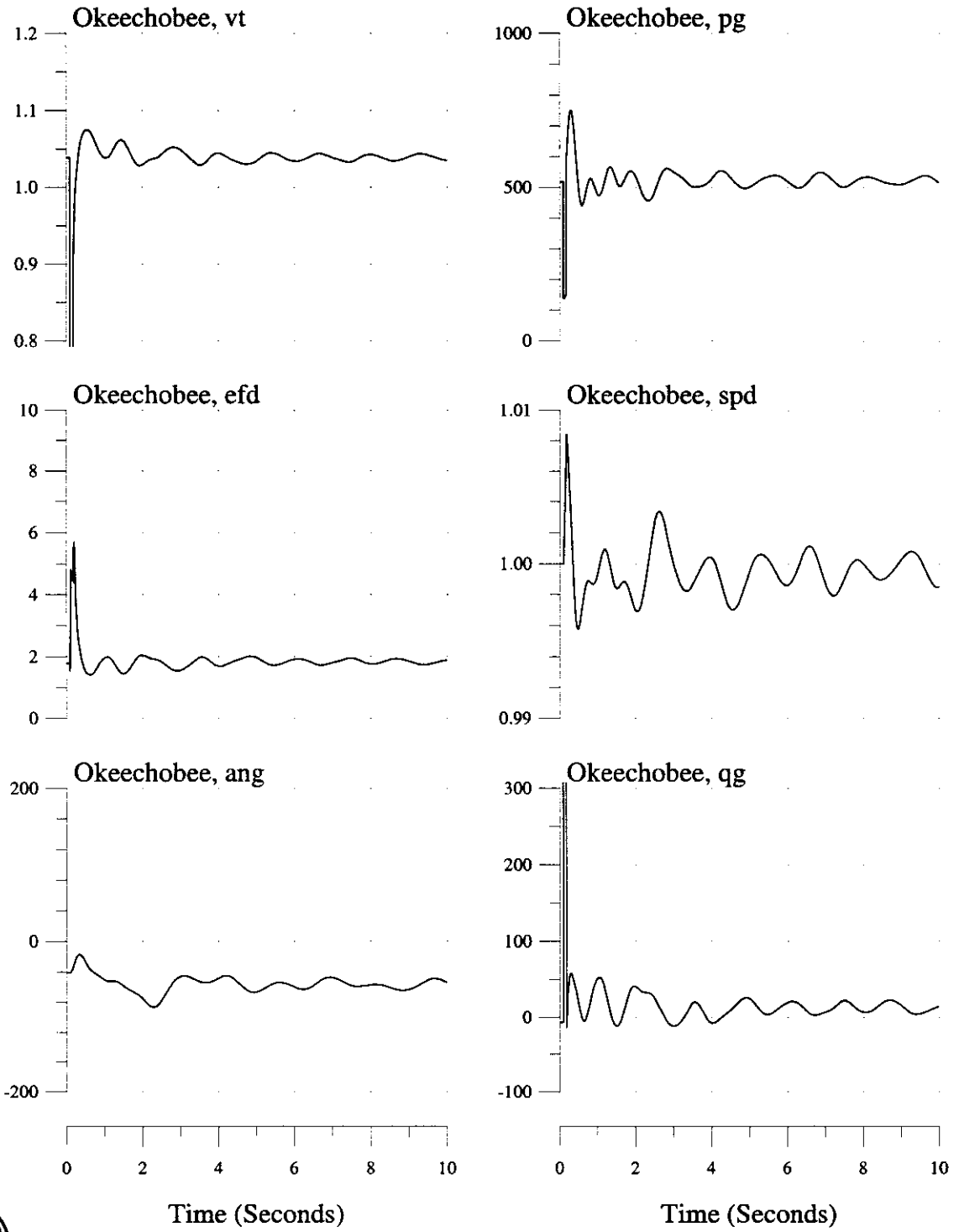

3-phase, 5-cycle Fault at Martin 500kV Bus, Trip Martin #2 & GSU
2003 Summer System

Machine & Interface Variables: (—) With Okeechobee So. FPL Dispatch, (...) Without

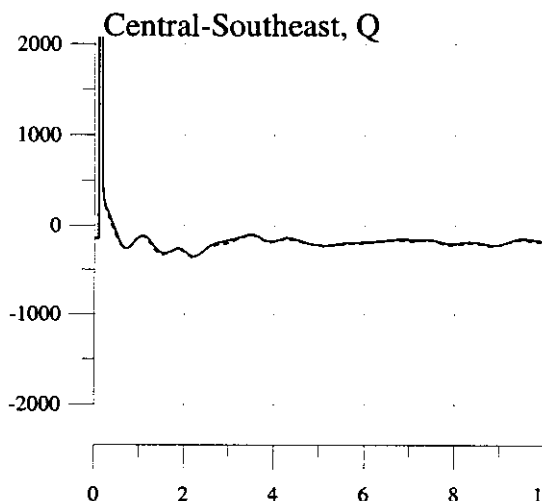
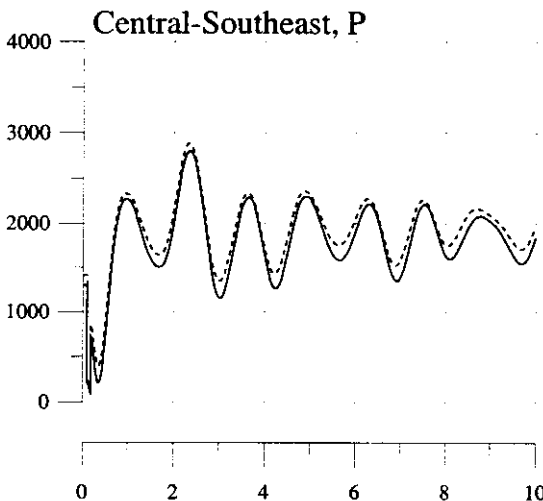
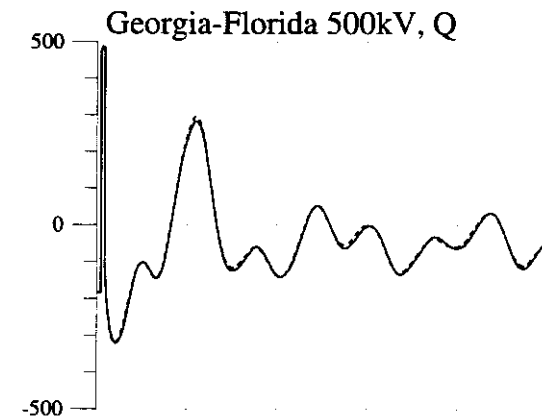
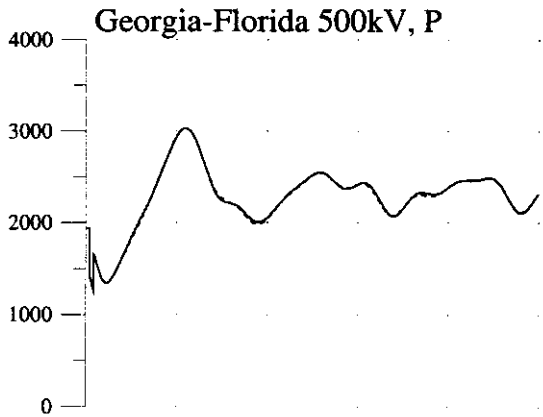
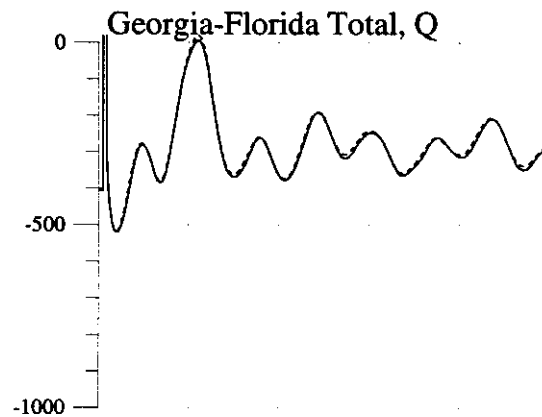
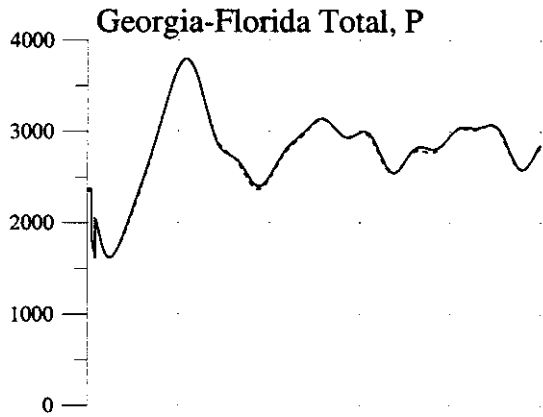

Time (Seconds)

Time (Seconds)



3-phase, 5-cycle Fault at Martin 500kV Bus, Trip Martin #2 & GSU
2003 Summer System

Machine Variables: (—) With Okeechobee So. FPL Dispatch, (...) Without

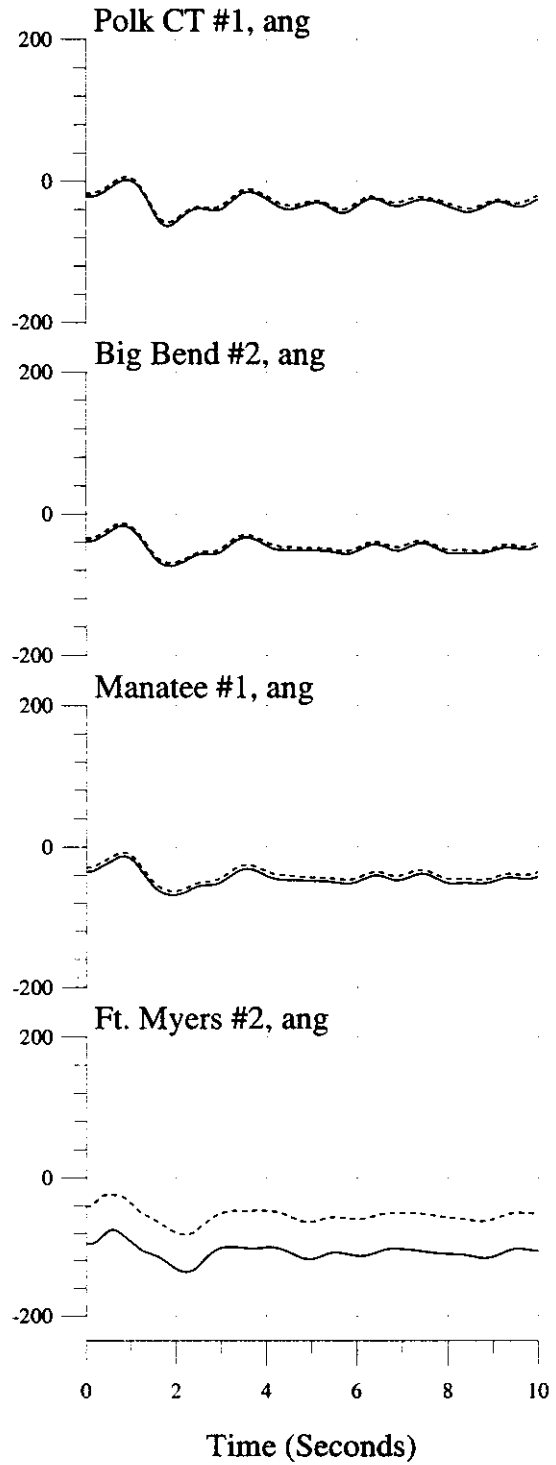
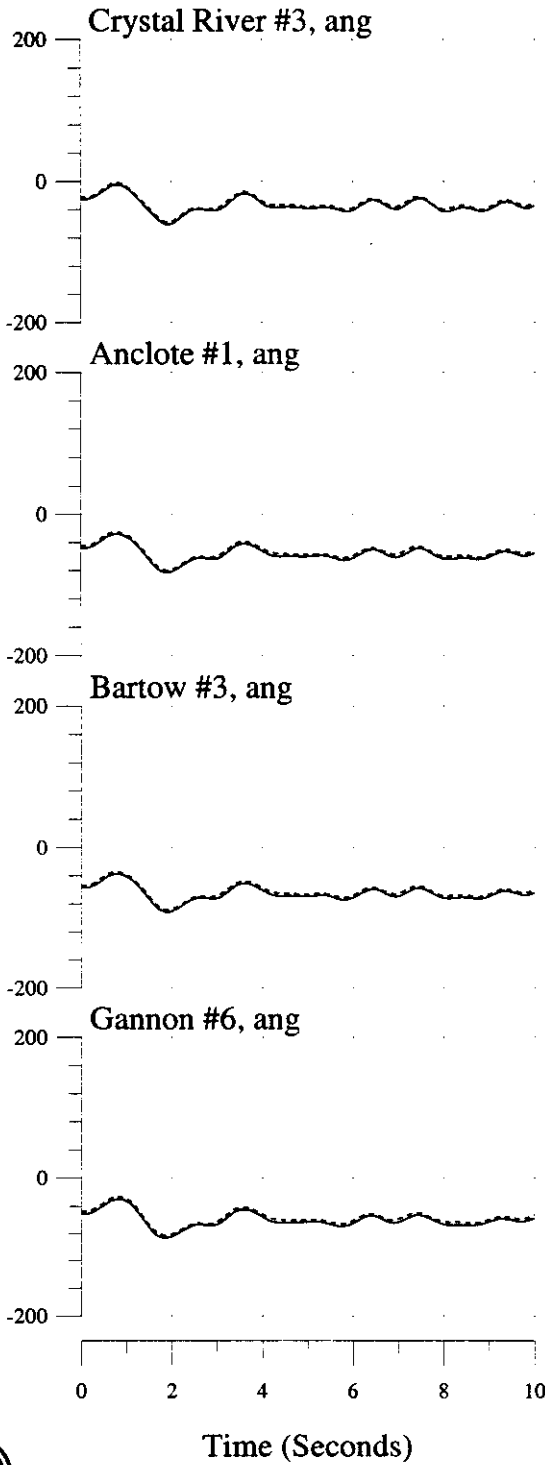

3-phase, 5-cycle Fault at Martin 500kV Bus, Trip Martin #2 & GSU
 2003 Summer System

Machine Variables: (___) With Okeechobee So. FPL Dispatch, (...) Without

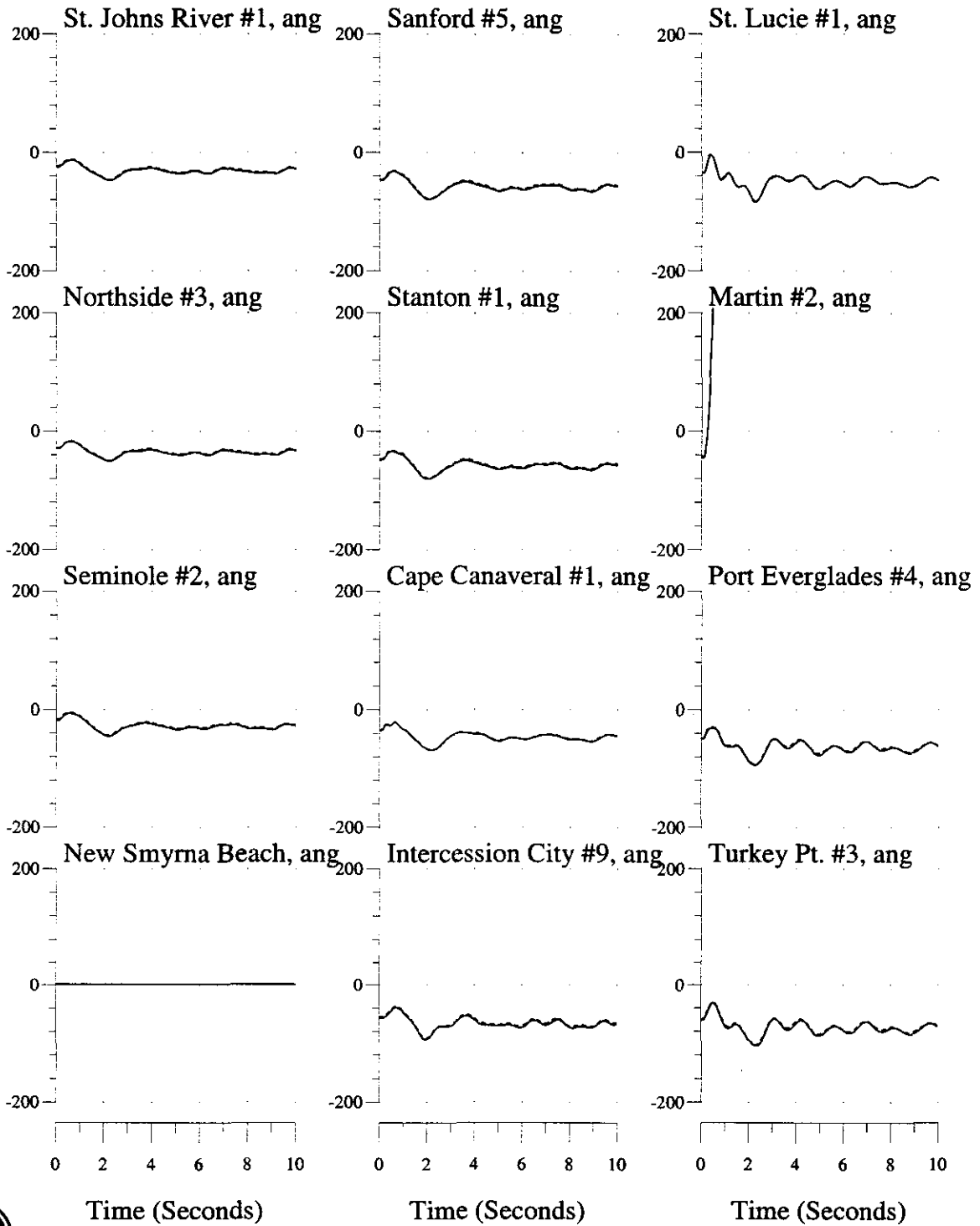

3-phase, 5-cycle Fault at Martin 500kV Bus, Trip Martin #2 & GSU
 2003 Summer System

Bus Variables: (—) With Okeechobee So. FPL Dispatch, (...) Without

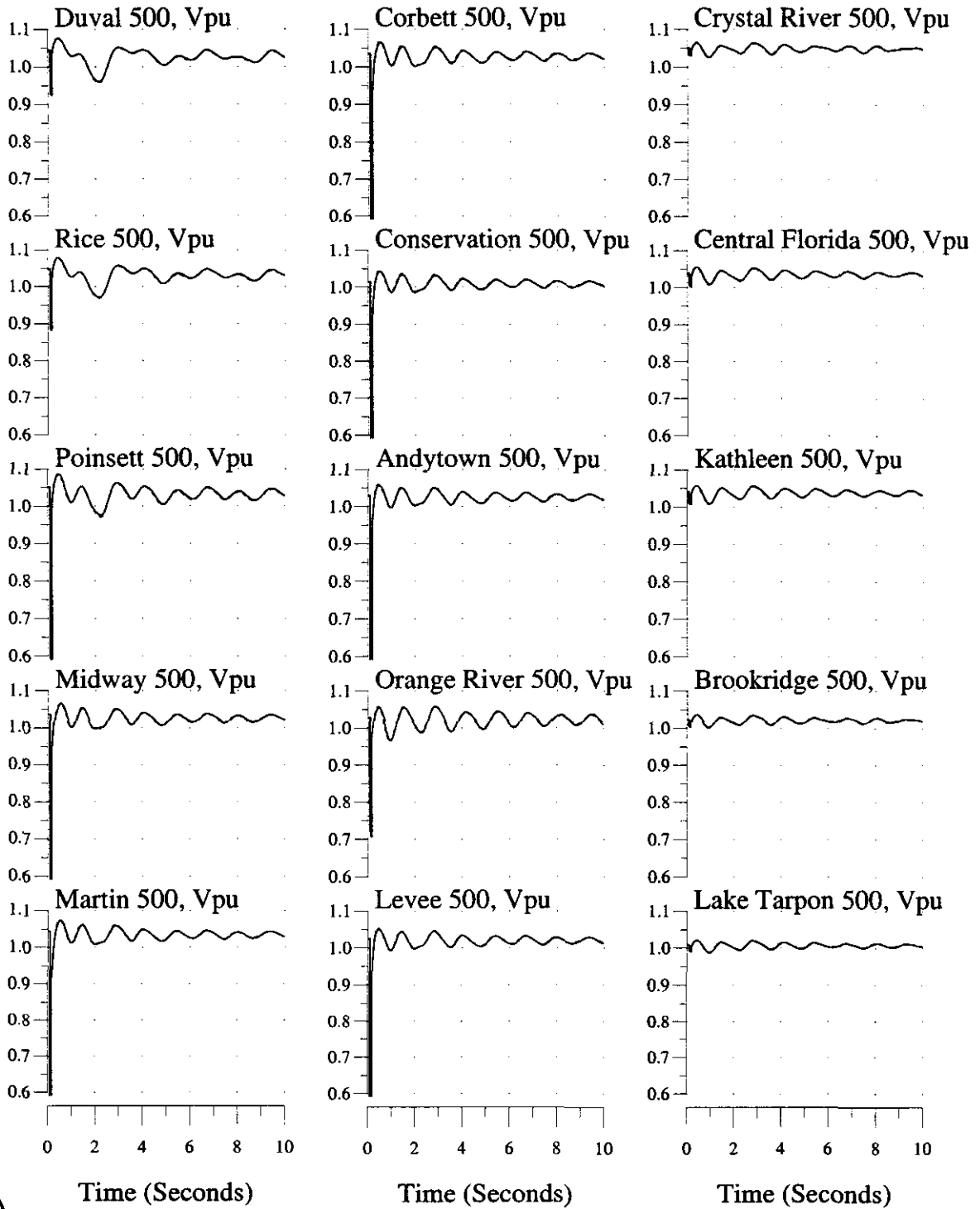

3-phase, 5-cycle Fault at Martin 500kV Bus, Trip Martin #2 & GSU
2003 Summer System

Bus Variables: (___) With Okeechobee So. FPL Dispatch, (...) Without

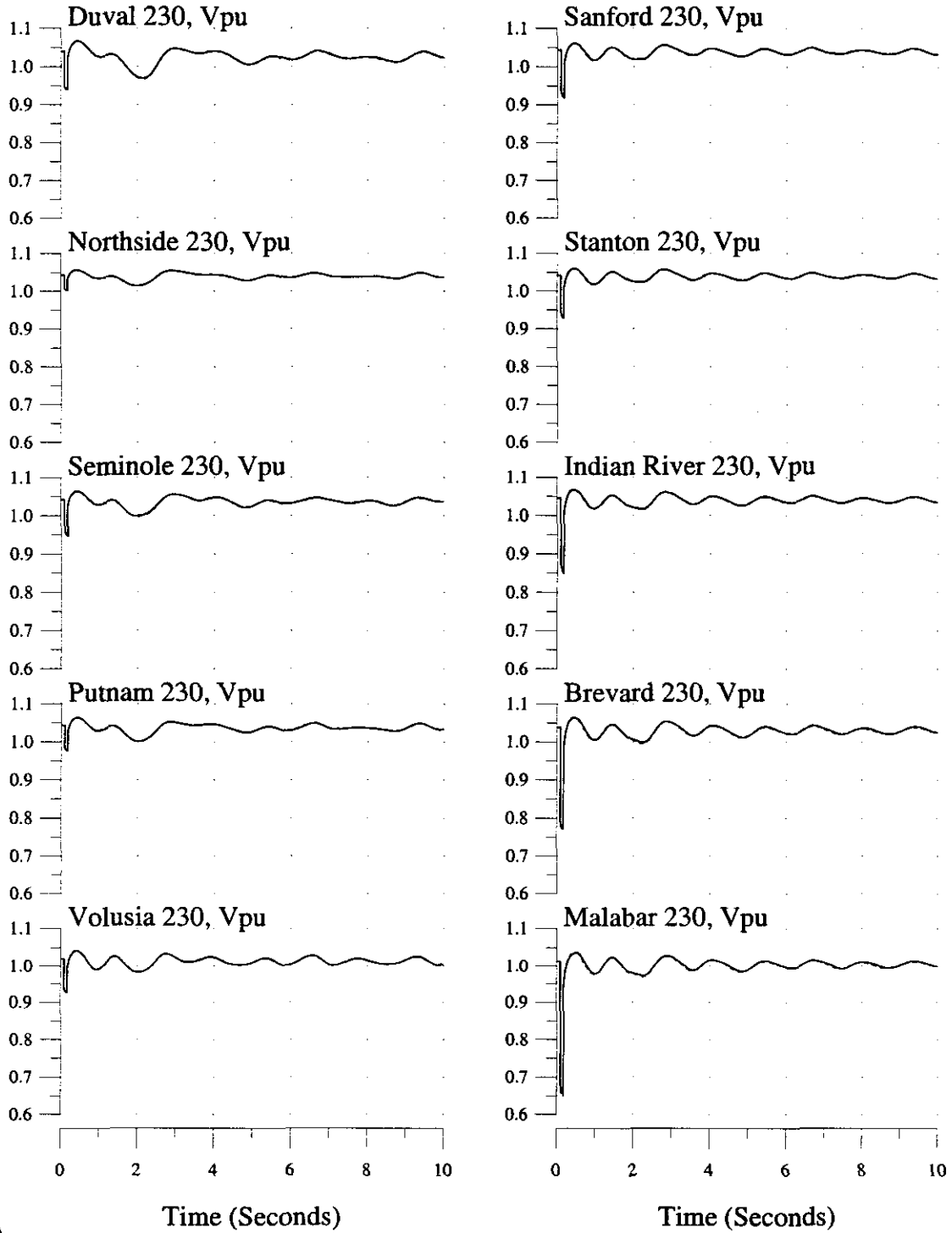

3-phase, 5-cycle Fault at Martin 500kV Bus, Trip Martin #2 & GSU
2003 Summer System

Bus Variables: (—) With Okeechobee So. FPL Dispatch, (...) Without

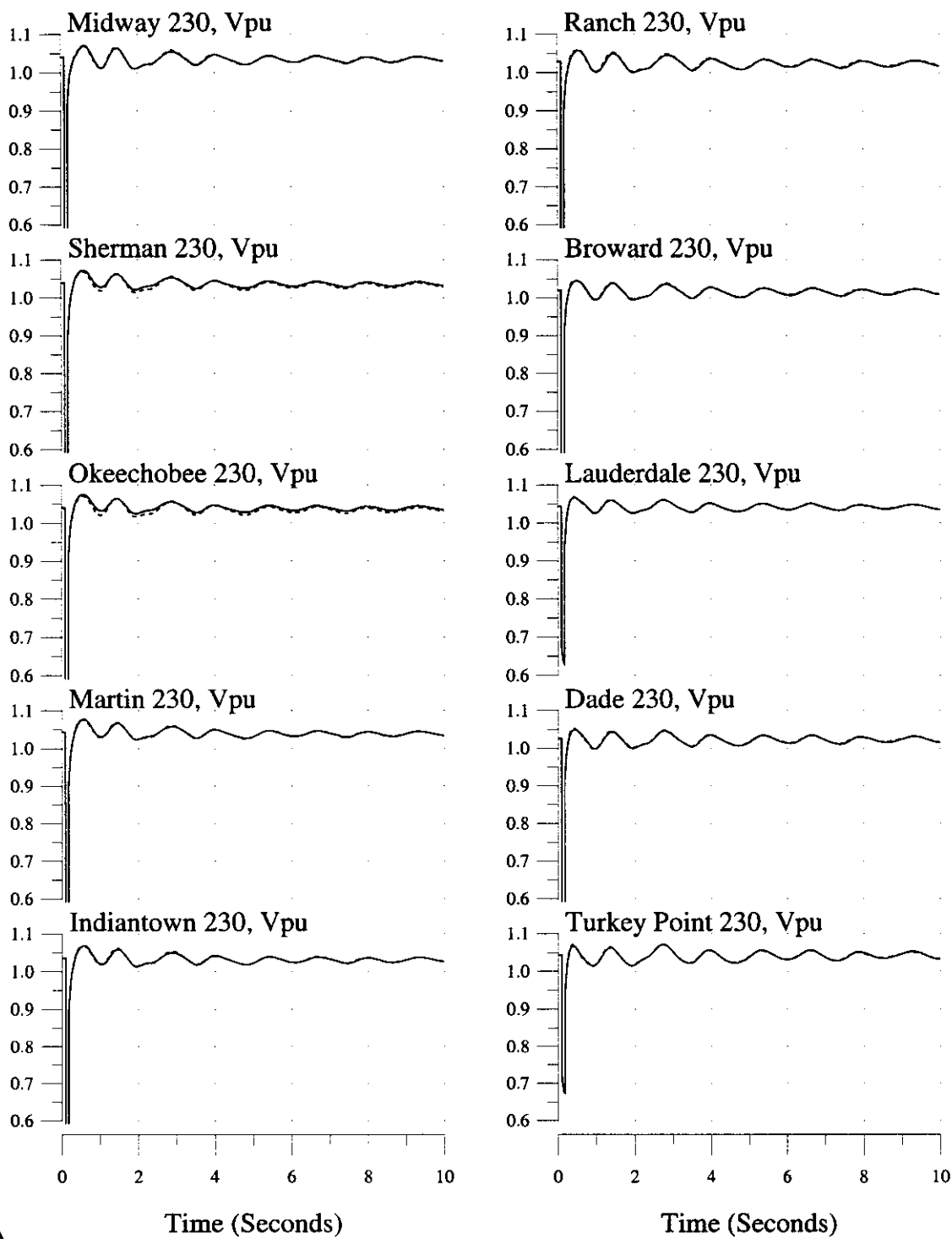

3-phase, 5-cycle Fault at Martin 500kV Bus, Trip Martin #2 & GSU
 2003 Summer System

Bus Variables: (___) With Okeechobee So. FPL Dispatch, (...) Without

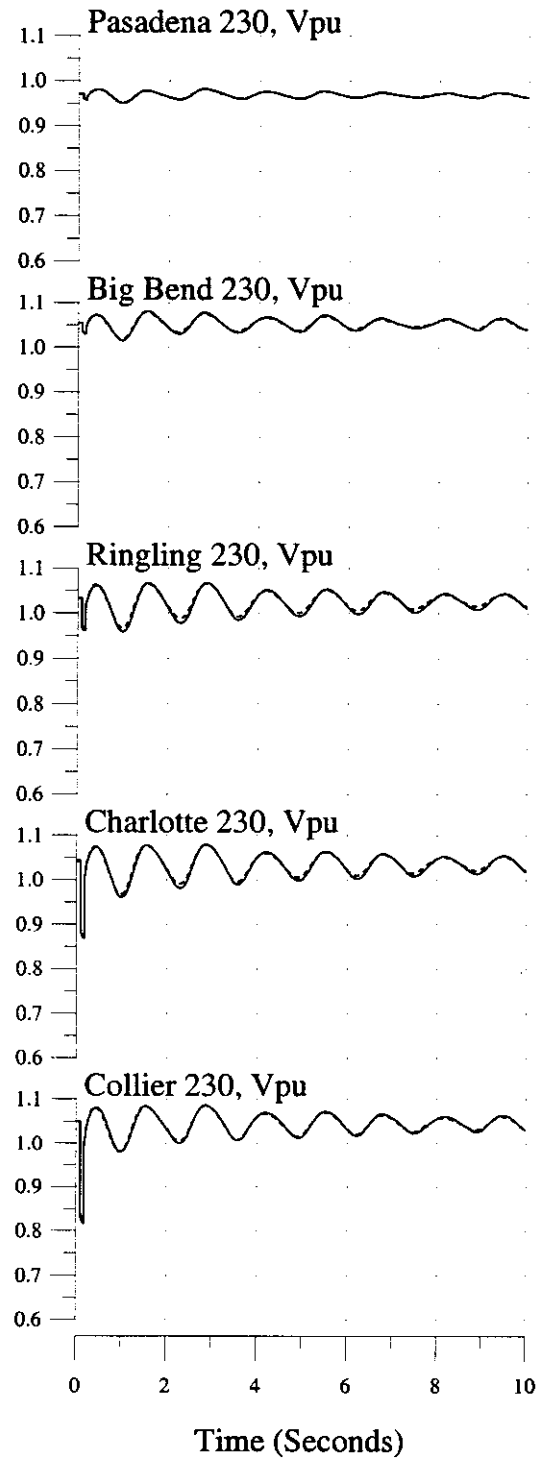
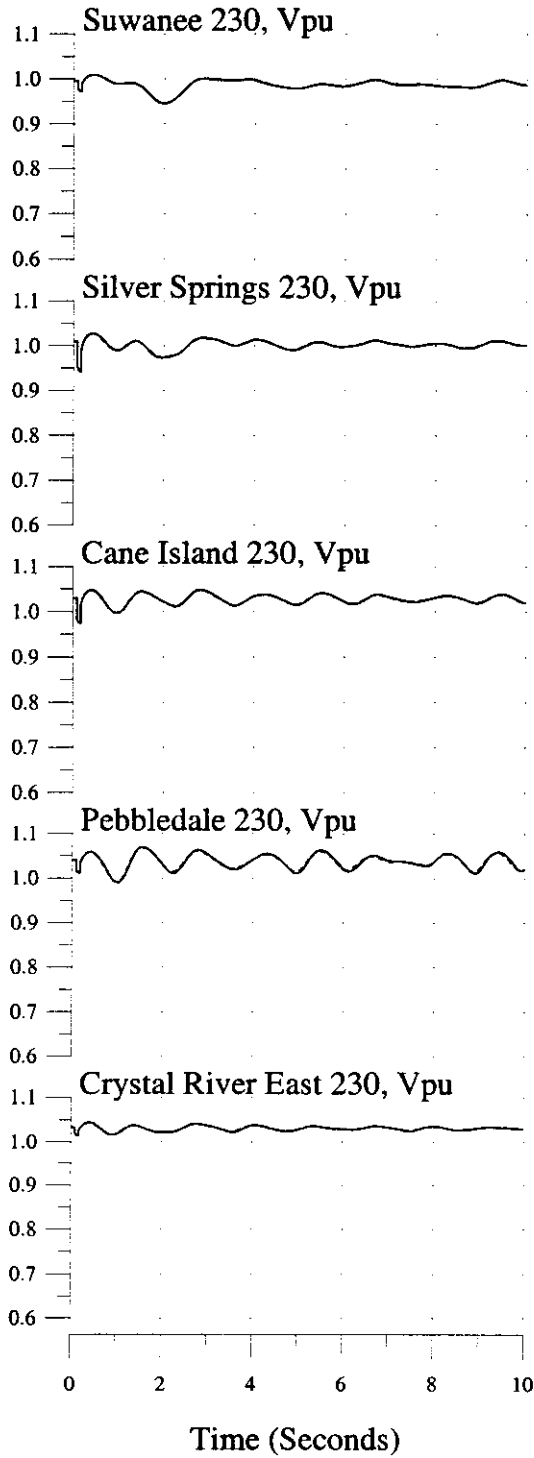

3-phase, 5-cycle Fault at Duval 500kV Bus, Trip Thalmann-Duval 500kV Line
2003 Summer System

Machine & Interface Variables: (___) With Okeechobee So. FPL Dispatch, (...) Without

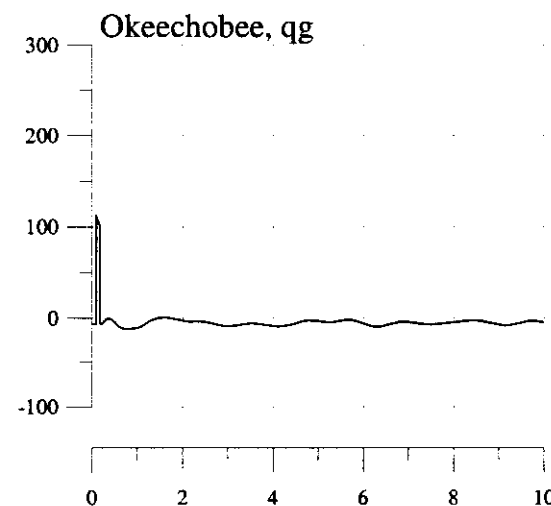
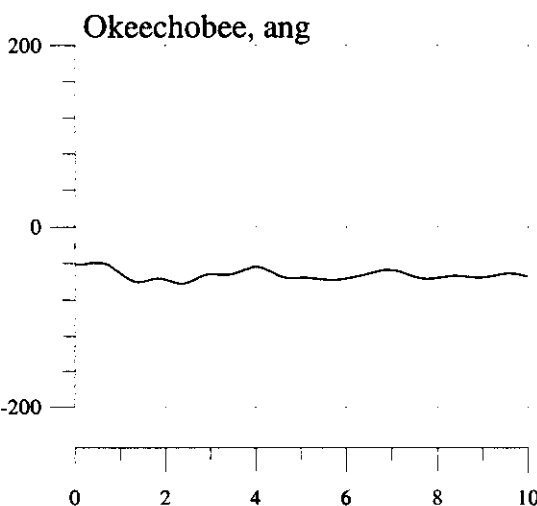
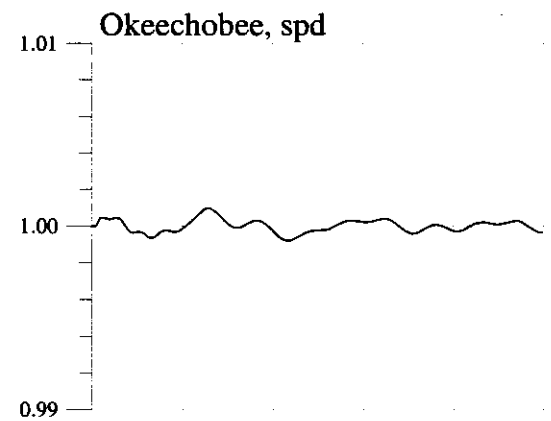
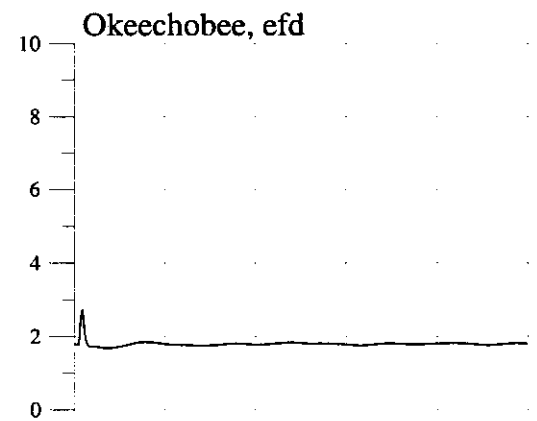
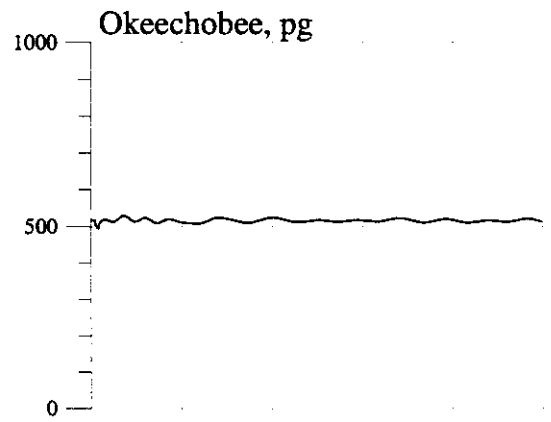
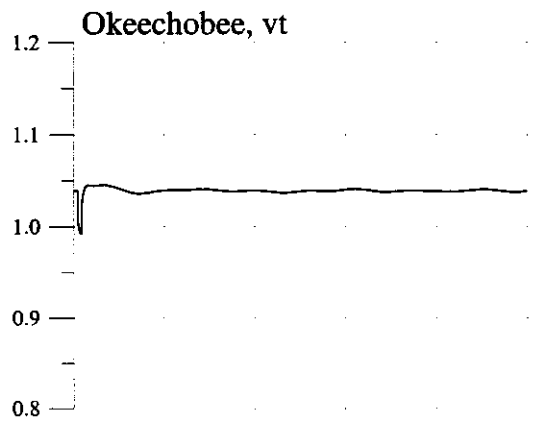

Time (Seconds)

Time (Seconds)



3-phase, 5-cycle Fault at Duval 500kV Bus, Trip Thalmann-Duval 500kV Line
2003 Summer System

Machine & Interface Variables: (—) With Okeechobee So. FPL Dispatch, (...) Without

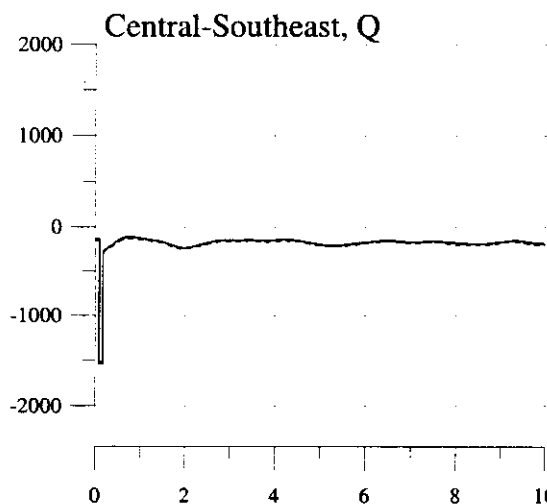
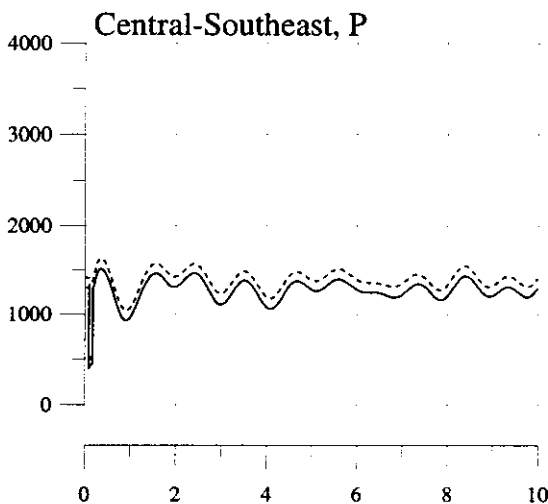
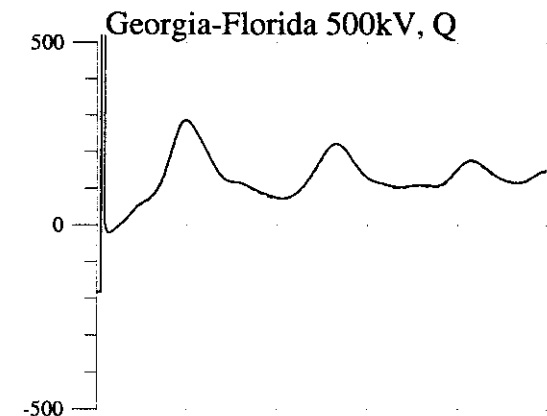
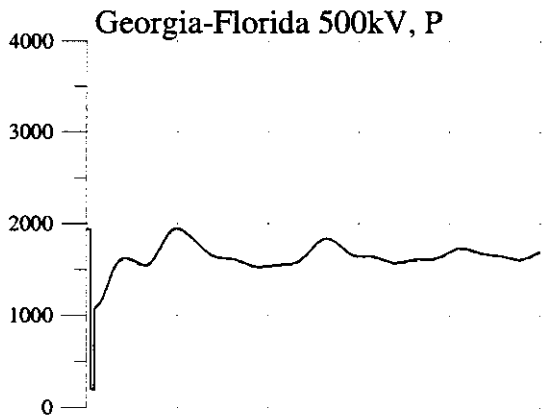
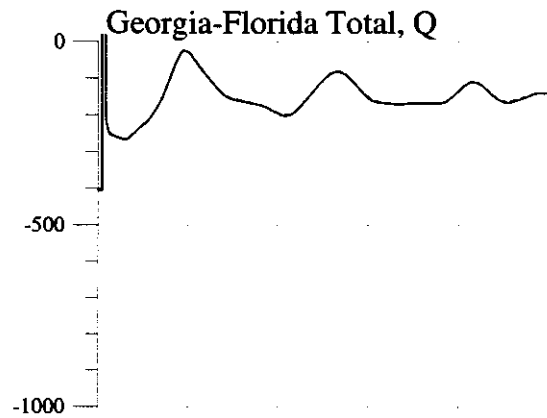
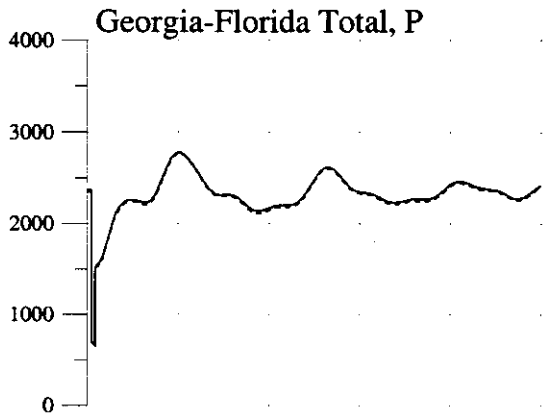

Time (Seconds)

Time (Seconds)



3-phase, 5-cycle Fault at Duval 500kV Bus, Trip Thalmann-Duval 500kV Line
2003 Summer System

Machine Variables: (—) With Okeechobee So. FPL Dispatch, (...) Without

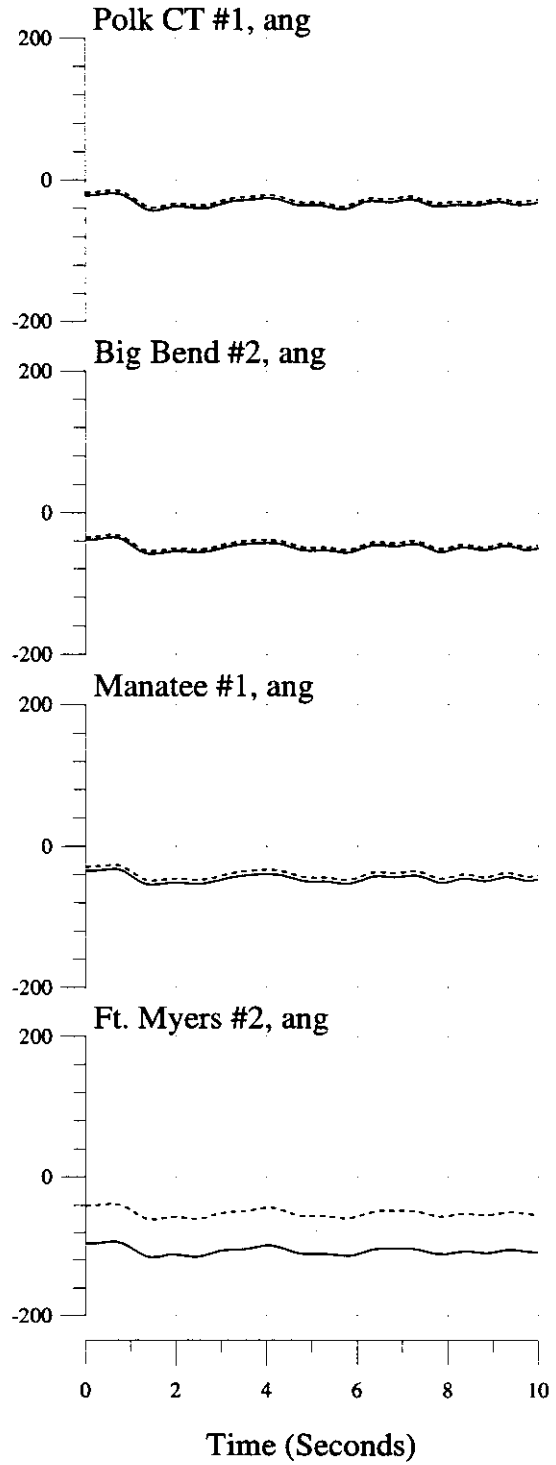
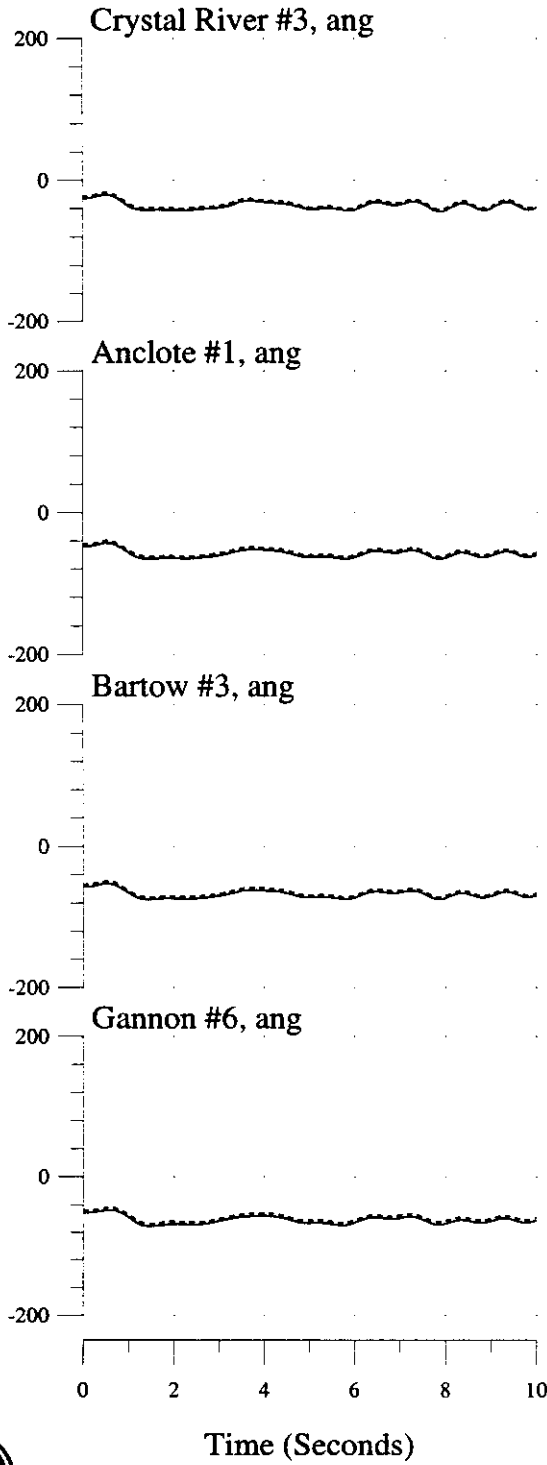

3-phase, 5-cycle Fault at Duval 500kV Bus, Trip Thalmann-Duval 500kV Line
2003 Summer System

Machine Variables: (—) With Okeechobee So. FPL Dispatch, (...) Without

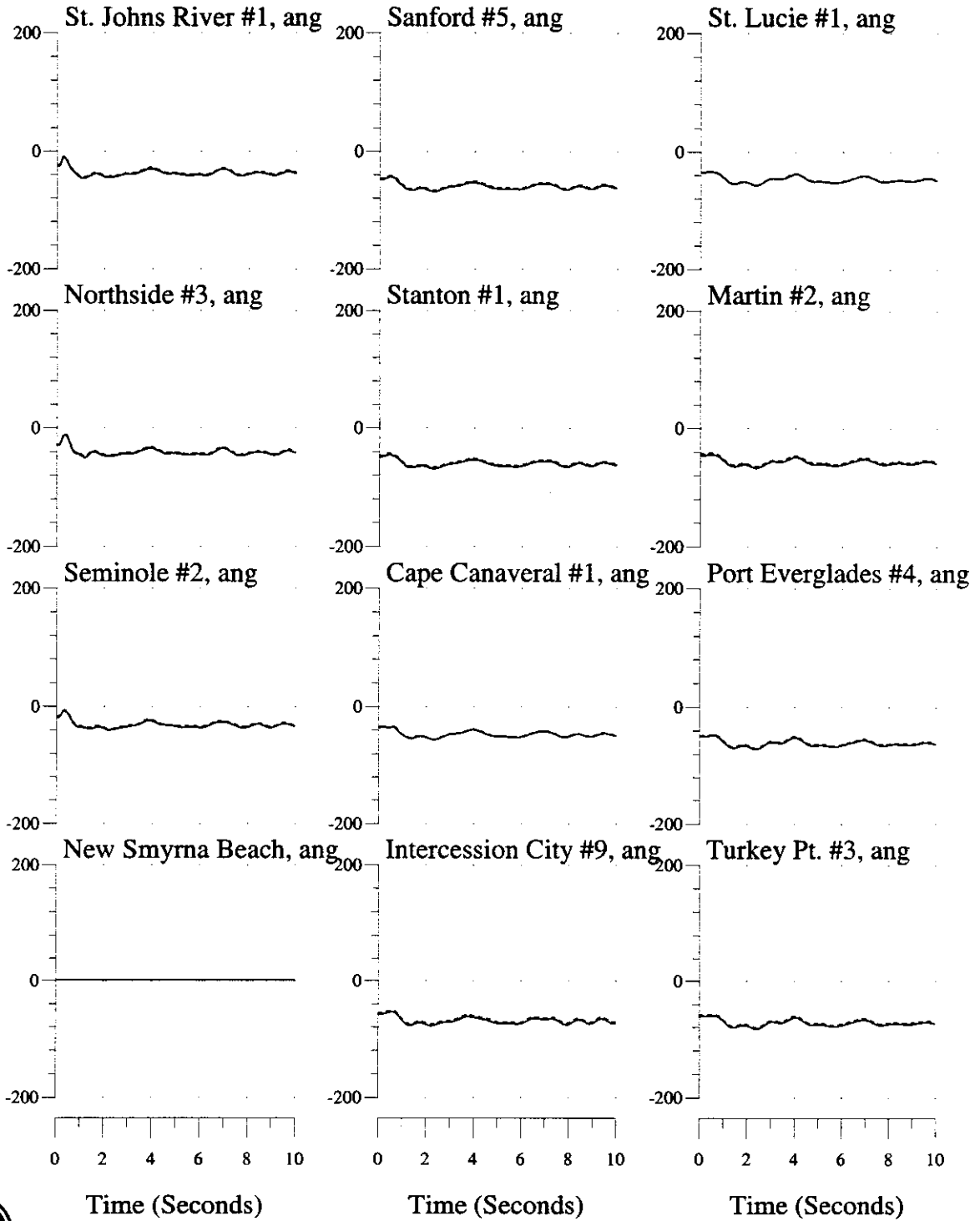

3-phase, 5-cycle Fault at Duval 500kV Bus, Trip Thalmann-Duval 500kV Line
 2003 Summer System

Bus Variables: (___) With Okeechobee So. FPL Dispatch, (...) Without

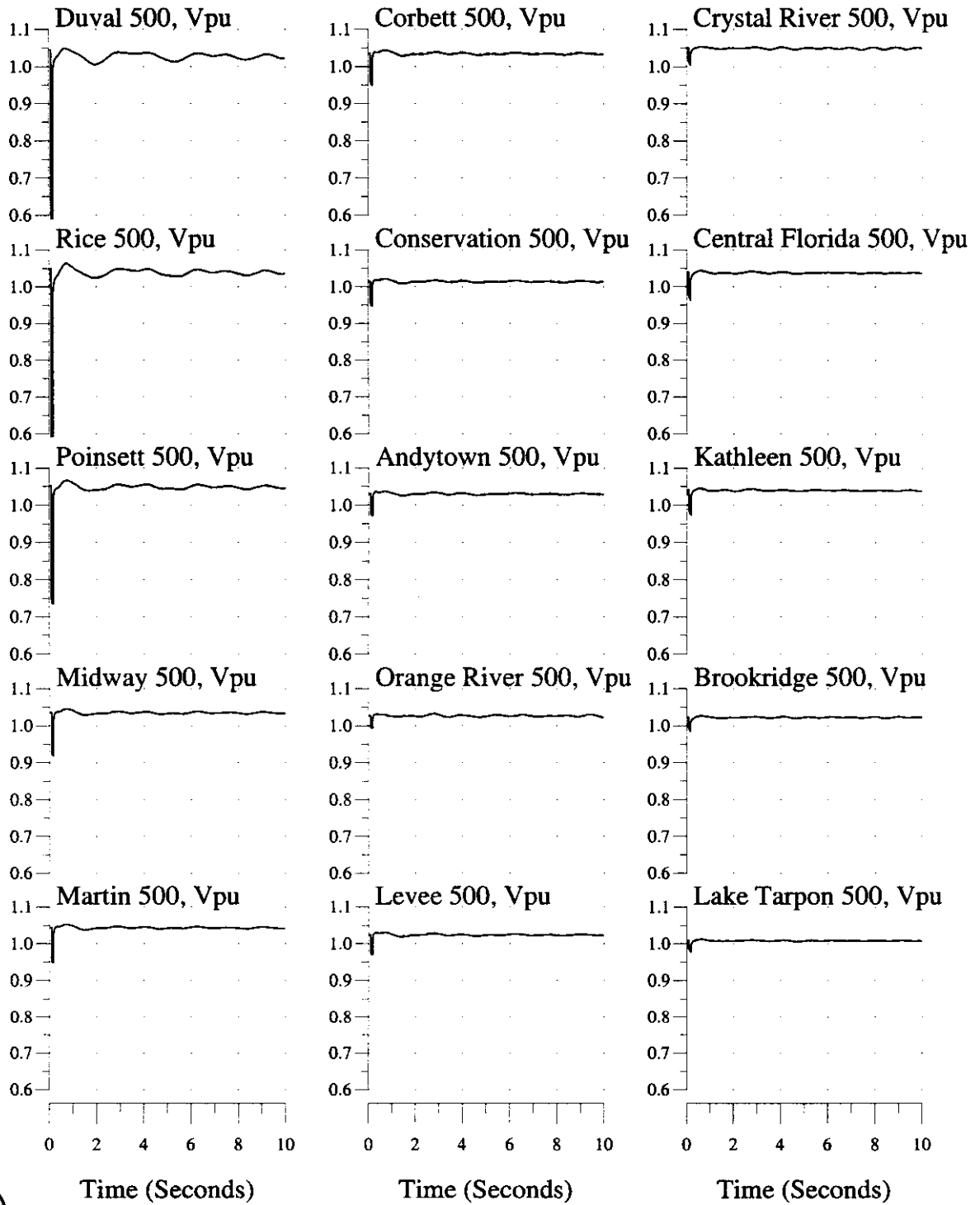

3-phase, 5-cycle Fault at Duval 500kV Bus, Trip Thalmann-Duval 500kV Line
2003 Summer System

Bus Variables: (___) With Okeechobee So. FPL Dispatch, (...) Without

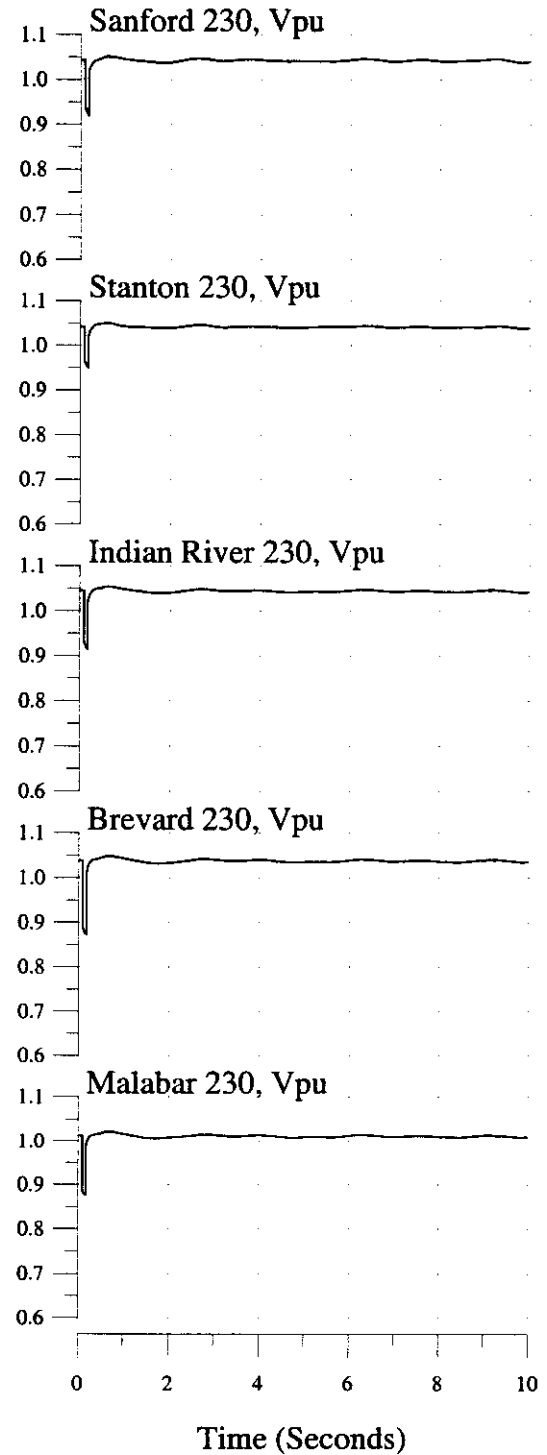
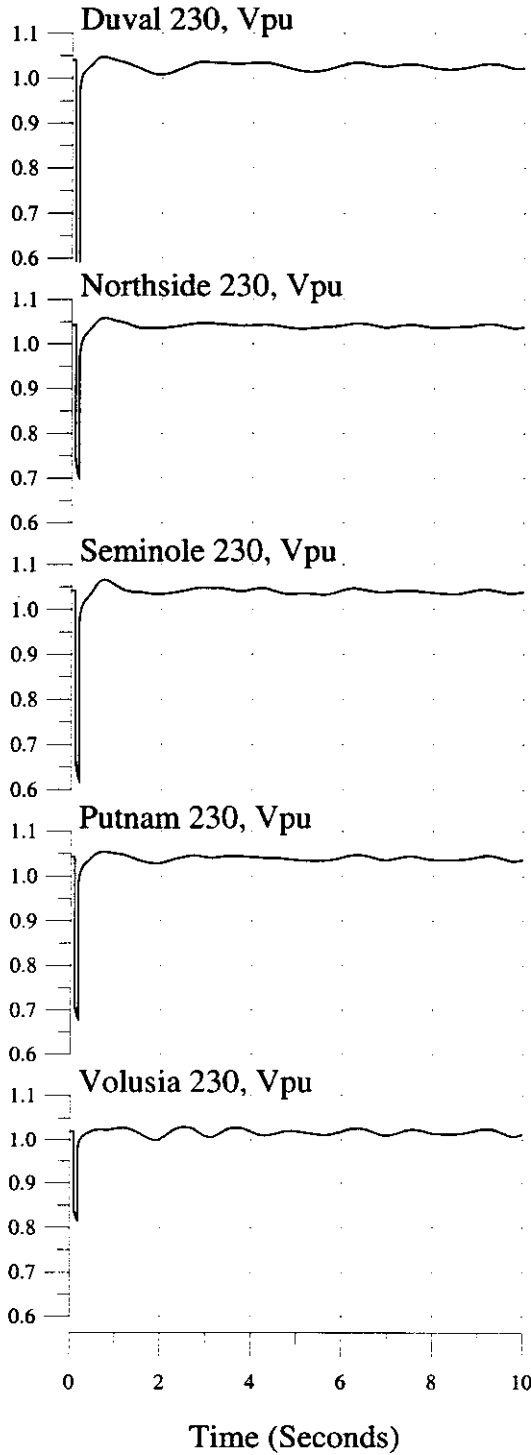

3-phase, 5-cycle Fault at Duval 500kV Bus, Trip Thalmann-Duval 500kV Line
2003 Summer System

Bus Variables: (___) With Okeechobee So. FPL Dispatch, (...) Without

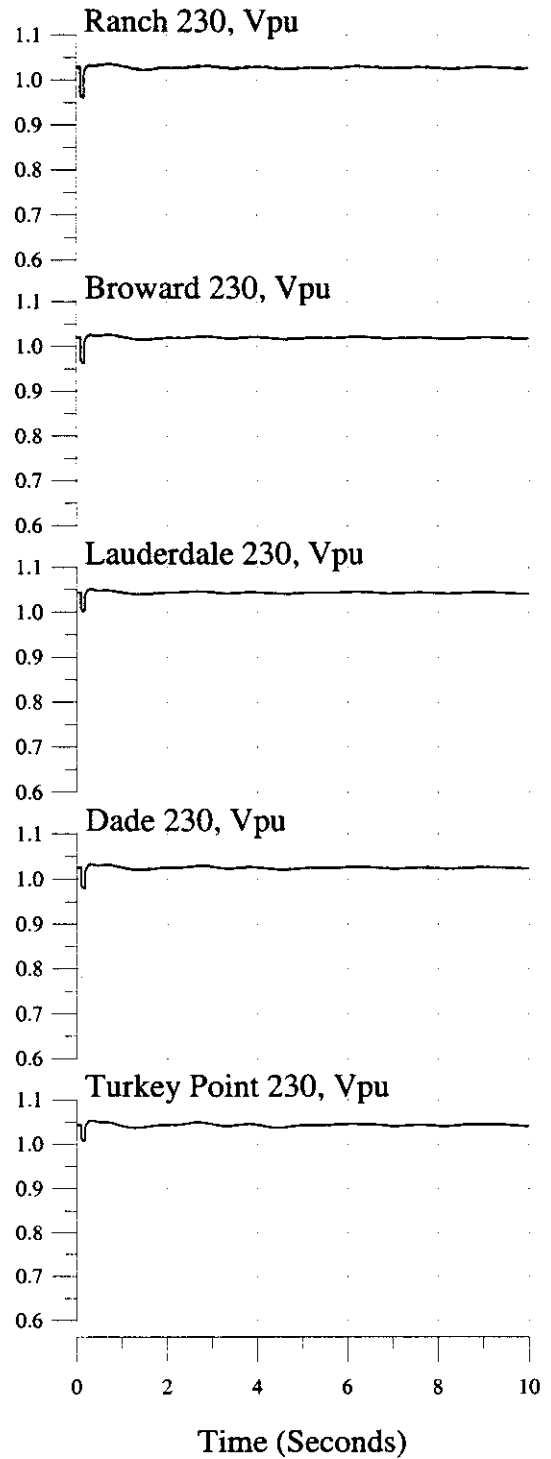
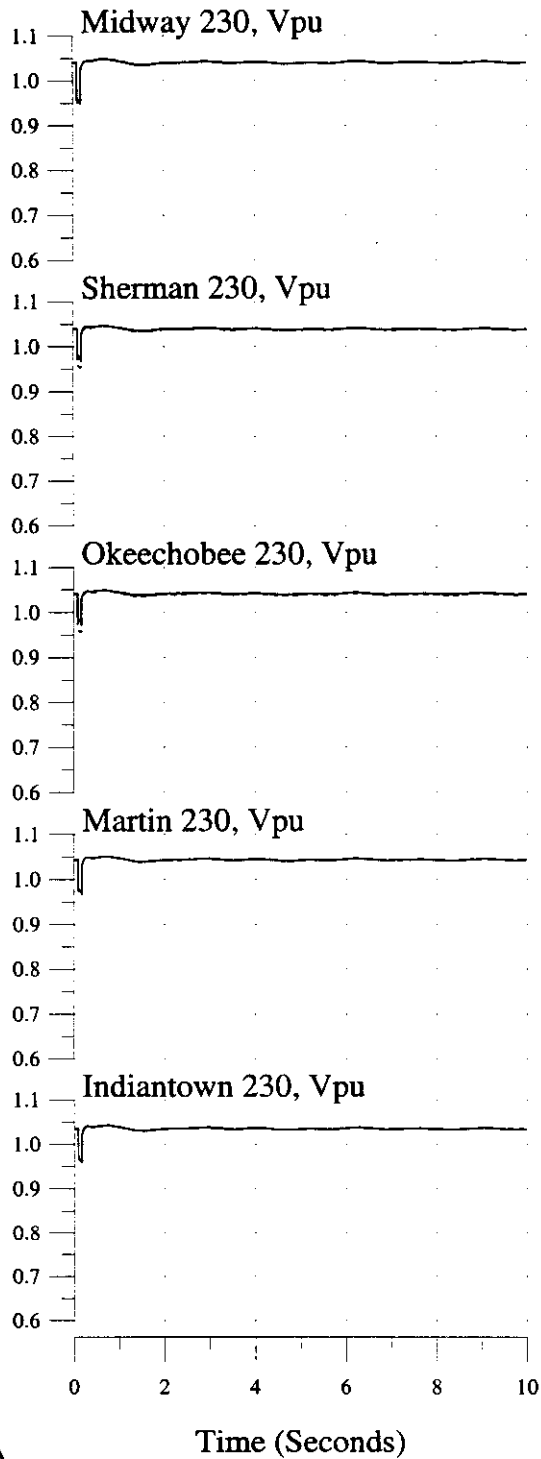

3-phase, 5-cycle Fault at Duval 500kV Bus, Trip Thalmann-Duval 500kV Line
 2003 Summer System

Bus Variables: (___) With Okeechobee So. FPL Dispatch, (...) Without

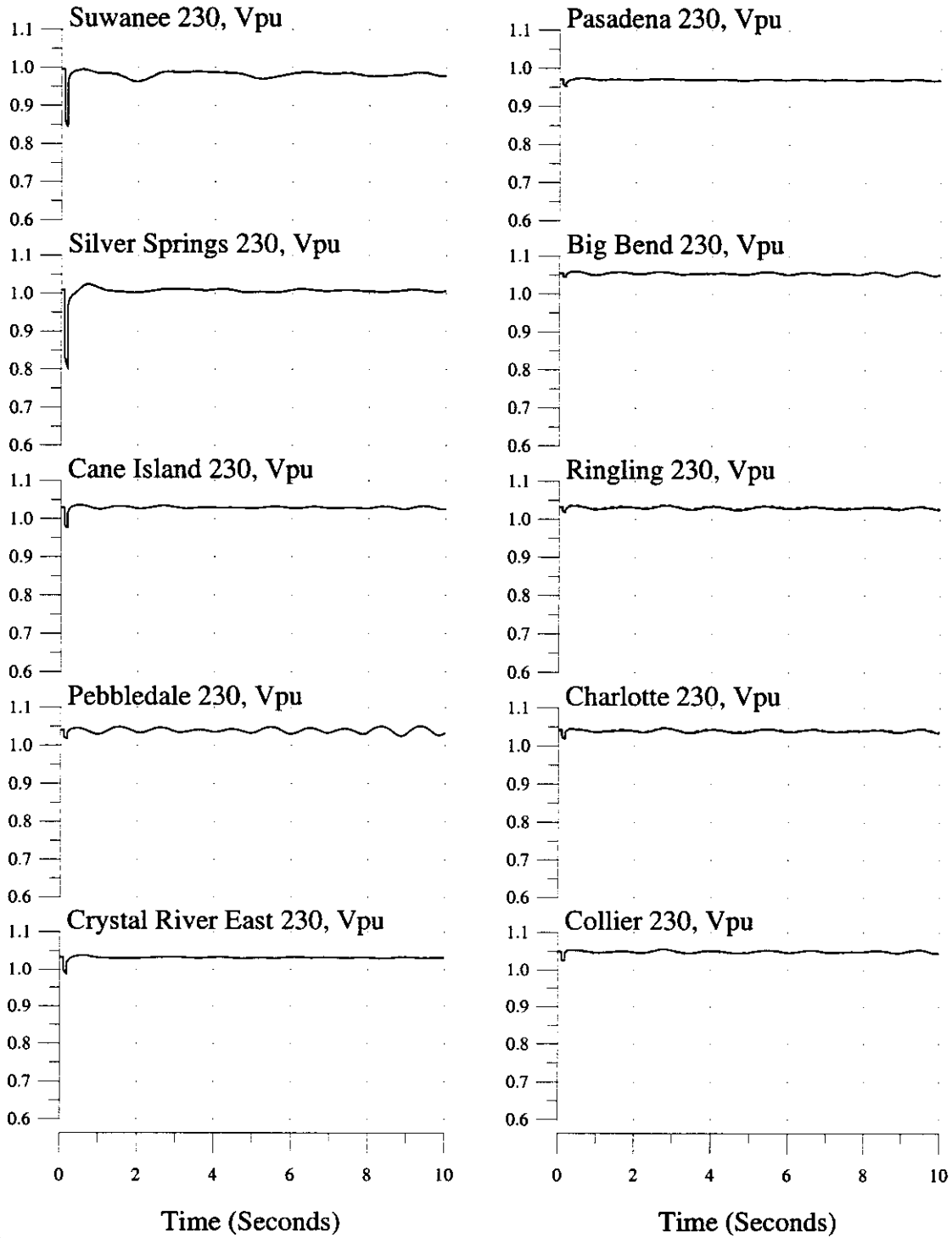

3-phase, 5-cycle Fault at Martin 500kV Bus, Trip Poinsett-Martin 500kV Line
2003 Summer System

Machine & Interface Variables: (—) With Okeechobee So. FPL Dispatch, (...) Without

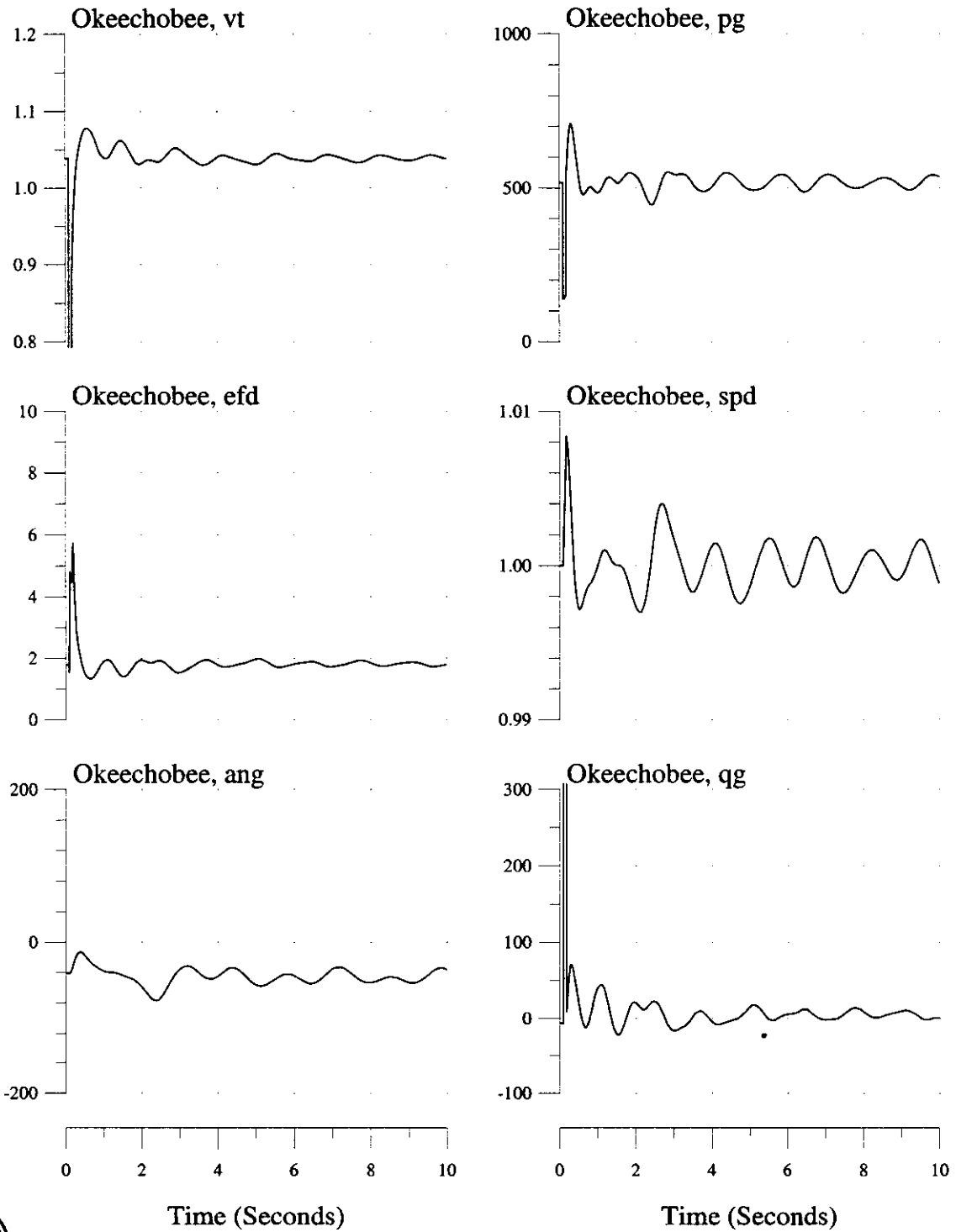

3-phase, 5-cycle Fault at Martin 500kV Bus, Trip Poinsett-Martin 500kV Line
2003 Summer System

Machine & Interface Variables: (—) With Okeechobee So. FPL Dispatch, (...) Without

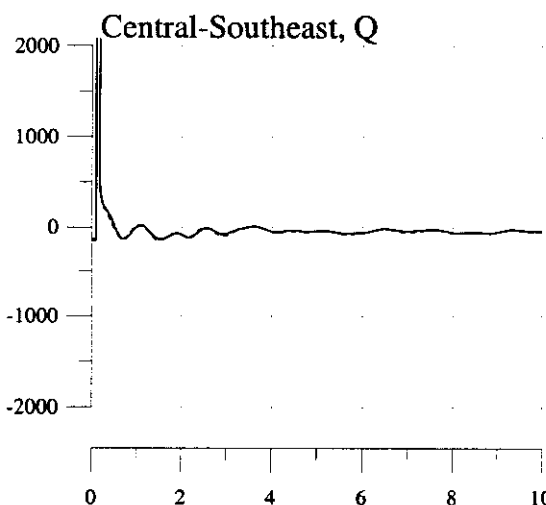
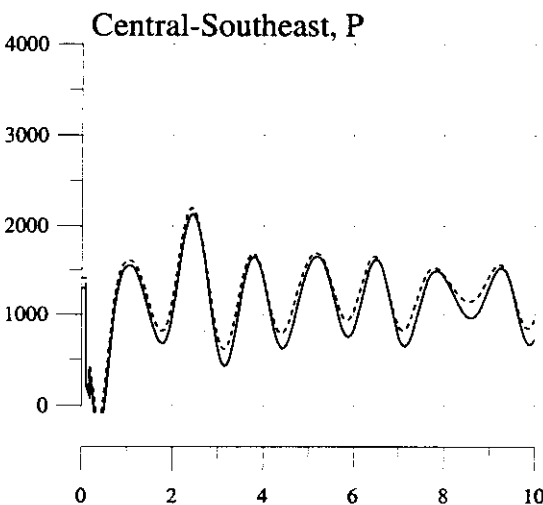
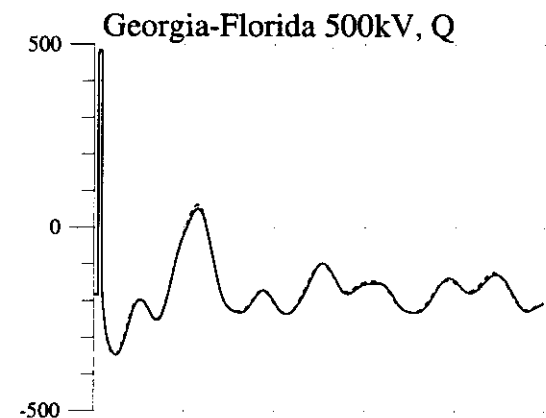
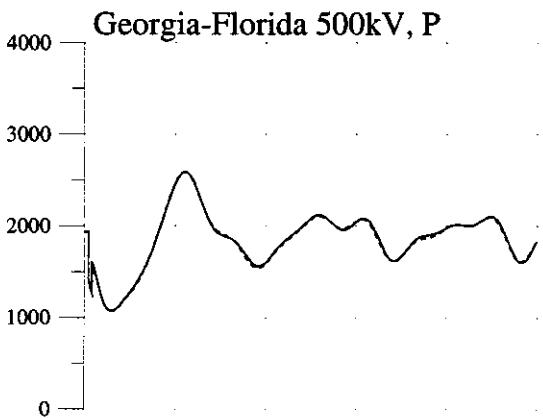
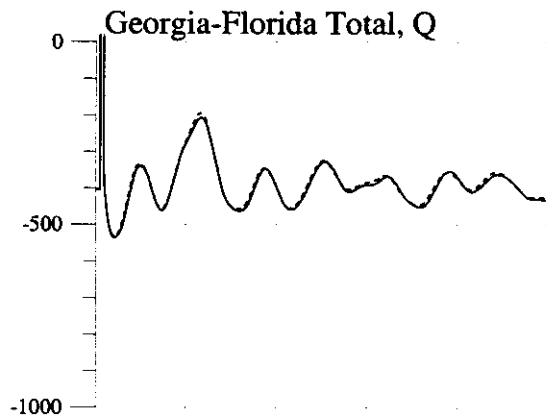
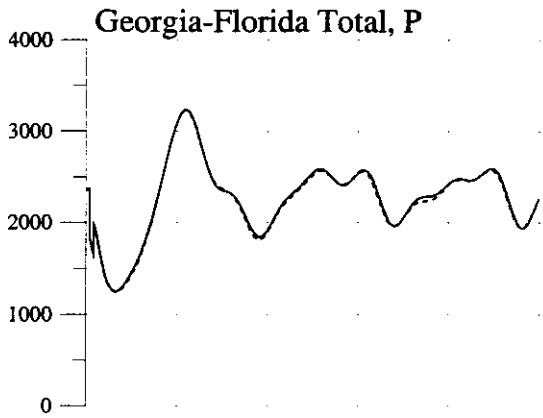

Time (Seconds)

Time (Seconds)



3-phase, 5-cycle Fault at Martin 500kV Bus, Trip Poinsett-Martin 500kV Line
 2003 Summer System

Machine Variables: (—) With Okeechobee So. FPL Dispatch, (...) Without

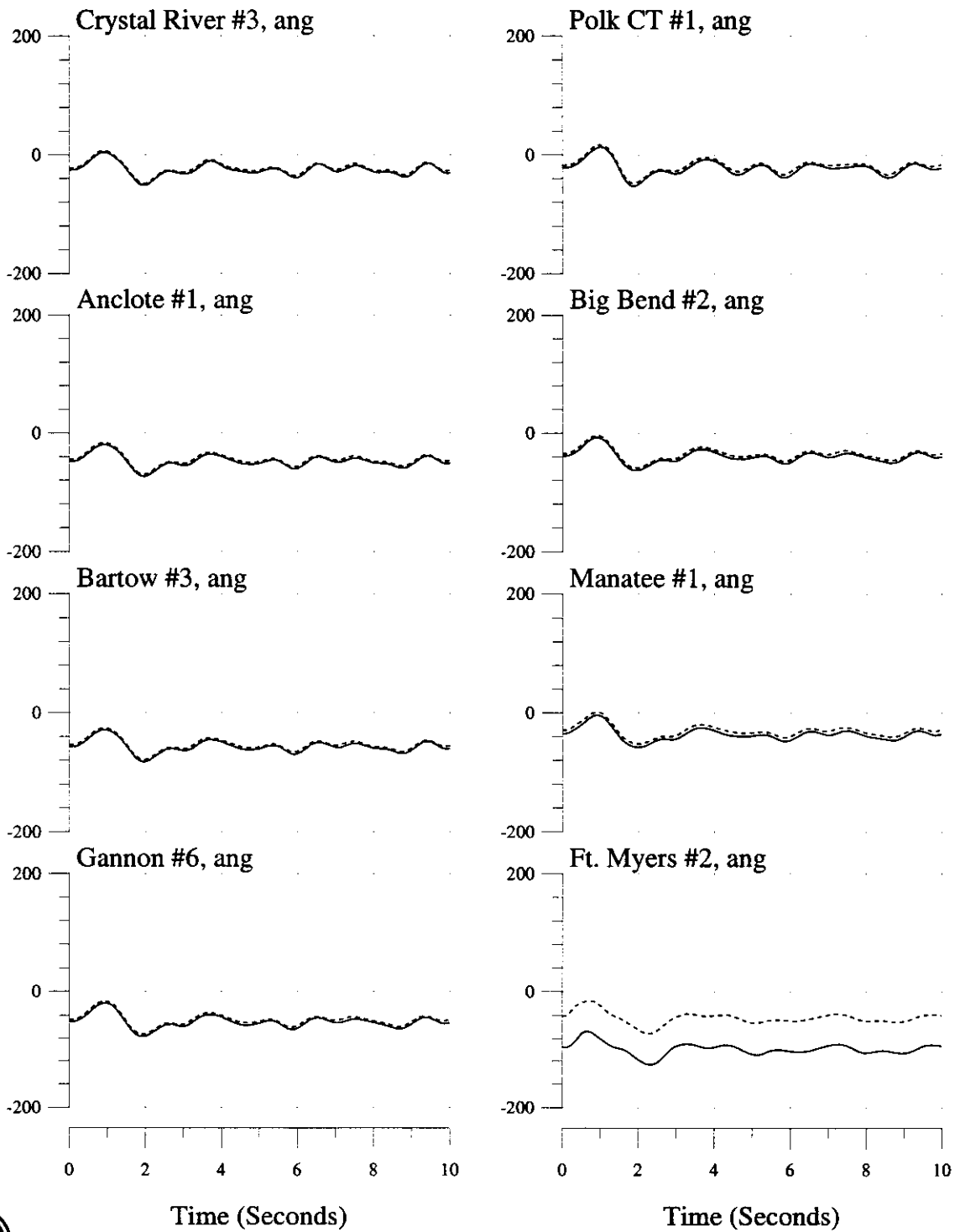

3-phase, 5-cycle Fault at Martin 500kV Bus, Trip Poinsett-Martin 500kV Line
 2003 Summer System

Machine Variables: (—) With Okeechobee So. FPL Dispatch, (...) Without

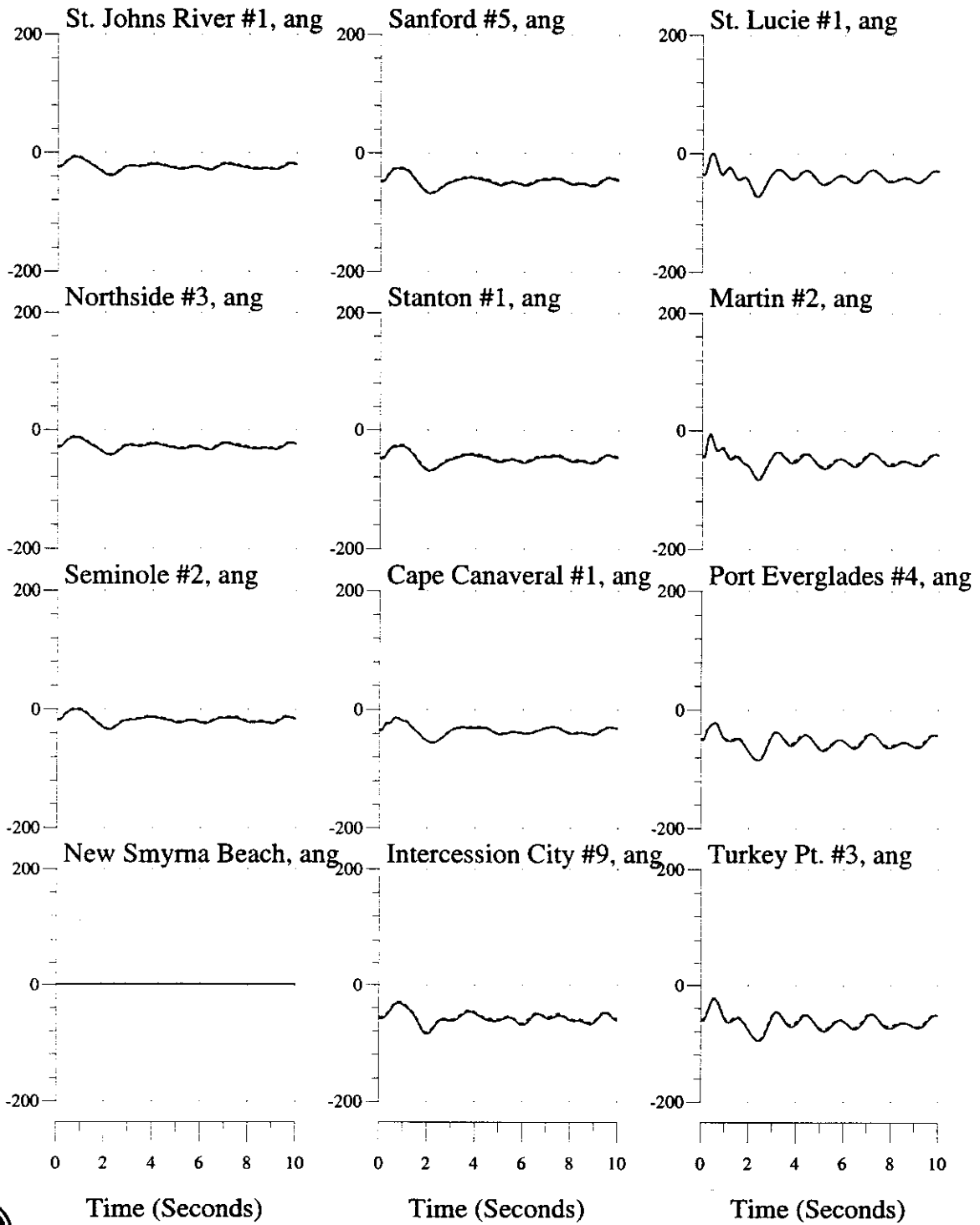

3-phase, 5-cycle Fault at Martin 500kV Bus, Trip Poinsett-Martin 500kV Line
 2003 Summer System

Bus Variables: (—) With Okeechobee So. FPL Dispatch, (...) Without

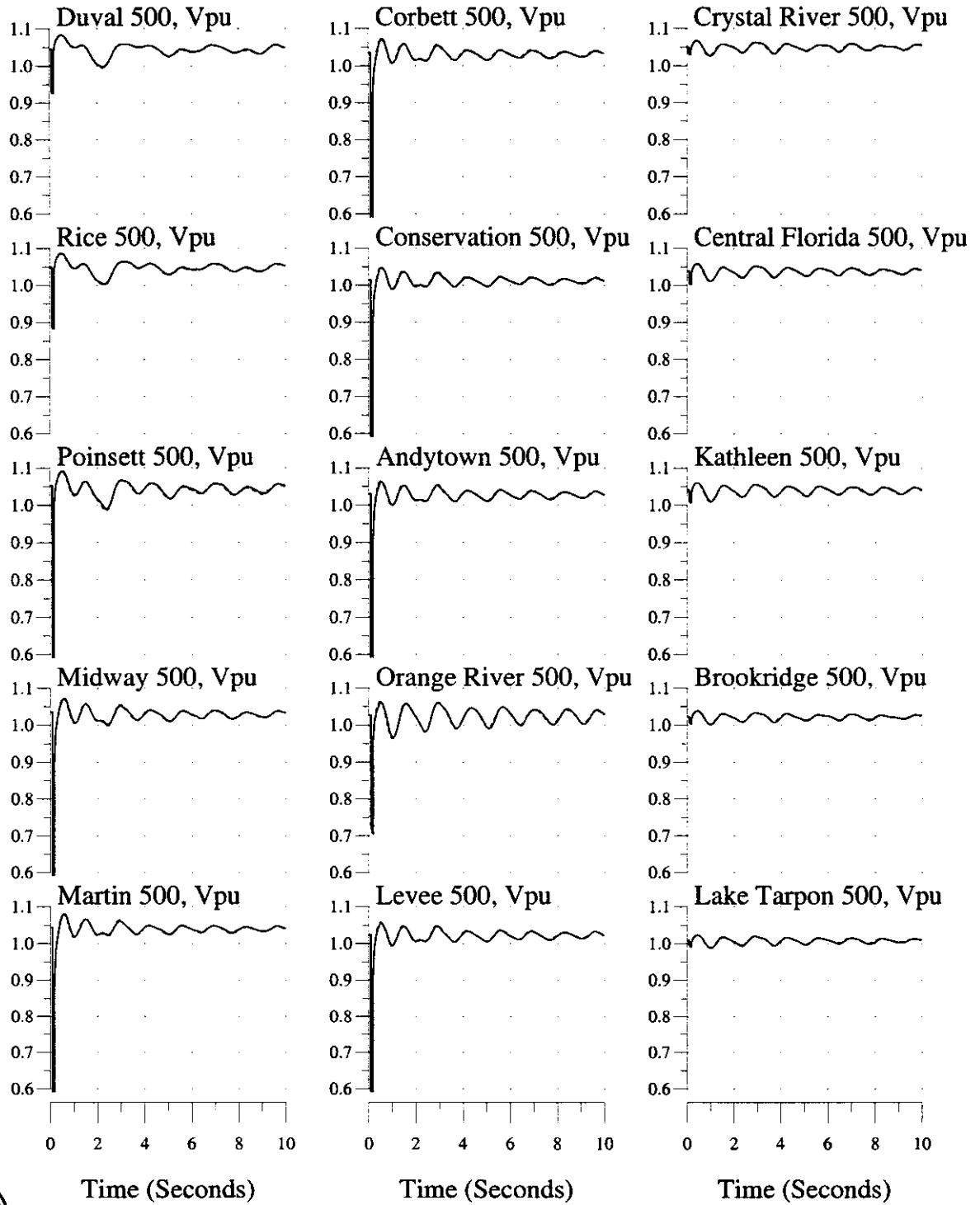

3-phase, 5-cycle Fault at Martin 500kV Bus, Trip Poinsett-Martin 500kV Line
2003 Summer System

Bus Variables: (___) With Okeechobee So. FPL Dispatch, (...) Without

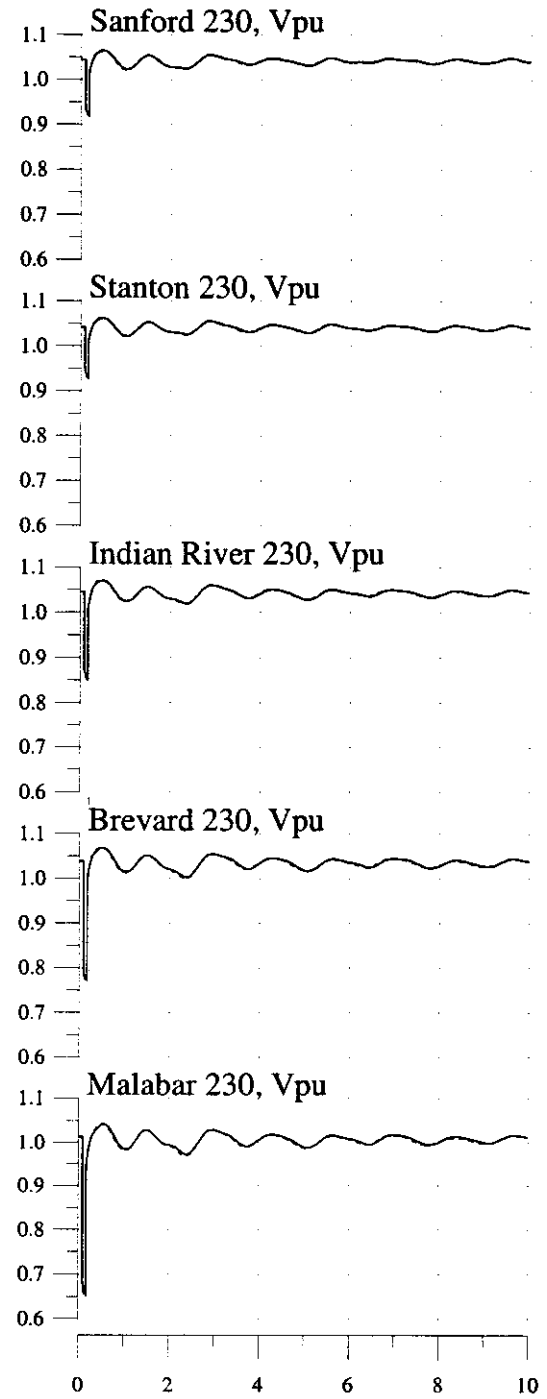
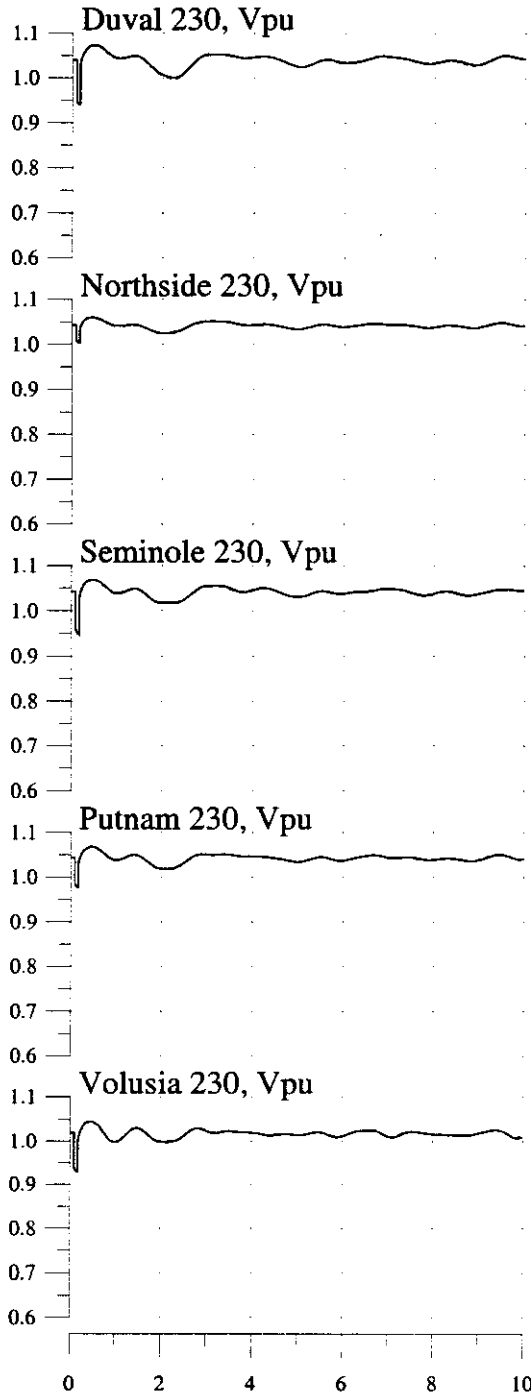

3-phase, 5-cycle Fault at Martin 500kV Bus, Trip Poinsett-Martin 500kV Line
2003 Summer System

Bus Variables: (—) With Okeechobee So. FPL Dispatch, (...) Without

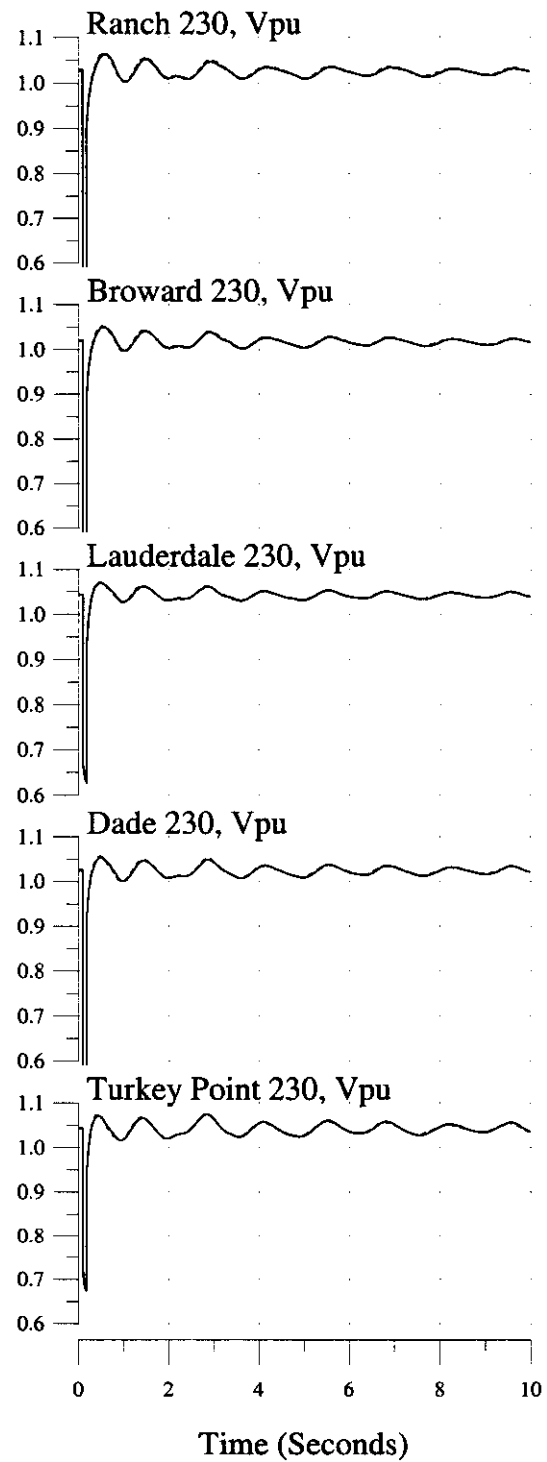
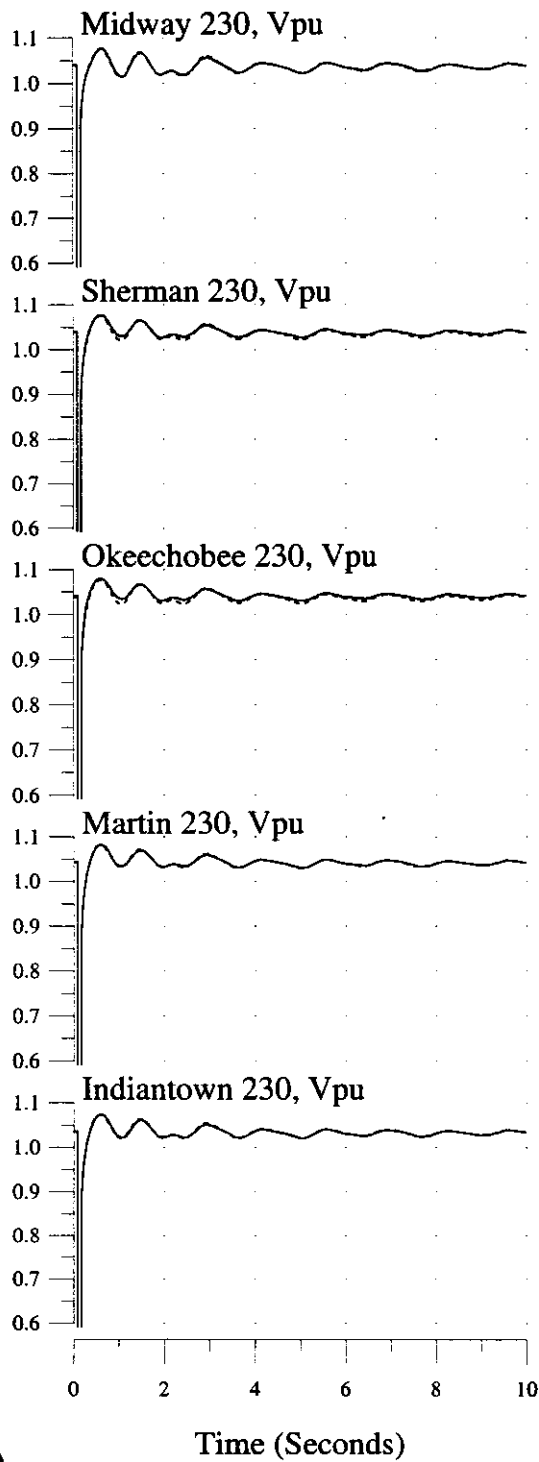

3-phase, 5-cycle Fault at Martin 500kV Bus, Trip Poinsett-Martin 500kV Line
2003 Summer System

Bus Variables: (___) With Okeechobee So. FPL Dispatch, (...) Without

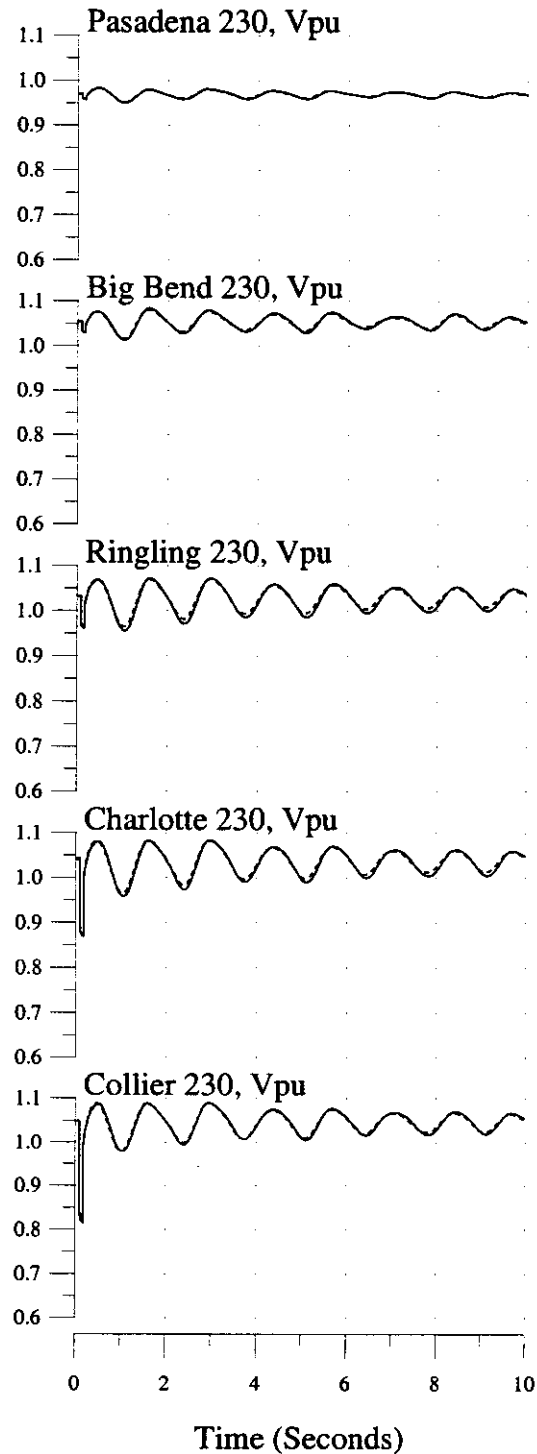
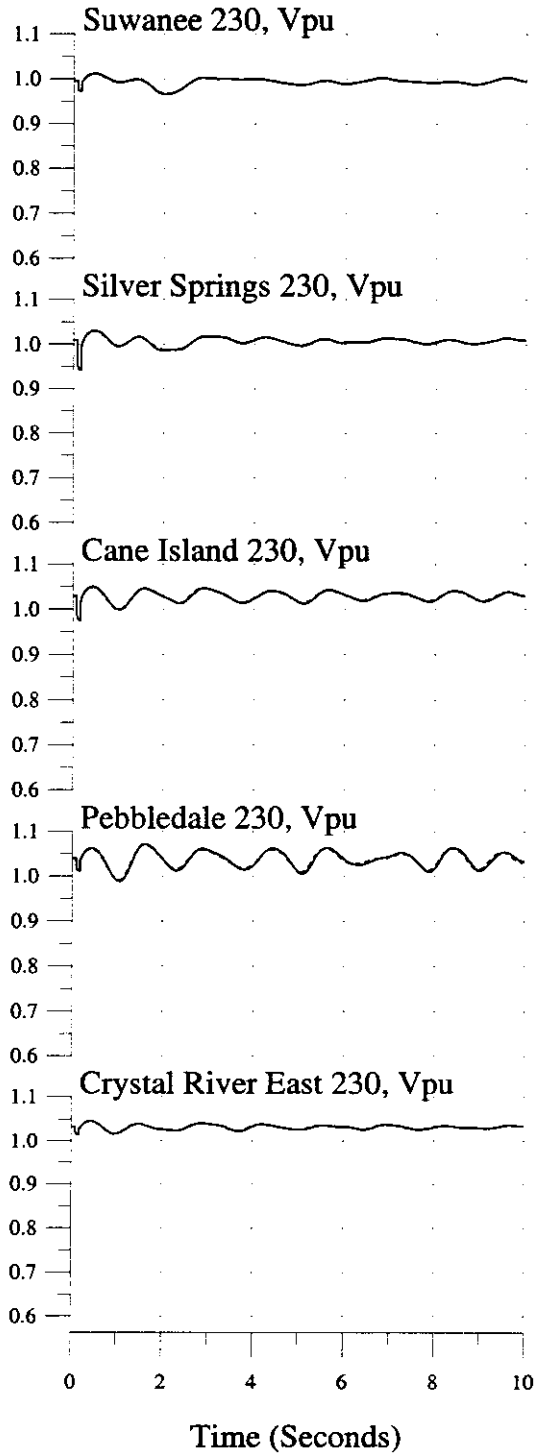

3-phase, 5-cycle Fault at Okeechobee 230kV Bus, Trip Okeechobee-Sherman 230kV Line
2003 Summer System

Machine & Interface Variables: (___) With Okeechobee So. FPL Dispatch, (...) Without

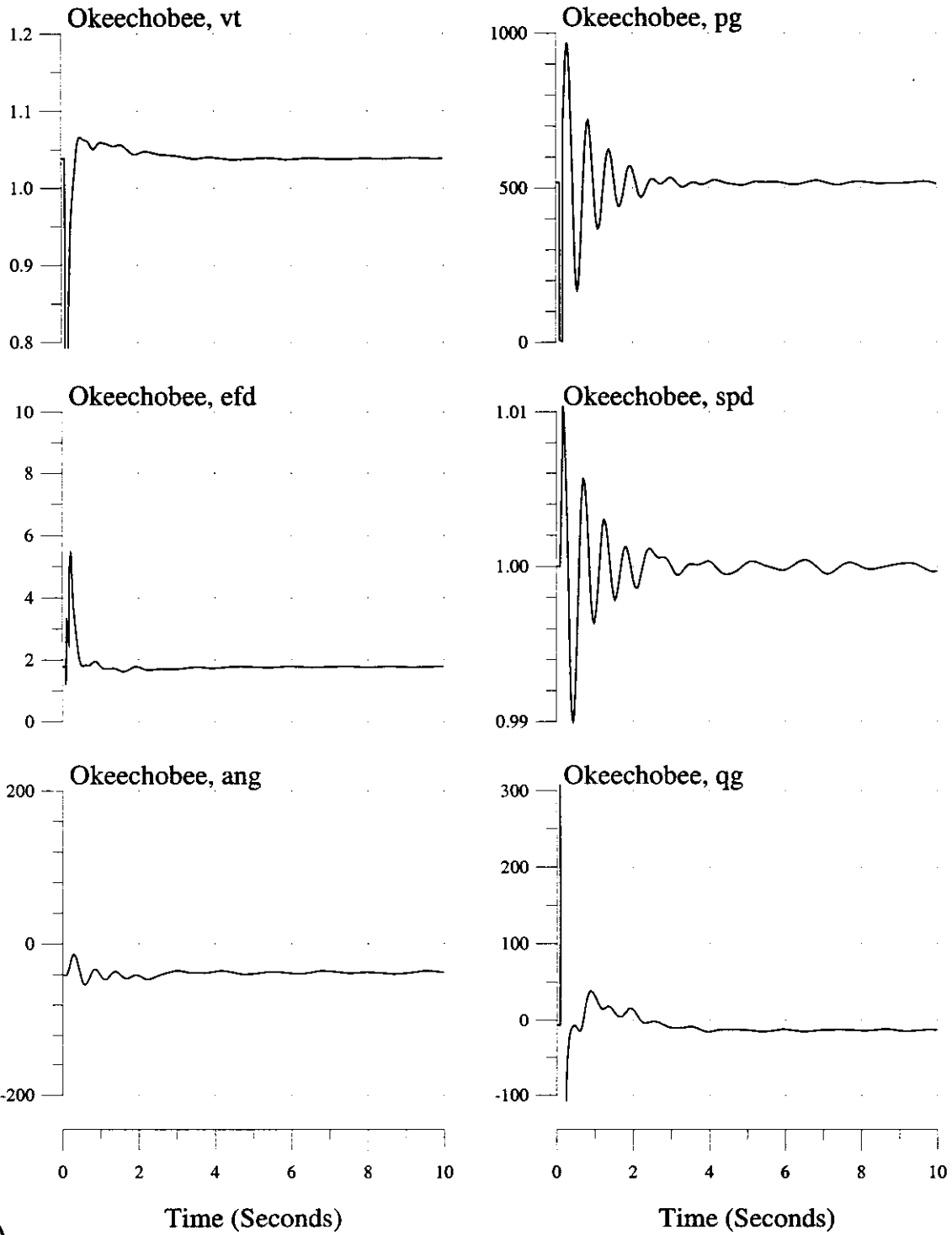

3-phase, 5-cycle Fault at Okeechobee 230kV Bus, Trip Okeechobee-Sherman 230kV Line
2003 Summer System

Machine & Interface Variables: (—) With Okeechobee So. FPL Dispatch, (...) Without

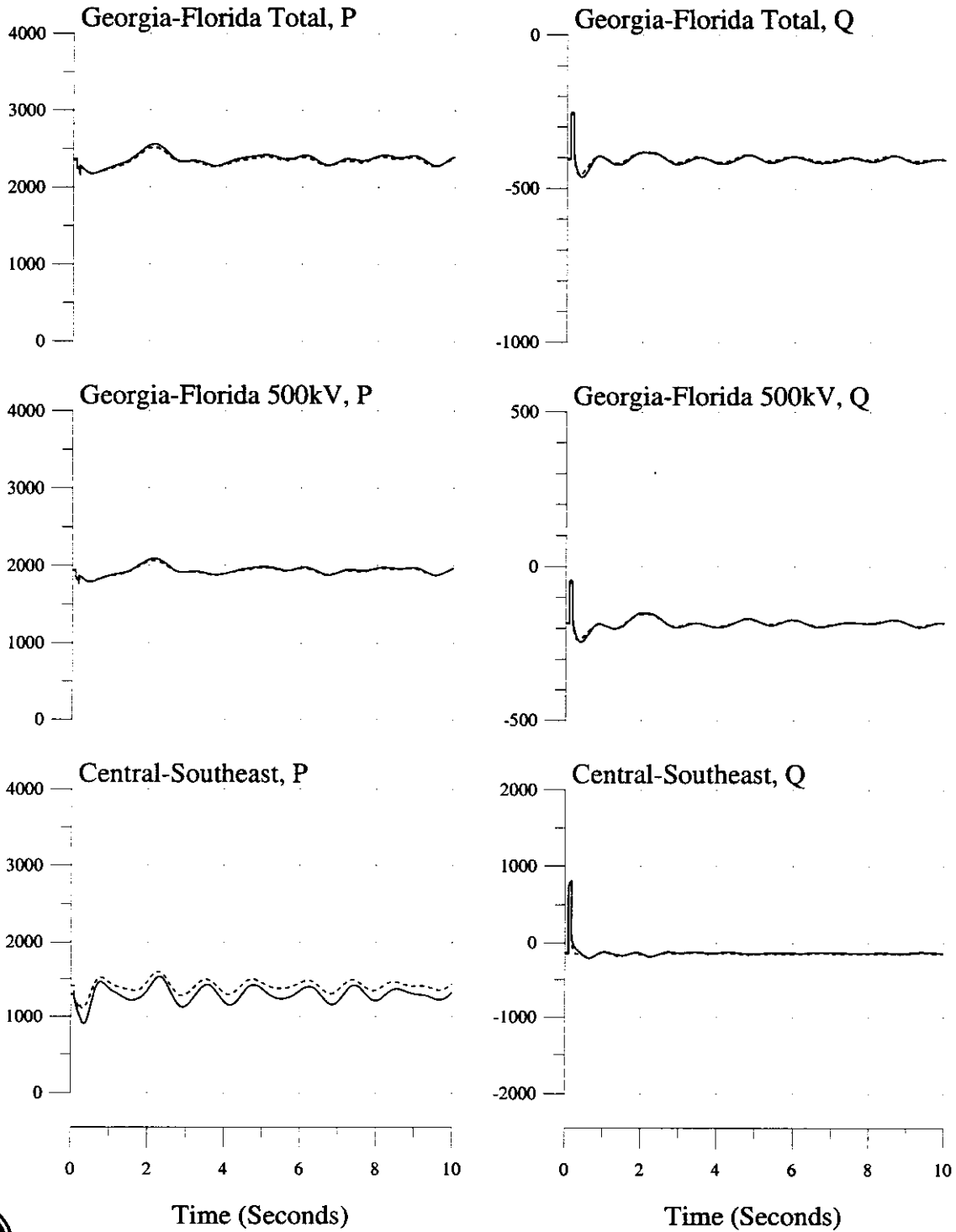

3-phase, 5-cycle Fault at Okeechobee 230kV Bus, Trip Okeechobee-Sherman 230kV Line
2003 Summer System

Machine Variables: (—) With Okeechobee So. FPL Dispatch, (...) Without

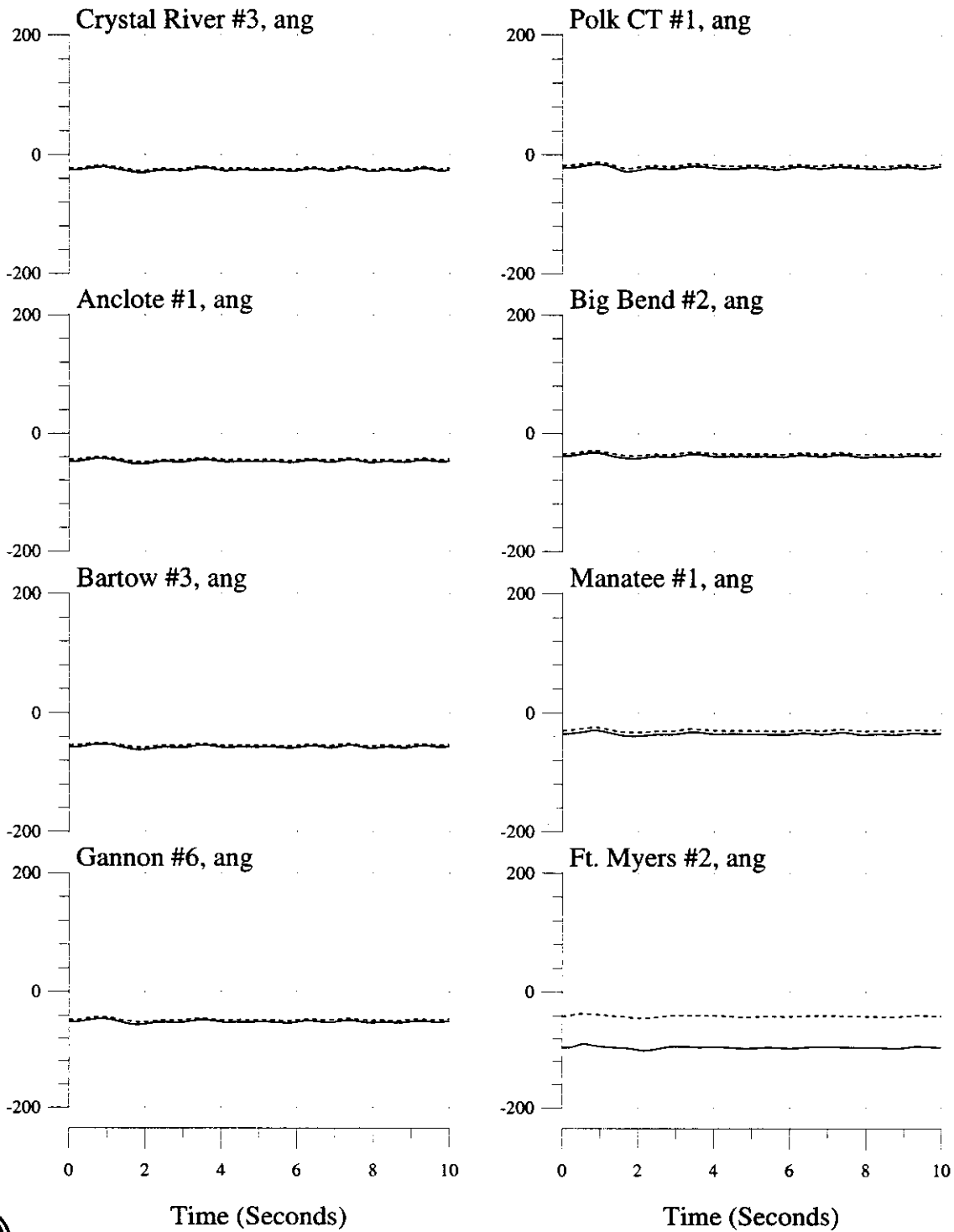

3-phase, 5-cycle Fault at Okeechobee 230kV Bus, Trip Okeechobee-Sherman 230kV Line
 2003 Summer System

Machine Variables: (___) With Okeechobee So. FPL Dispatch, (...) Without

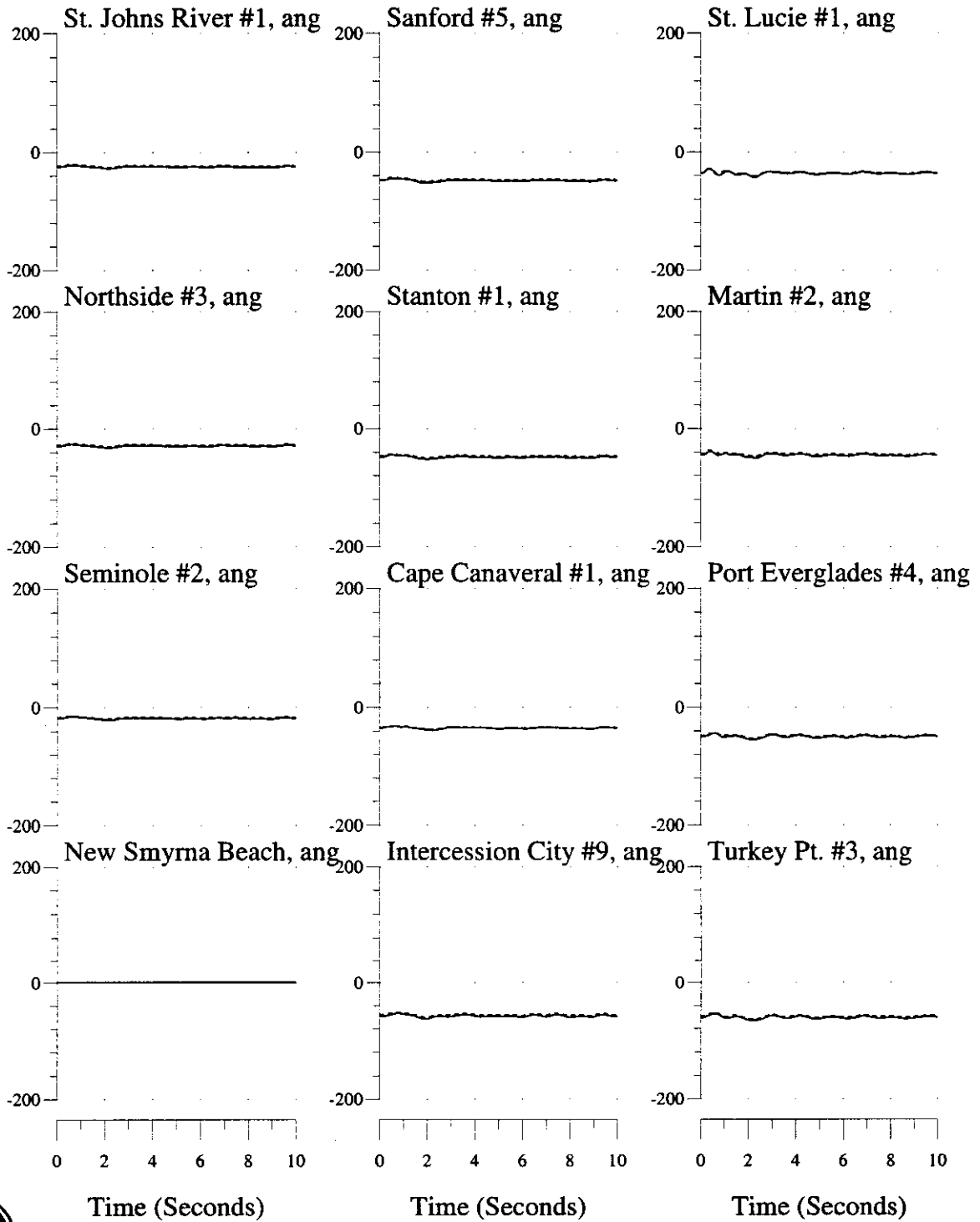

3-phase, 5-cycle Fault at Okeechobee 230kV Bus, Trip Okeechobee-Sherman 230kV Line
 2003 Summer System

Bus Variables: (—) With Okeechobee So. FPL Dispatch, (...) Without

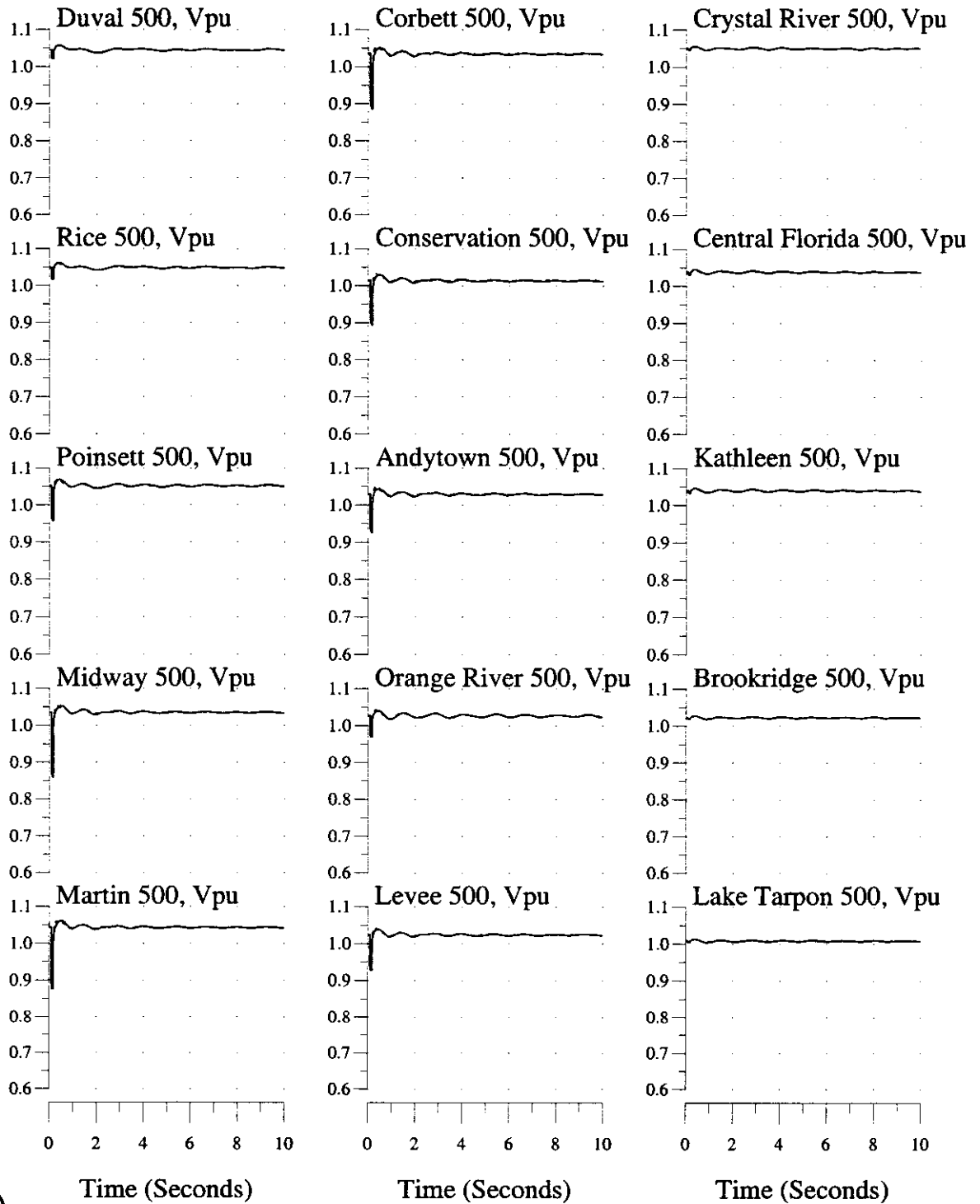

3-phase, 5-cycle Fault at Okeechobee 230kV Bus, Trip Okeechobee-Sherman 230kV Line 2003 Summer System

Bus Variables: (___) With Okeechobee So. FPL Dispatch, (...) Without

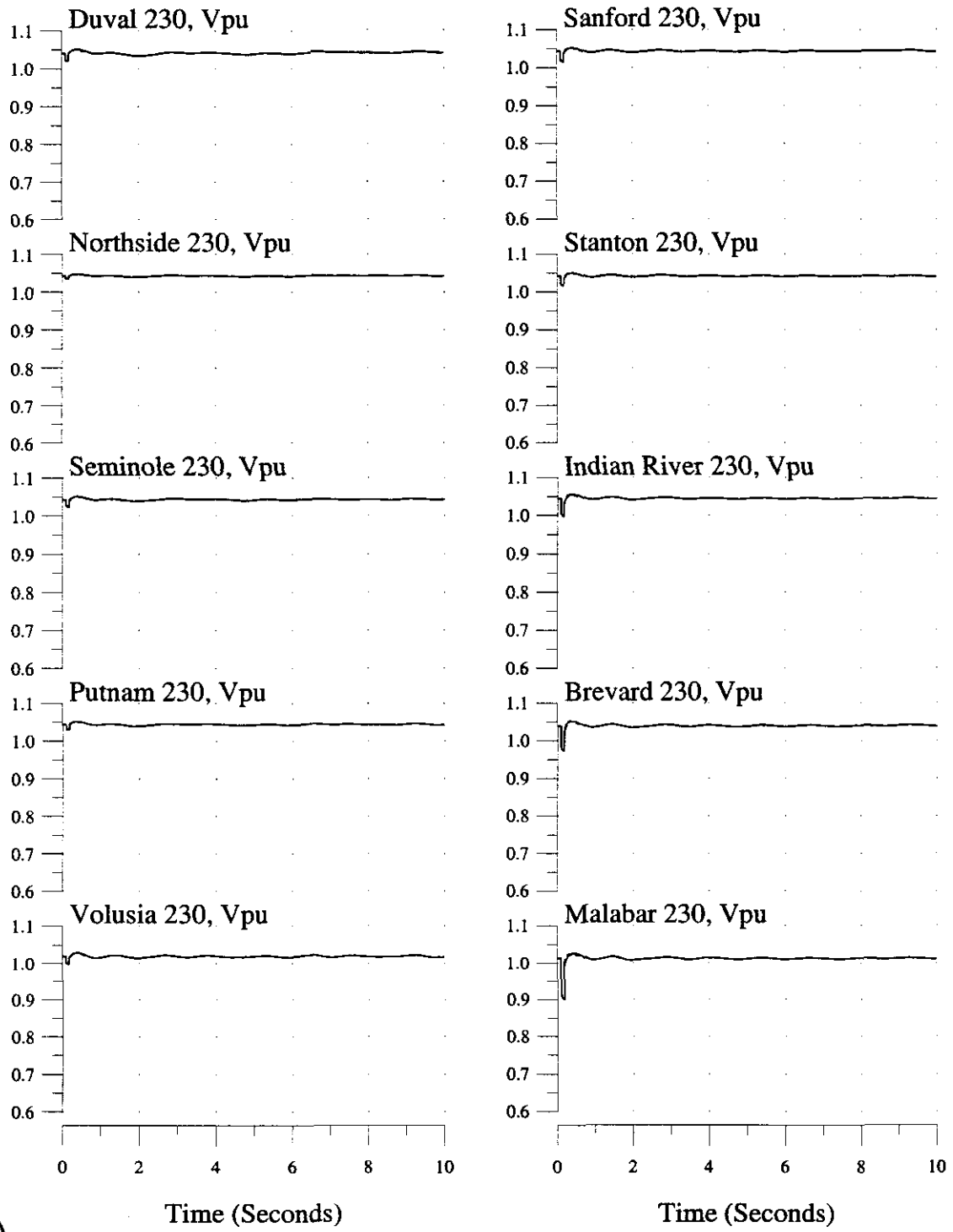

3-phase, 5-cycle Fault at Okeechobee 230kV Bus, Trip Okeechobee-Sherman 230kV Line
2003 Summer System

Bus Variables: (___) With Okeechobee So. FPL Dispatch, (...) Without

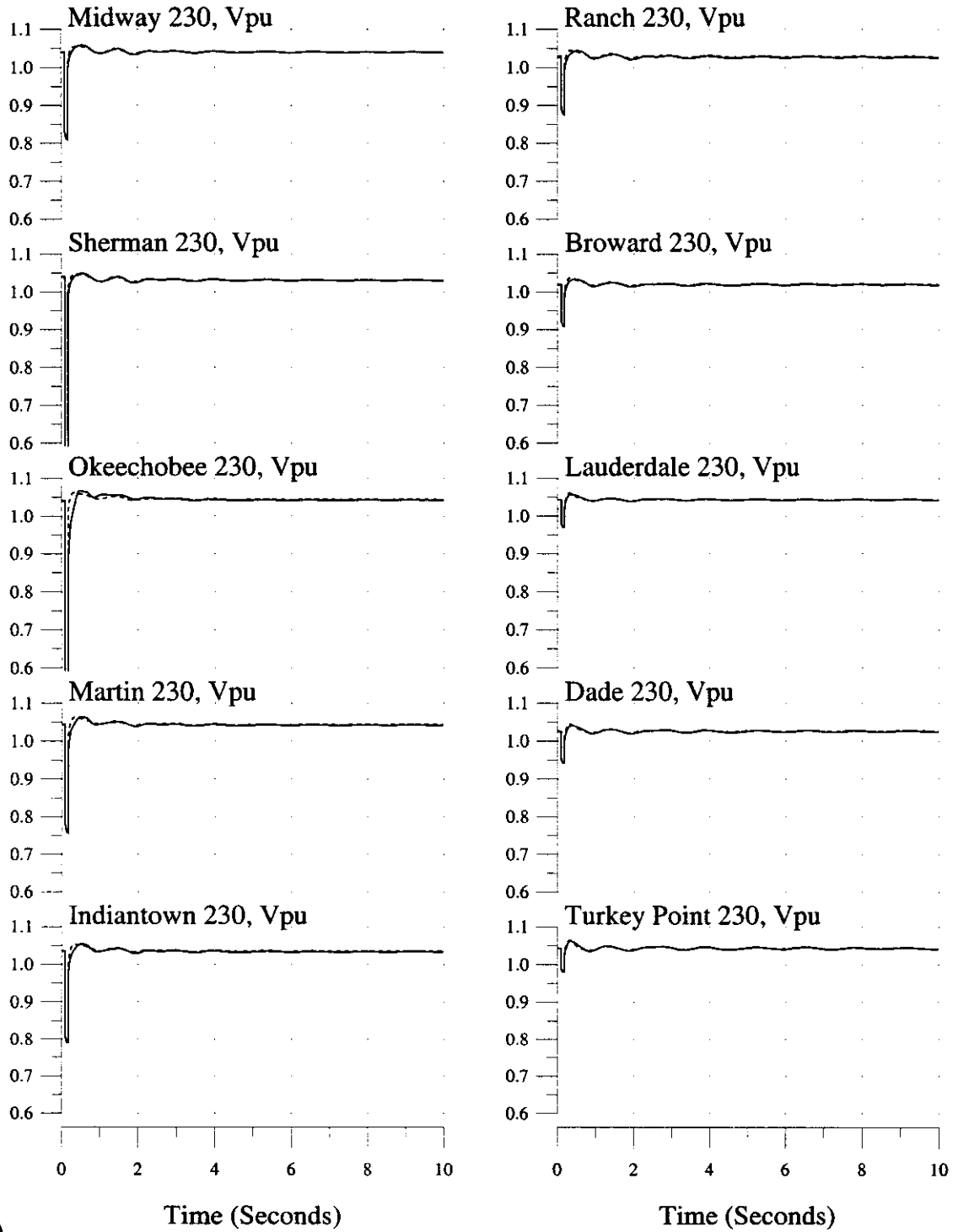

3-phase, 5-cycle Fault at Okeechobee 230kV Bus, Trip Okeechobee-Sherman 230kV Line
2003 Summer System

Bus Variables: (—) With Okeechobee So. FPL Dispatch, (...) Without

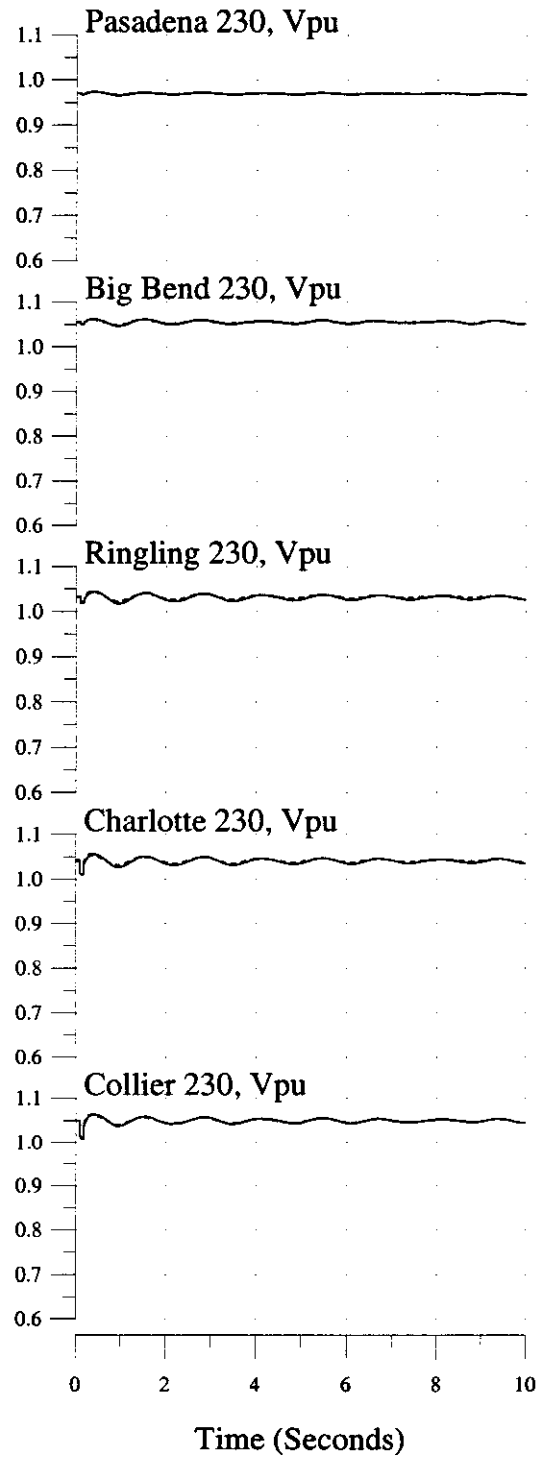
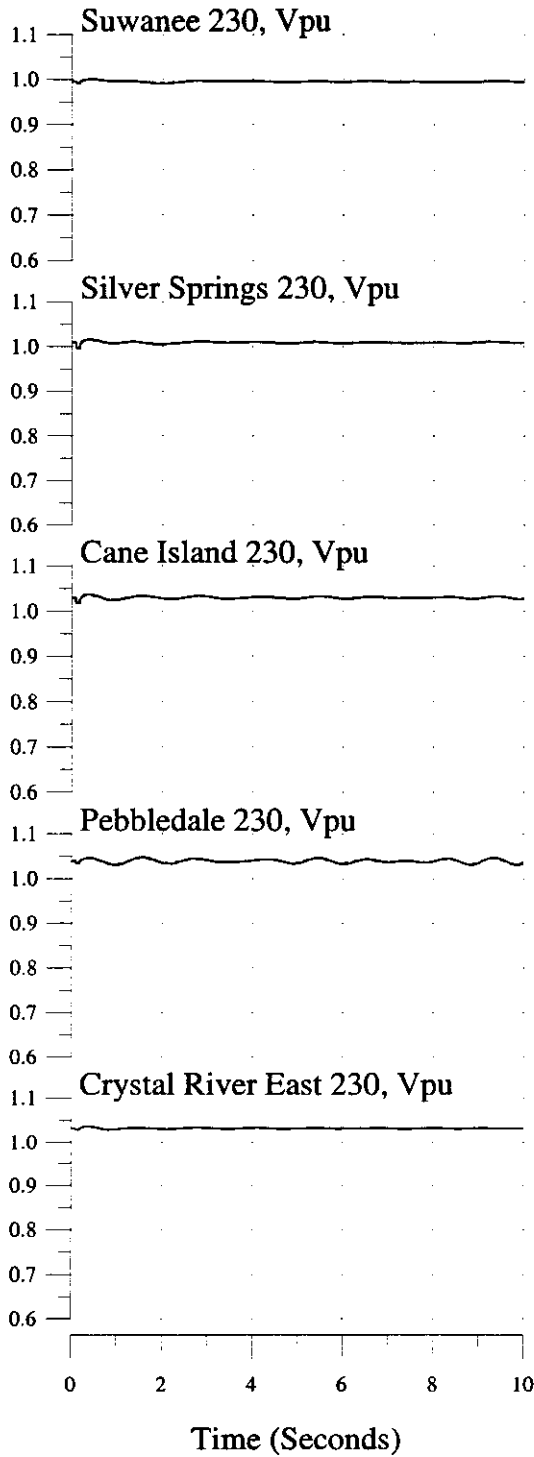

3-phase, 5-cycle Fault at Okeechobee 230kV Bus, Trip Okeechobee-Martin 230kV Line
2003 Summer System

Machine & Interface Variables: (—) With Okeechobee So. FPL Dispatch, (...) Without

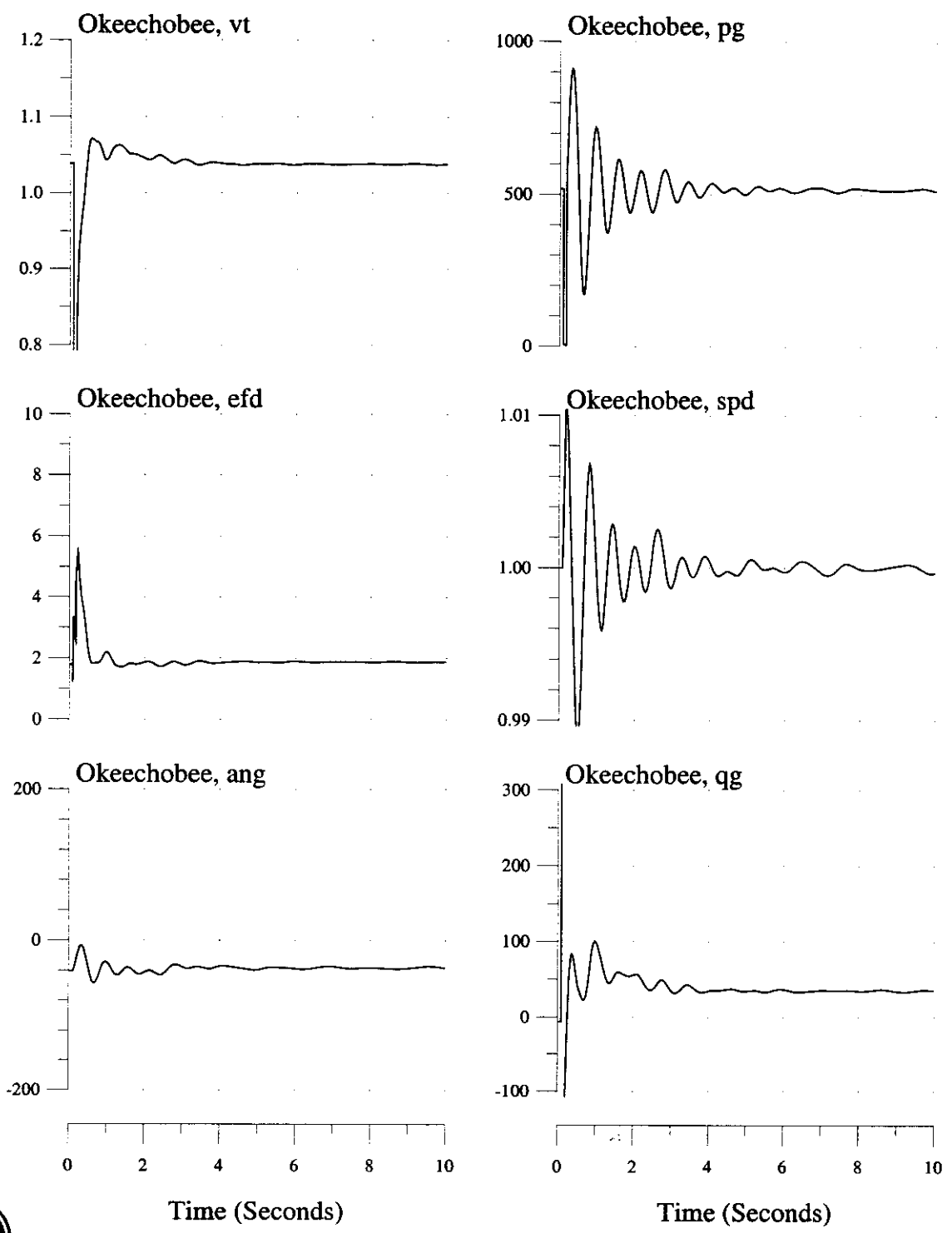

3-phase, 5-cycle Fault at Okeechobee 230kV Bus, Trip Okeechobee-Martin 230kV Line
2003 Summer System

Machine & Interface Variables: (—) With Okeechobee So. FPL Dispatch, (...) Without

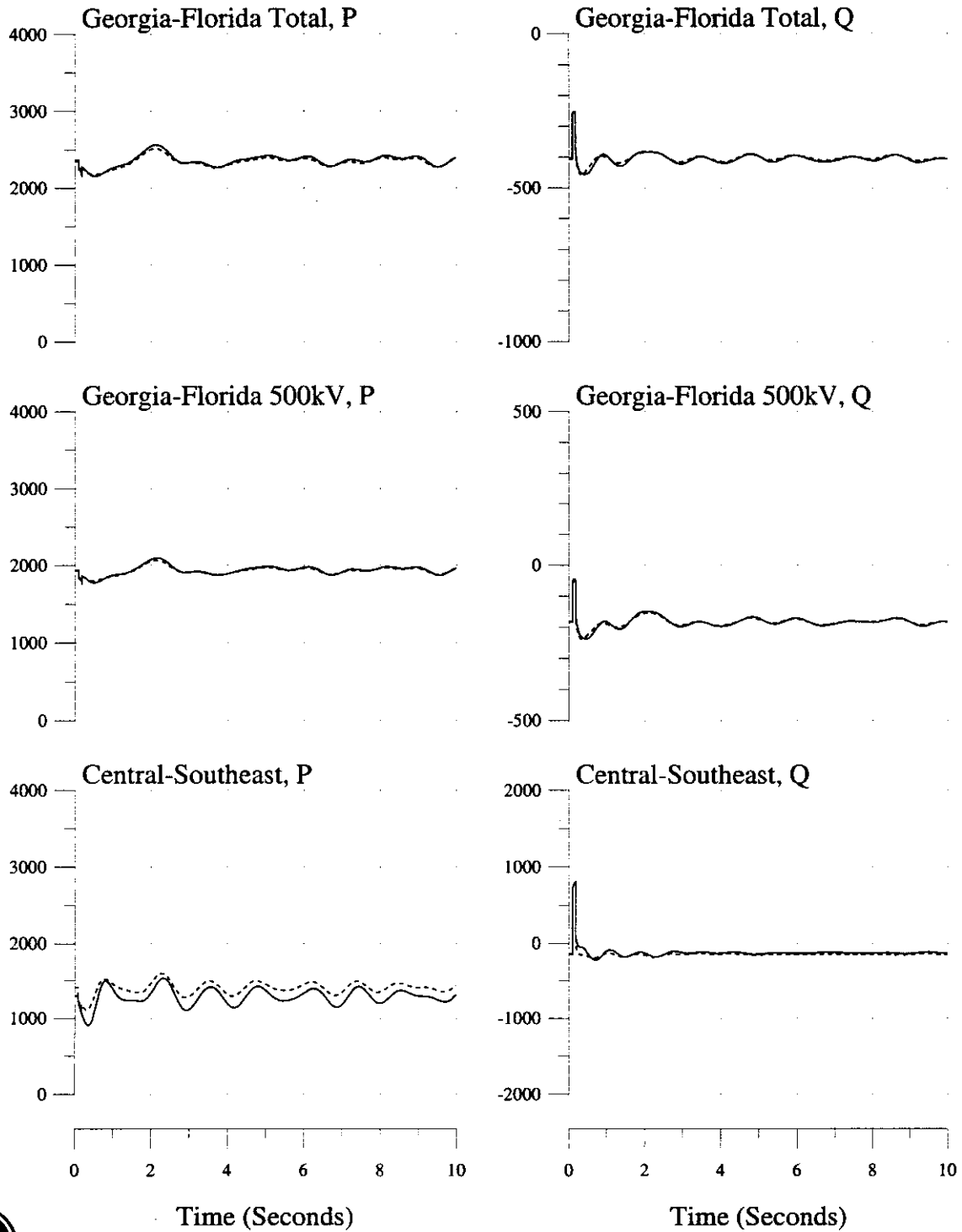

3-phase, 5-cycle Fault at Okeechobee 230kV Bus, Trip Okeechobee-Martin 230kV Line
2003 Summer System

Machine Variables: (—) With Okeechobee So. FPL Dispatch, (...) Without

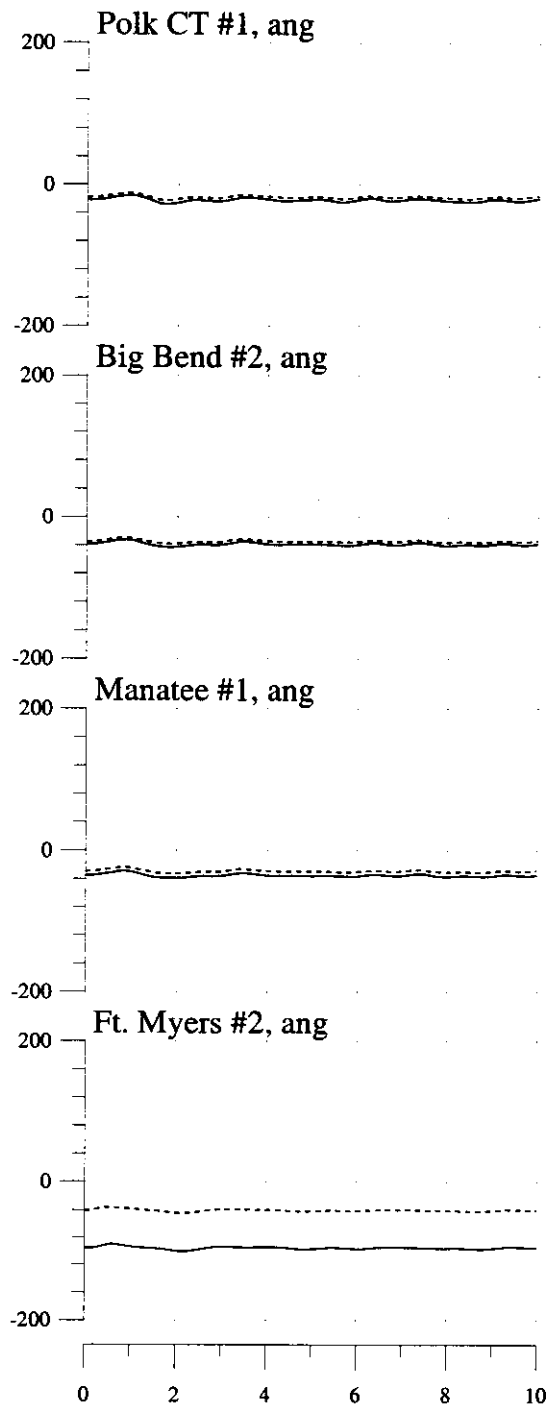
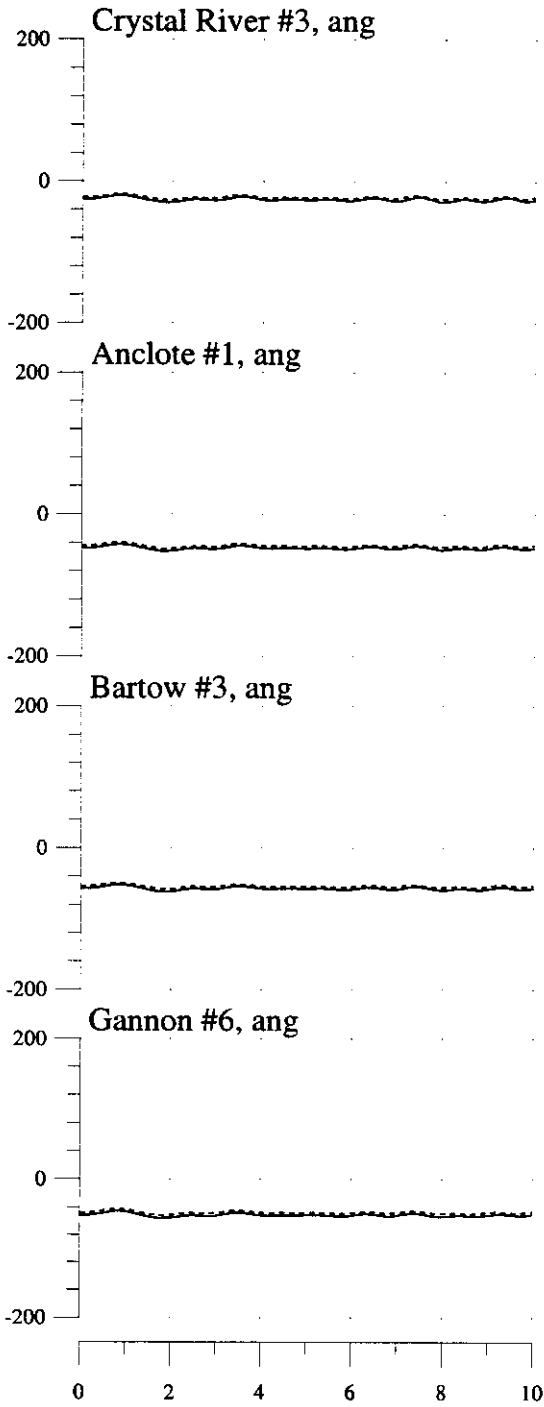

3-phase, 5-cycle Fault at Okeechobee 230kV Bus, Trip Okeechobee-Martin 230kV Line
2003 Summer System

Machine Variables: (___) With Okeechobee So. FPL Dispatch, (...) Without

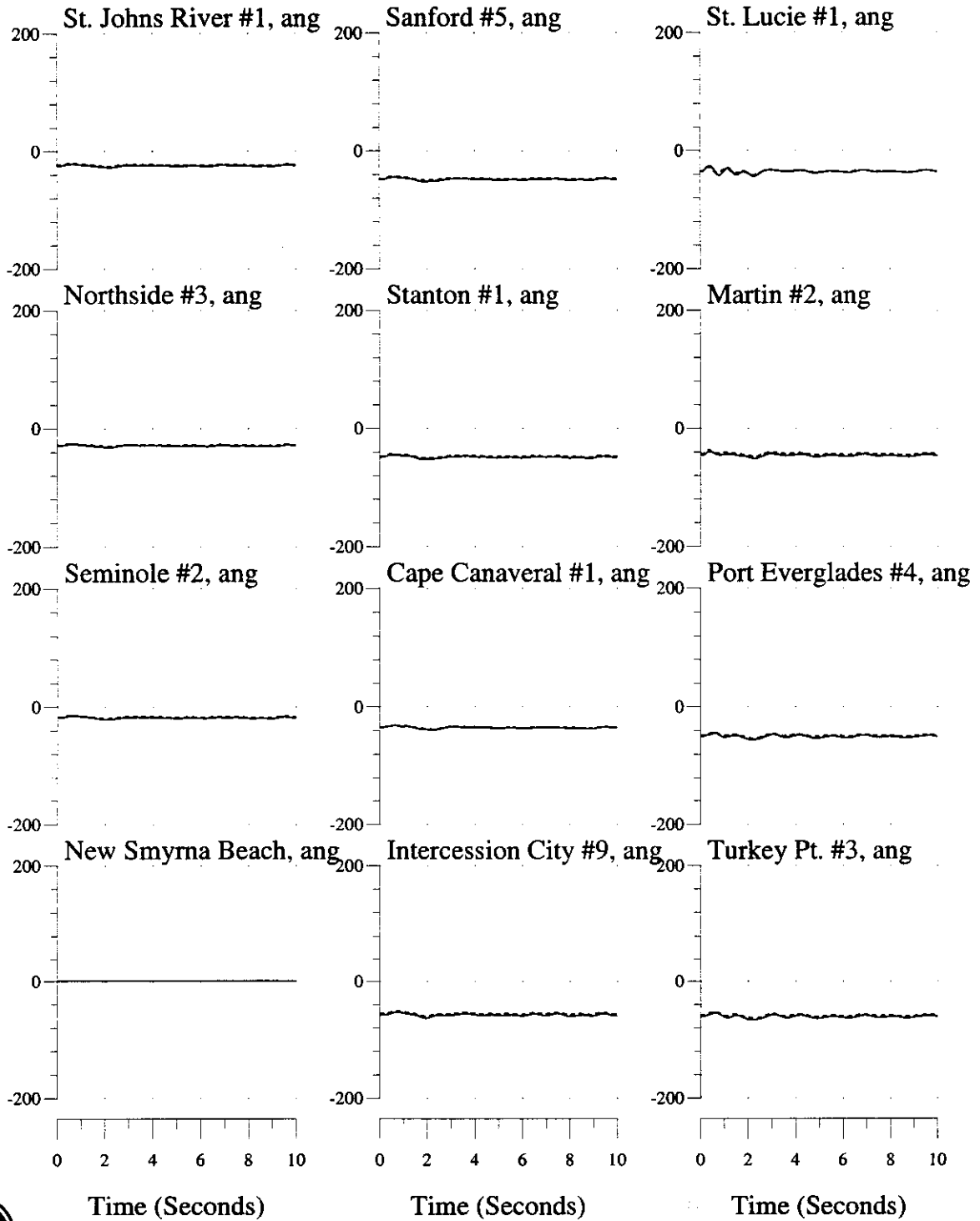

3-phase, 5-cycle Fault at Okeechobee 230kV Bus, Trip Okeechobee-Martin 230kV Line
 2003 Summer System

Bus Variables: (—) With Okeechobee So. FPL Dispatch, (...) Without

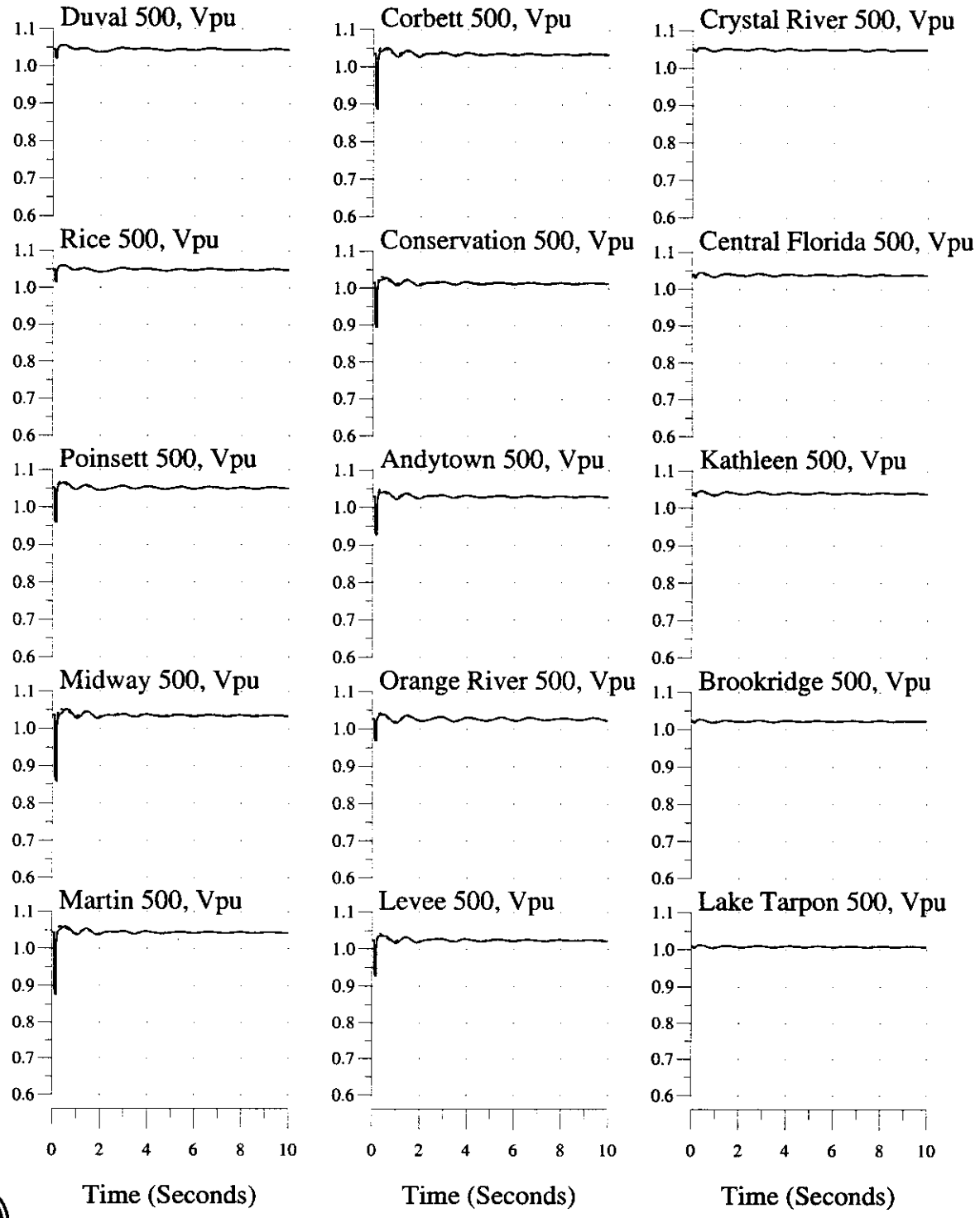

3-phase, 5-cycle Fault at Okeechobee 230kV Bus, Trip Okeechobee-Martin 230kV Line
2003 Summer System

Bus Variables: (___) With Okeechobee So. FPL Dispatch, (...) Without

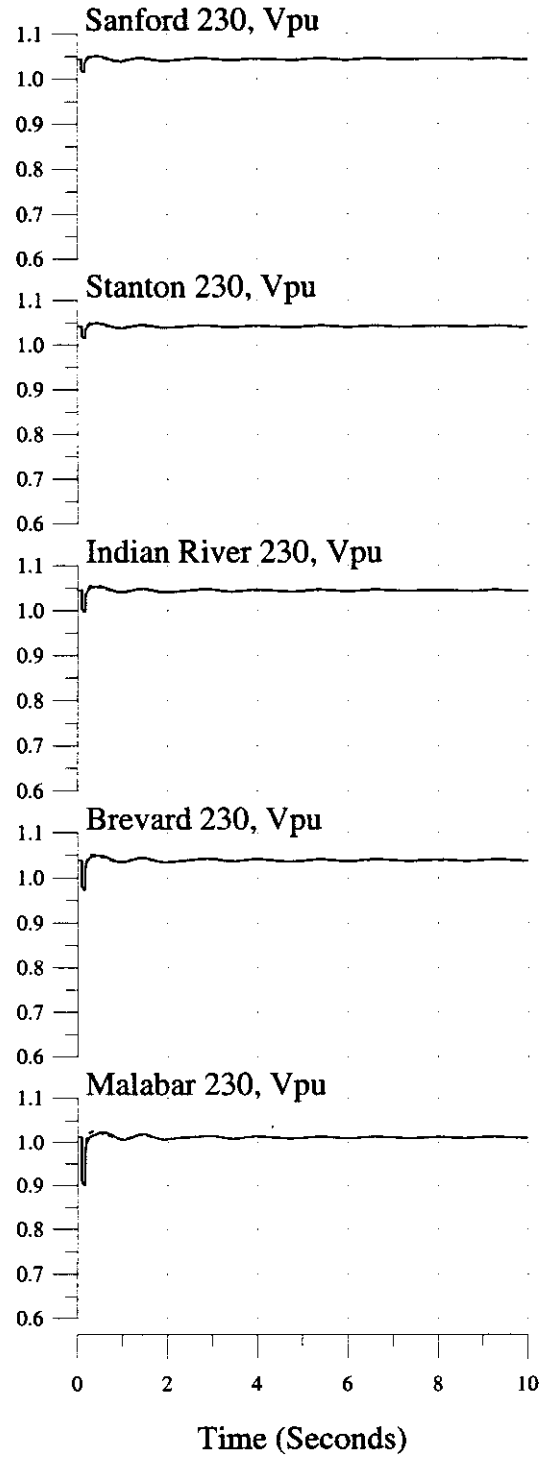
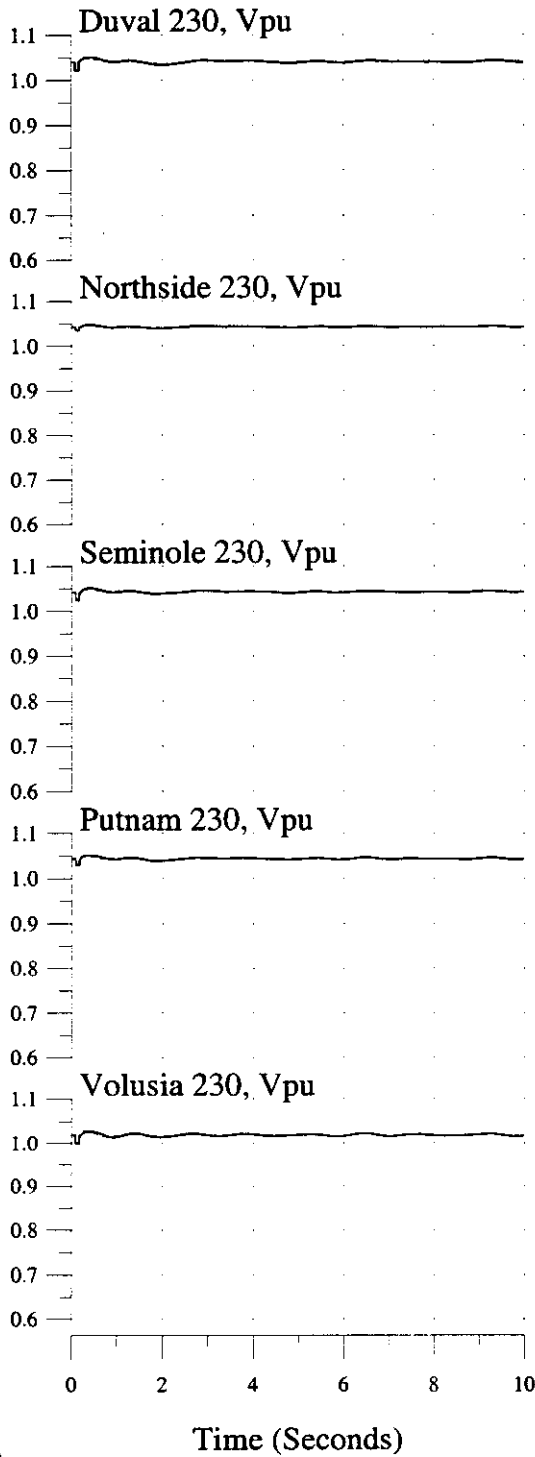

3-phase, 5-cycle Fault at Okeechobee 230kV Bus, Trip Okeechobee-Martin 230kV Line
2003 Summer System

Bus Variables: (—) With Okeechobee So. FPL Dispatch, (...) Without

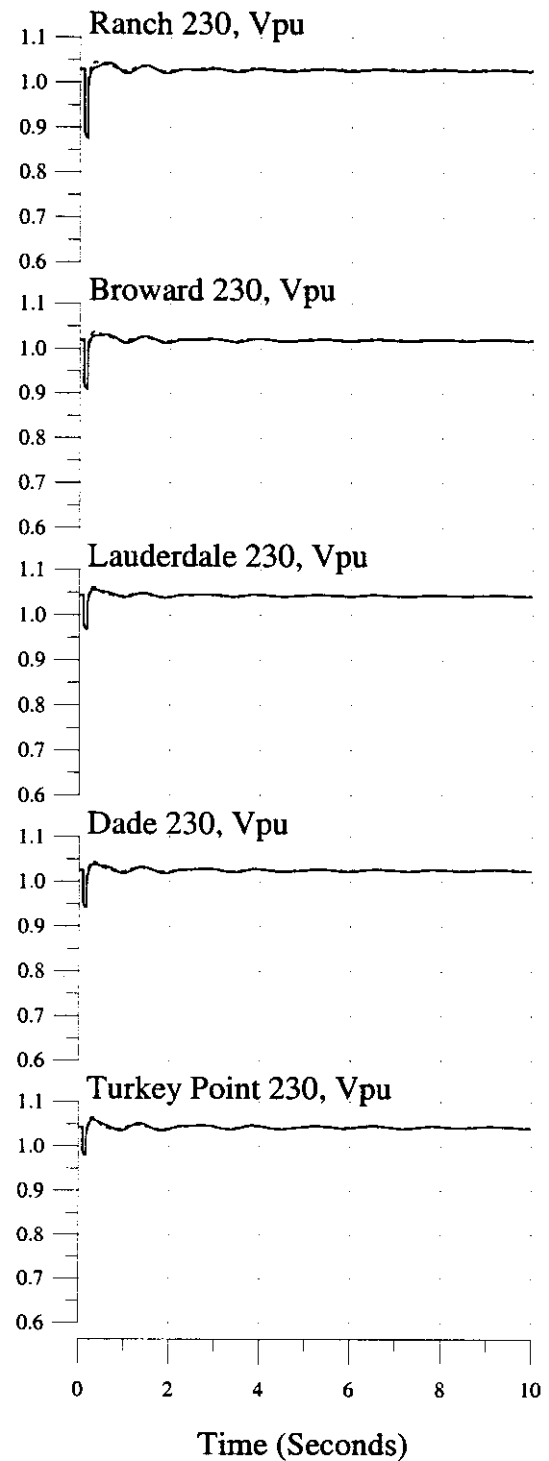
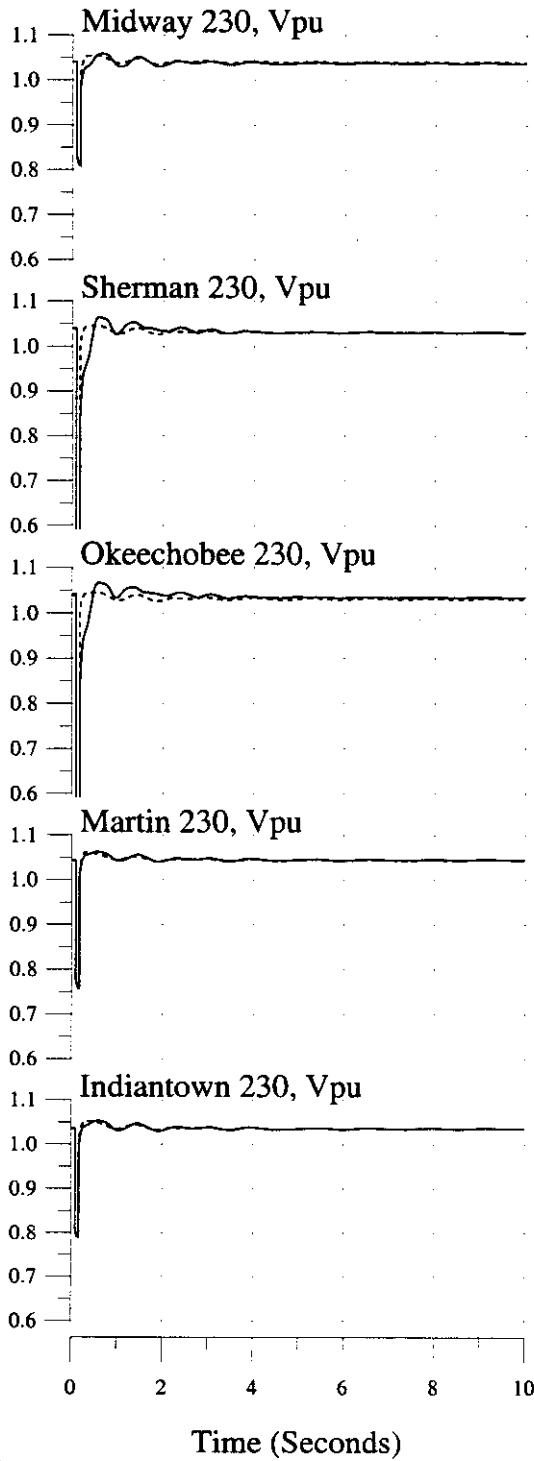

3-phase, 5-cycle Fault at Okeechobee 230kV Bus, Trip Okeechobee-Martin 230kV Line
2003 Summer System

Bus Variables: (___) With Okeechobee So. FPL Dispatch, (...) Without

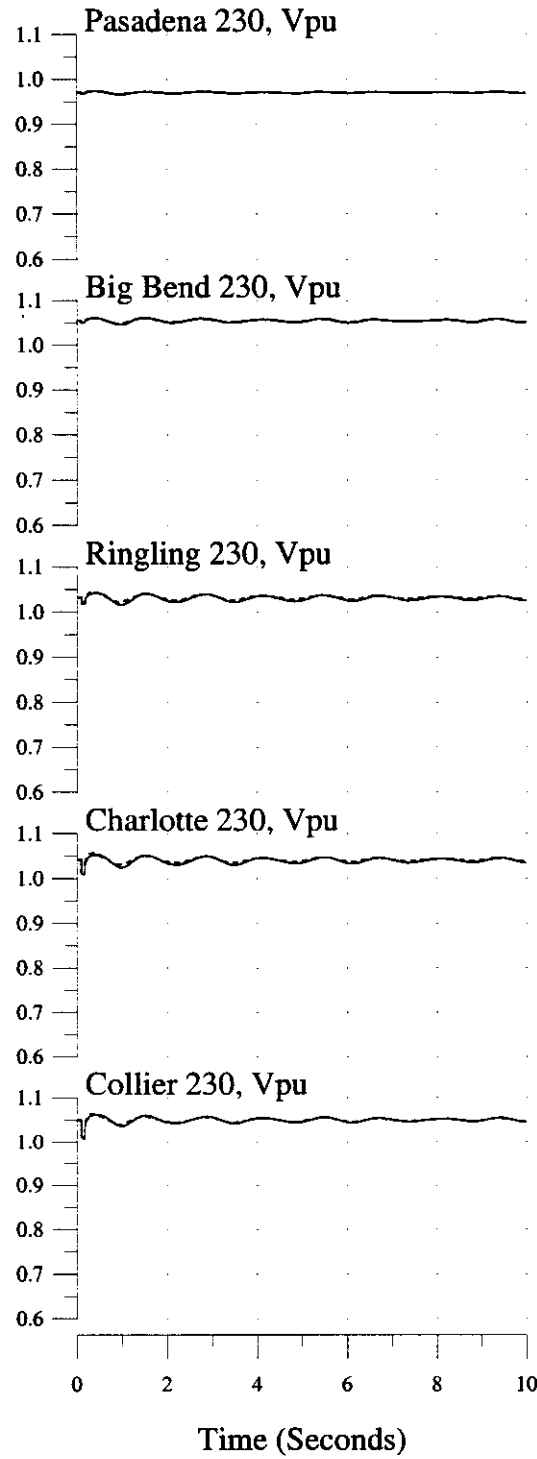
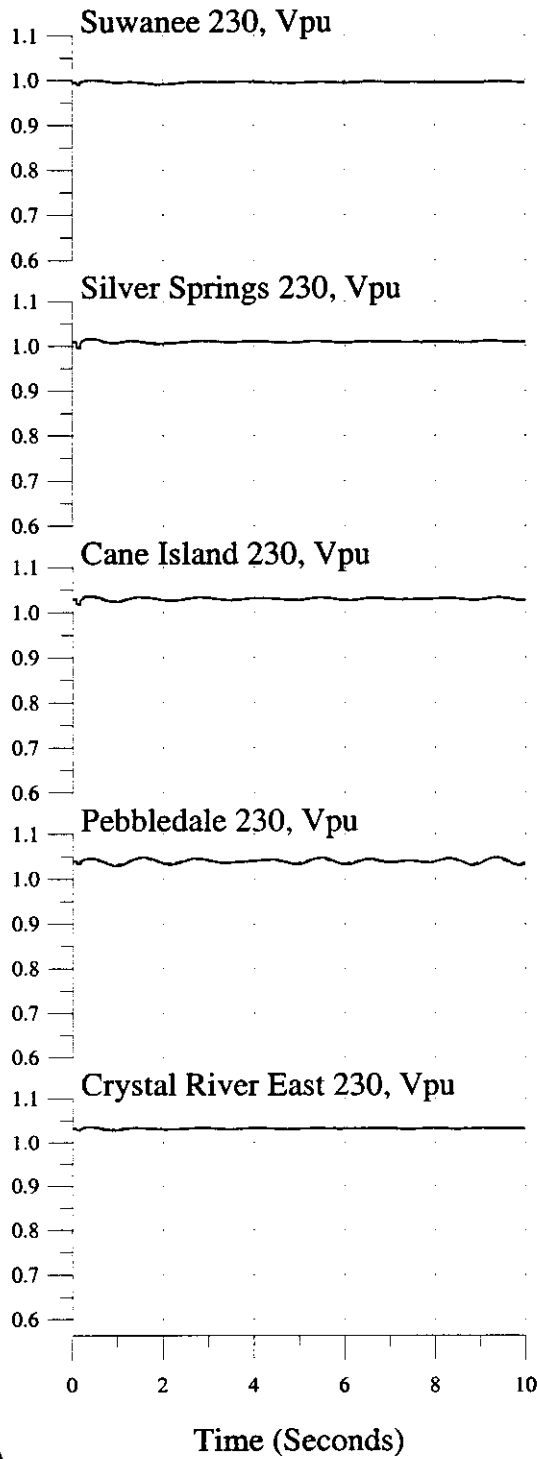

3-ph, 5-cy Fault at Martin 500kV Bus, Trip Martin #2 & GSU, TT Martin-Poinsett 500kV Line
2003 Summer System

Machine & Interface Variables: (___) With Okeechobee So. FPL Dispatch, (...) Without

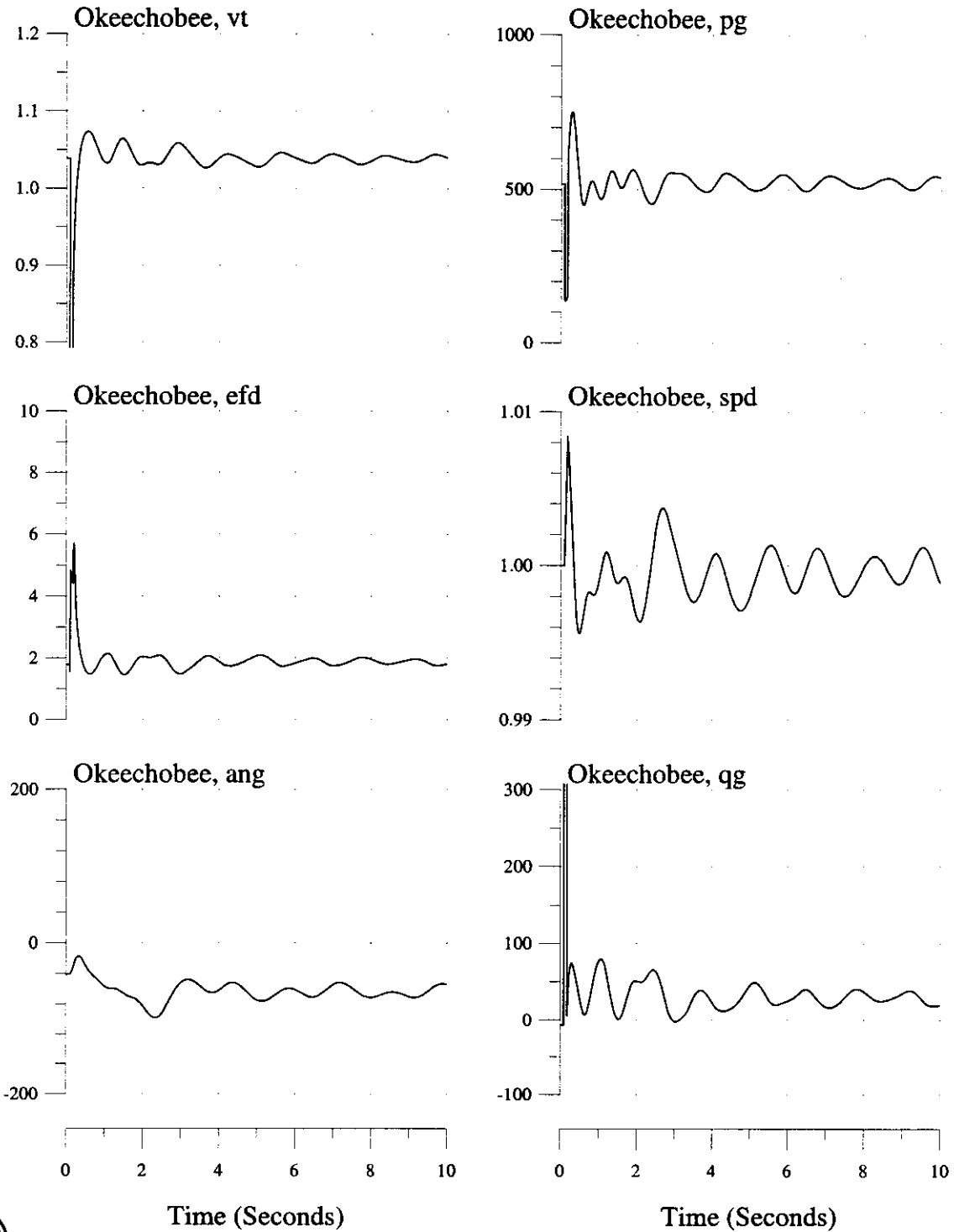

3-ph, 5-cy Fault at Martin 500kV Bus, Trip Martin #2 & GSU, TT Martin-Poinsett 500kV Line 2003 Summer System

Machine & Interface Variables: (—) With Okeechobee So. FPL Dispatch, (...) Without

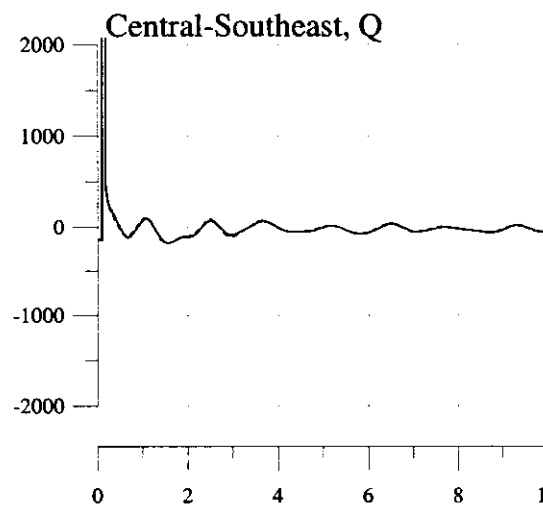
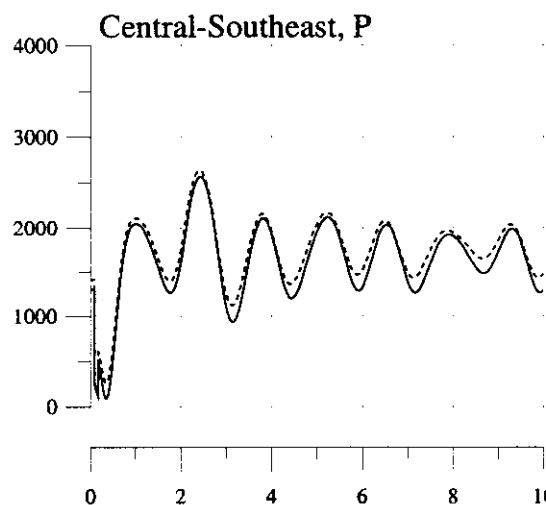
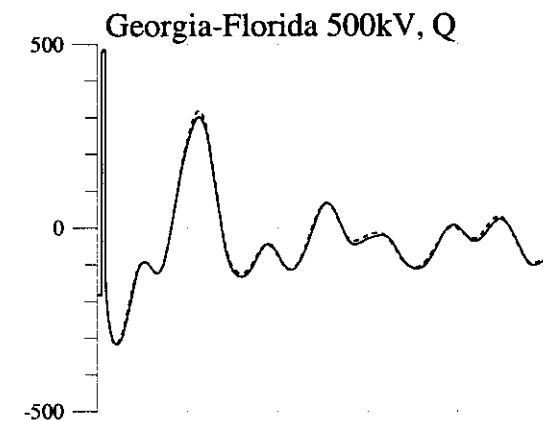
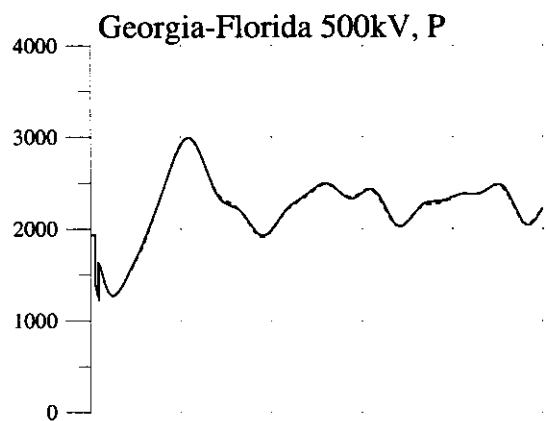
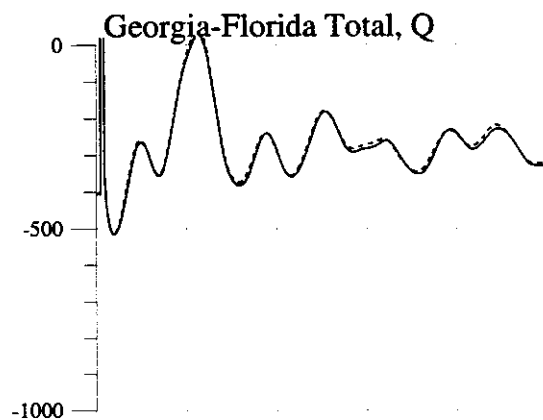
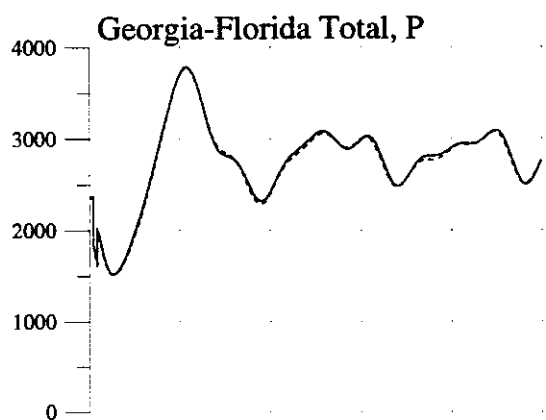

Time (Seconds)

Time (Seconds)



3-ph, 5-cy Fault at Martin 500kV Bus, Trip Martin #2 & GSU, TT Martin-Poinsett 500kV Line
 2003 Summer System

Machine Variables: (—) With Okeechobee So. FPL Dispatch, (...) Without

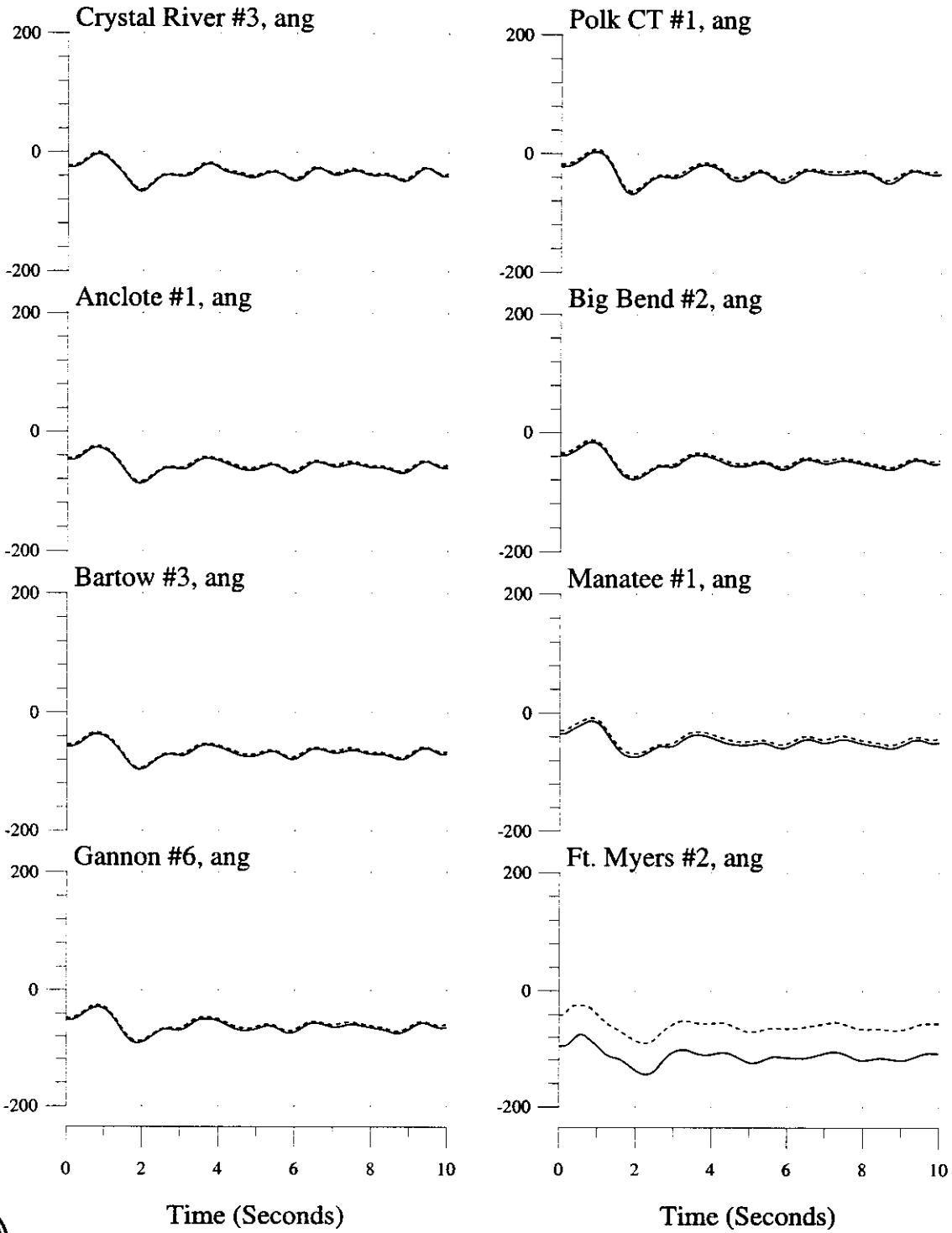

3-ph, 5-cy Fault at Martin 500kV Bus, Trip Martin #2 & GSU, TT Martin-Poinsett 500kV Line
 2003 Summer System

Machine Variables: (___) With Okeechobee So. FPL Dispatch, (...) Without

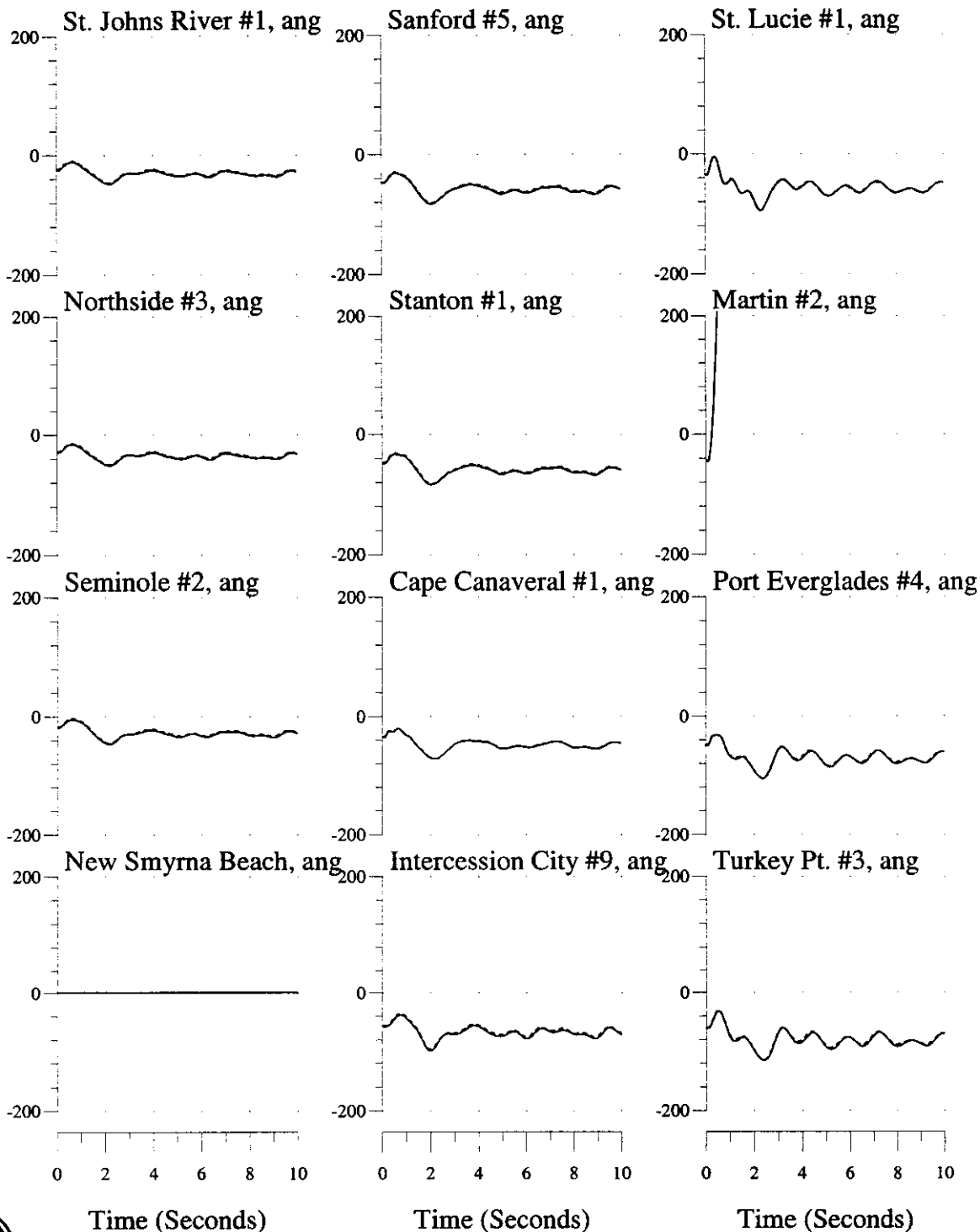

3-ph, 5-cy Fault at Martin 500kV Bus, Trip Martin #2 & GSU, TT Martin-Poinsett 500kV Line
2003 Summer System

Bus Variables: (___) With Okeechobee So. FPL Dispatch, (...) Without

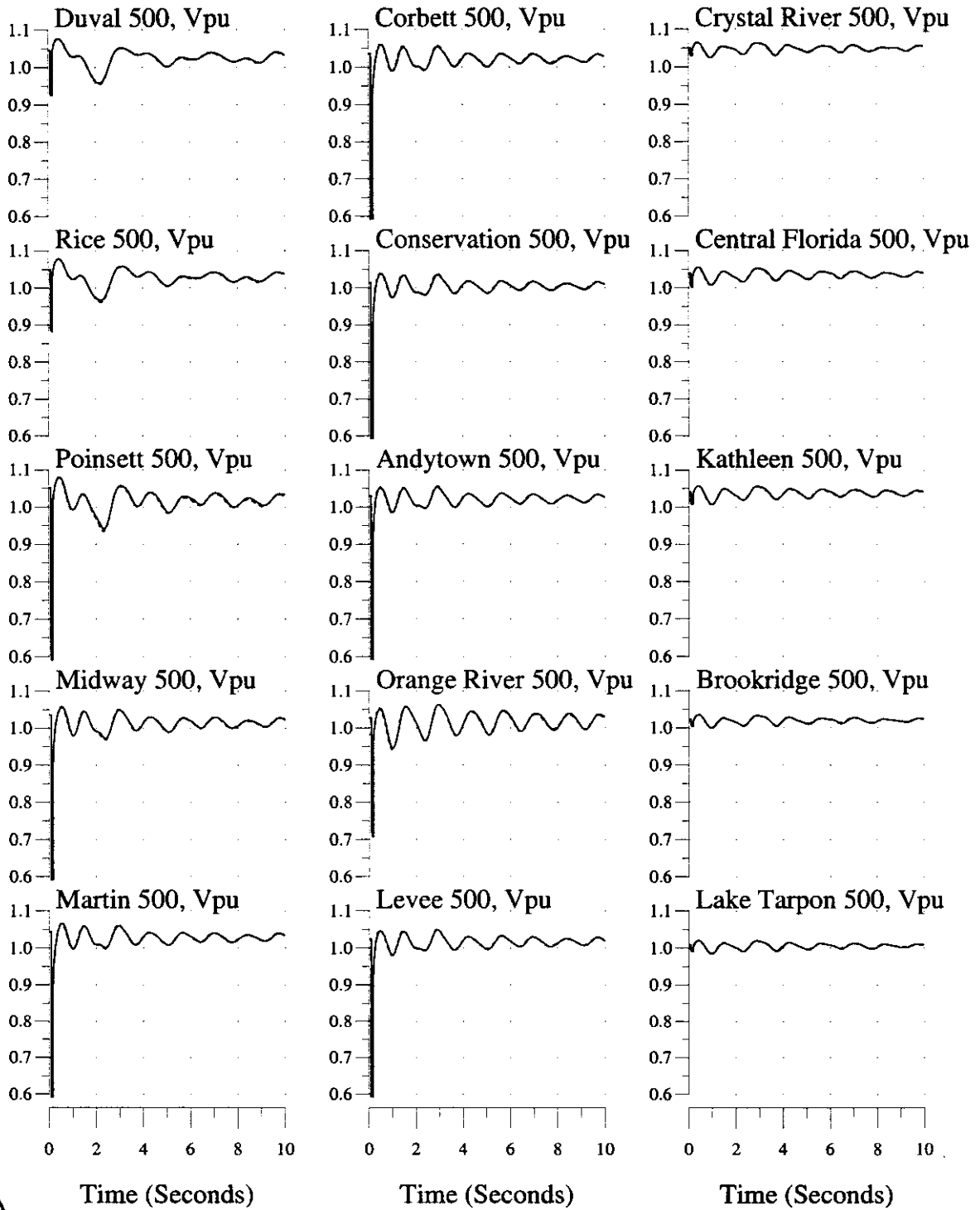

3-ph, 5-cy Fault at Martin 500kV Bus, Trip Martin #2 & GSU, TT Martin-Poinsett 500kV Line
2003 Summer System

Bus Variables: (—) With Okeechobee So. FPL Dispatch, (...) Without

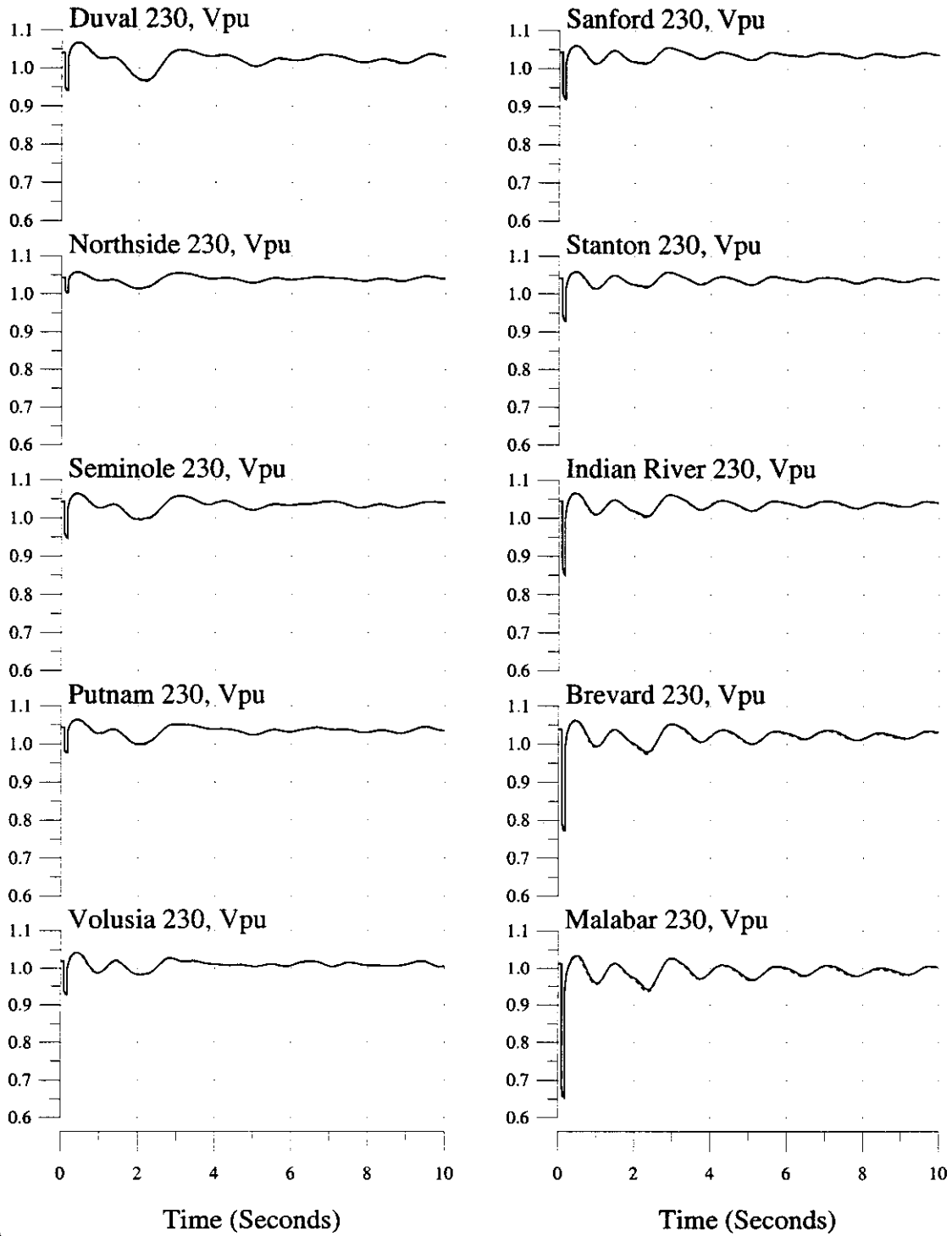

3-ph, 5-cy Fault at Martin 500kV Bus, Trip Martin #2 & GSU, TT Martin-Poinsett 500kV Line
2003 Summer System

Bus Variables: (—) With Okeechobee So. FPL Dispatch, (...) Without

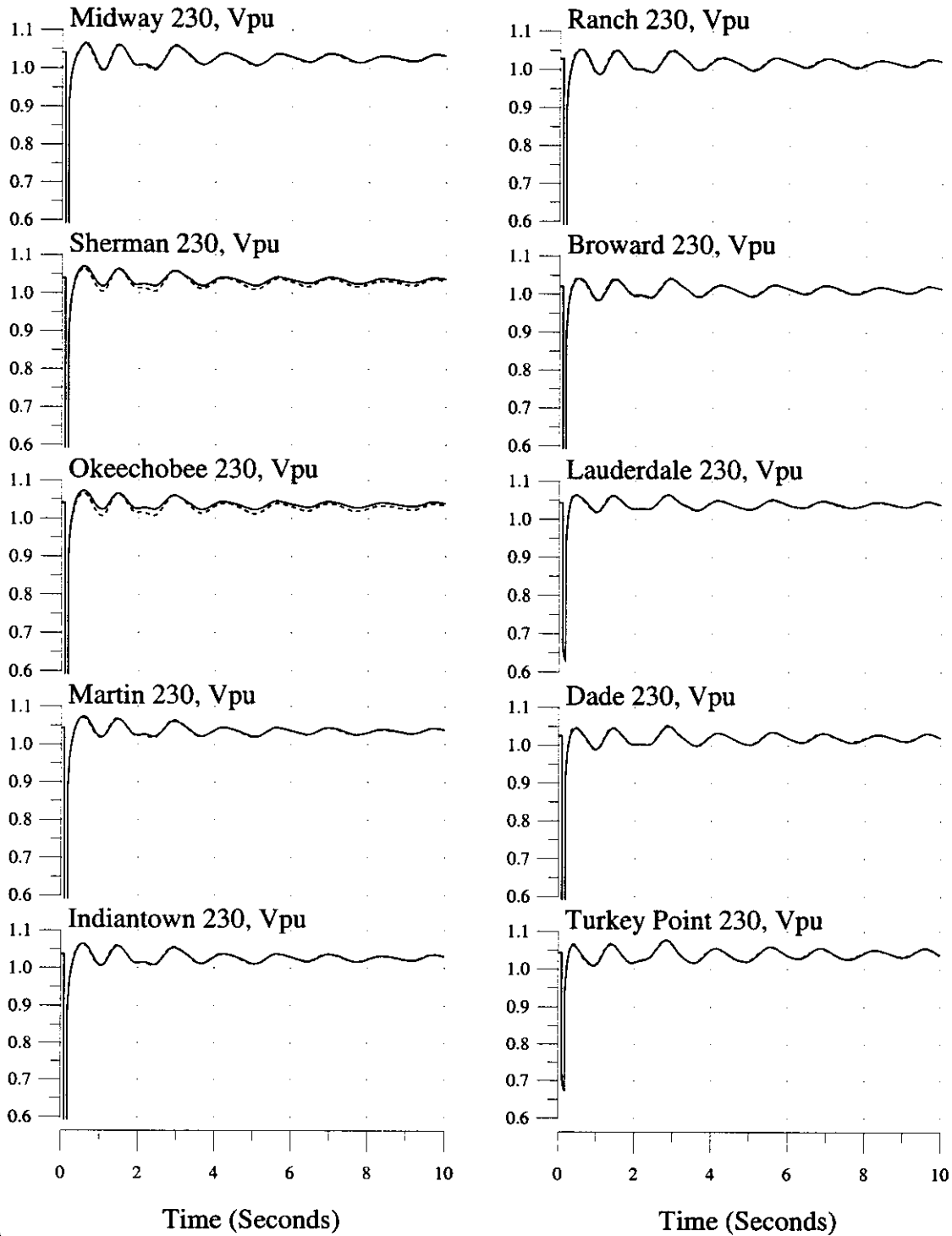

3-ph, 5-cy Fault at Martin 500kV Bus, Trip Martin #2 & GSU, TT Martin-Poinsett 500kV Line
 2003 Summer System

Bus Variables: (___) With Okeechobee So. FPL Dispatch, (...) Without

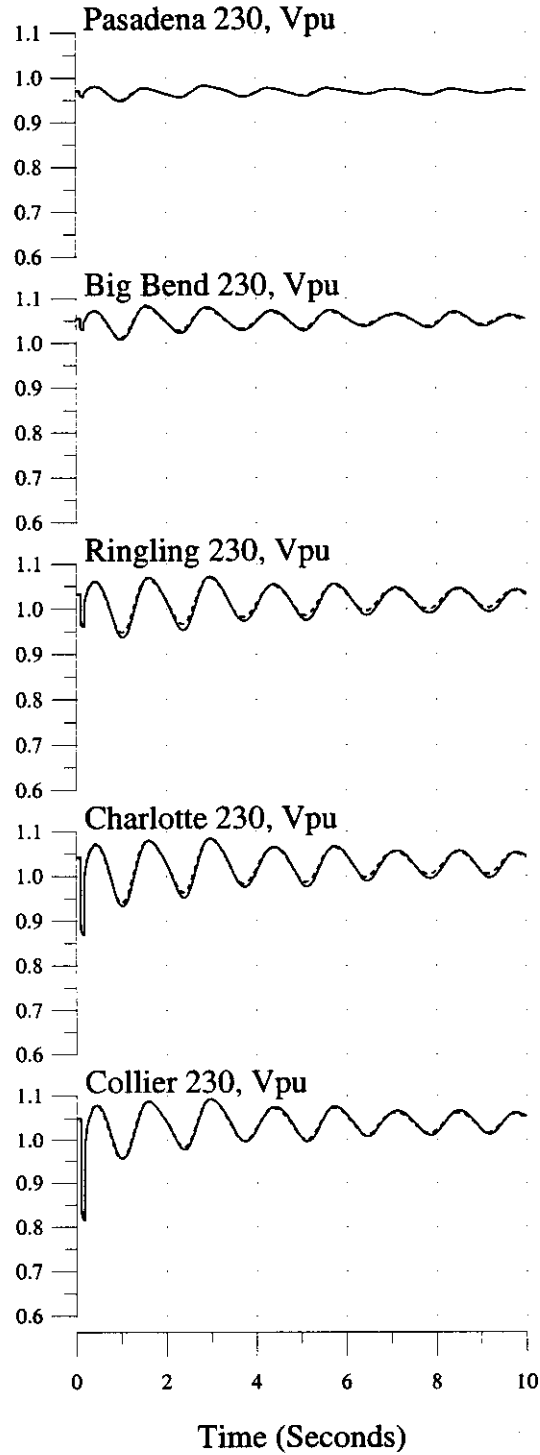
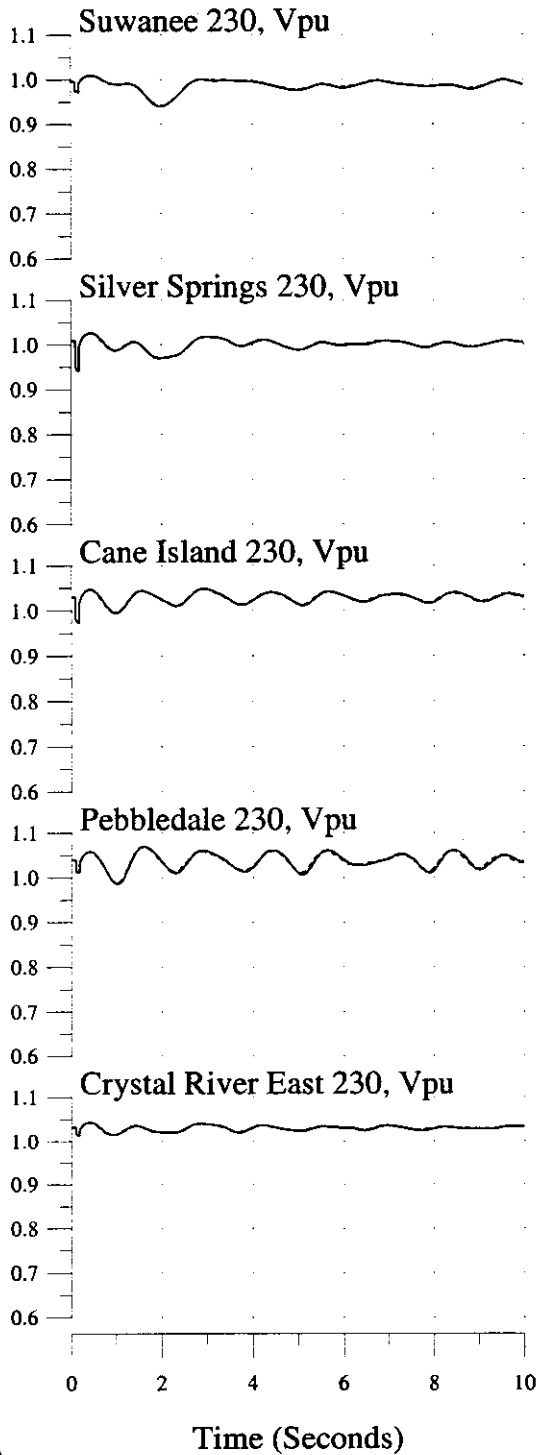

3-ph Fault at Turkey Pt 230kV Bus, Trip TP #3 & GSU @5-cy, Trip TP-Galloway 230kV Line @12cy
2003 Summer System

Machine & Interface Variables: (___) With Okeechobee So. FPL Dispatch, (...) Without

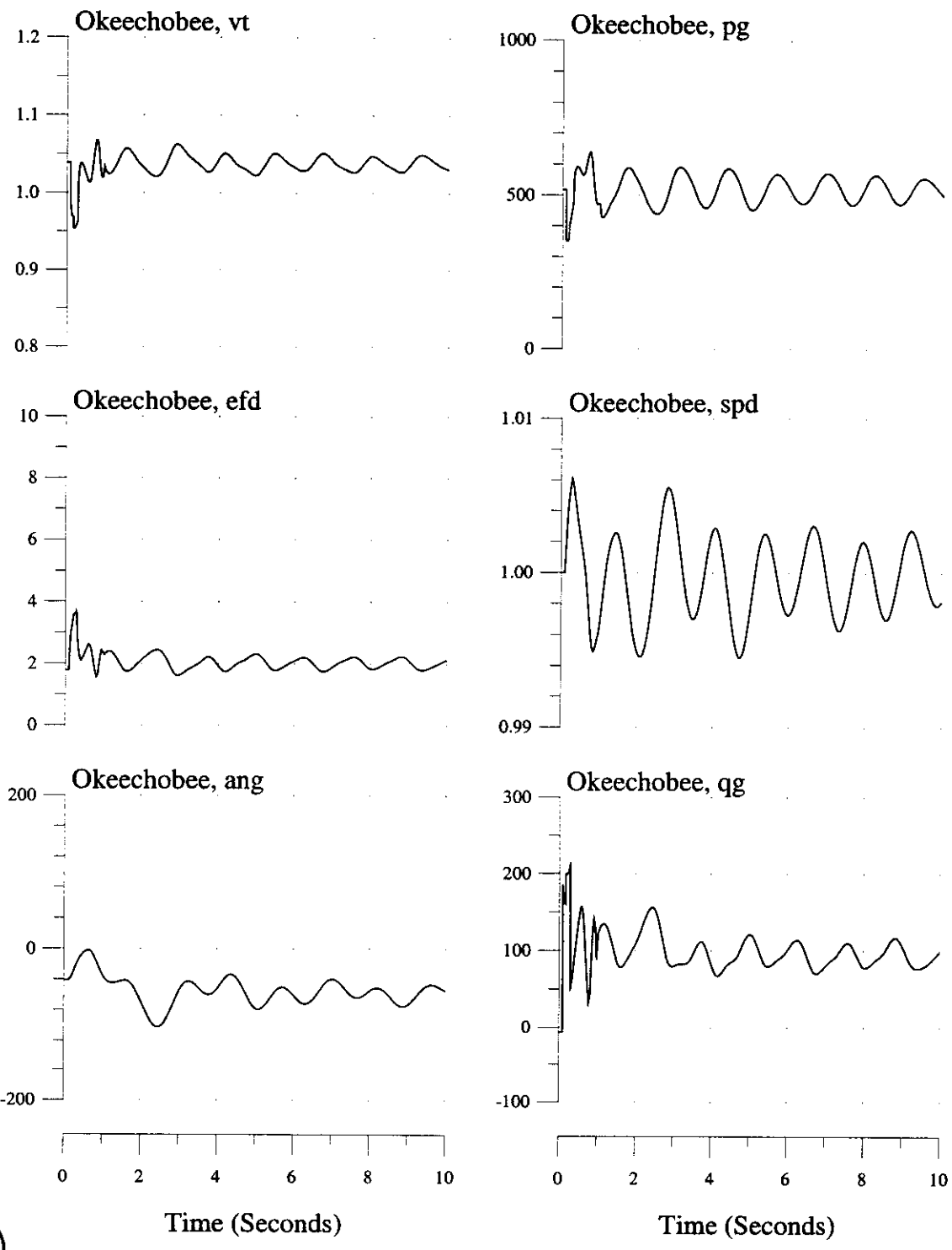

3-ph Fault at Turkey Pt 230kV Bus, Trip TP #3 & GSU @5-cy, Trip TP-Galloway 230kV Line @12cy
2003 Summer System

Machine & Interface Variables: (—) With Okeechobee So. FPL Dispatch, (...) Without

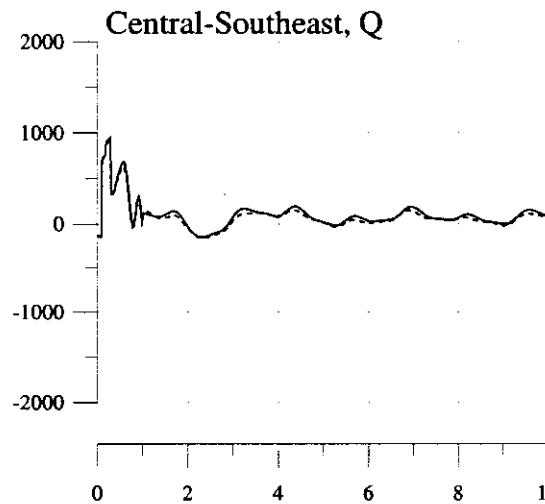
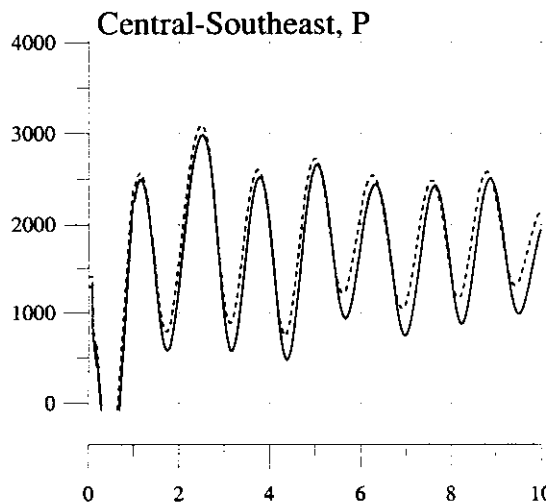
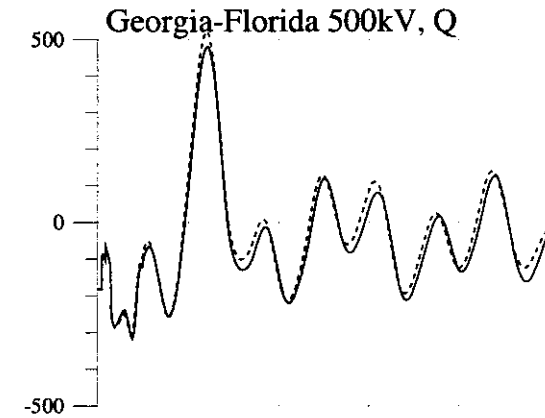
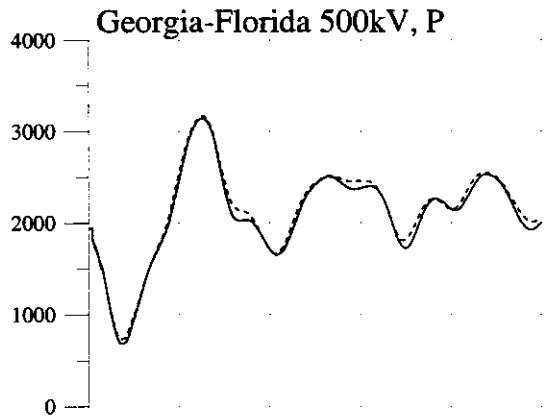
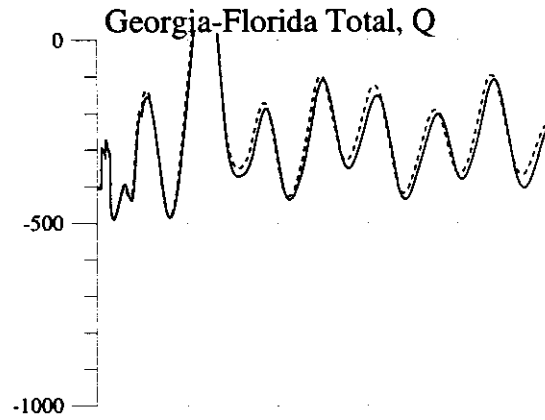
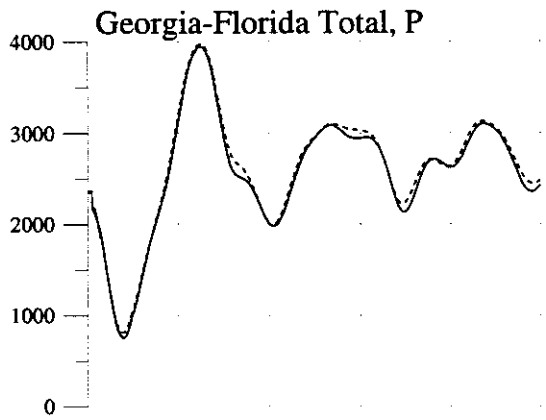

Time (Seconds)

Time (Seconds)



3-ph Fault at Turkey Pt 230kV Bus, Trip TP #3 & GSU @5-cy, Trip TP-Galloway 230kV Line @12cy
2003 Summer System

Machine Variables: (—) With Okeechobee So. FPL Dispatch, (...) Without

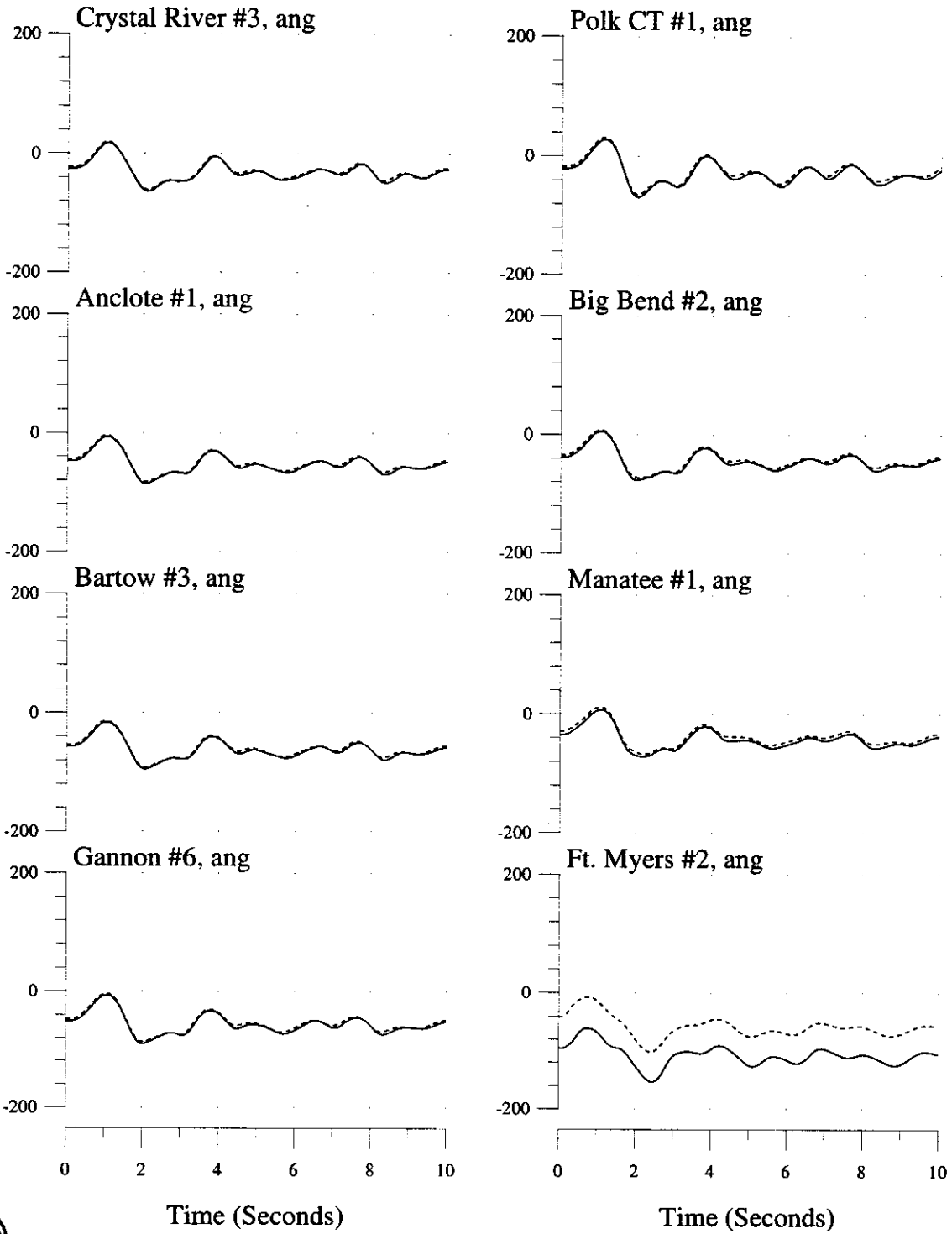

3-ph Fault at Turkey Pt 230kV Bus, Trip TP #3 & GSU @5-cy, Trip TP-Galloway 230kV Line @12cy
2003 Summer System

Machine Variables: (___) With Okeechobee So. FPL Dispatch, (...) Without

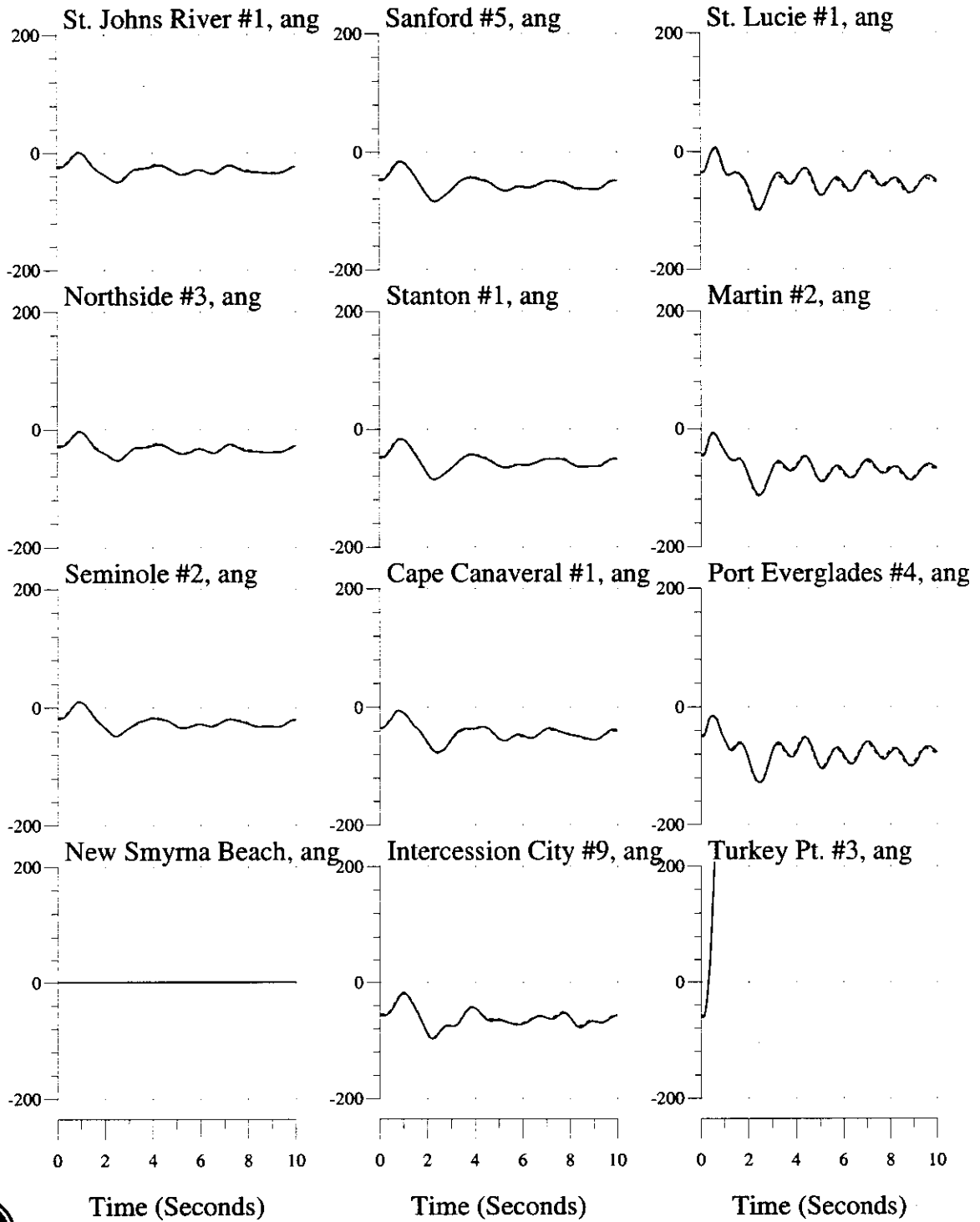

3-ph Fault at Turkey Pt 230kV Bus, Trip TP #3 & GSU @5-cy, Trip TP-Galloway 230kV Line @12cy
 2003 Summer System

Bus Variables: (___) With Okeechobee So. FPL Dispatch, (...) Without

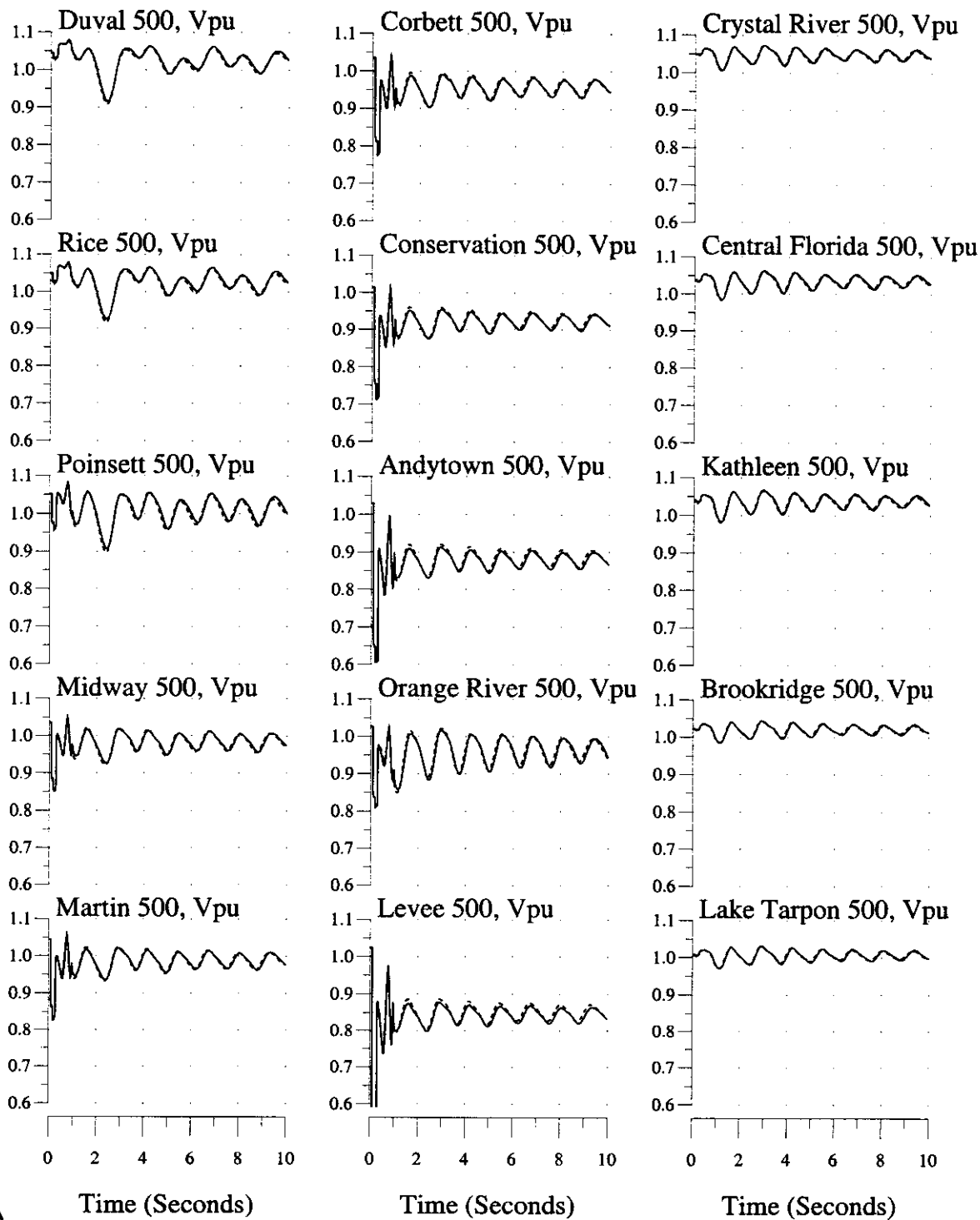

3-ph Fault at Turkey Pt 230kV Bus, Trip TP #3 & GSU @5-cy, Trip TP-Galloway 230kV Line @12cy
2003 Summer System

Bus Variables: (___) With Okeechobee So. FPL Dispatch, (...) Without

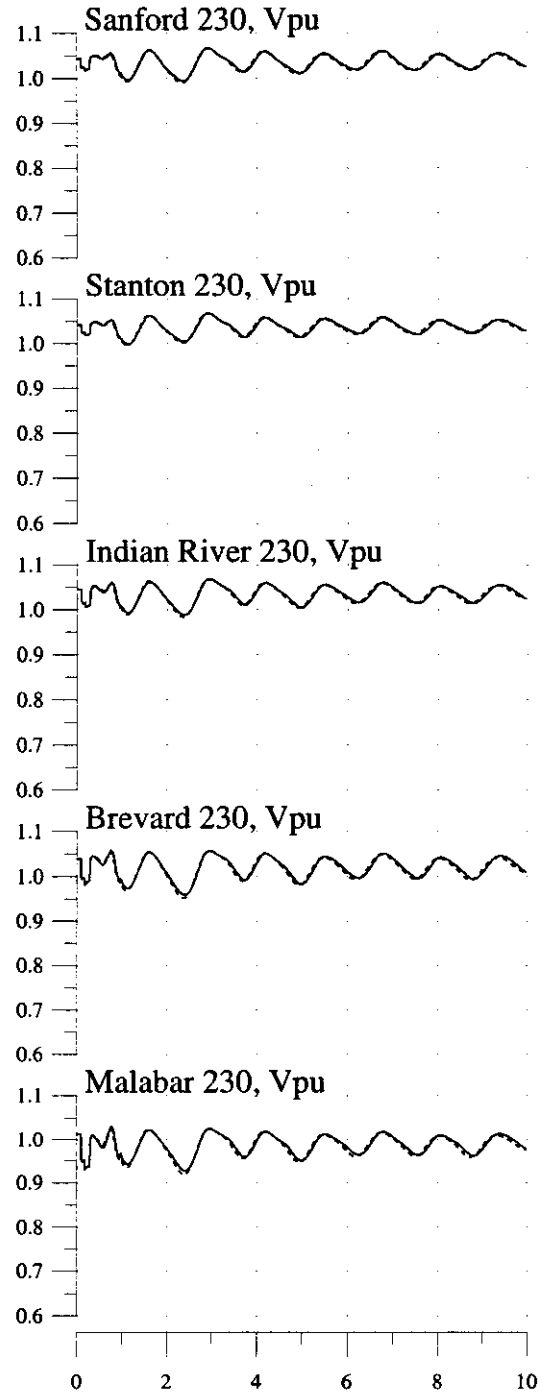
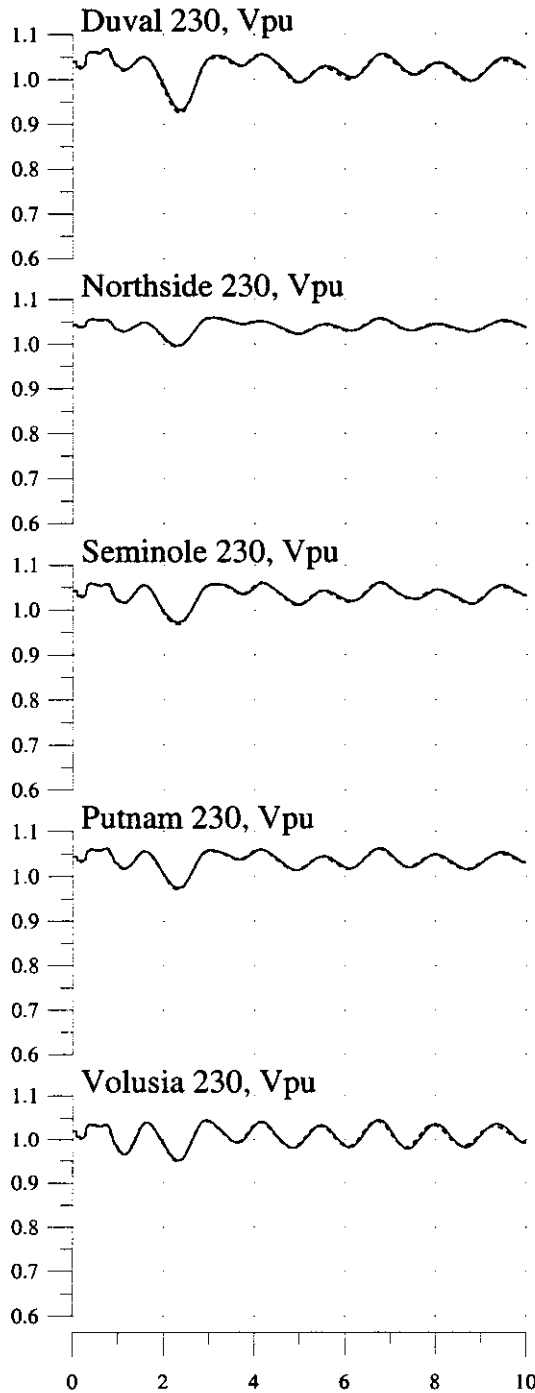

3-ph Fault at Turkey Pt 230kV Bus, Trip TP #3 & GSU @5-cy, Trip TP-Galloway 230kV Line @12cy
2003 Summer System

Bus Variables: (—) With Okeechobee So. FPL Dispatch, (...) Without

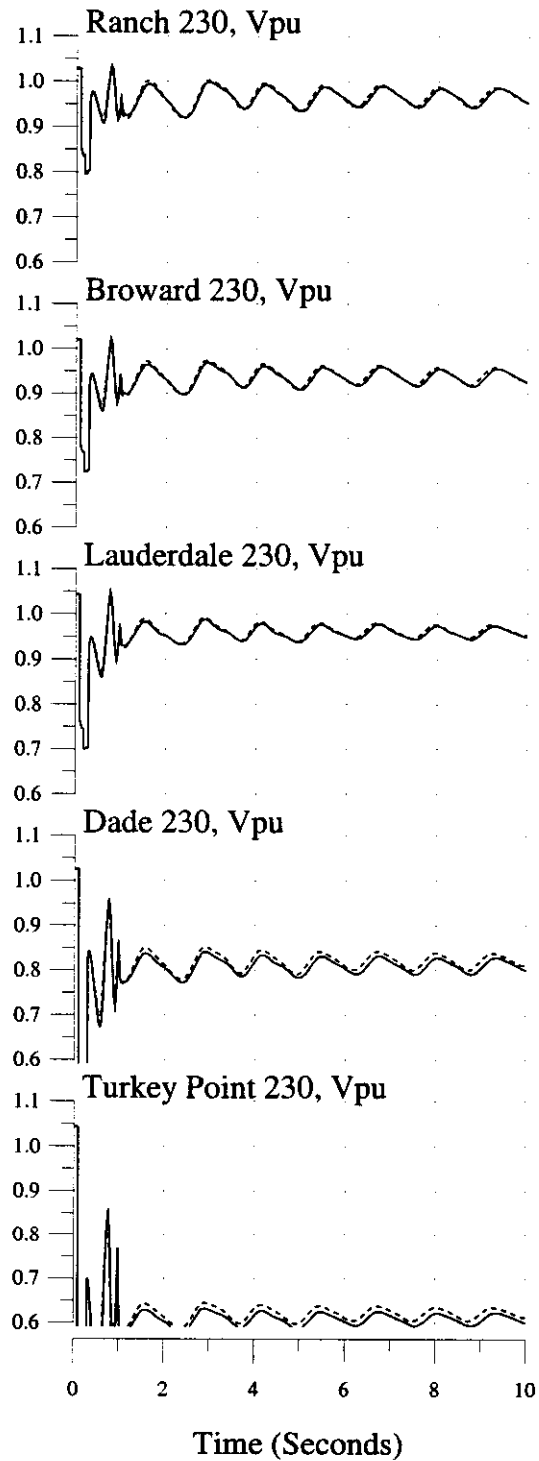
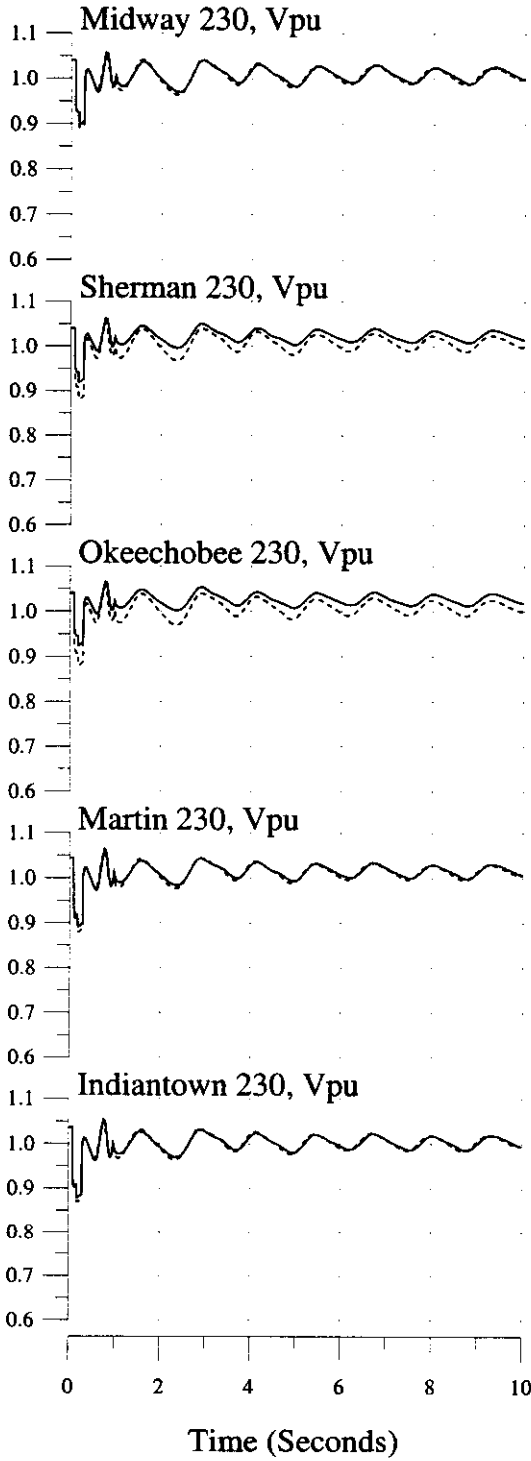

3-ph Fault at Turkey Pt 230kV Bus, Trip TP #3 & GSU @5-cy, Trip TP-Galloway 230kV Line @12cy 2003 Summer System

Bus Variables: (—) With Okeechobee So. FPL Dispatch, (...) Without

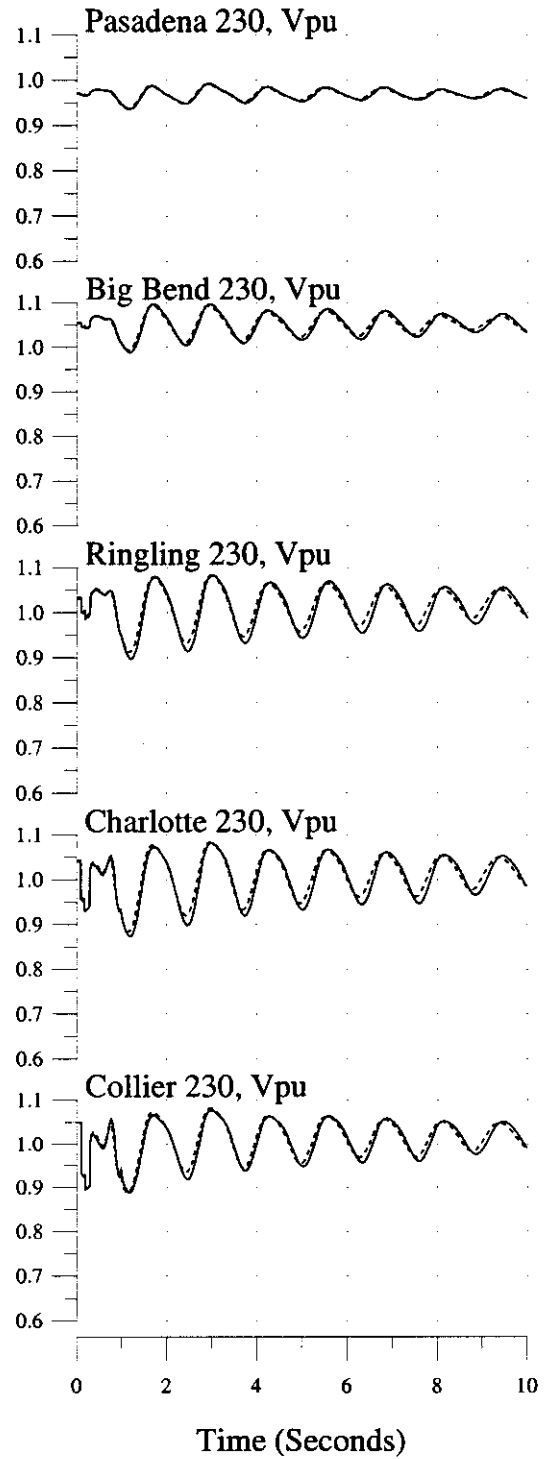
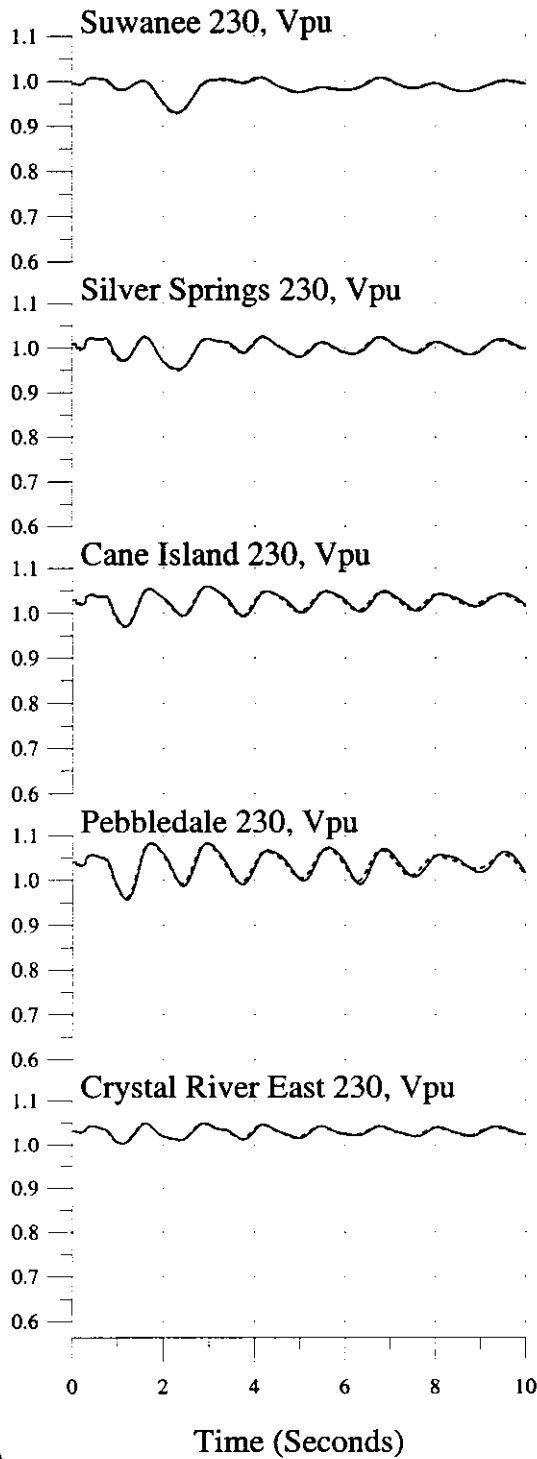

3-phase, 5-cycle Fault at St. Lucie 230kV Bus, Trip St. Lucie #1 & GSU
2003 Summer System

Machine & Interface Variables: (—) With Okeechobee No. FPL Dispatch, (...) Without

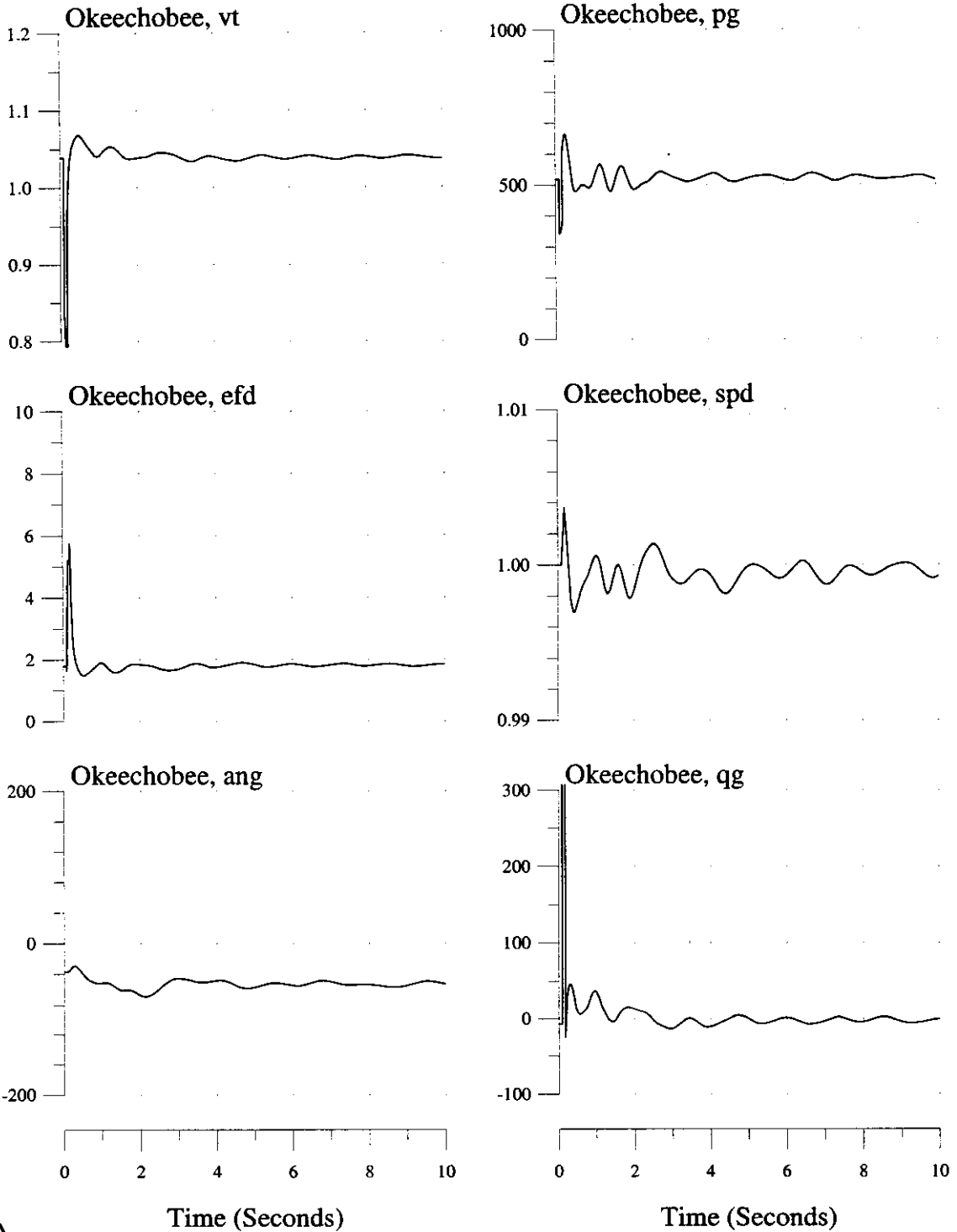

3-phase, 5-cycle Fault at St. Lucie 230kV Bus, Trip St. Lucie #1 & GSU
2003 Summer System

Machine & Interface Variables: (—) With Okeechobee No. FPL Dispatch, (...) Without

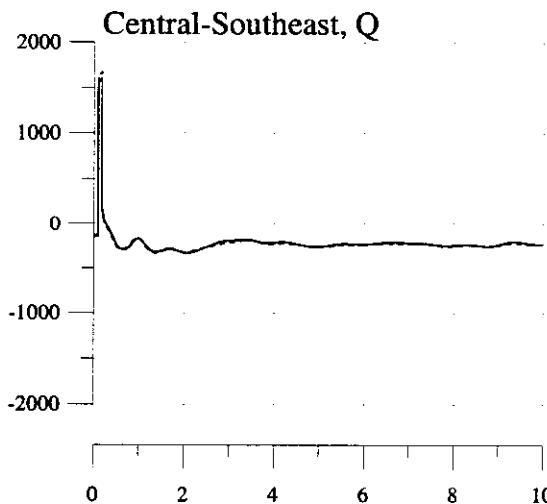
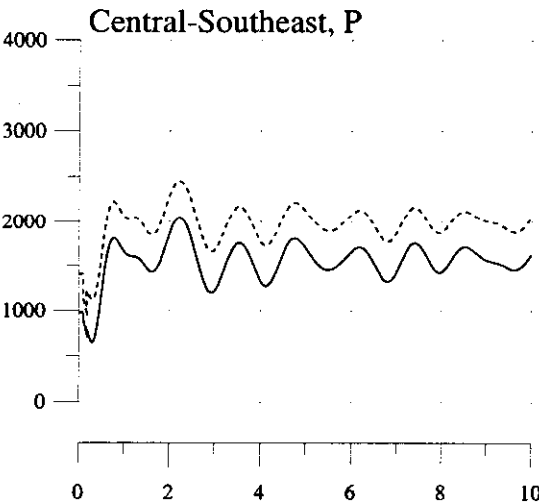
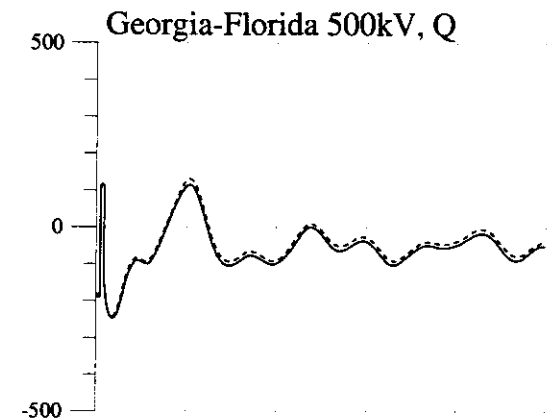
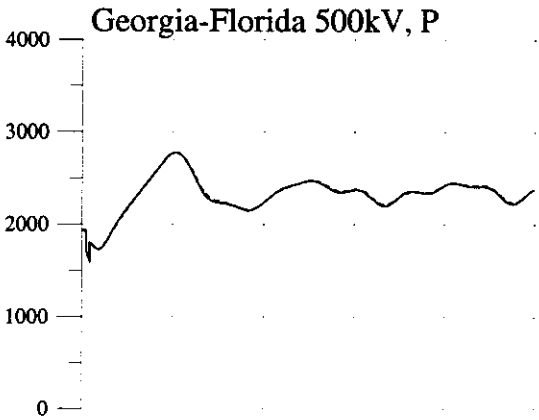
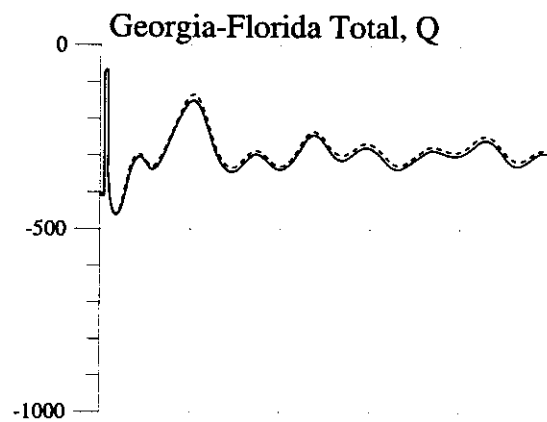
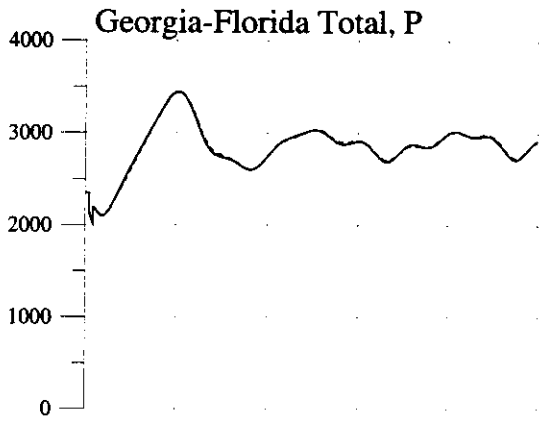

Time (Seconds)

Time (Seconds)



3-phase, 5-cycle Fault at St. Lucie 230kV Bus, Trip St. Lucie #1 & GSU
2003 Summer System

Machine Variables: (—) With Okeechobee No. FPL Dispatch, (...) Without

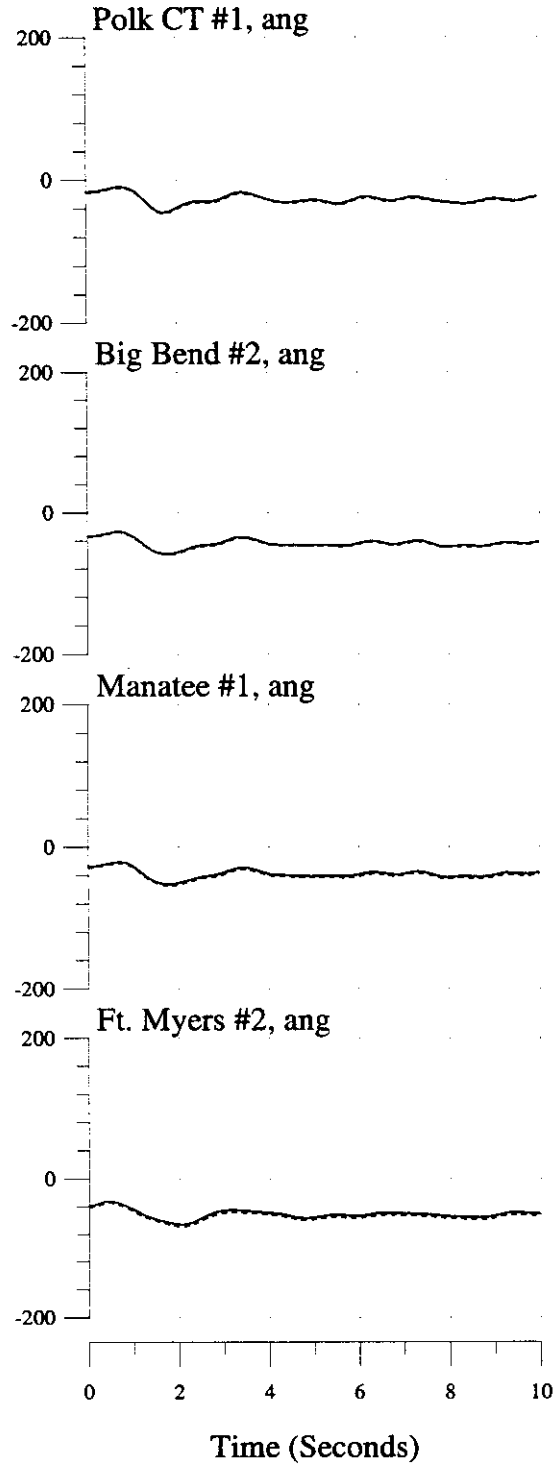
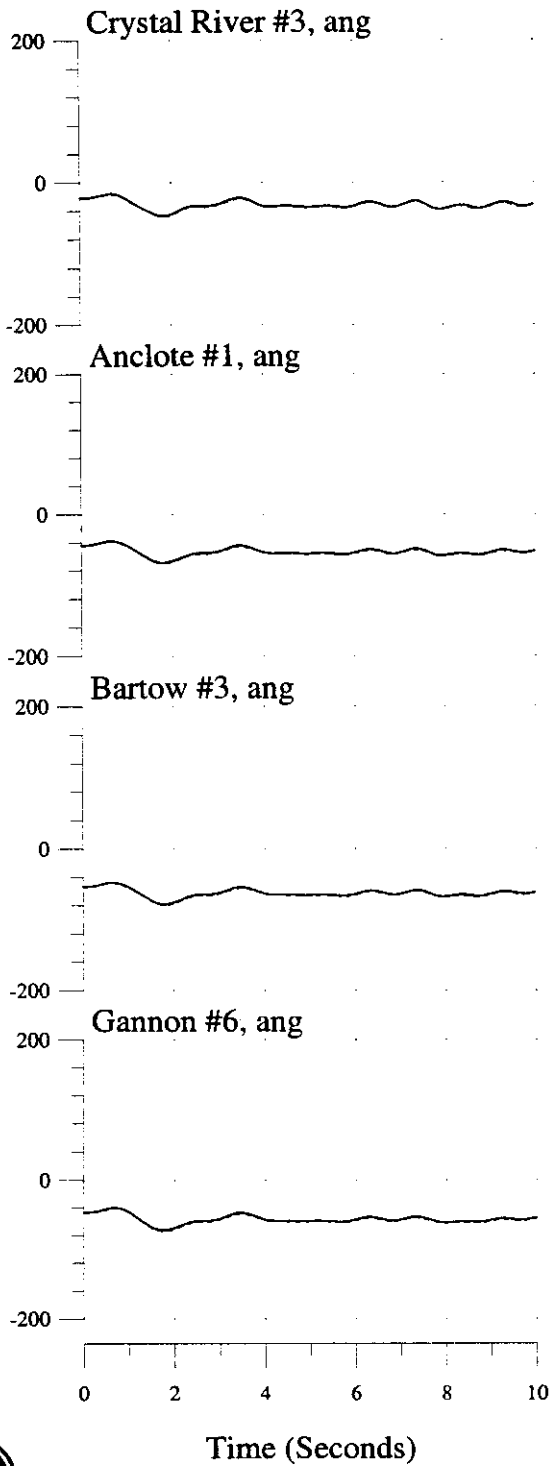

3-phase, 5-cycle Fault at St. Lucie 230kV Bus, Trip St. Lucie #1 & GSU
 2003 Summer System

Machine Variables: (___) With Okeechobee No. FPL Dispatch, (...) Without

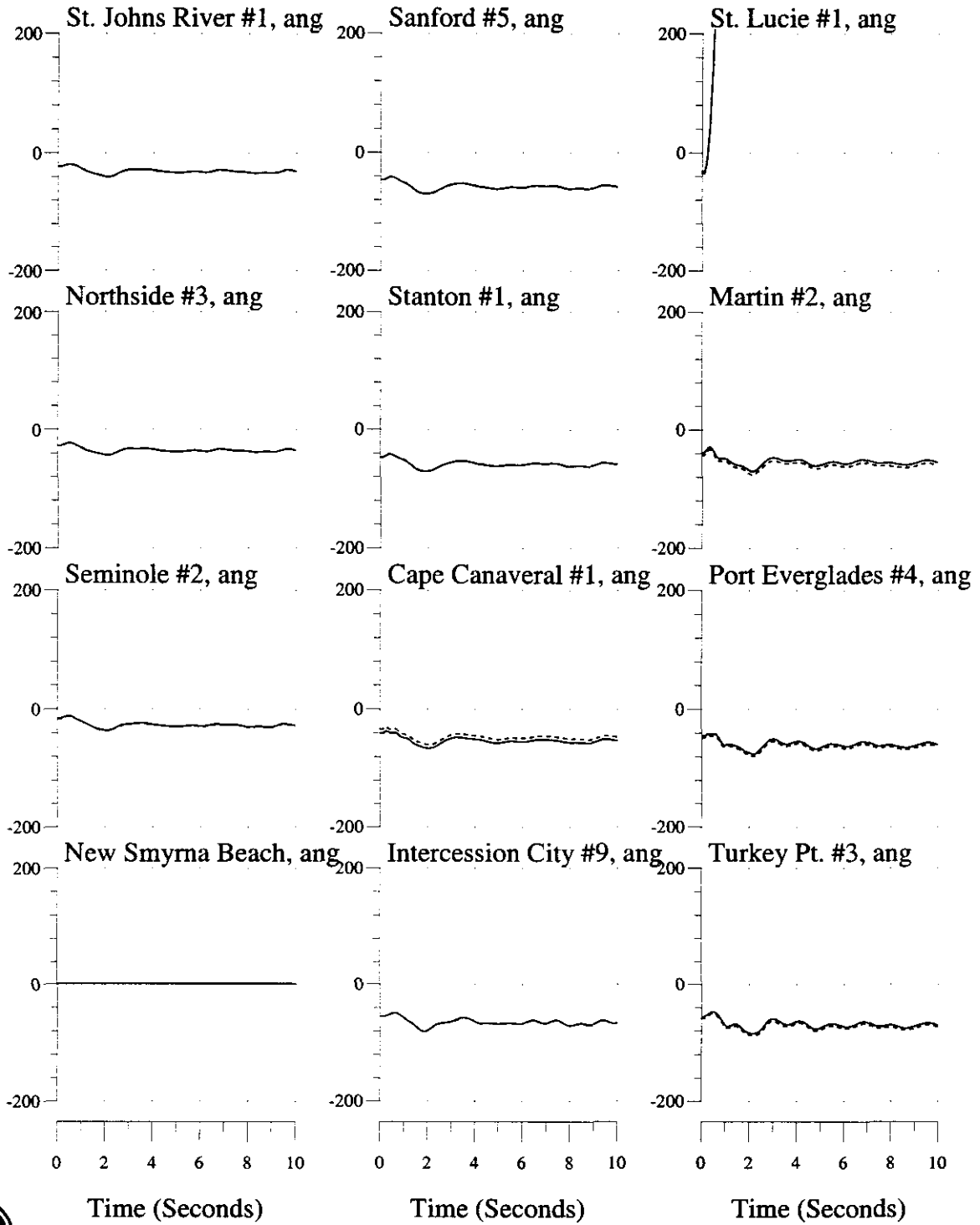

3-phase, 5-cycle Fault at St. Lucie 230kV Bus, Trip St. Lucie #1 & GSU
2003 Summer System

Bus Variables: (___) With Okeechobee No. FPL Dispatch, (...) Without

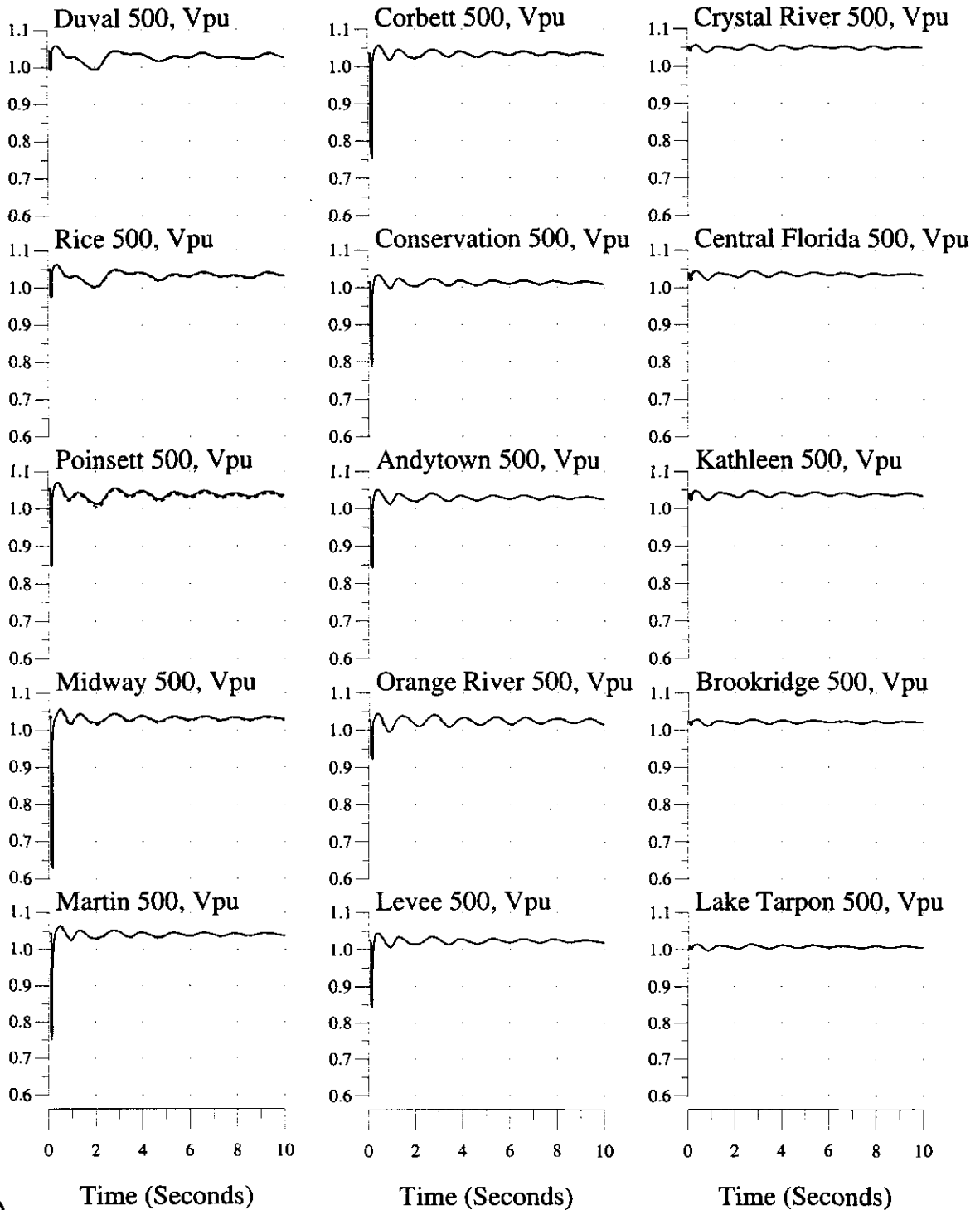

3-phase, 5-cycle Fault at St. Lucie 230kV Bus, Trip St. Lucie #1 & GSU
 2003 Summer System

Bus Variables: (___) With Okeechobee No. FPL Dispatch, (...) Without

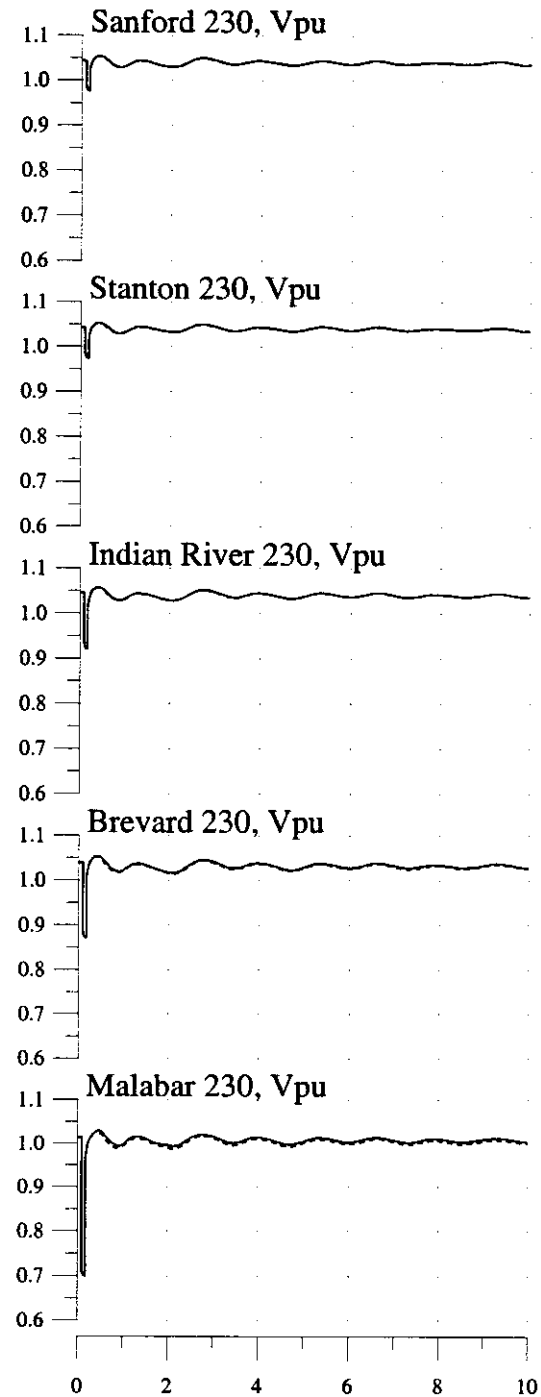
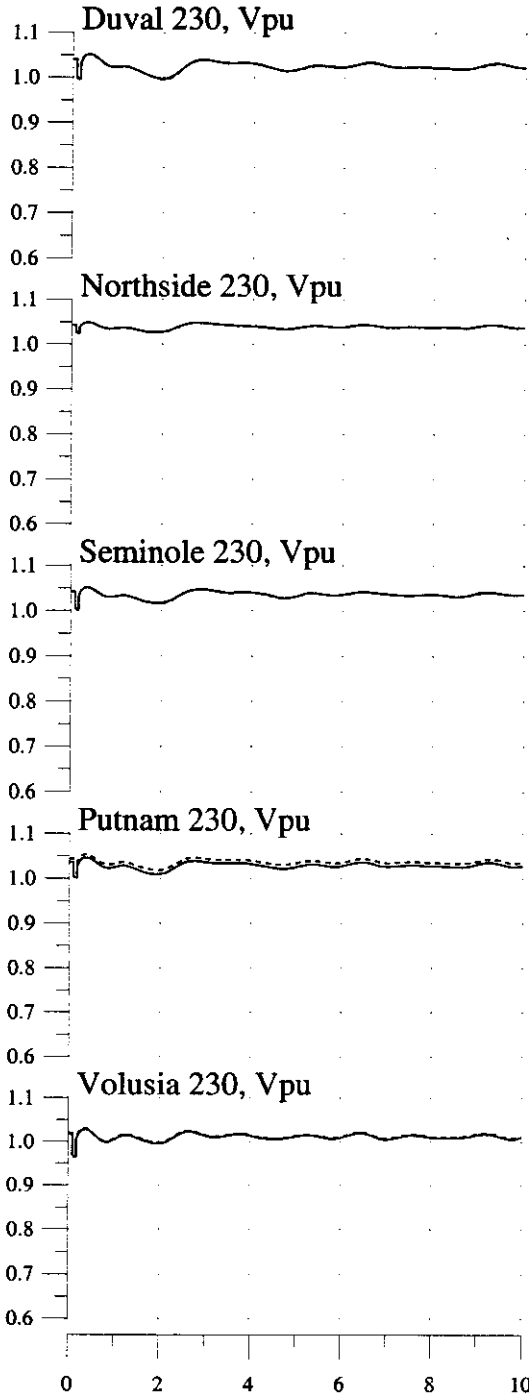

Time (Seconds)

Time (Seconds)



3-phase, 5-cycle Fault at St. Lucie 230kV Bus, Trip St. Lucie #1 & GSU 2003 Summer System

Bus Variables: (___) With Okeechobee No. FPL Dispatch, (...) Without

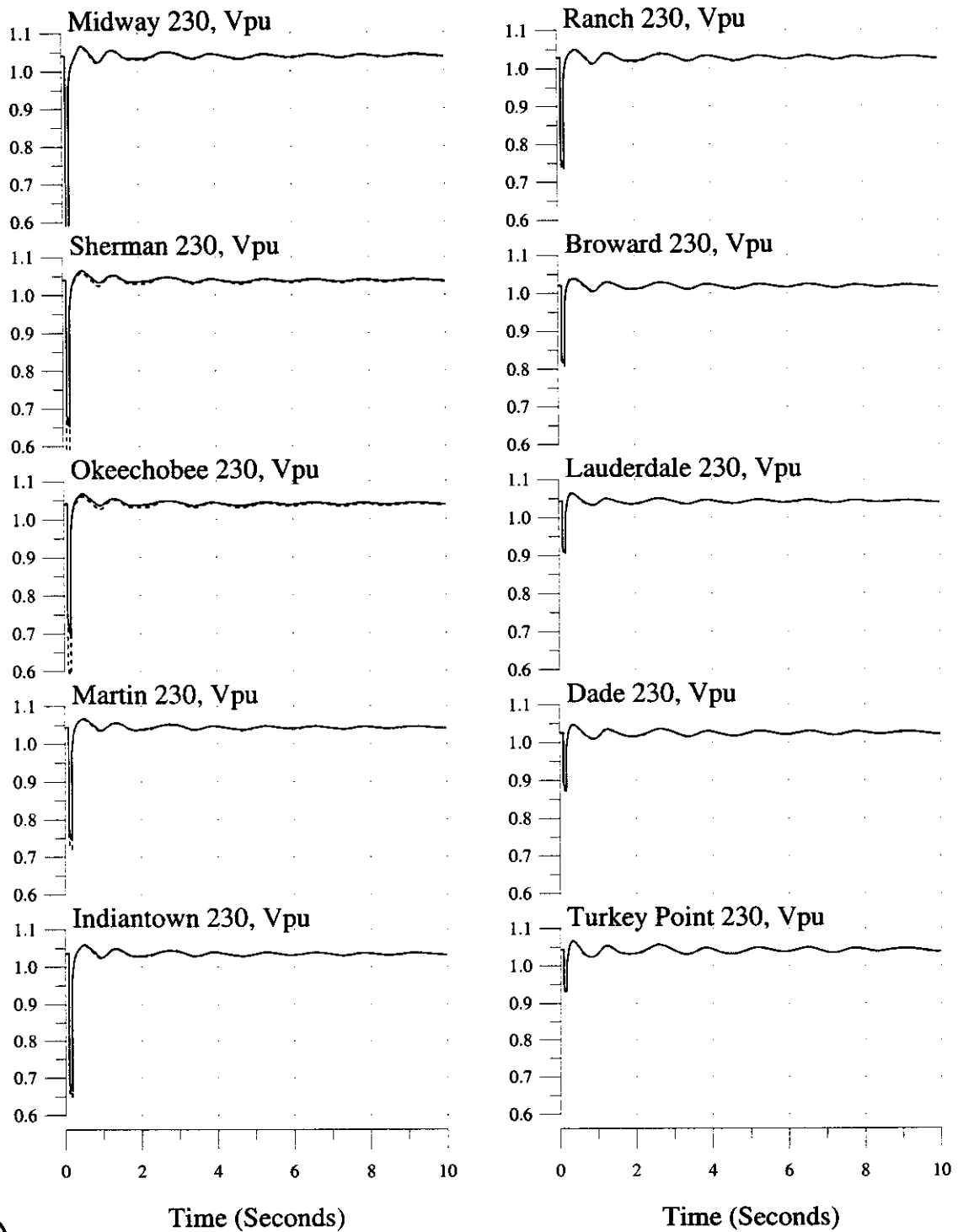

3-phase, 5-cycle Fault at St. Lucie 230kV Bus, Trip St. Lucie #1 & GSU
2003 Summer System

Bus Variables: (___) With Okeechobee No. FPL Dispatch, (...) Without

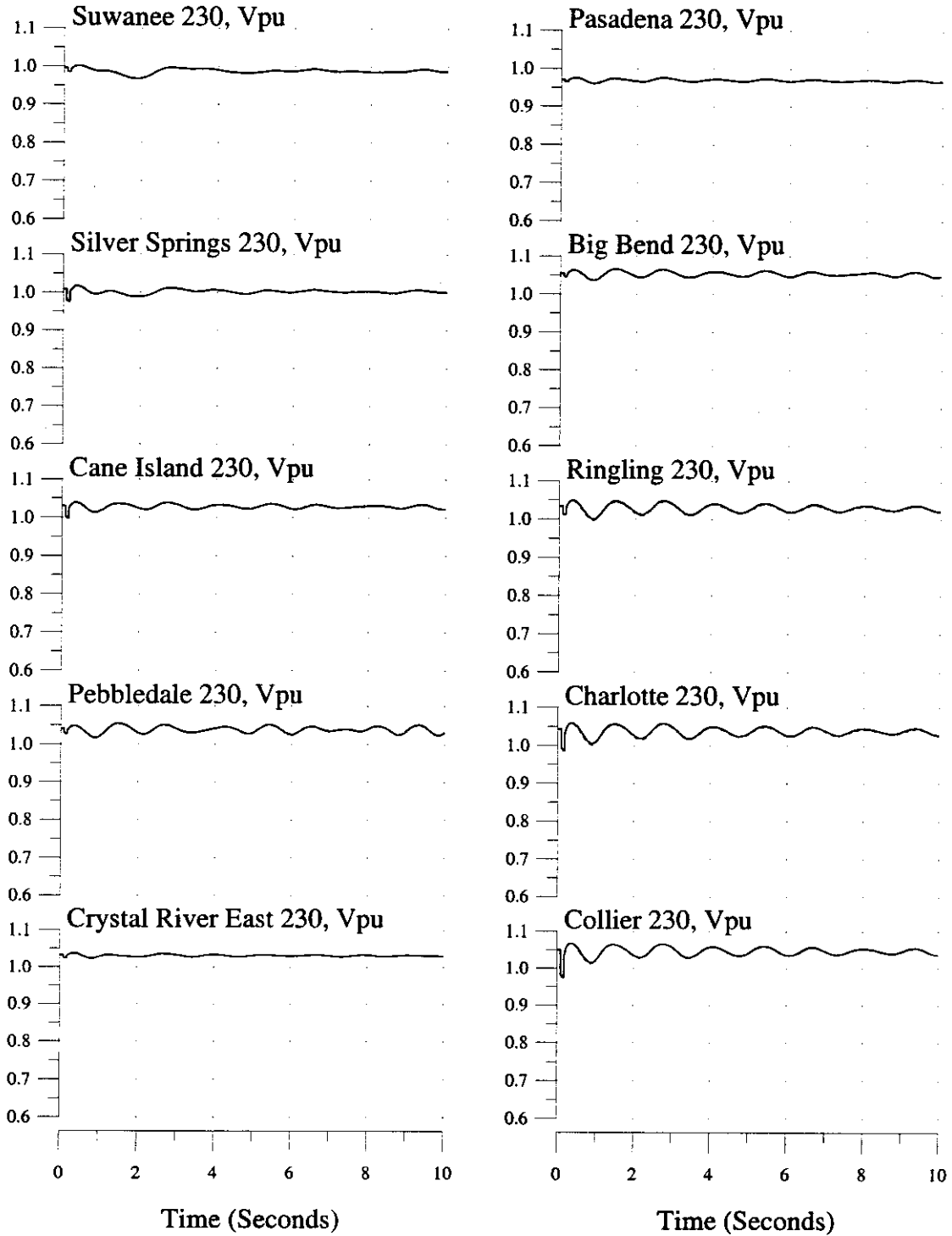

3-phase, 5-cycle Fault at Turkey Pt 230kV Bus, Trip Turkey Pt #3 & GSU
 2003 Summer System

Machine & Interface Variables: (—) With Okeechobee No. FPL Dispatch, (...) Without

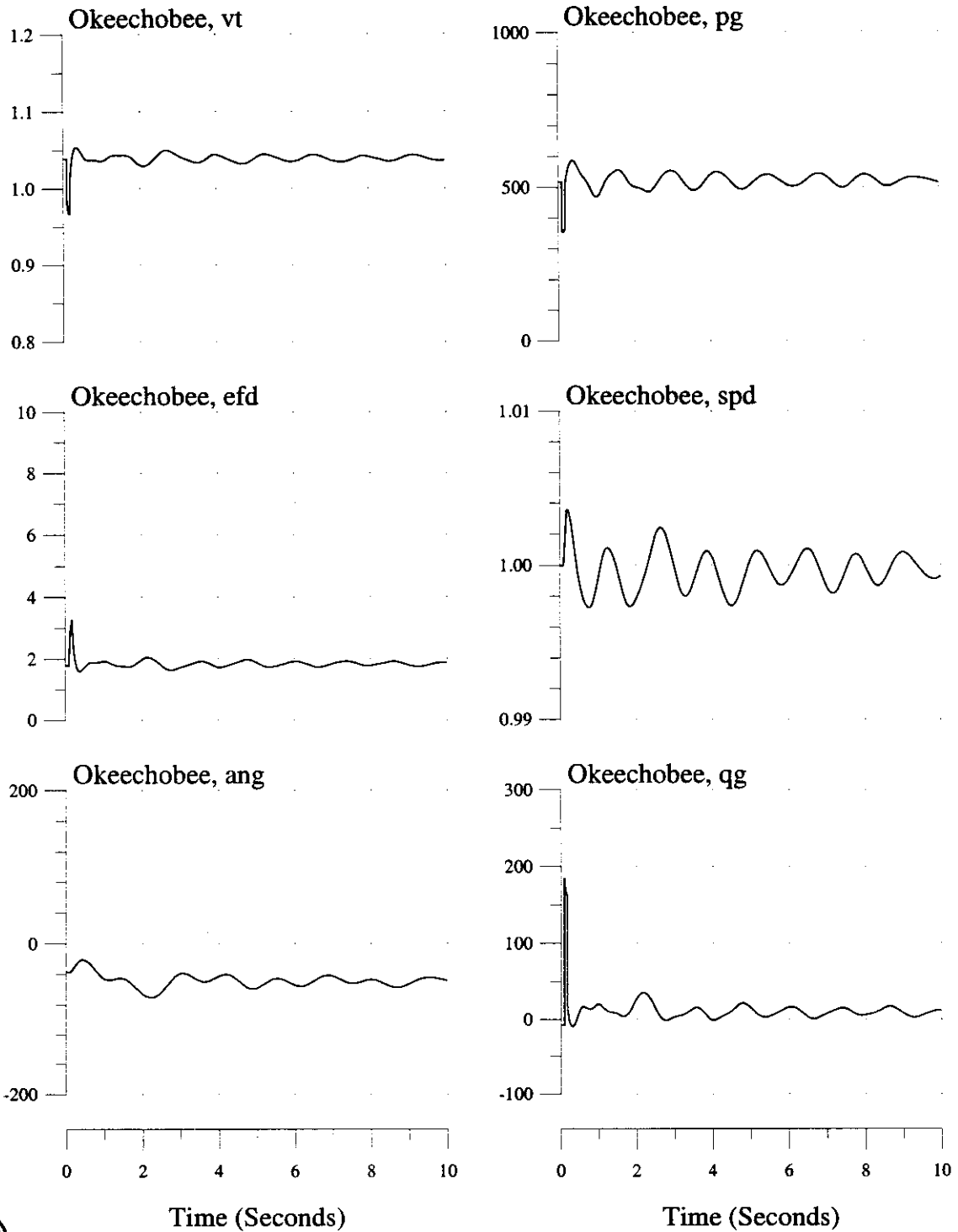

3-phase, 5-cycle Fault at Turkey Pt 230kV Bus, Trip Turkey Pt #3 & GSU
2003 Summer System

Machine & Interface Variables: (—) With Okeechobee No. FPL Dispatch, (...) Without

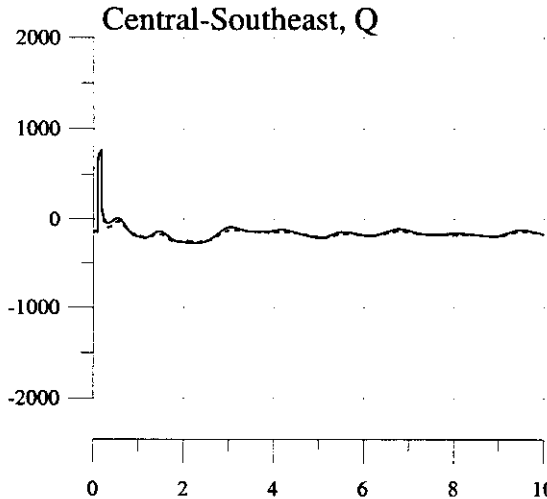
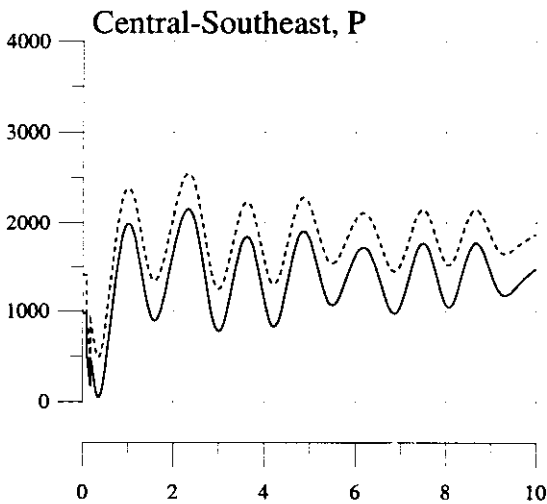
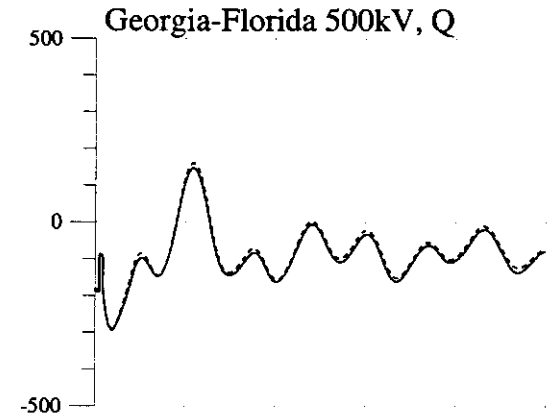
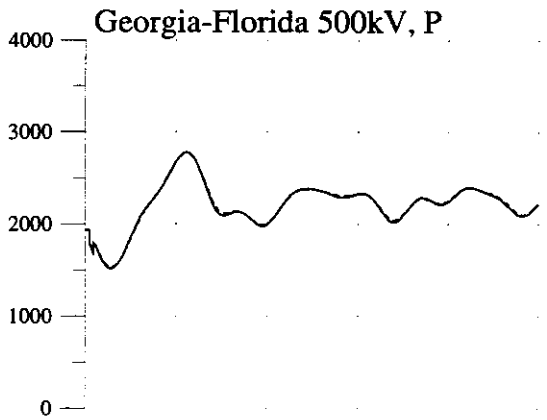
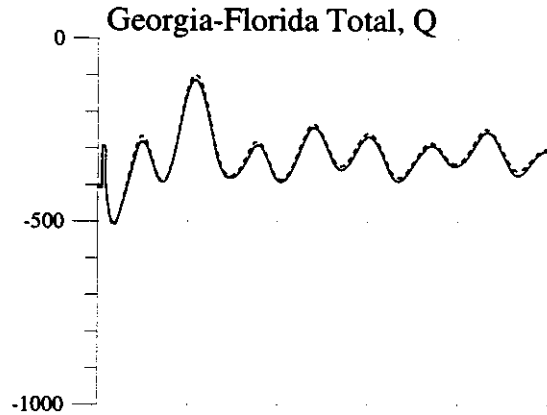
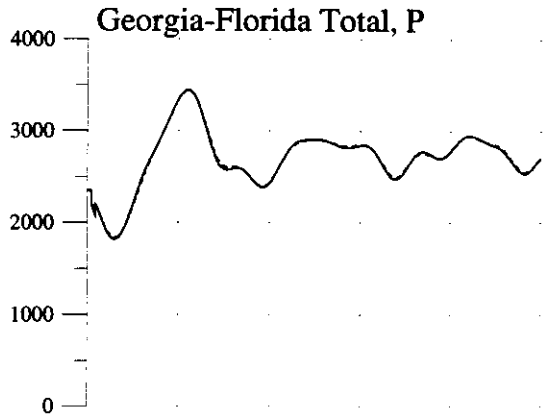

Time (Seconds)

Time (Seconds)



3-phase, 5-cycle Fault at Turkey Pt 230kV Bus, Trip Turkey Pt #3 & GSU
2003 Summer System

Machine Variables: (—) With Okeechobee No. FPL Dispatch, (...) Without

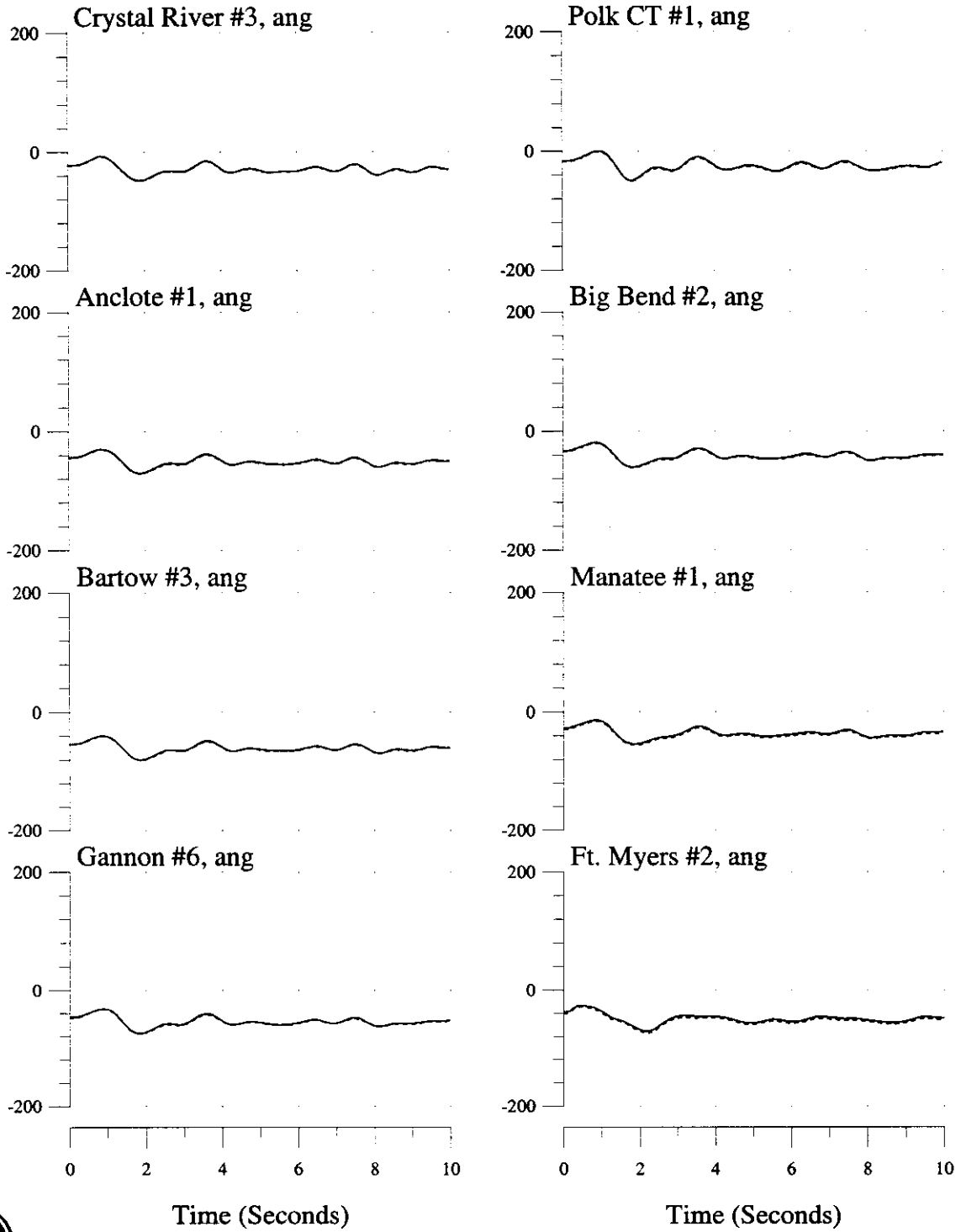

3-phase, 5-cycle Fault at Turkey Pt 230kV Bus, Trip Turkey Pt #3 & GSU
 2003 Summer System

Machine Variables: (—) With Okeechobee No. FPL Dispatch, (...) Without

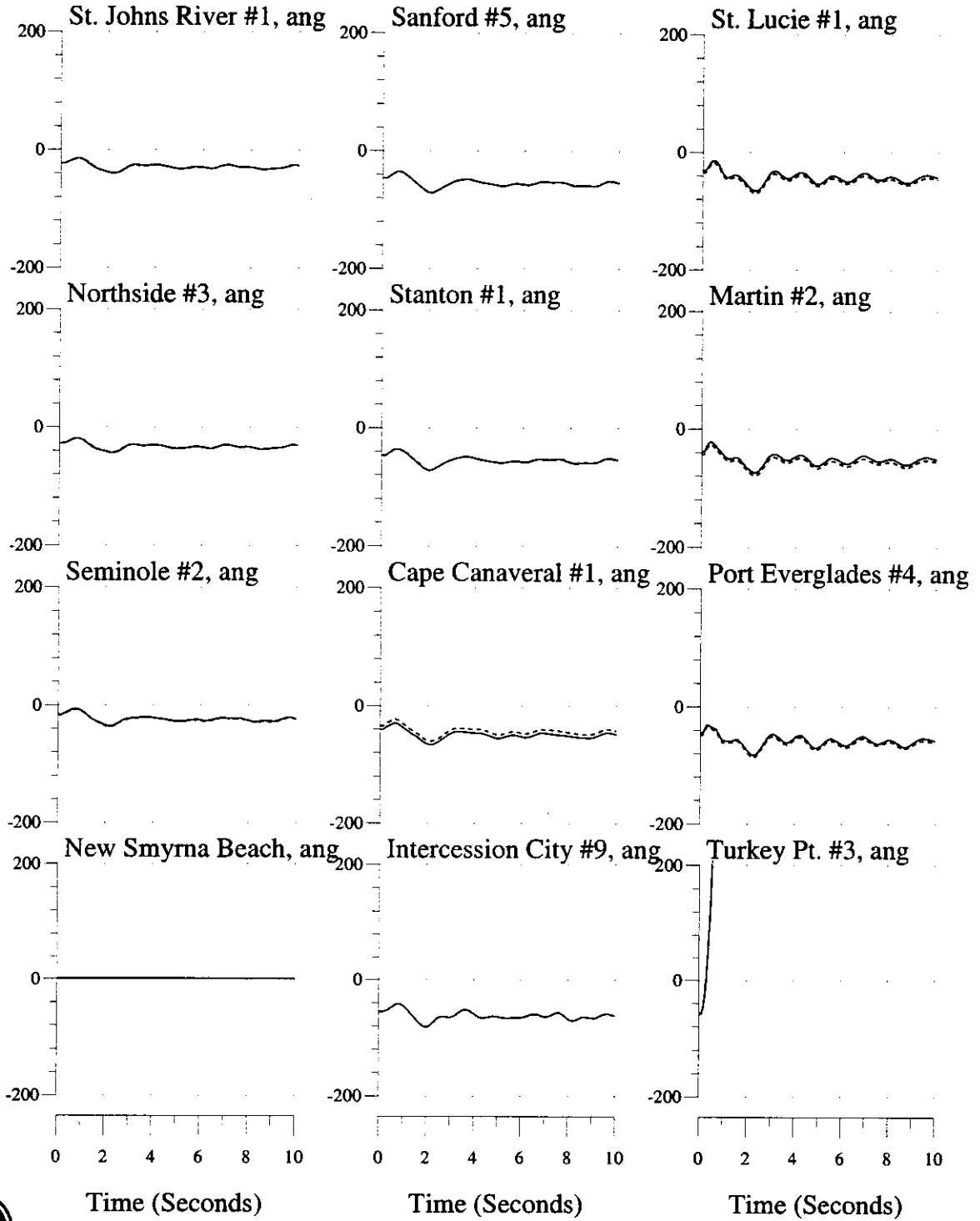

3-phase, 5-cycle Fault at Turkey Pt 230kV Bus, Trip Turkey Pt #3 & GSU
2003 Summer System

Bus Variables: (—) With Okeechobee No. FPL Dispatch, (...) Without

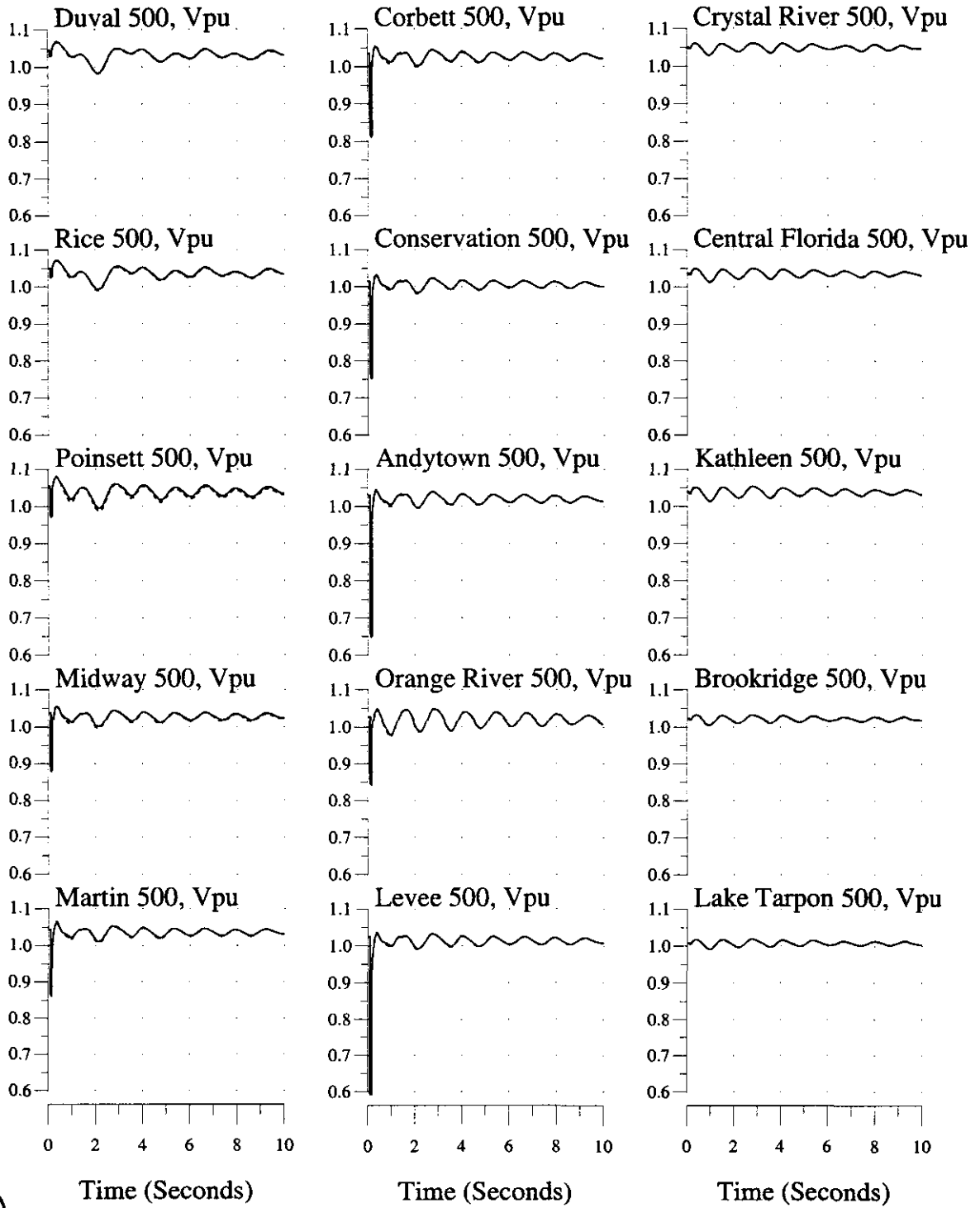

3-phase, 5-cycle Fault at Turkey Pt 230kV Bus, Trip Turkey Pt #3 & GSU
 2003 Summer System

Bus Variables: (___) With Okeechobee No. FPL Dispatch, (...) Without

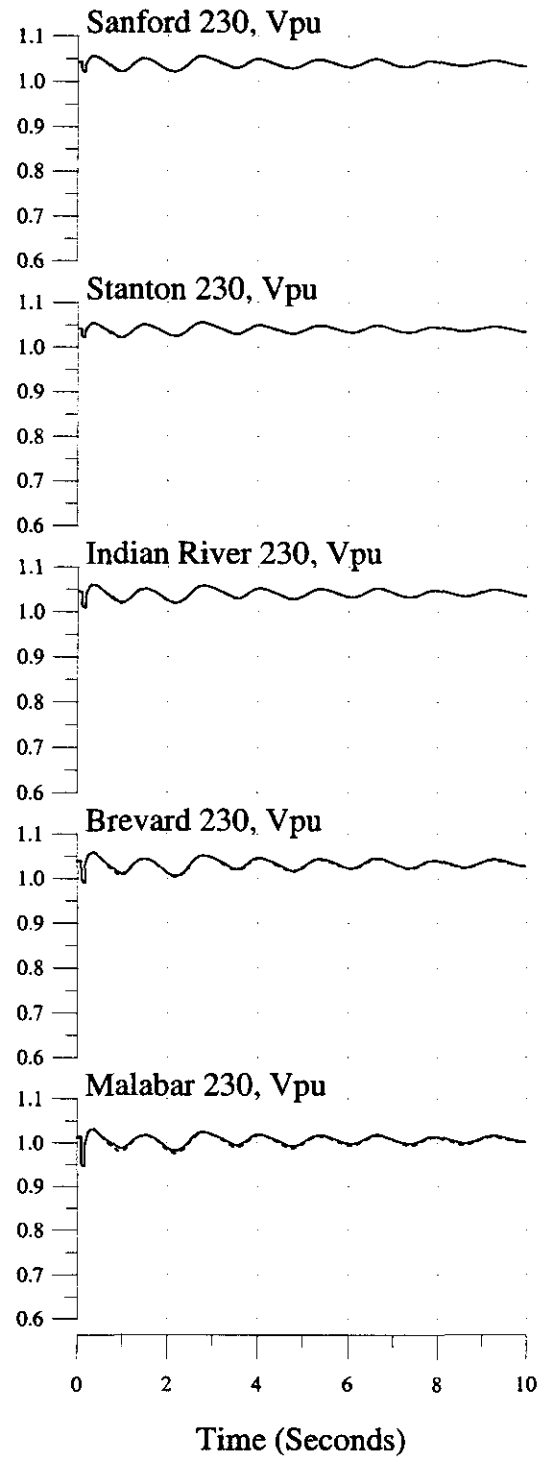
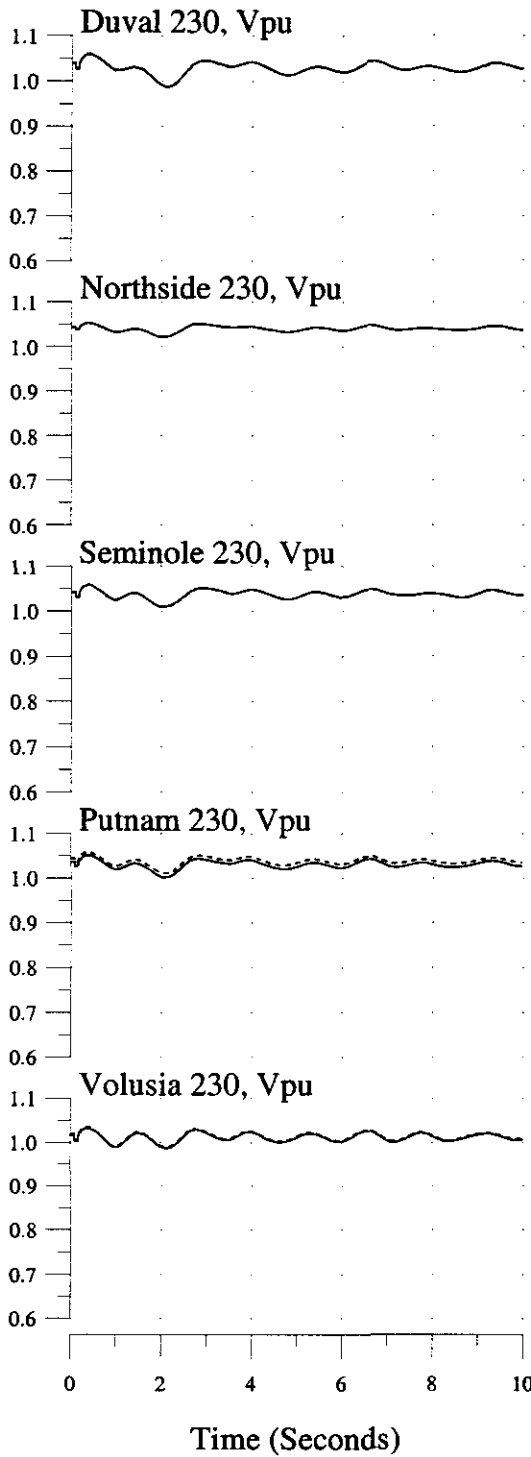

3-phase, 5-cycle Fault at Turkey Pt 230kV Bus, Trip Turkey Pt #3 & GSU
2003 Summer System

Bus Variables: (—) With Okeechobee No. FPL Dispatch, (...) Without

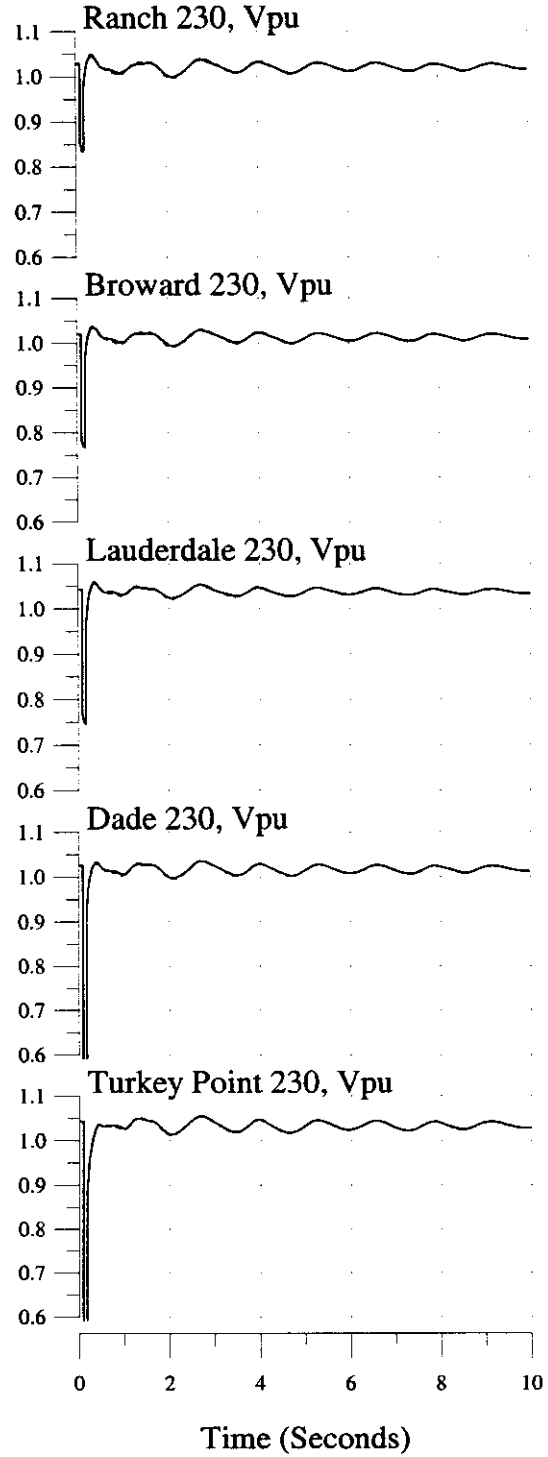
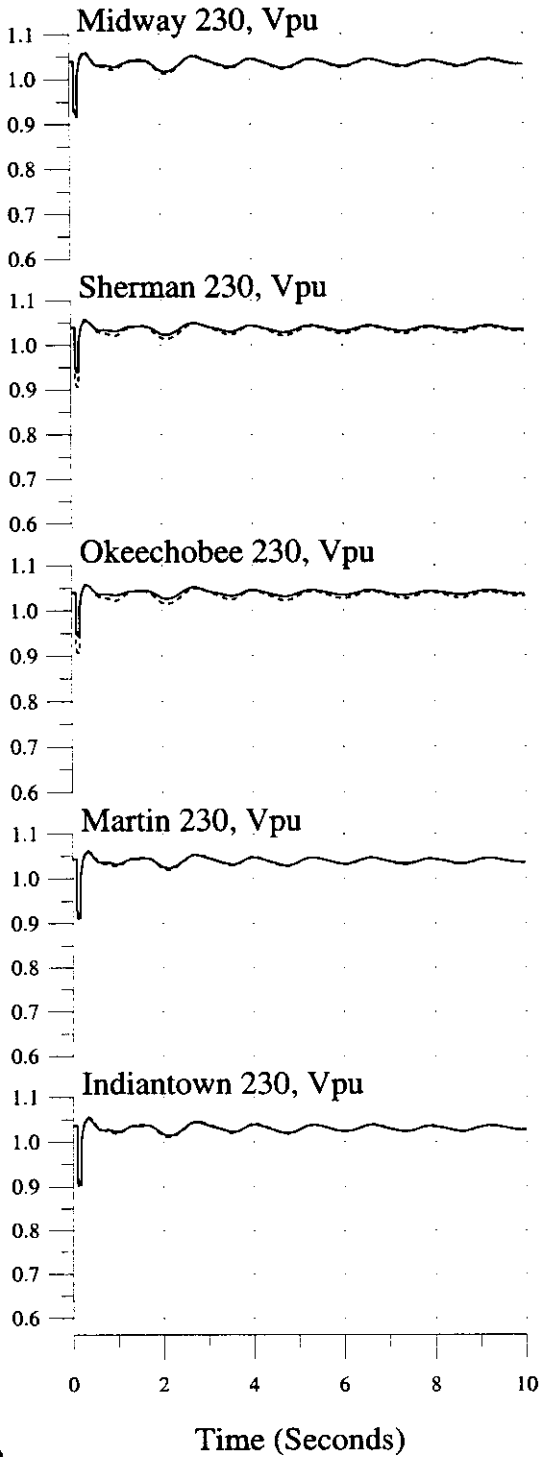

3-phase, 5-cycle Fault at Turkey Pt 230kV Bus, Trip Turkey Pt #3 & GSU
2003 Summer System

Bus Variables: (___) With Okeechobee No. FPL Dispatch, (...) Without

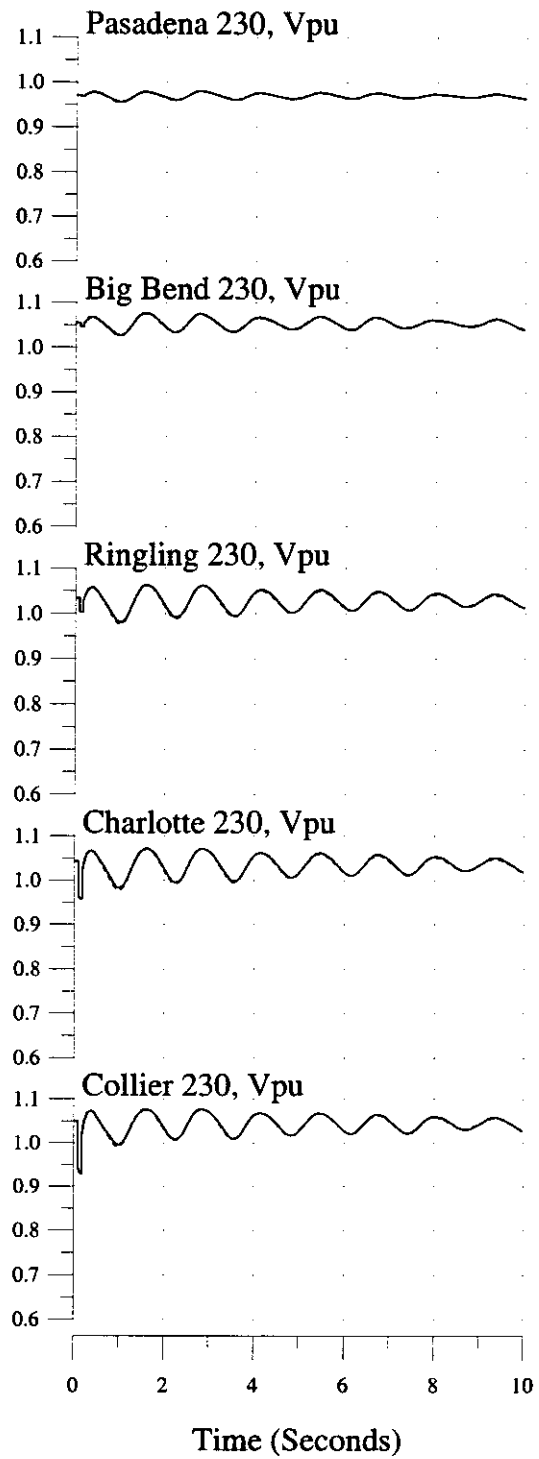
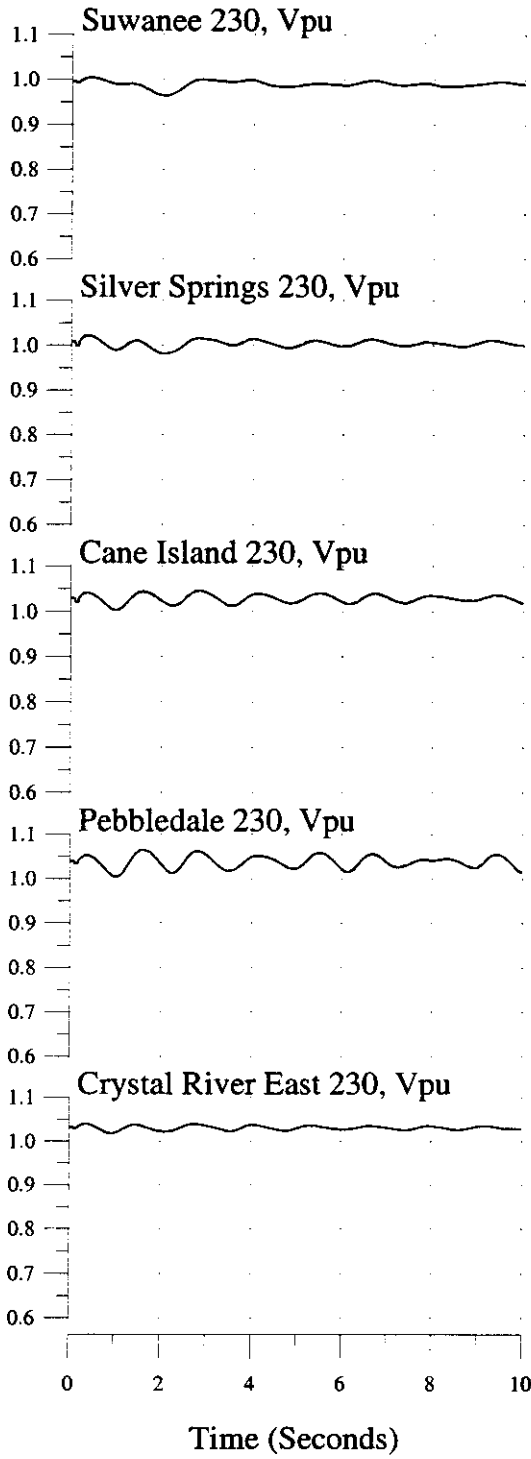

3-phase, 5-cycle Fault at Seminole 230kV Bus, Trip Seminole #1 & GSU
2003 Summer System

Machine & Interface Variables: (___) With Okeechobee No. FPL Dispatch, (...) Without

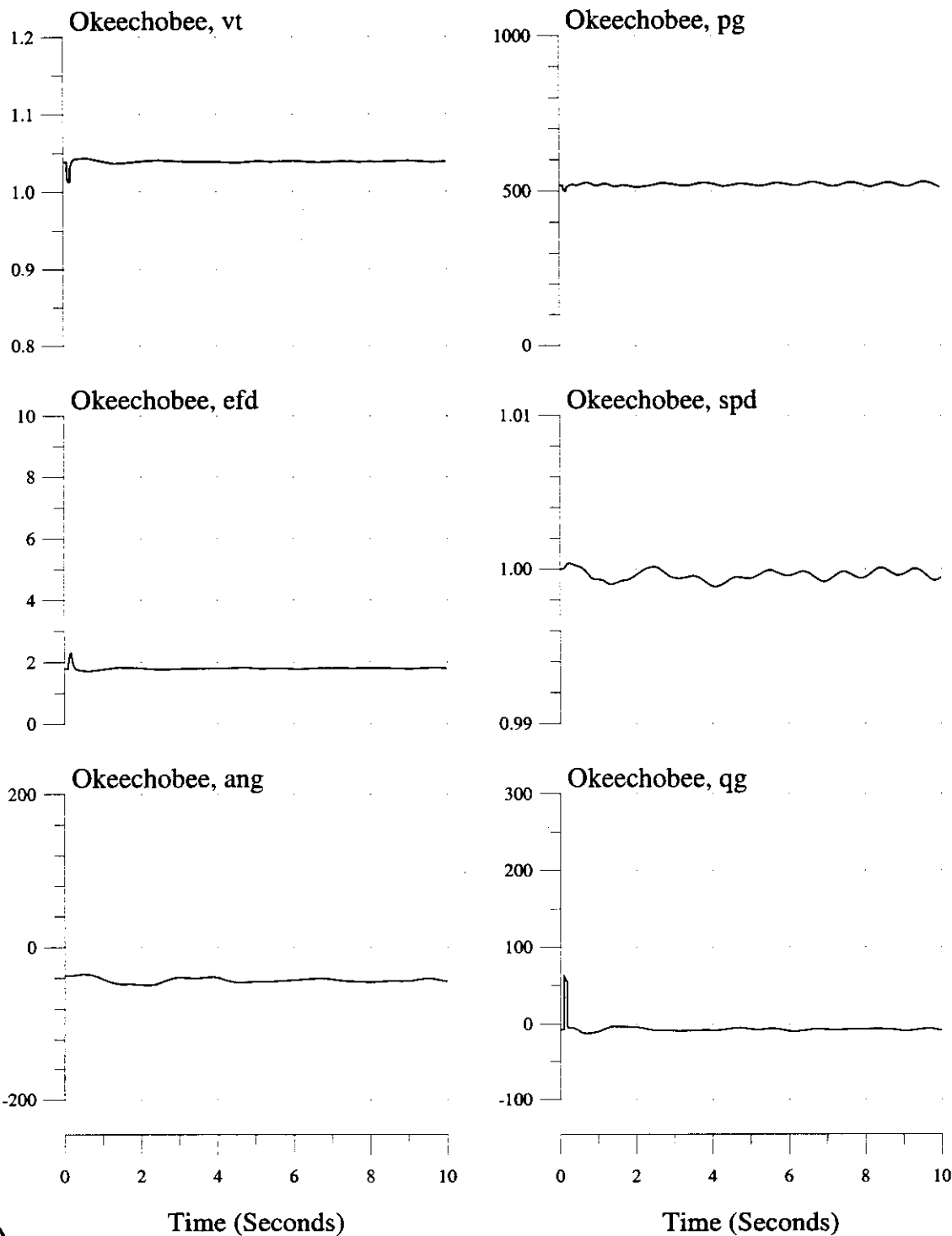

3-phase, 5-cycle Fault at Seminole 230kV Bus, Trip Seminole #1 & GSU
2003 Summer System

Machine & Interface Variables: (—) With Okeechobee No. FPL Dispatch, (...) Without

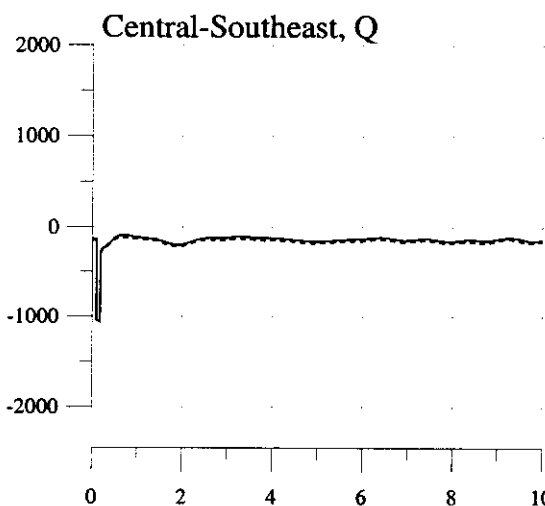
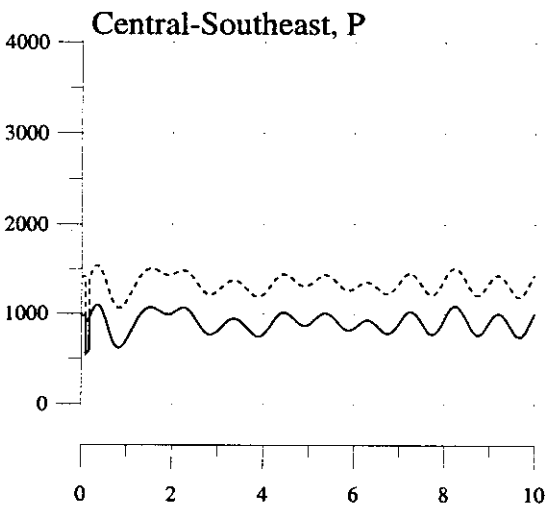
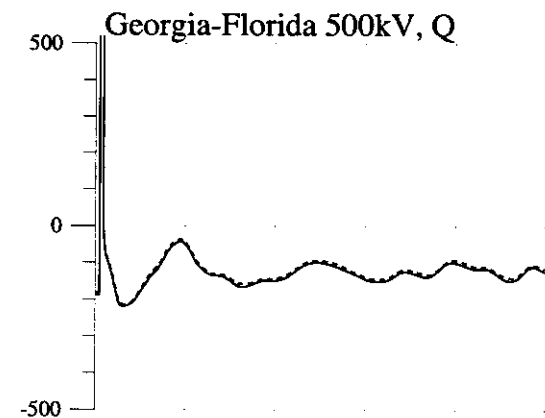
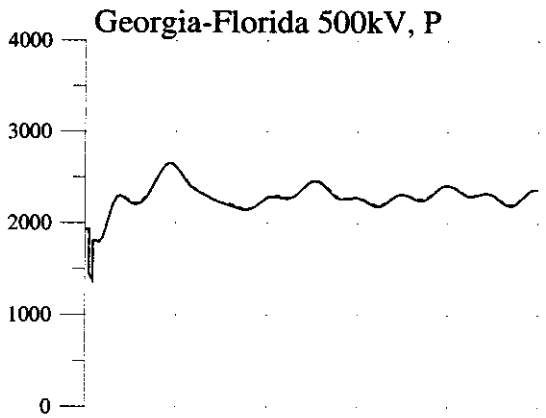
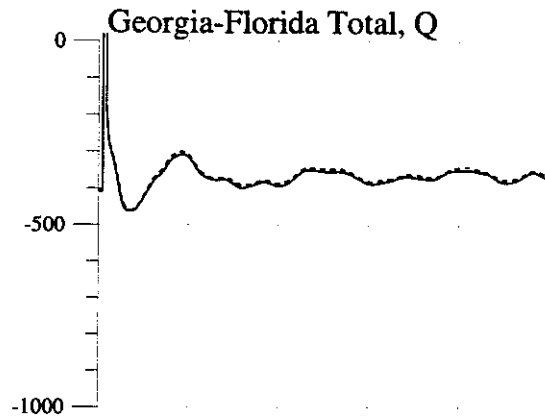
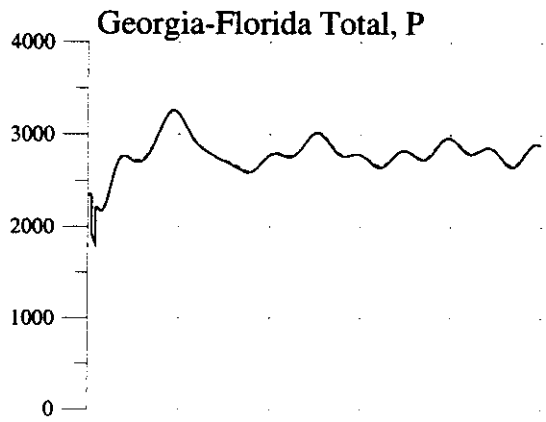

Time (Seconds)

Time (Seconds)



3-phase, 5-cycle Fault at Seminole 230kV Bus, Trip Seminole #1 & GSU
2003 Summer System

Machine Variables: (___) With Okeechobee No. FPL Dispatch, (...) Without

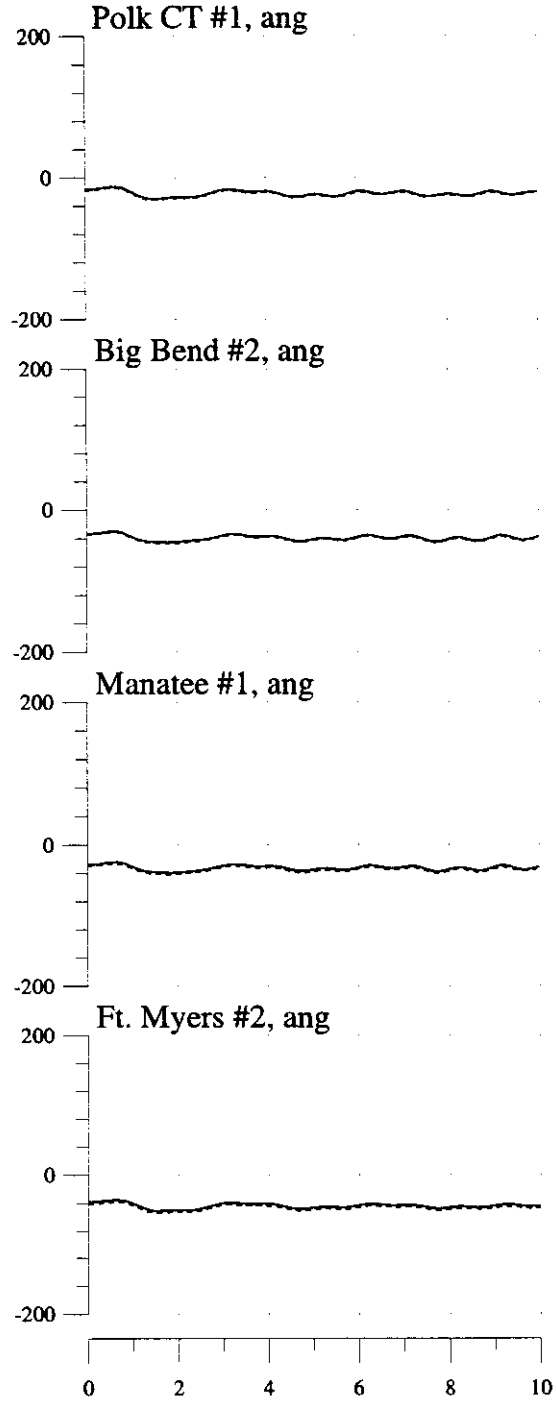
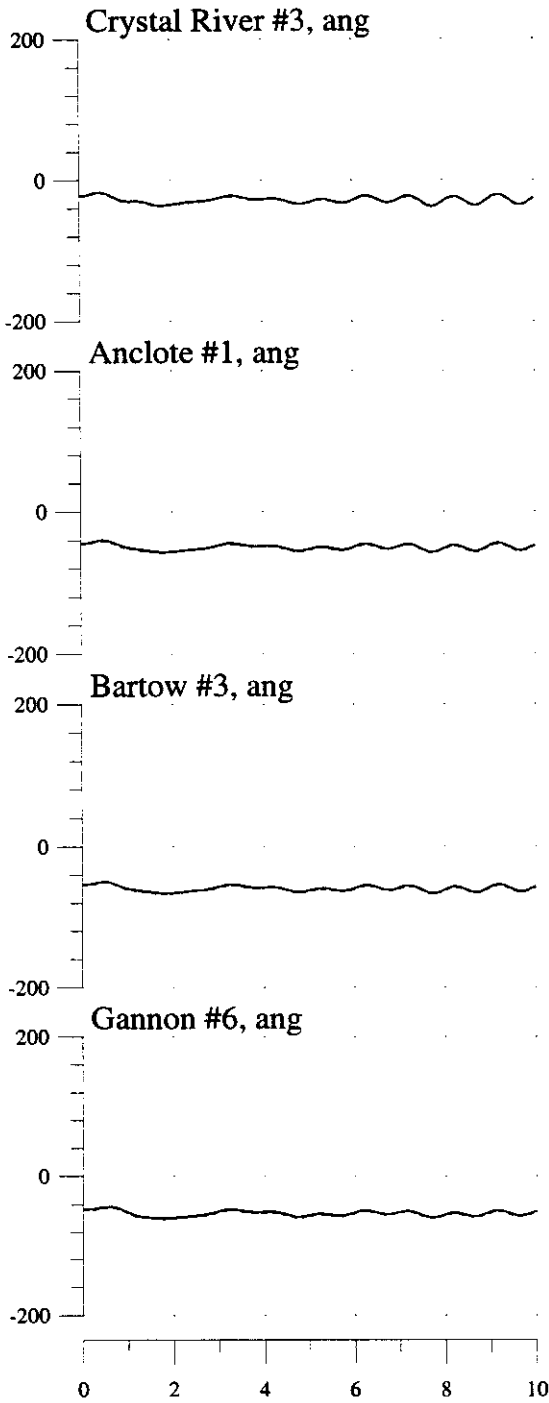

Time (Seconds)

Time (Seconds)



3-phase, 5-cycle Fault at Seminole 230kV Bus, Trip Seminole #1 & GSU
 2003 Summer System
 Machine Variables: (___) With Okeechobee No. FPL Dispatch, (...) Without

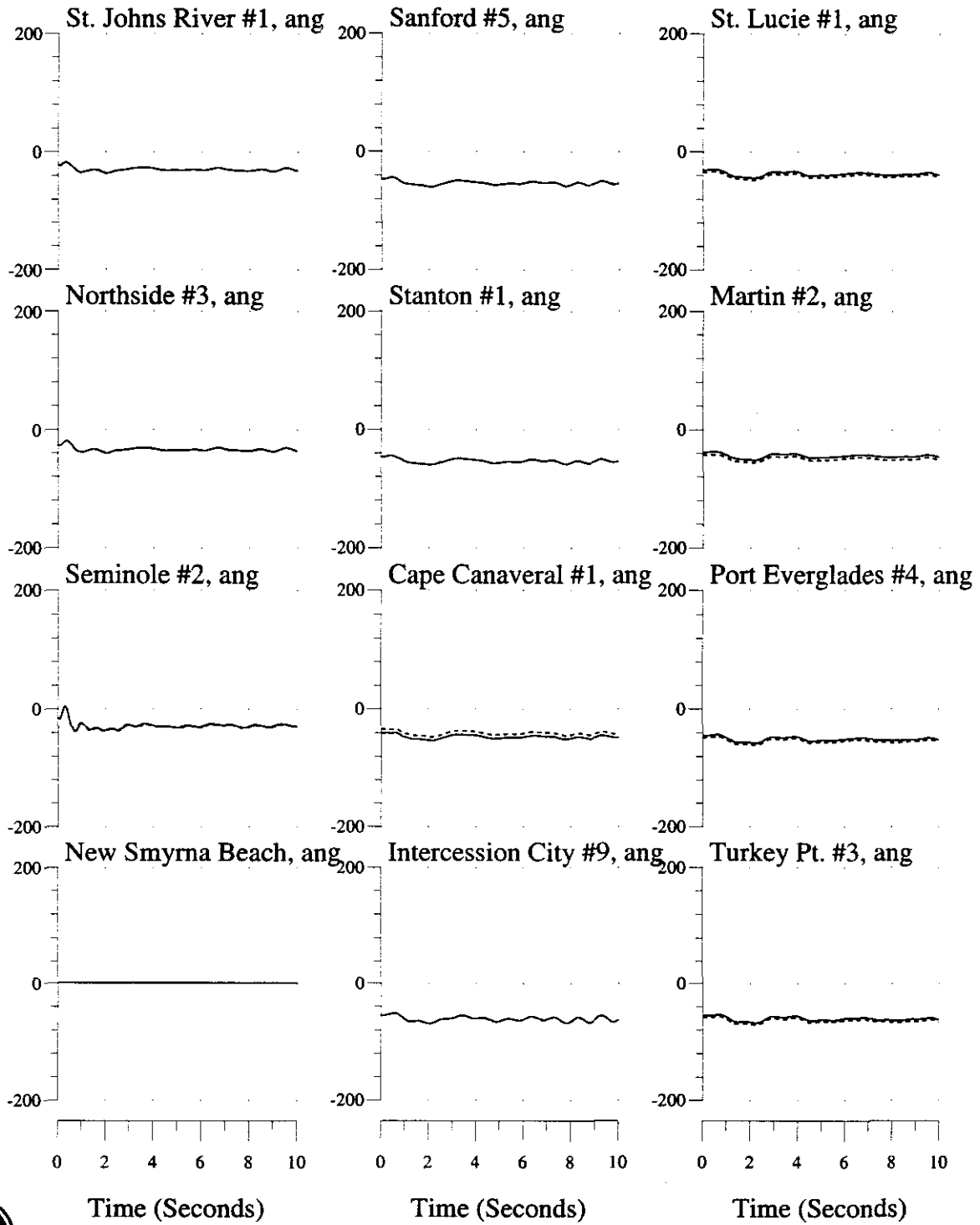

3-phase, 5-cycle Fault at Seminole 230kV Bus, Trip Seminole #1 & GSU 2003 Summer System

Bus Variables: (___) With Okeechobee No. FPL Dispatch, (...) Without

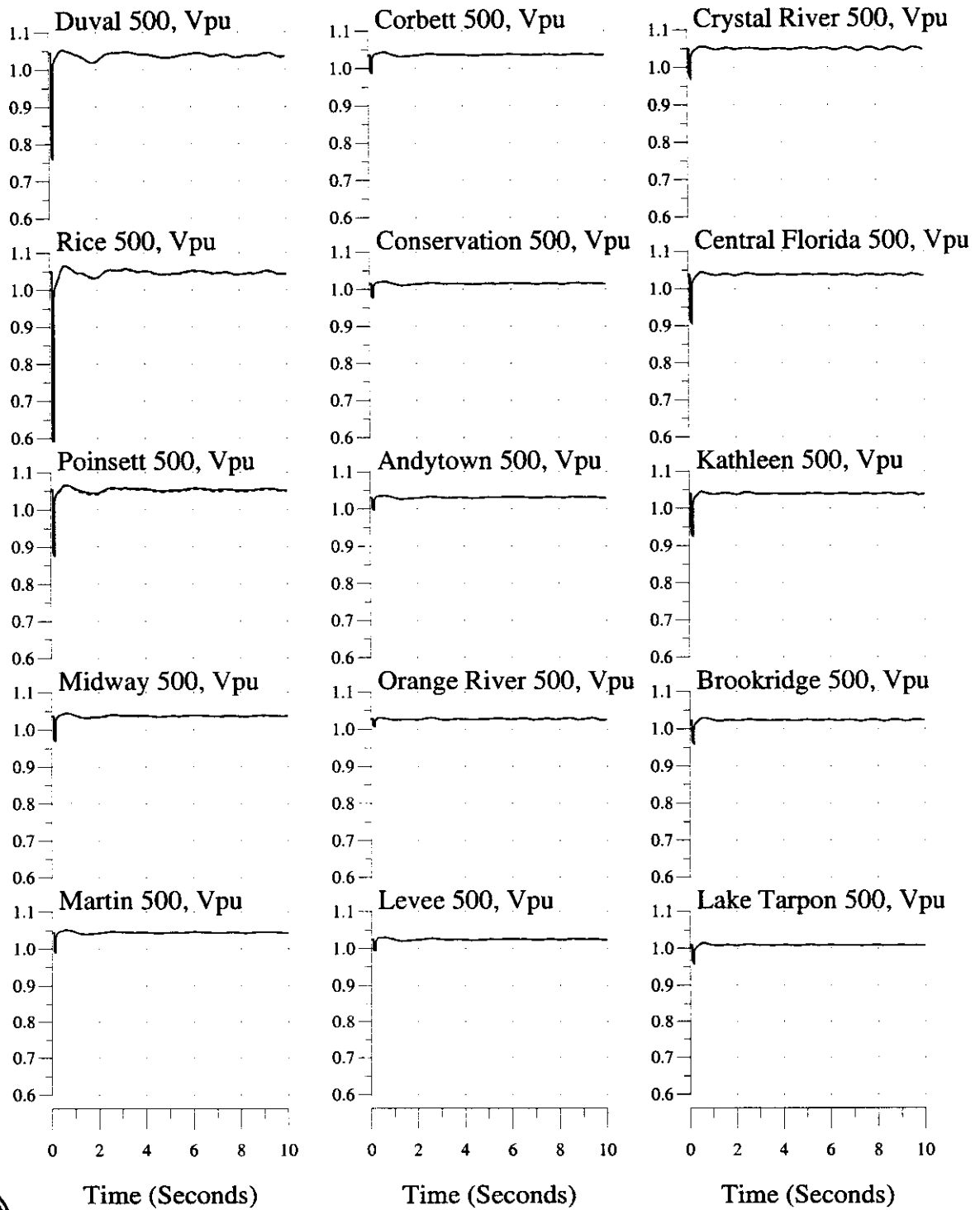

3-phase, 5-cycle Fault at Seminole 230kV Bus, Trip Seminole #1 & GSU
2003 Summer System

Bus Variables: (___) With Okeechobee No. FPL Dispatch, (...) Without

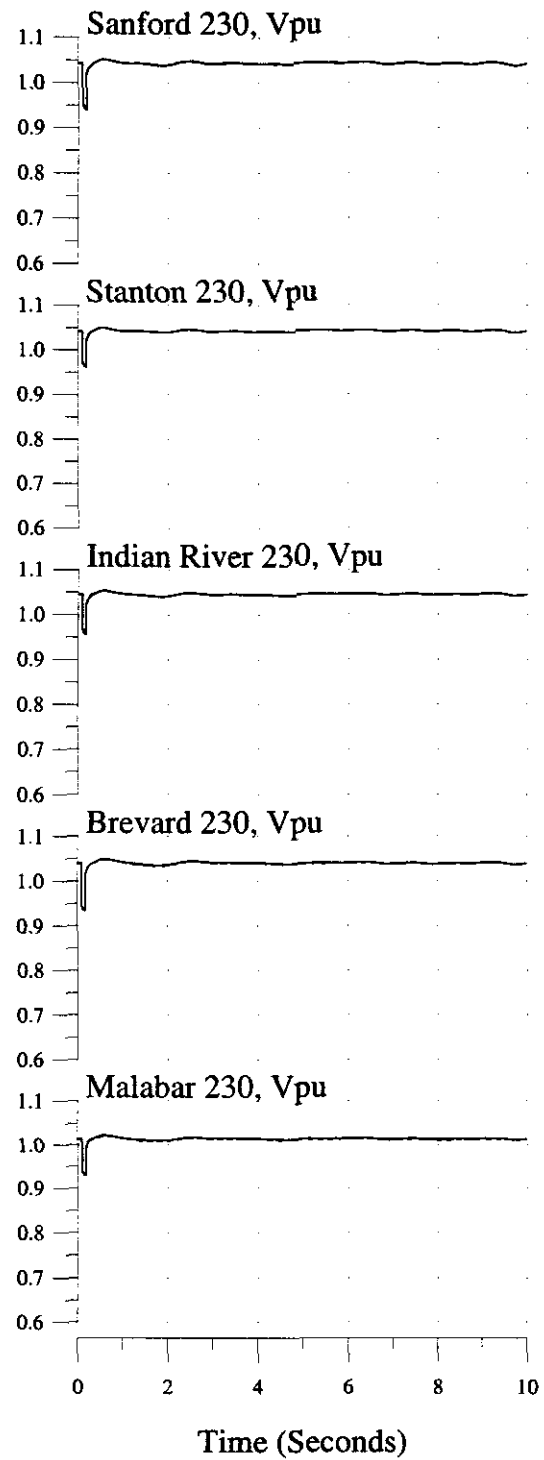
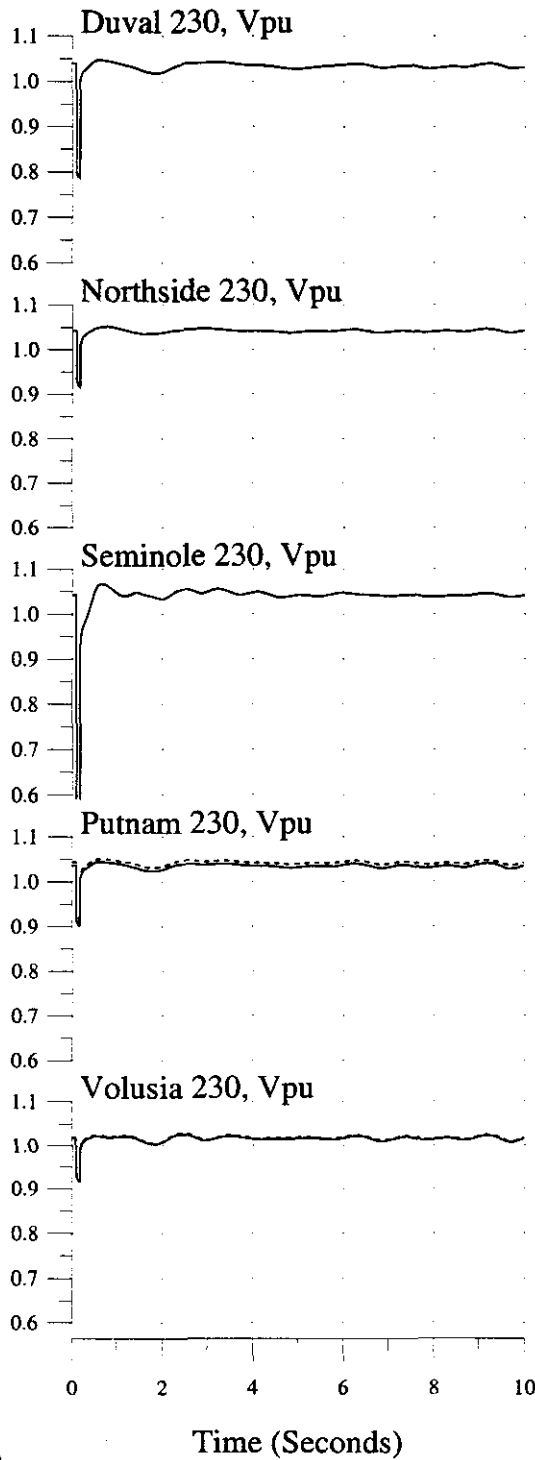

3-phase, 5-cycle Fault at Seminole 230kV Bus, Trip Seminole #1 & GSU
2003 Summer System

Bus Variables: (___) With Okeechobee No. FPL Dispatch, (...) Without

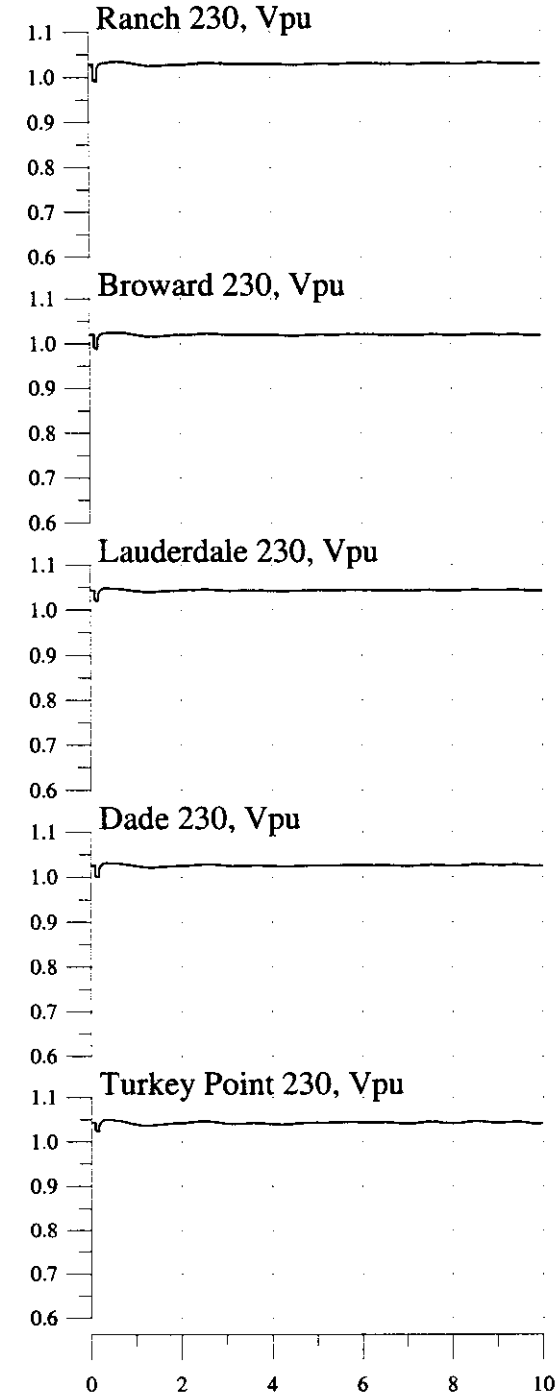
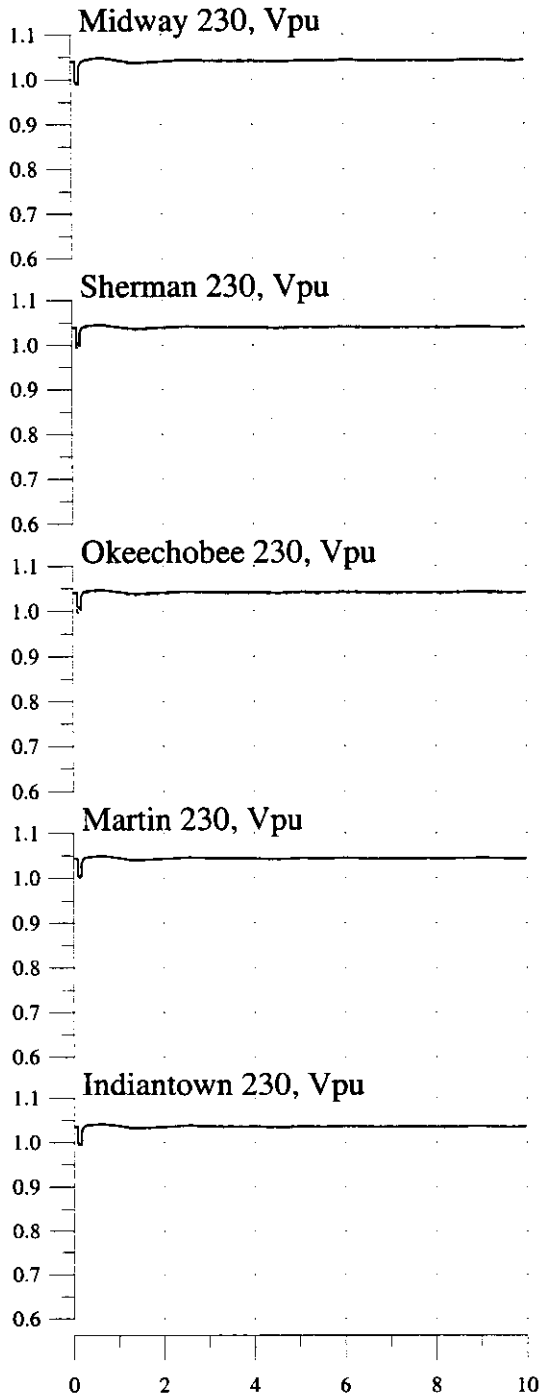

3-phase, 5-cycle Fault at Seminole 230kV Bus, Trip Seminole #1 & GSU
2003 Summer System

Bus Variables: (___) With Okeechobee No. FPL Dispatch, (...) Without

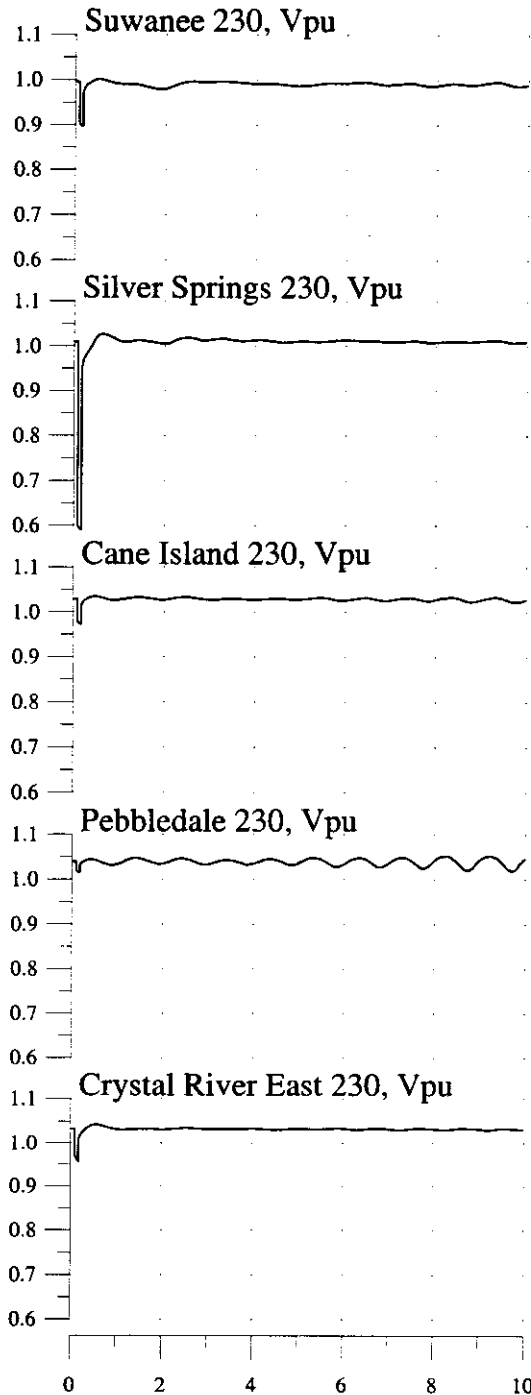

Time (Seconds)

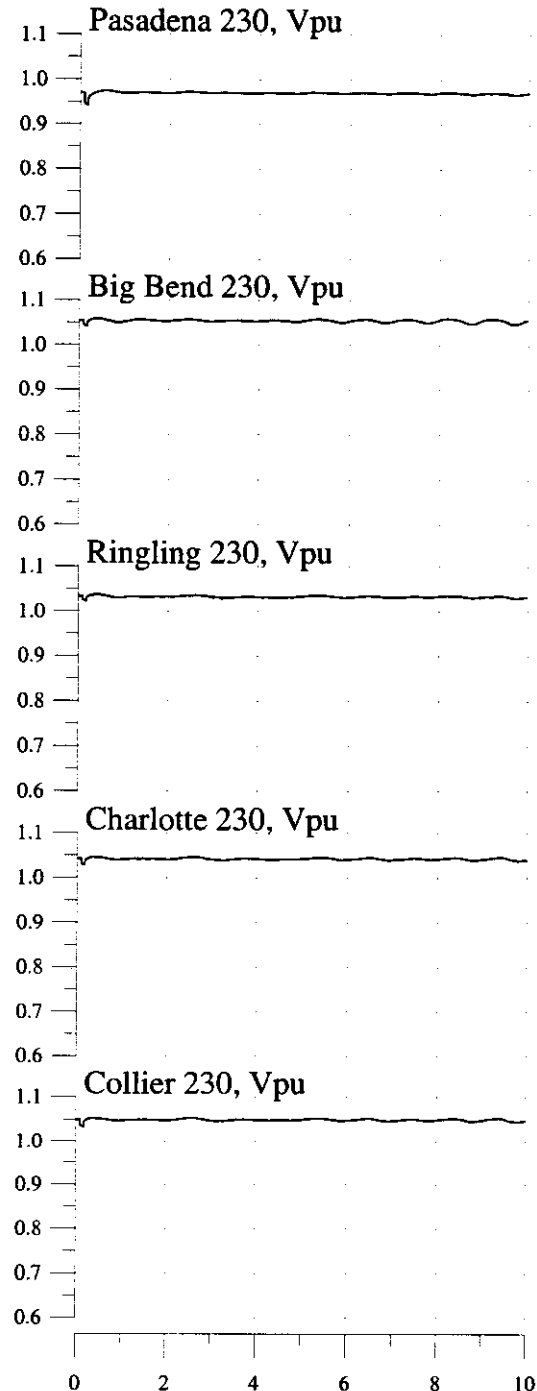

Time (Seconds)



3-phase, 5-cycle Fault at Martin 500kV Bus, Trip Martin #2 & GSU
2003 Summer System

Machine & Interface Variables: (___) With Okeechobee No. FPL Dispatch, (...) Without

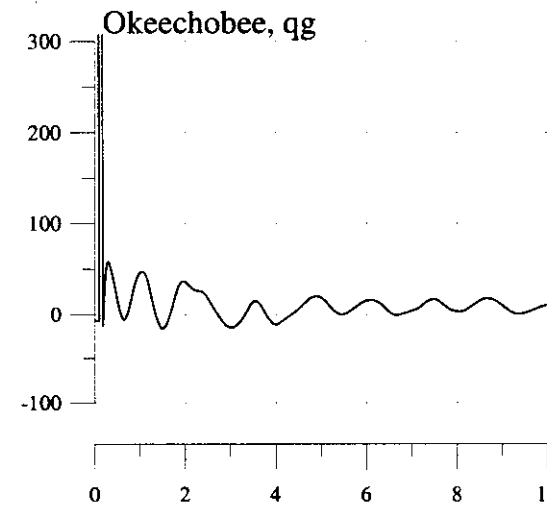
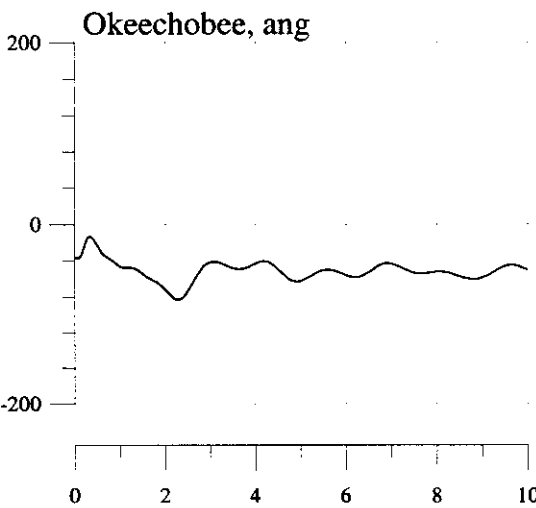
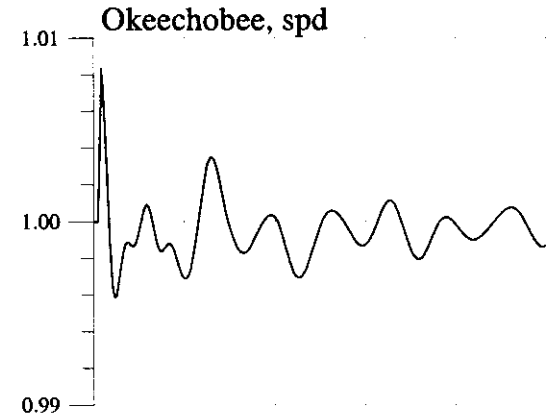
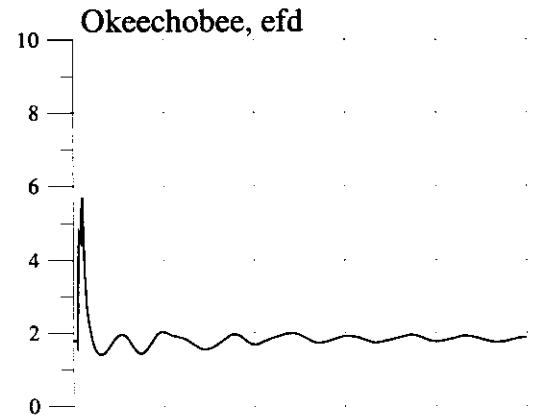
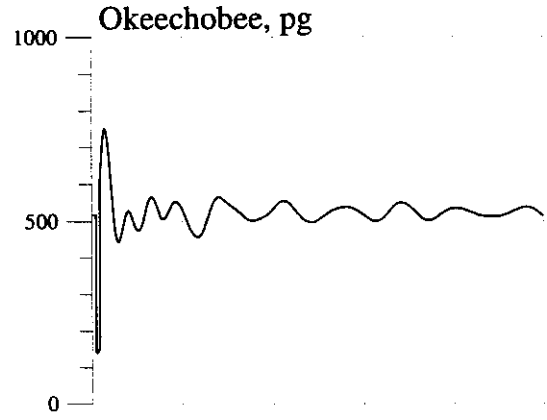
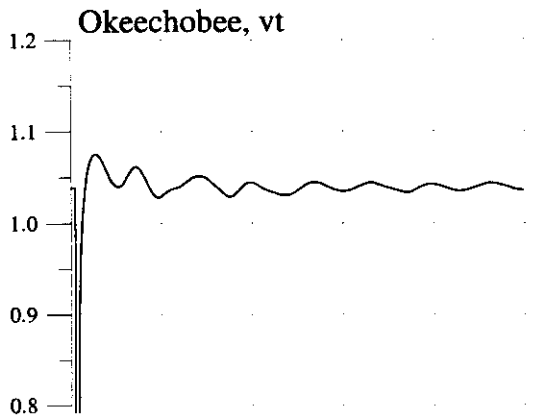

Time (Seconds)

Time (Seconds)



3-phase, 5-cycle Fault at Martin 500kV Bus, Trip Martin #2 & GSU
2003 Summer System

Machine & Interface Variables: (—) With Okeechobee No. FPL Dispatch, (...) Without

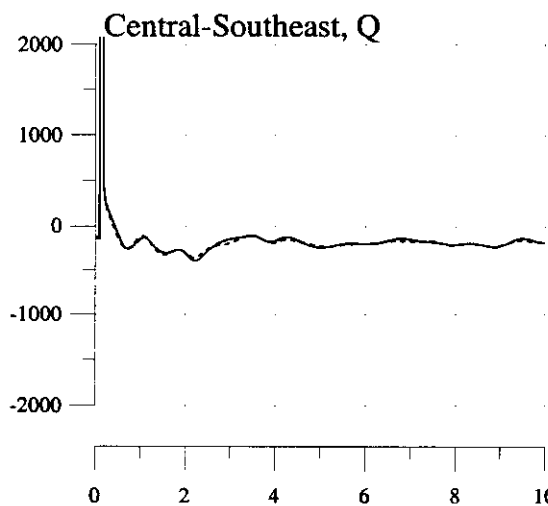
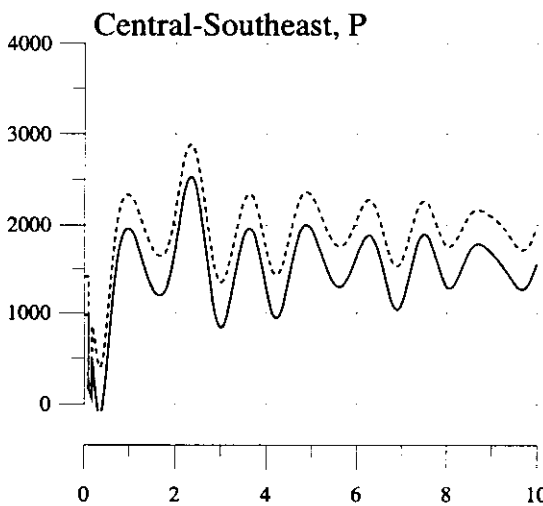
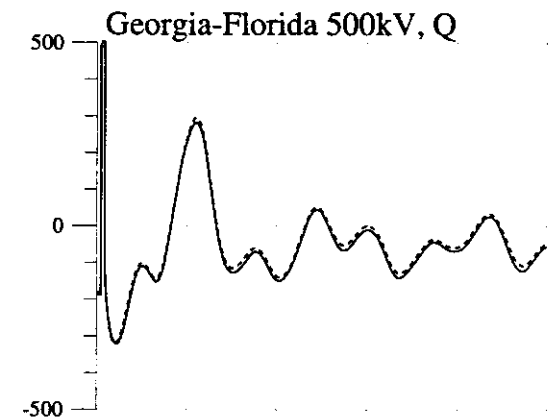
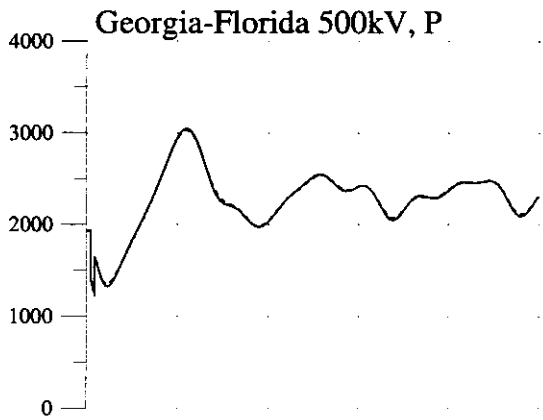
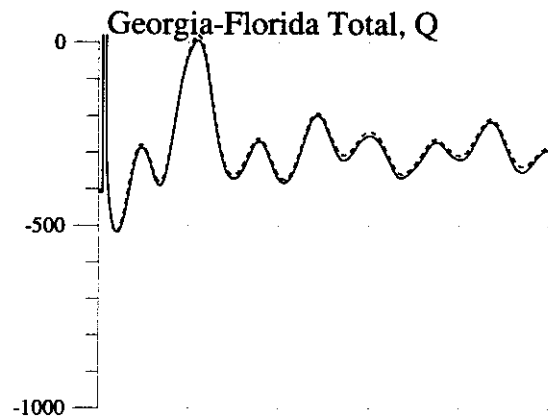
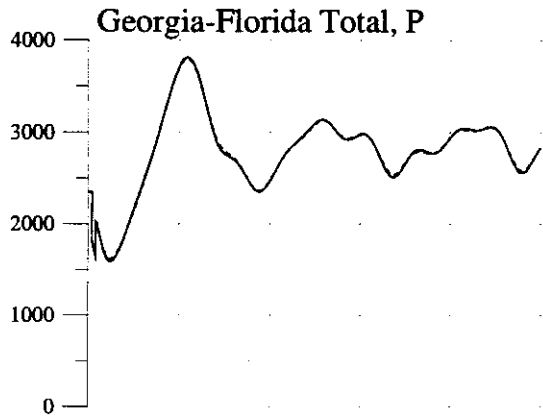

Time (Seconds)

Time (Seconds)



3-phase, 5-cycle Fault at Martin 500kV Bus, Trip Martin #2 & GSU
2003 Summer System

Machine Variables: (—) With Okeechobee No. FPL Dispatch, (...) Without

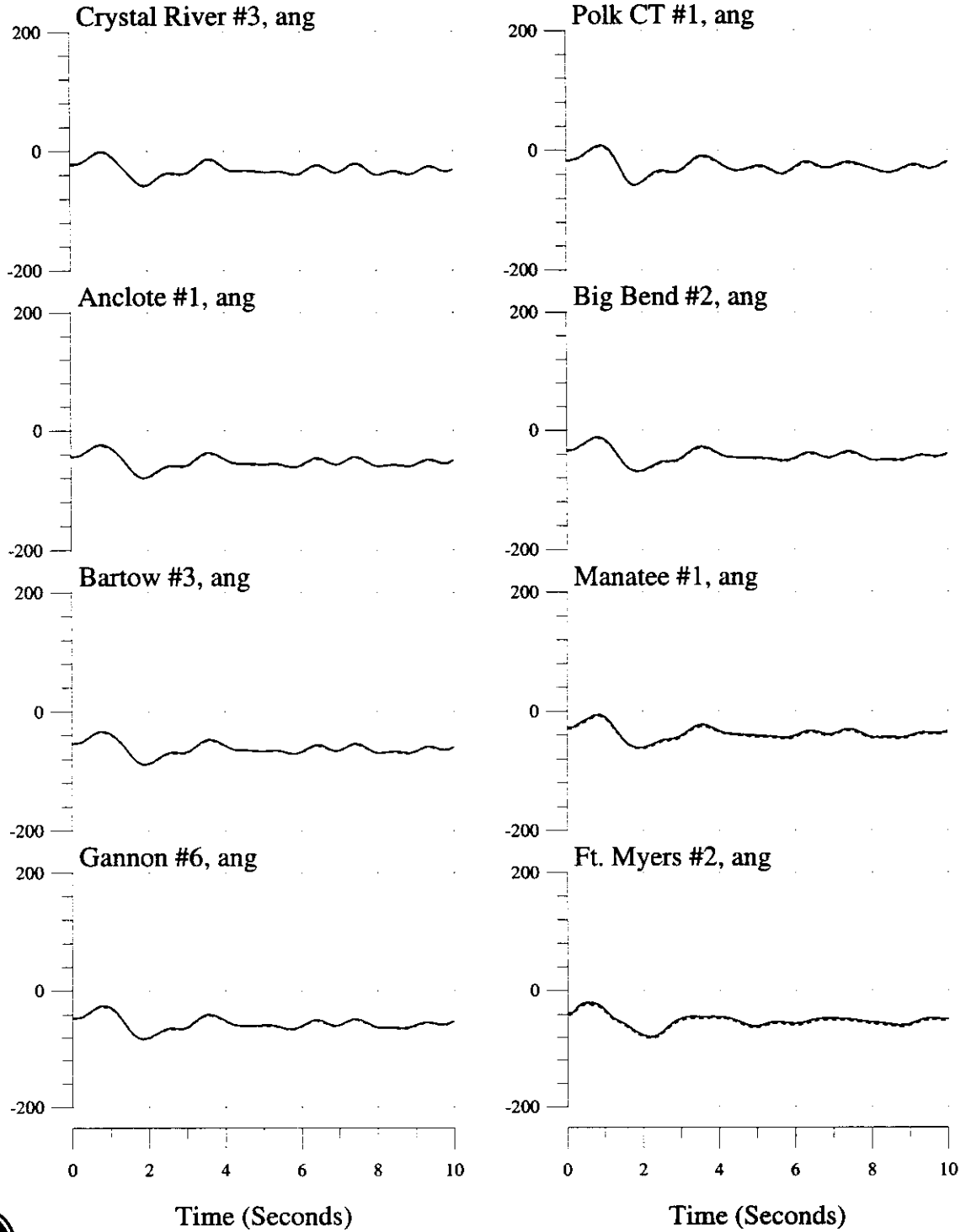

3-phase, 5-cycle Fault at Martin 500kV Bus, Trip Martin #2 & GSU
 2003 Summer System

Machine Variables: (___) With Okeechobee No. FPL Dispatch, (...) Without

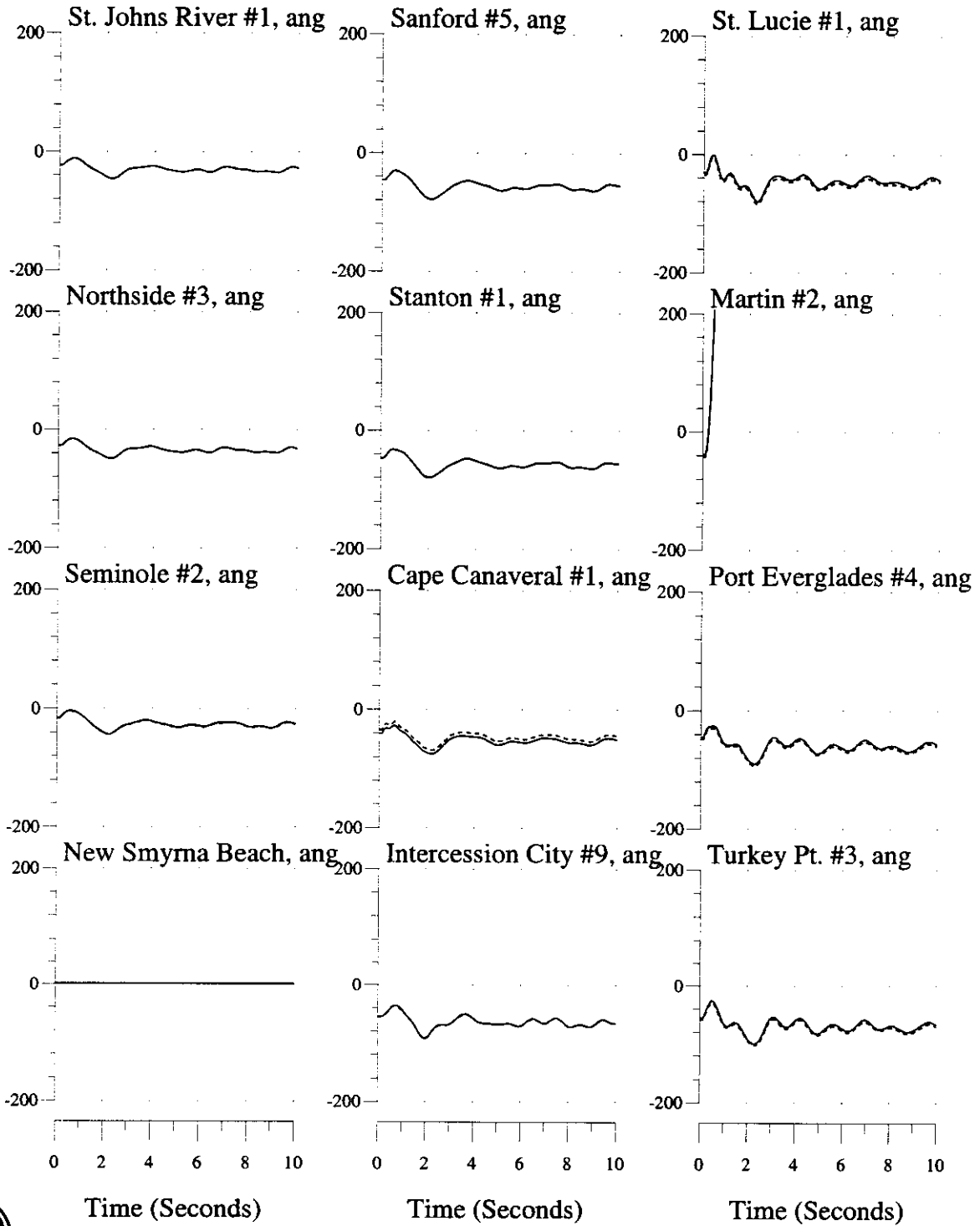

3-phase, 5-cycle Fault at Martin 500kV Bus, Trip Martin #2 & GSU
 2003 Summer System

Bus Variables: (—) With Okeechobee No. FPL Dispatch, (...) Without

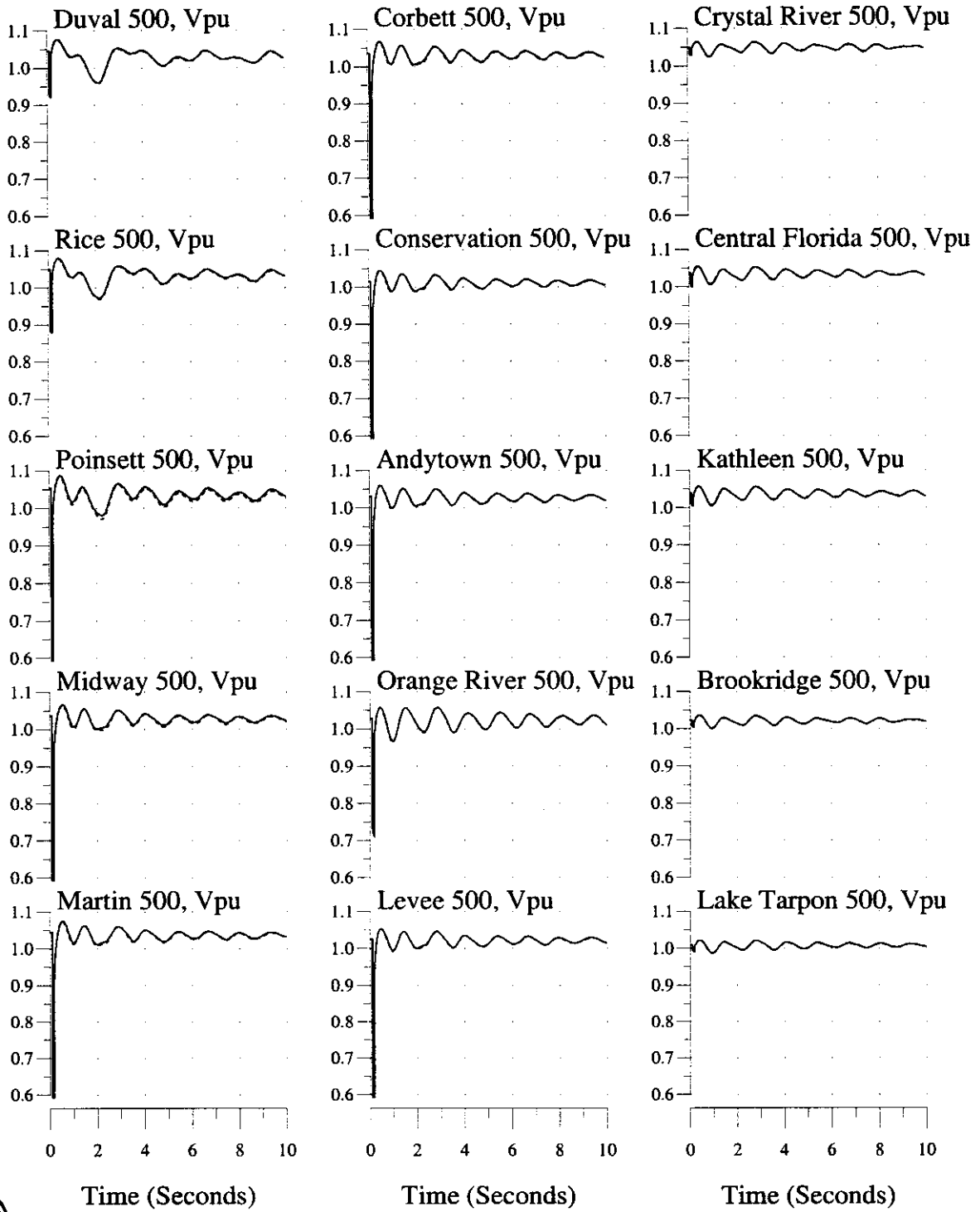

3-phase, 5-cycle Fault at Martin 500kV Bus, Trip Martin #2 & GSU
2003 Summer System

Bus Variables: (—) With Okeechobee No. FPL Dispatch, (...) Without

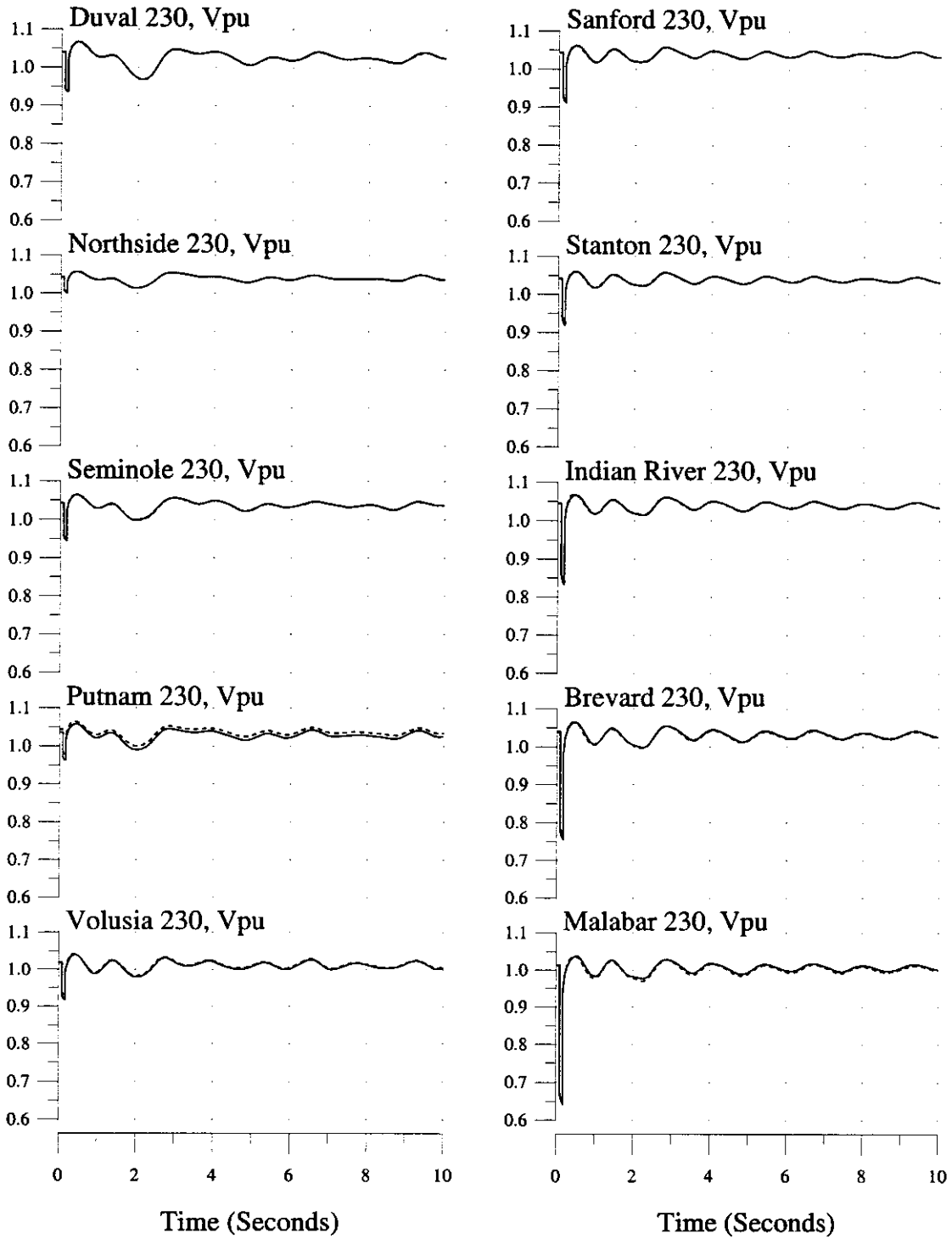

3-phase, 5-cycle Fault at Martin 500kV Bus, Trip Martin #2 & GSU
2003 Summer System

Bus Variables: (—) With Okeechobee No. FPL Dispatch, (...) Without

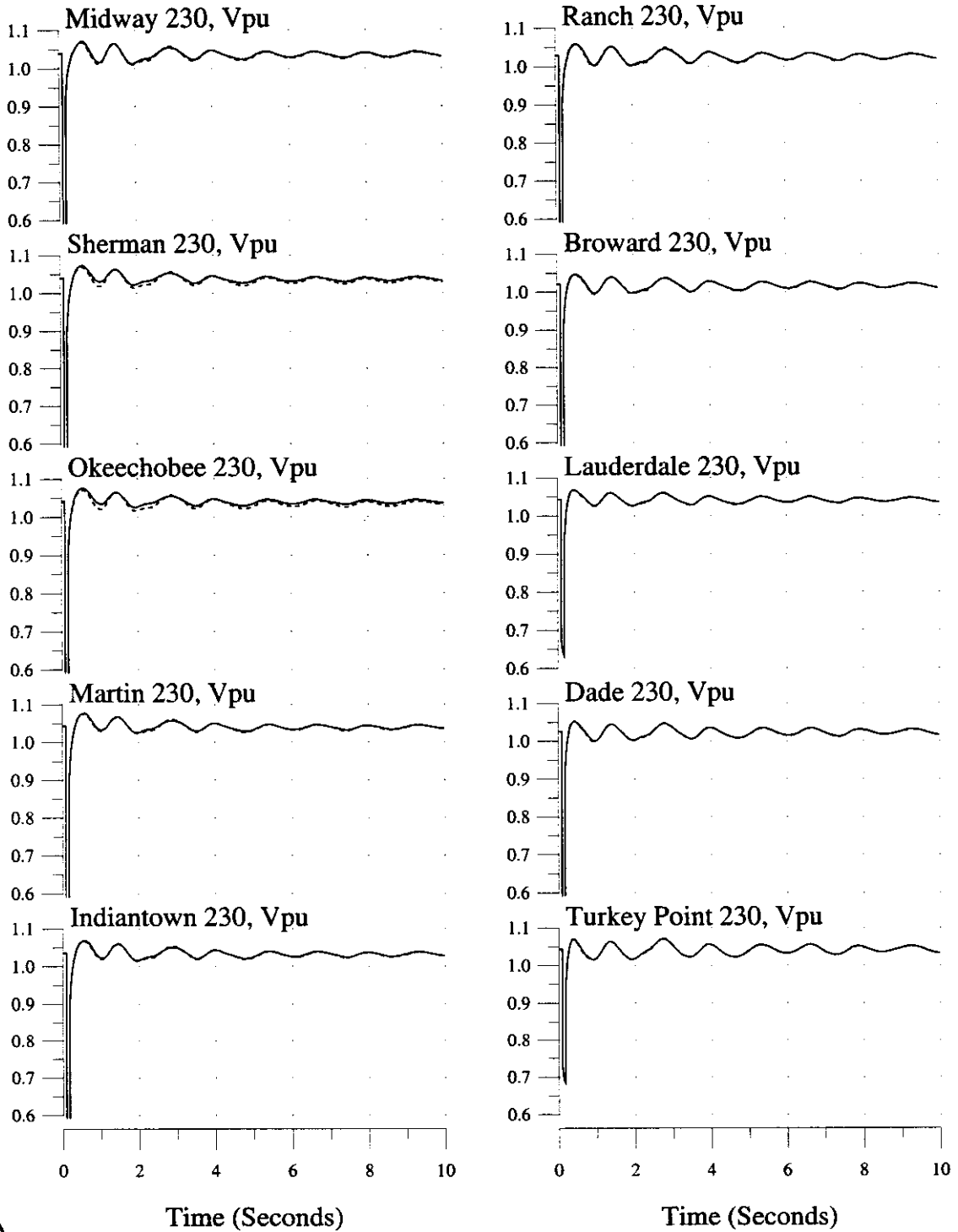

3-phase, 5-cycle Fault at Martin 500kV Bus, Trip Martin #2 & GSU
2003 Summer System

Bus Variables: (___) With Okeechobee No. FPL Dispatch, (...) Without

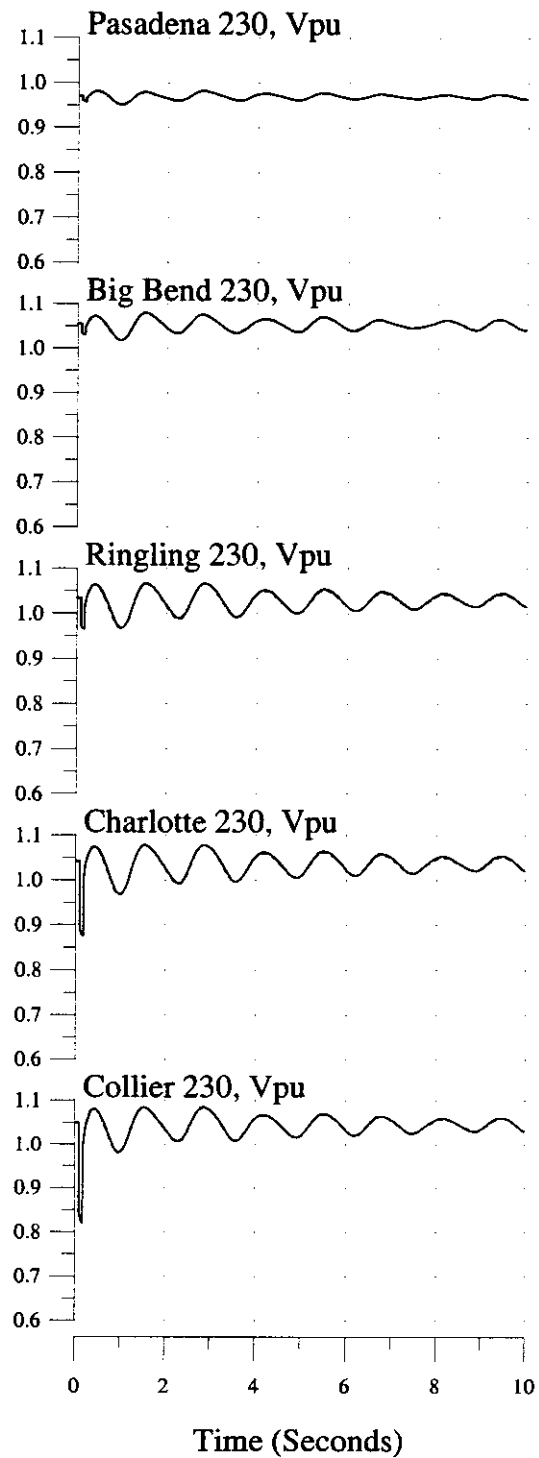
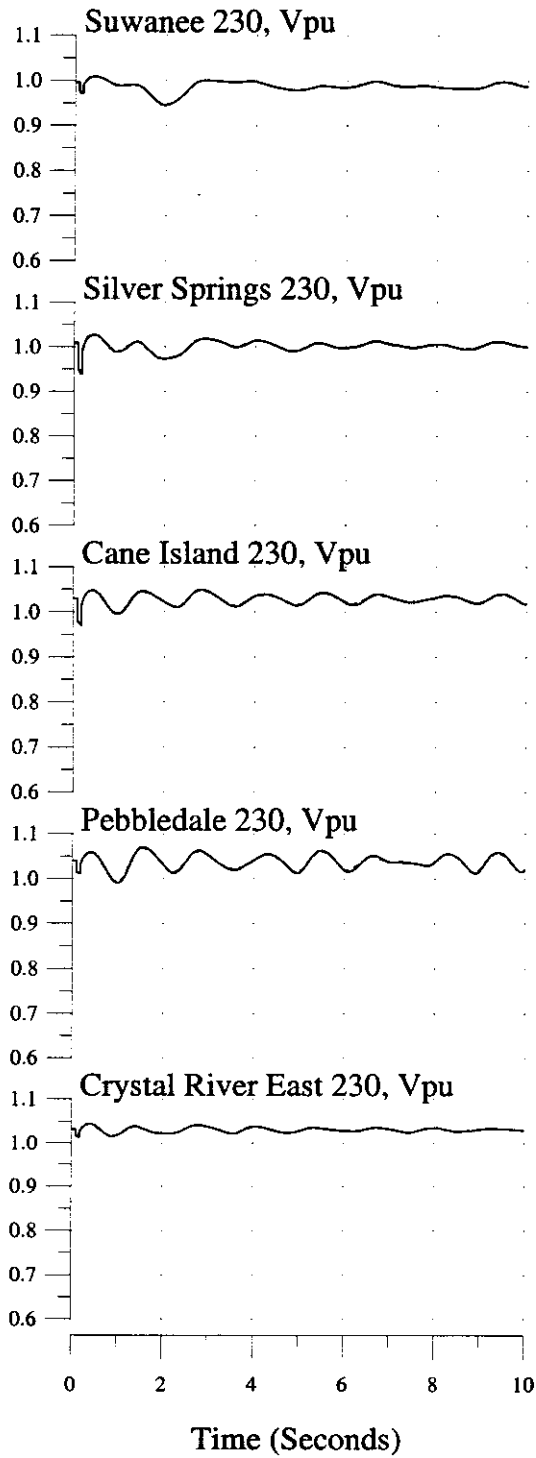

3-phase, 5-cycle Fault at Duval 500kV Bus, Trip Thalmann-Duval 500kV Line
2003 Summer System

Machine & Interface Variables: (___) With Okeechobee No. FPL Dispatch, (...) Without

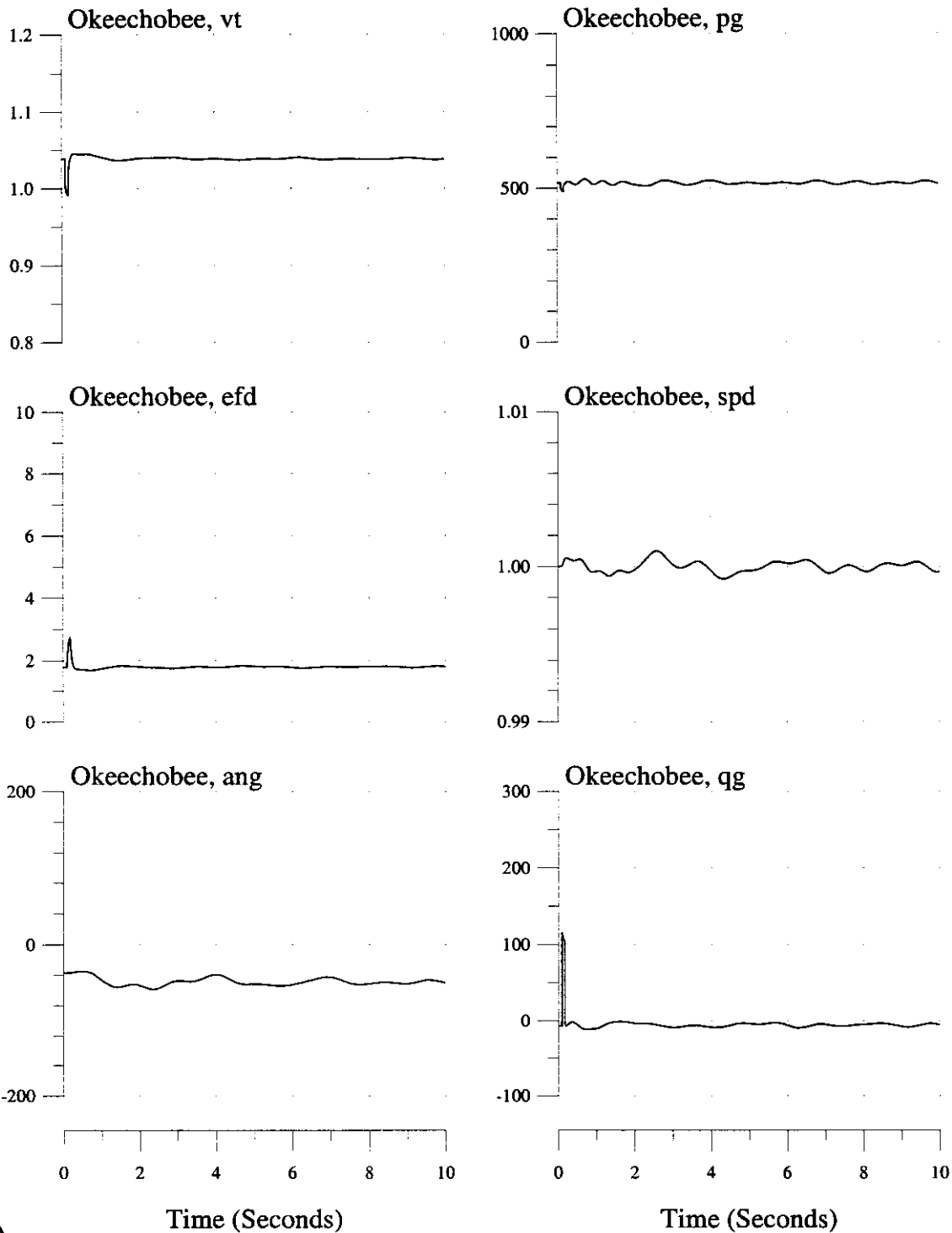

3-phase, 5-cycle Fault at Duval 500kV Bus, Trip Thalmann-Duval 500kV Line
2003 Summer System

Machine & Interface Variables: (—) With Okeechobee No. FPL Dispatch, (...) Without

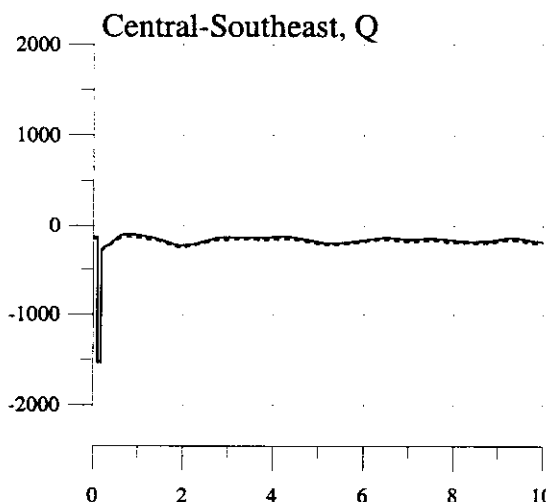
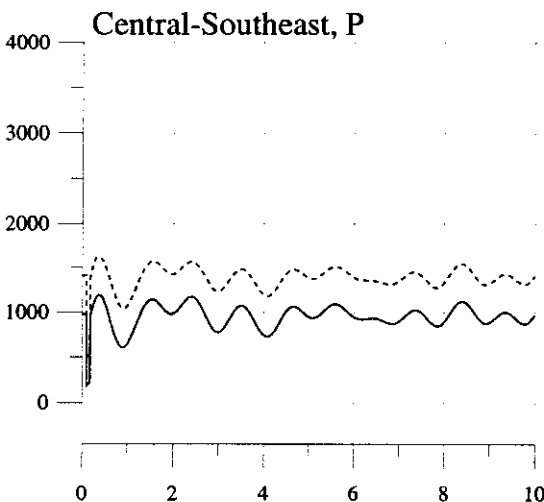
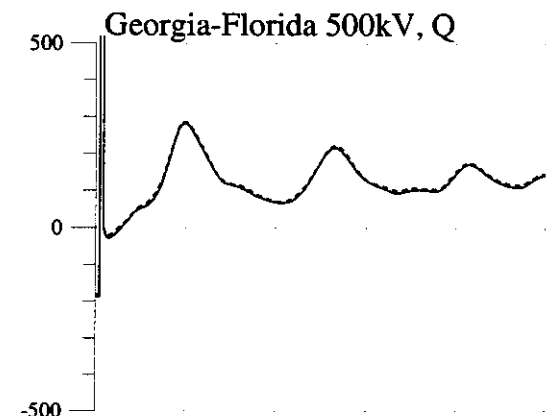
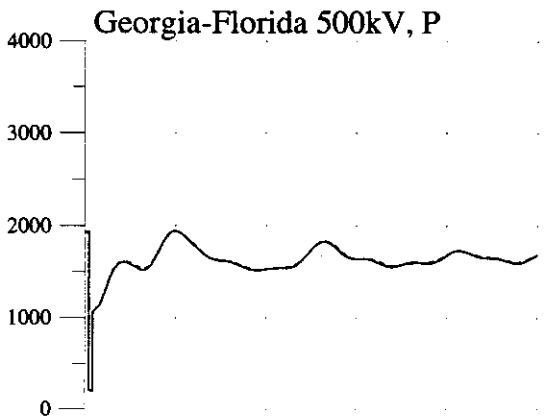
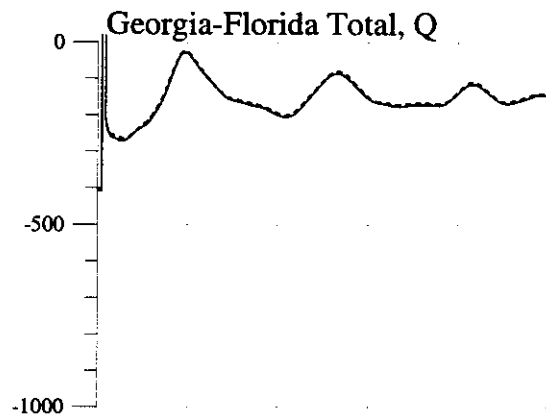
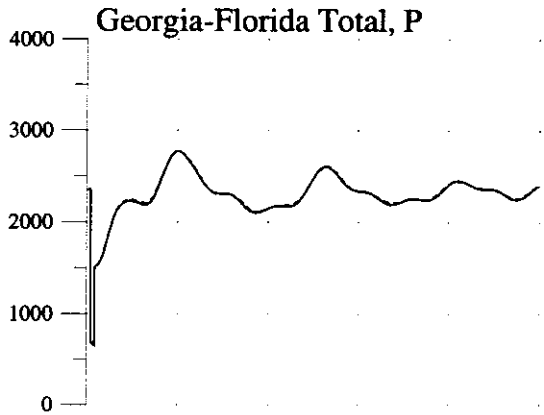

Time (Seconds)

Time (Seconds)



3-phase, 5-cycle Fault at Duval 500kV Bus, Trip Thalmann-Duval 500kV Line
2003 Summer System

Machine Variables: (—) With Okeechobee No. FPL Dispatch, (...) Without

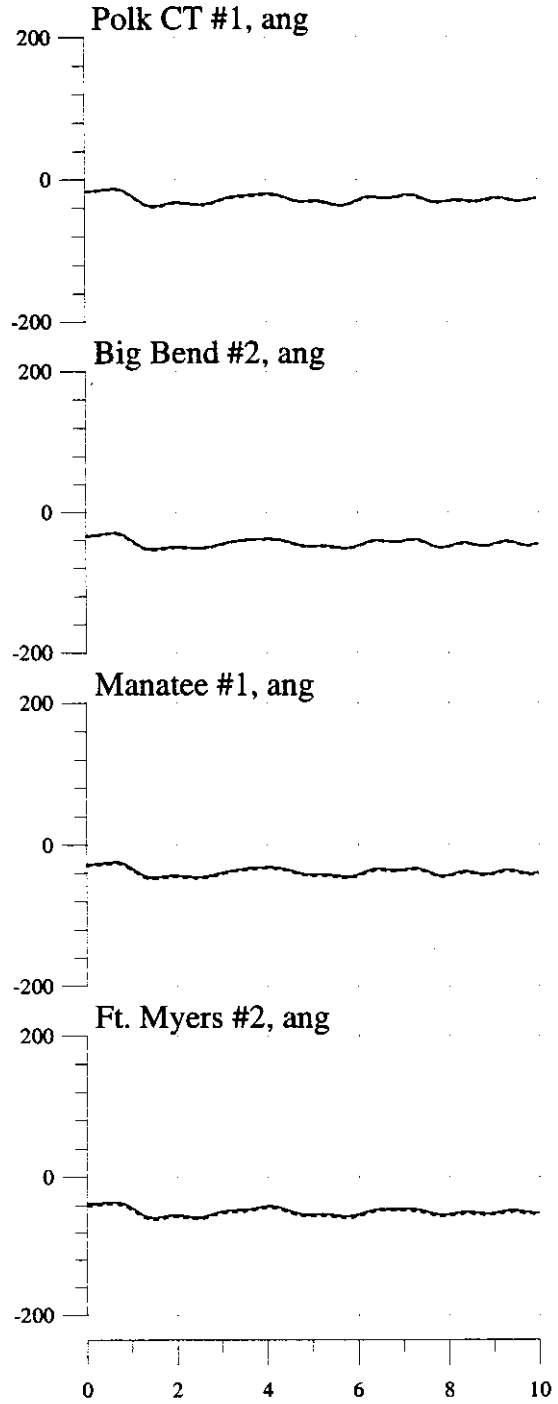
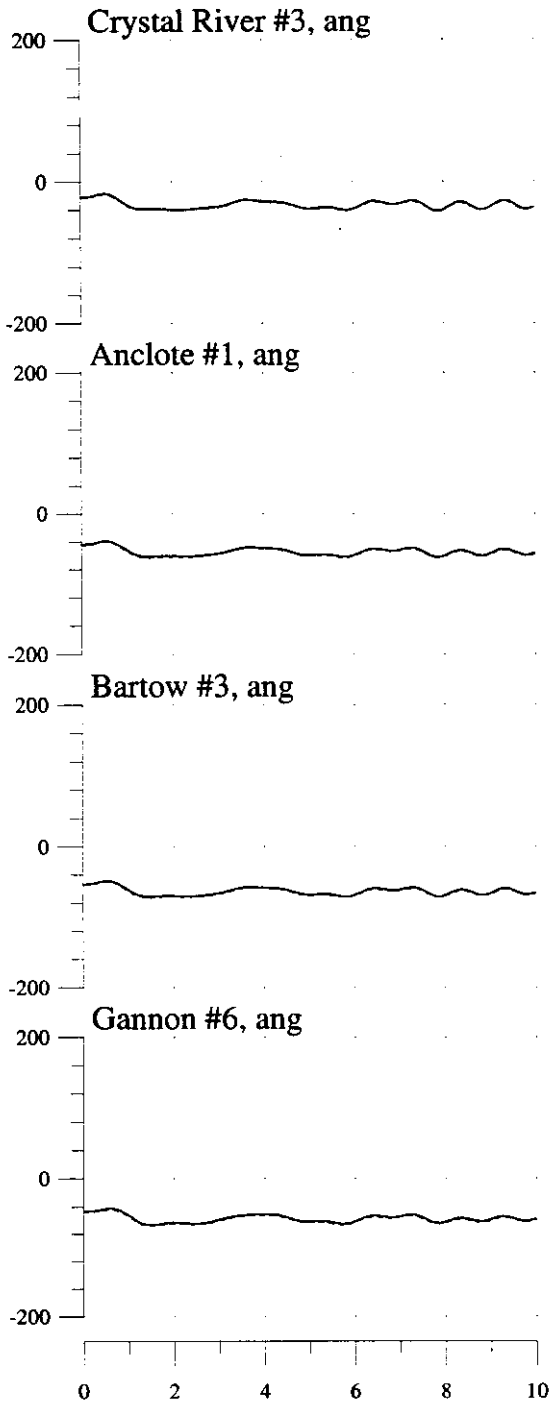

3-phase, 5-cycle Fault at Duval 500kV Bus, Trip Thalmann-Duval 500kV Line
2003 Summer System

Machine Variables: (—) With Okeechobee No. FPL Dispatch, (...) Without

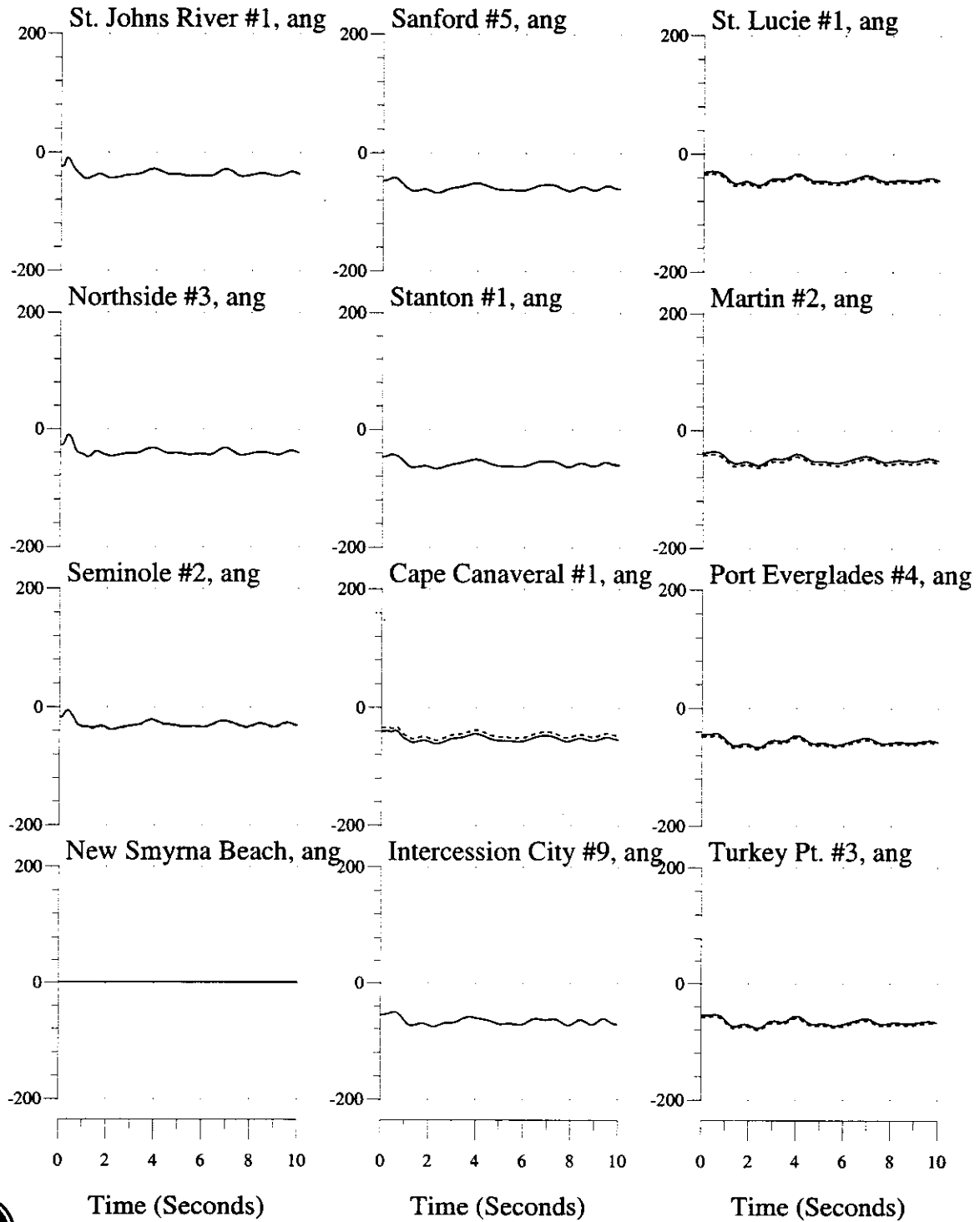

3-phase, 5-cycle Fault at Duval 500kV Bus, Trip Thalmann-Duval 500kV Line
 2003 Summer System

Bus Variables: (—) With Okeechobee No. FPL Dispatch, (...) Without

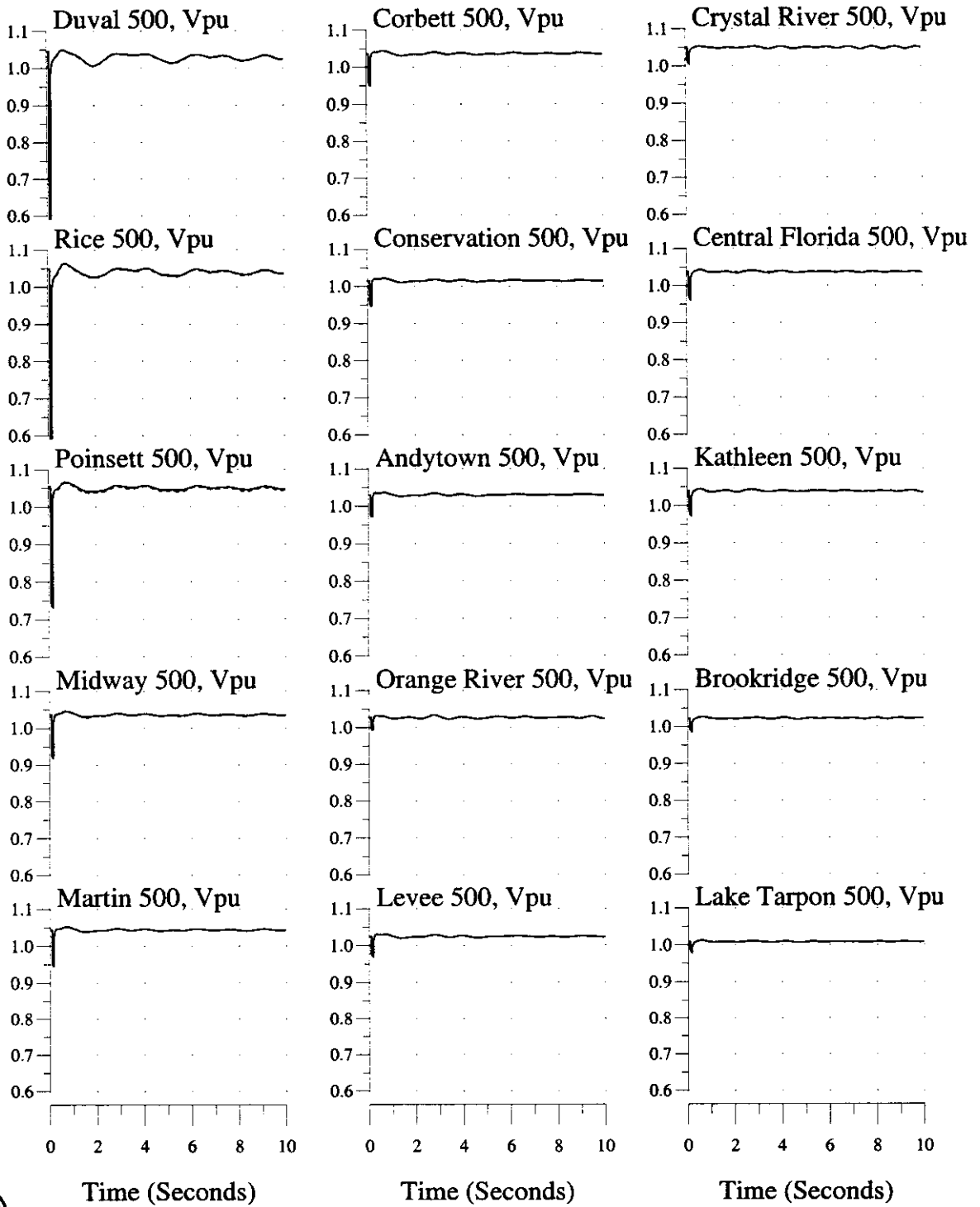

3-phase, 5-cycle Fault at Duval 500kV Bus, Trip Thalmann-Duval 500kV Line
2003 Summer System

Bus Variables: (—) With Okeechobee No. FPL Dispatch, (...) Without

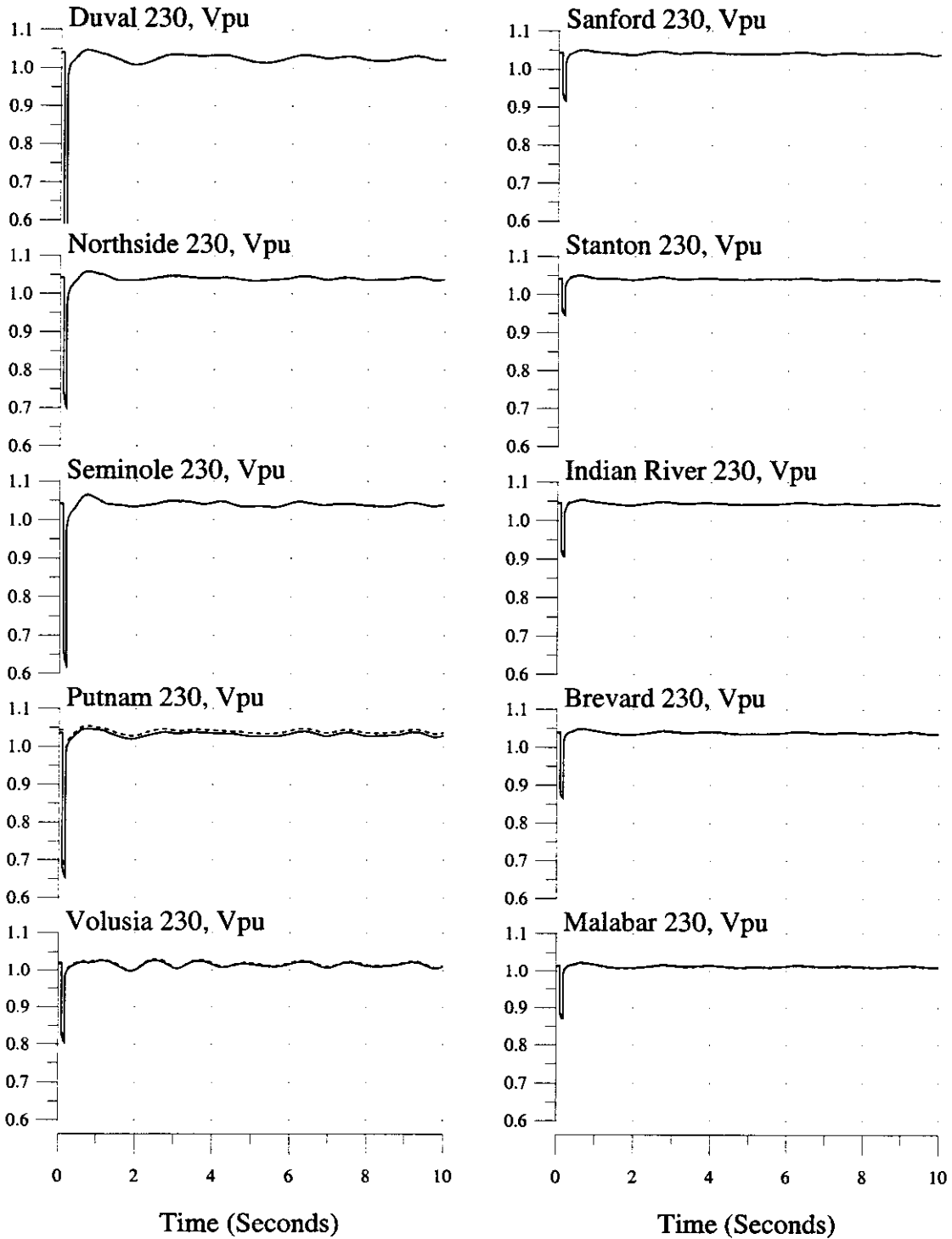

3-phase, 5-cycle Fault at Duval 500kV Bus, Trip Thalmann-Duval 500kV Line
2003 Summer System

Bus Variables: (—) With Okeechobee No. FPL Dispatch, (...) Without

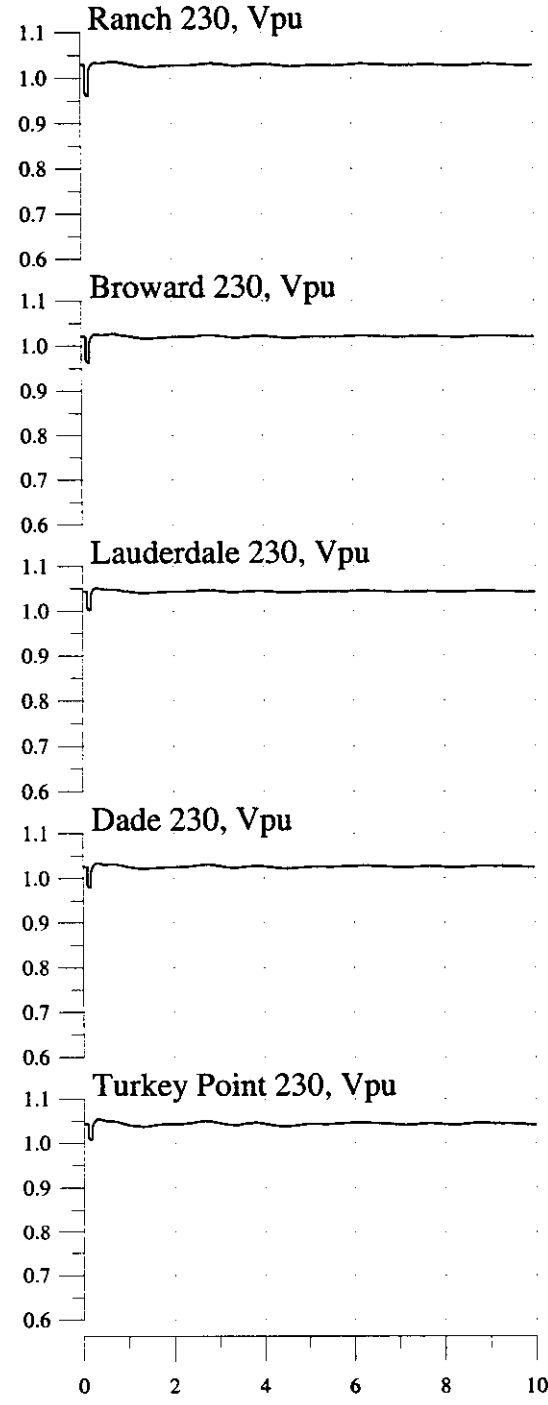
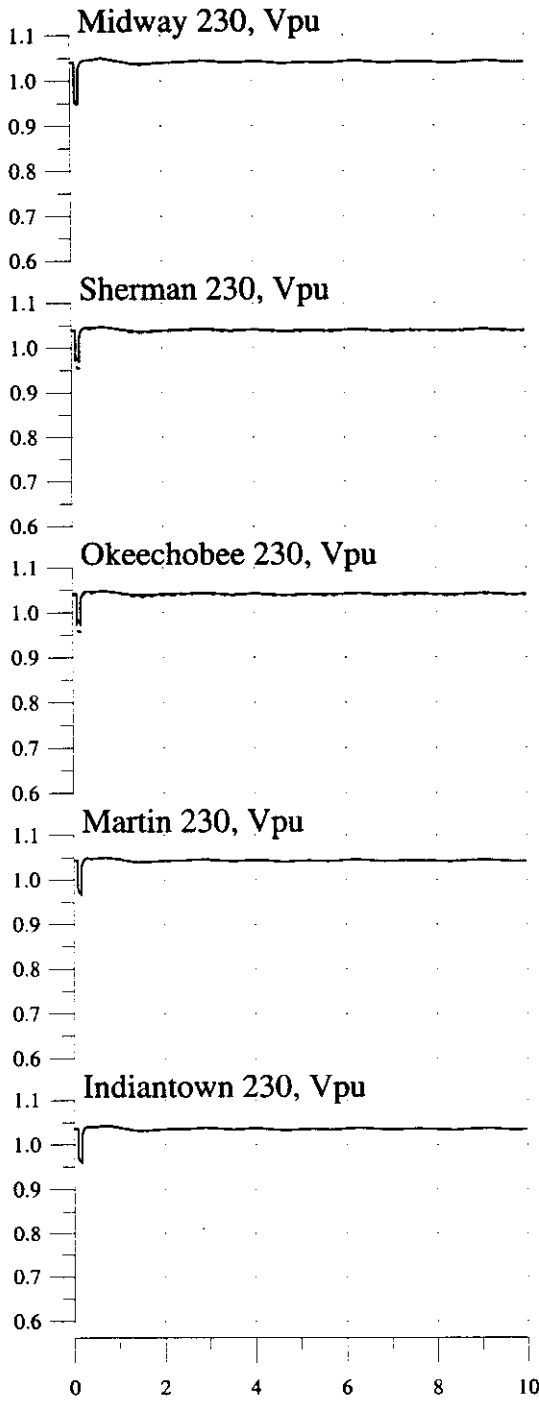

3-phase, 5-cycle Fault at Duval 500kV Bus, Trip Thalmann-Duval 500kV Line
2003 Summer System

Bus Variables: (___) With Okeechobee No. FPL Dispatch, (...) Without

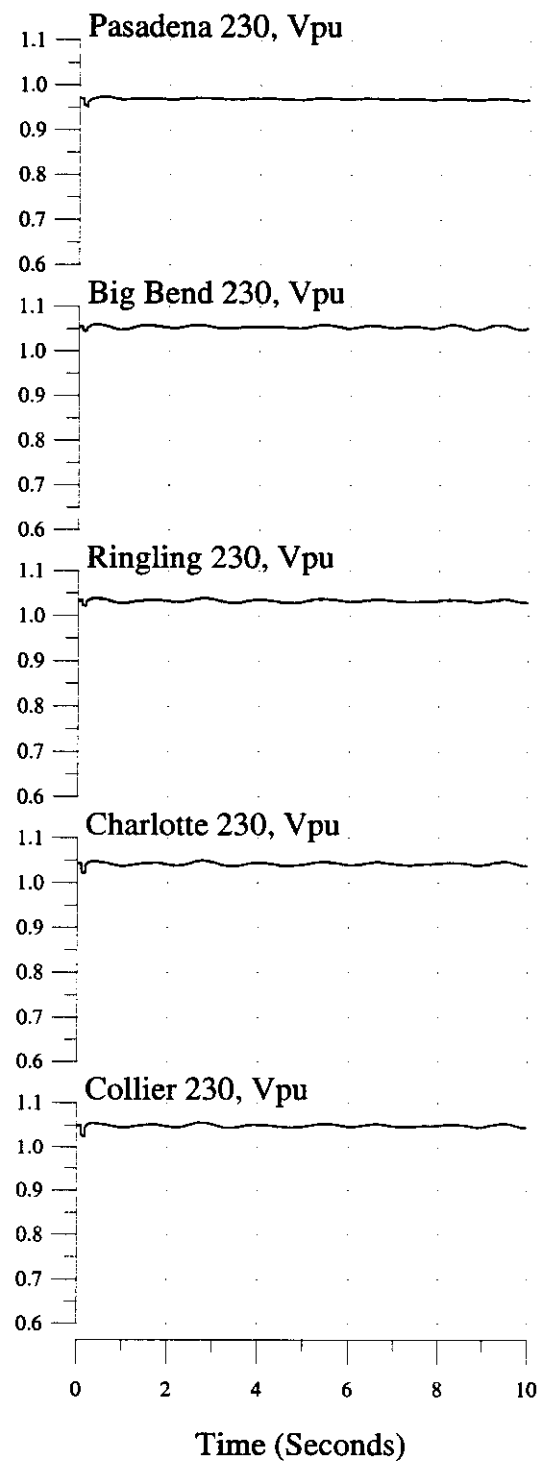
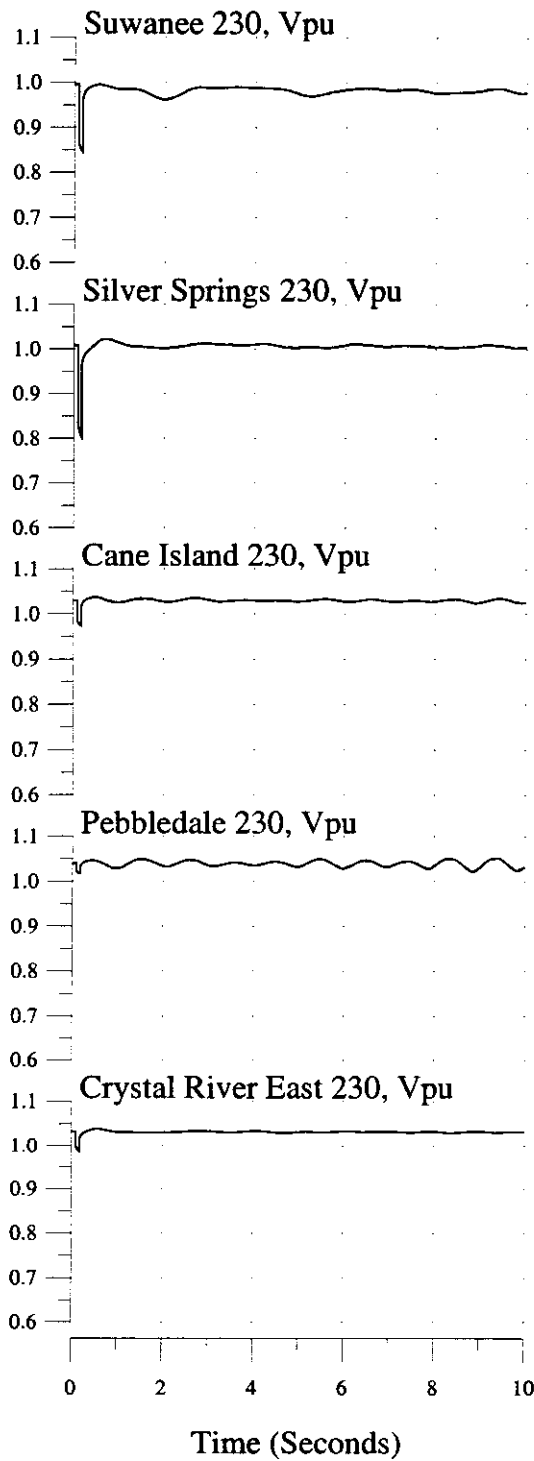

3-phase, 5-cycle Fault at Martin 500kV Bus, Trip Poinsett-Martin 500kV Line
2003 Summer System

Machine & Interface Variables: (___) With Okeechobee No. FPL Dispatch, (...) Without

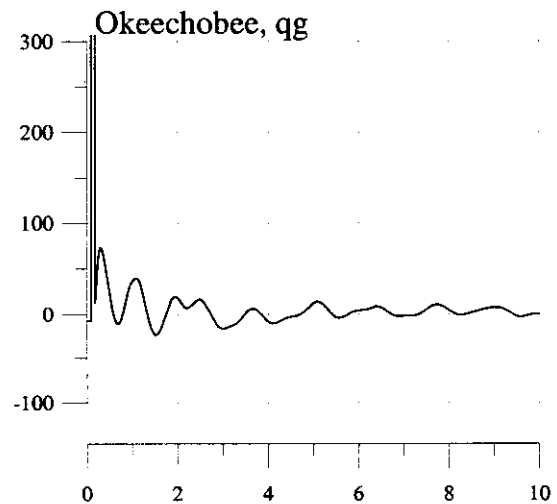
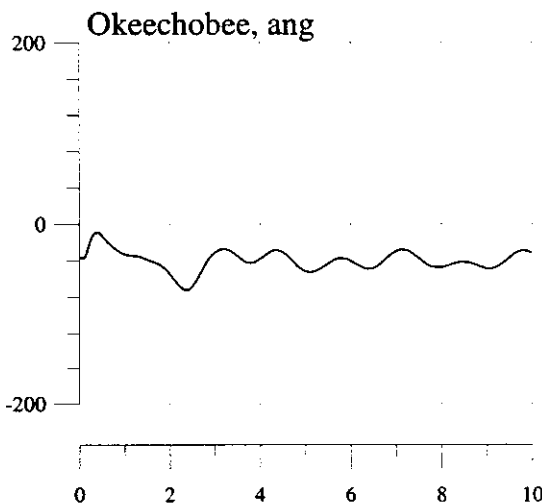
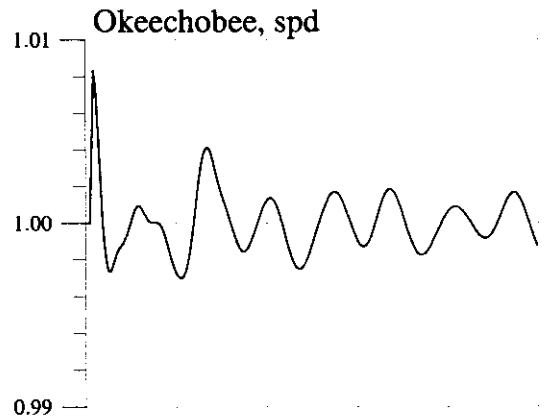
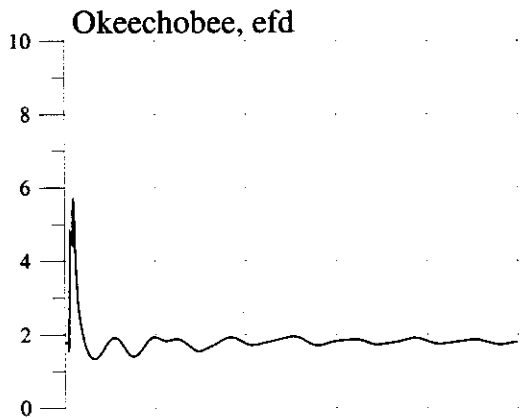
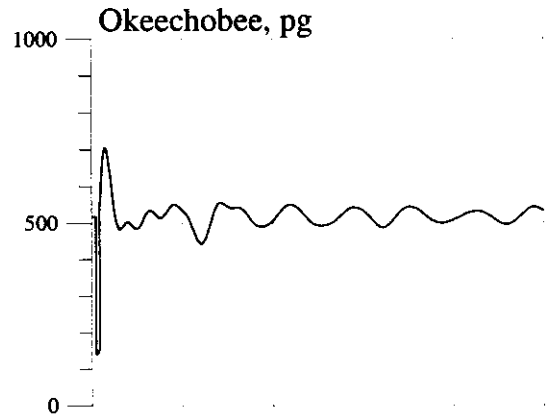
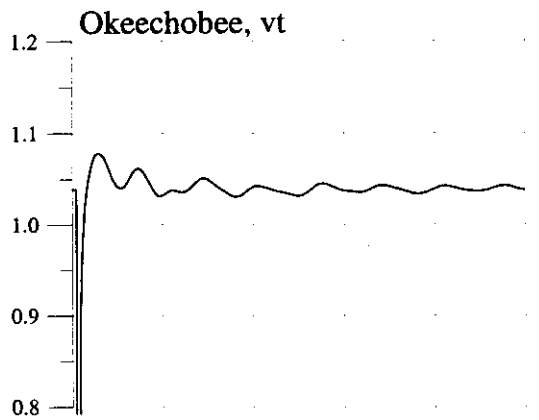

Time (Seconds)

Time (Seconds)



3-phase, 5-cycle Fault at Martin 500kV Bus, Trip Poinsett-Martin 500kV Line
2003 Summer System

Machine & Interface Variables: (—) With Okeechobee No. FPL Dispatch, (...) Without

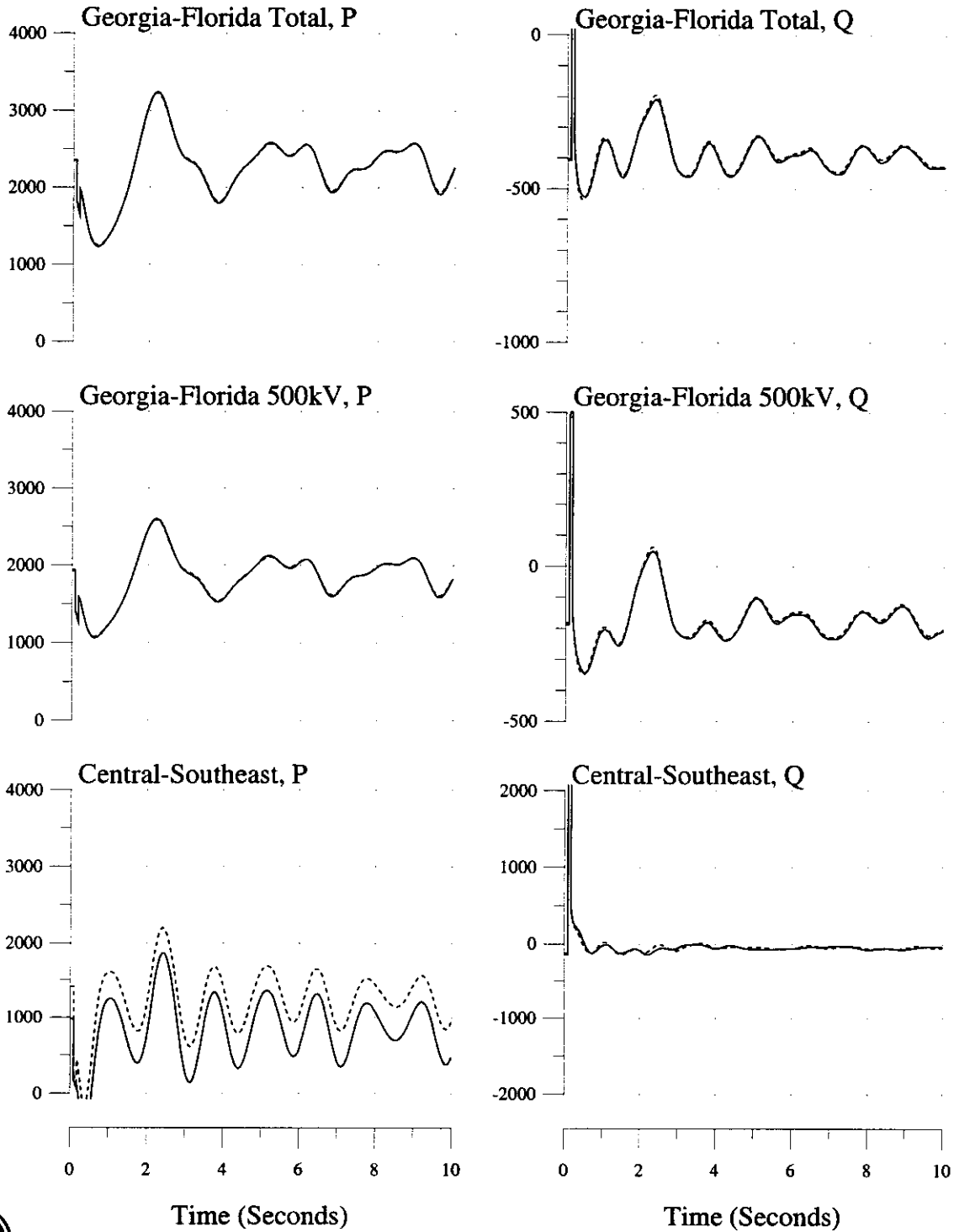

3-phase, 5-cycle Fault at Martin 500kV Bus, Trip Poinsett-Martin 500kV Line
2003 Summer System

Machine Variables: (___) With Okeechobee No. FPL Dispatch, (...) Without

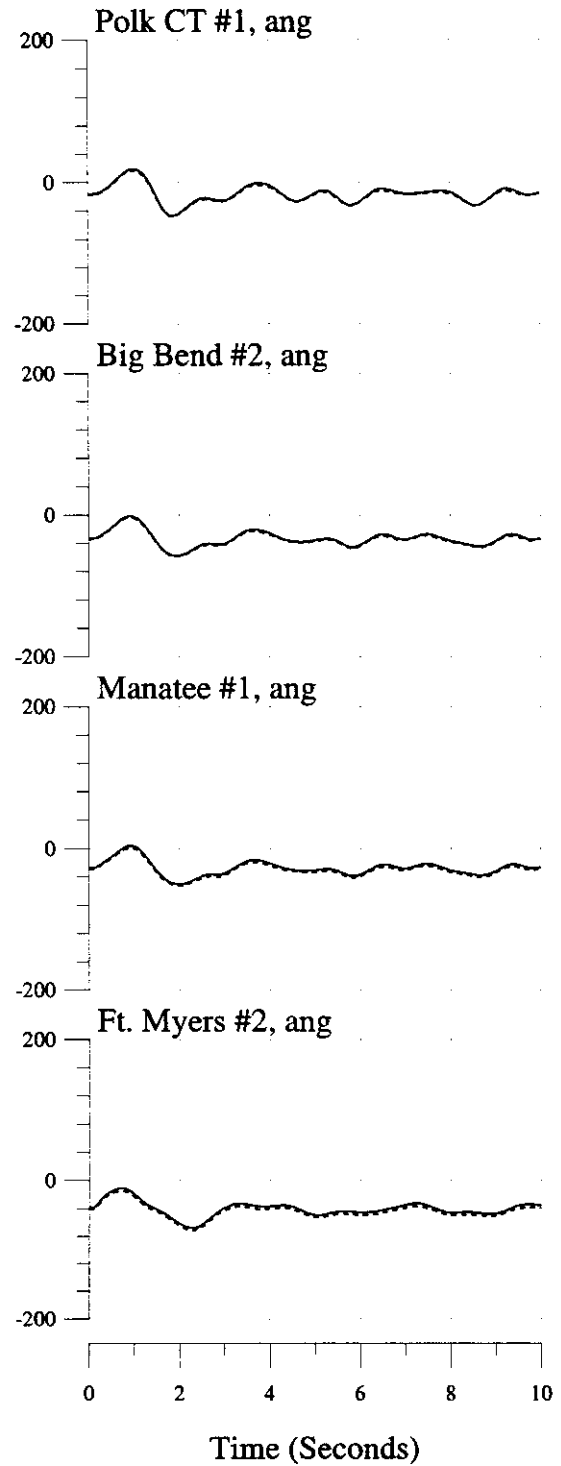
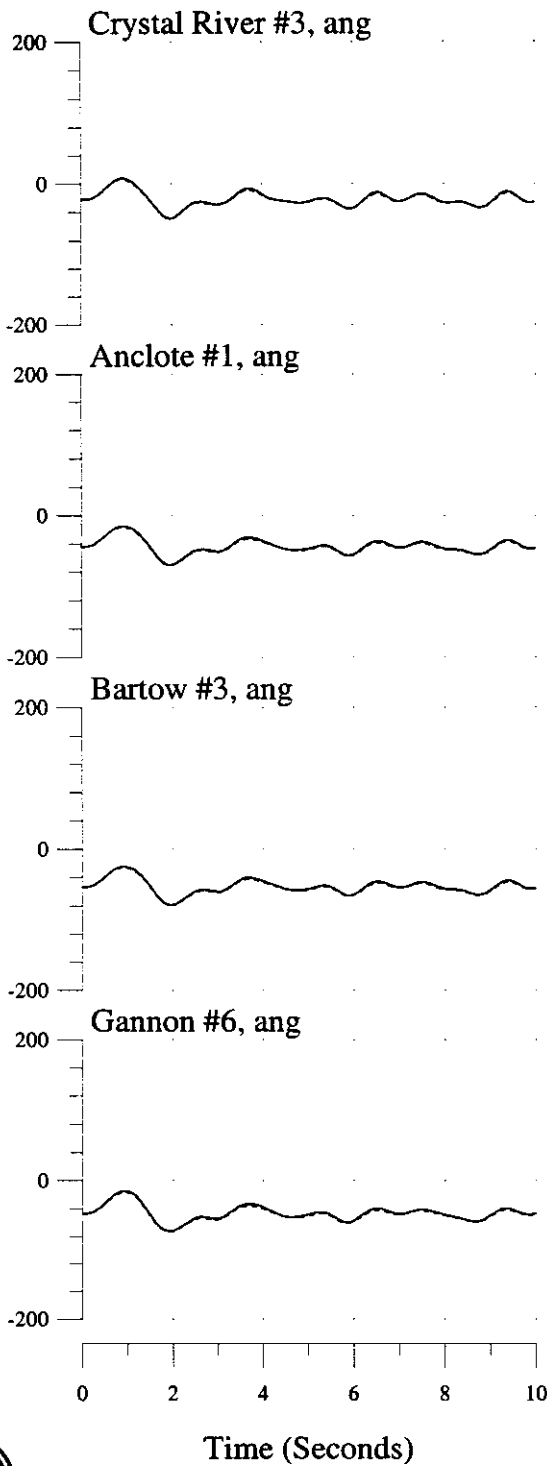

3-phase, 5-cycle Fault at Martin 500kV Bus, Trip Poinsett-Martin 500kV Line
 2003 Summer System

Machine Variables: (___) With Okeechobee No. FPL Dispatch, (...) Without

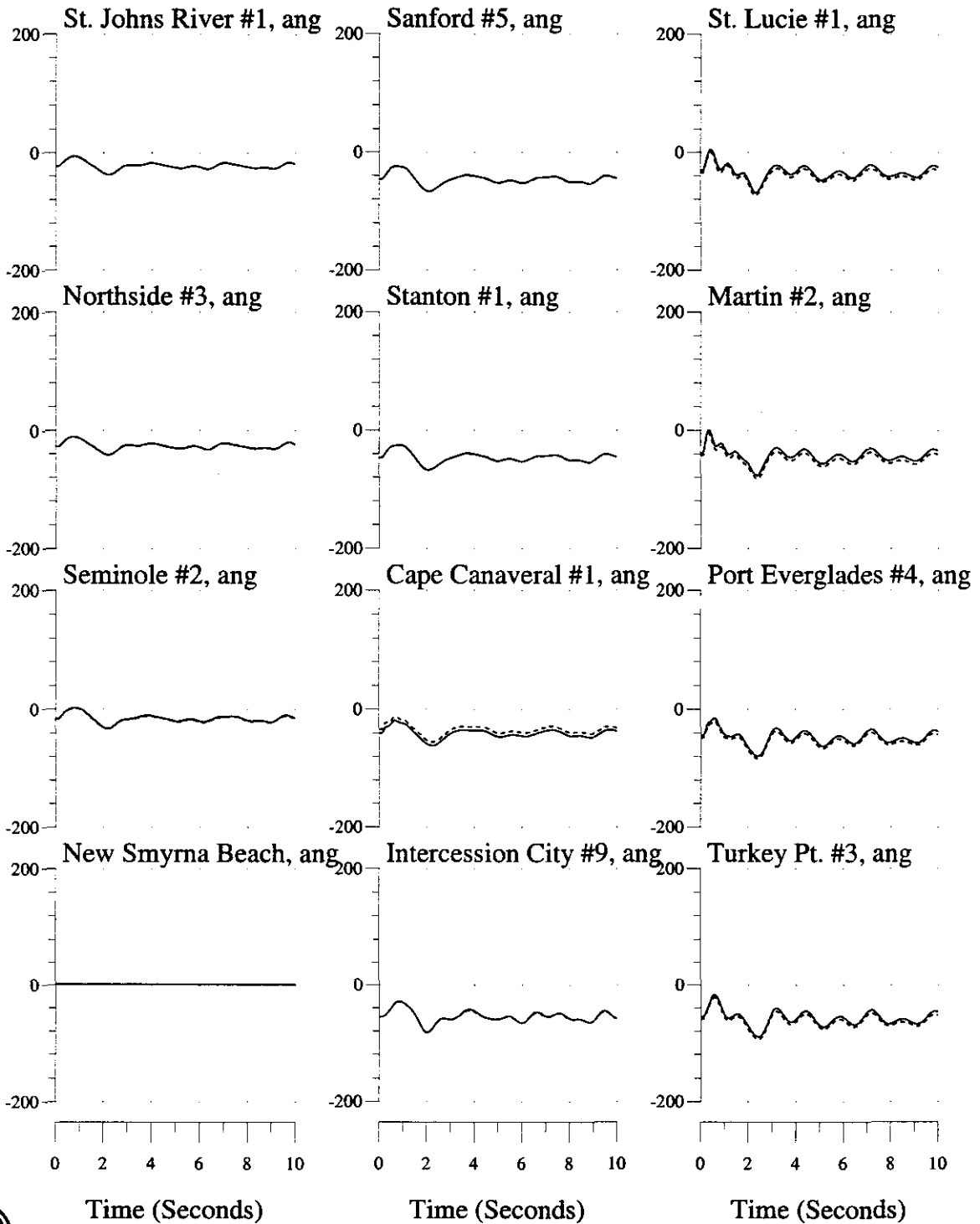

3-phase, 5-cycle Fault at Martin 500kV Bus, Trip Poinsett-Martin 500kV Line
 2003 Summer System

Bus Variables: (—) With Okeechobee No. FPL Dispatch, (...) Without

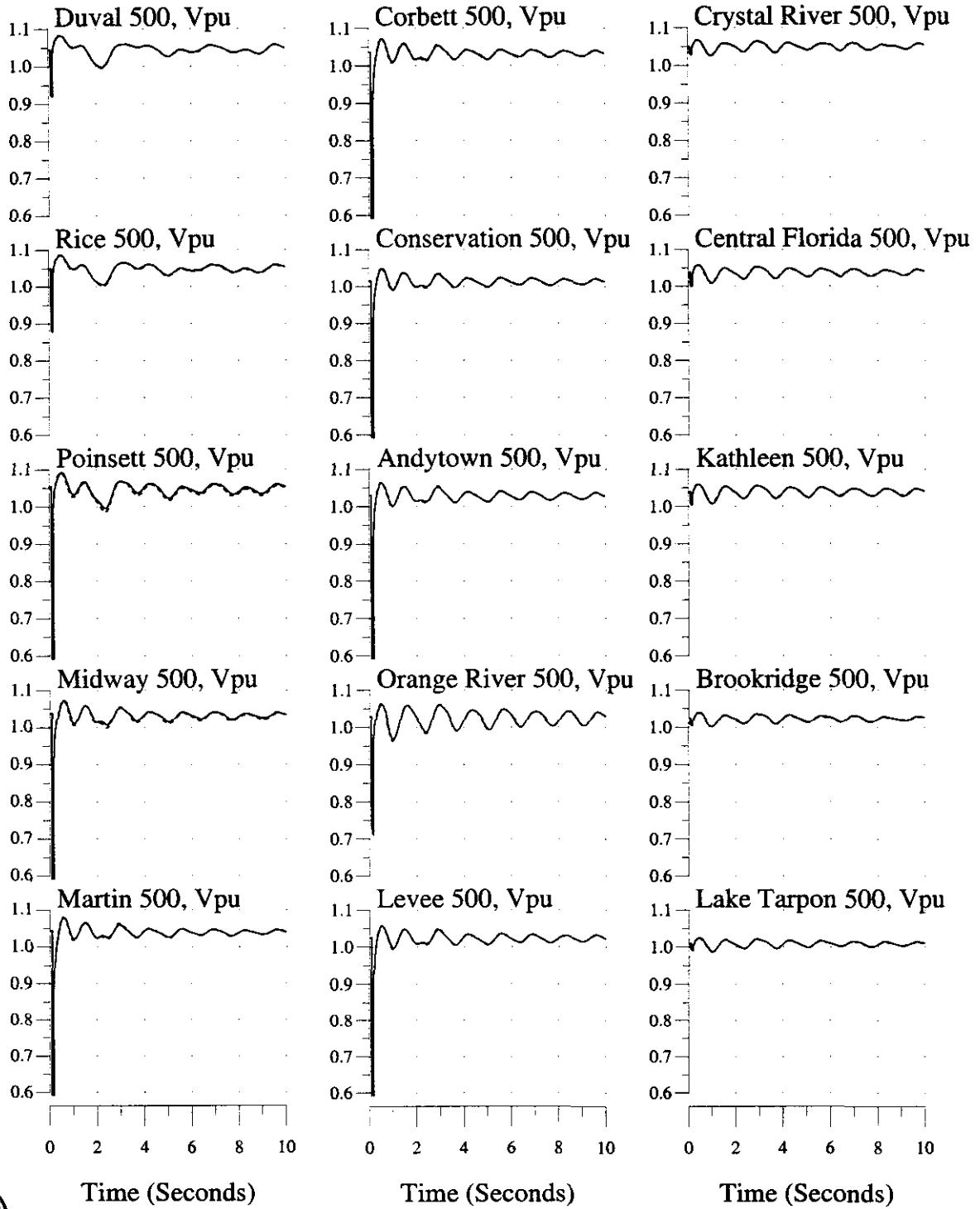

3-phase, 5-cycle Fault at Martin 500kV Bus, Trip Poinsett-Martin 500kV Line
2003 Summer System

Bus Variables: (___) With Okeechobee No. FPL Dispatch, (...) Without

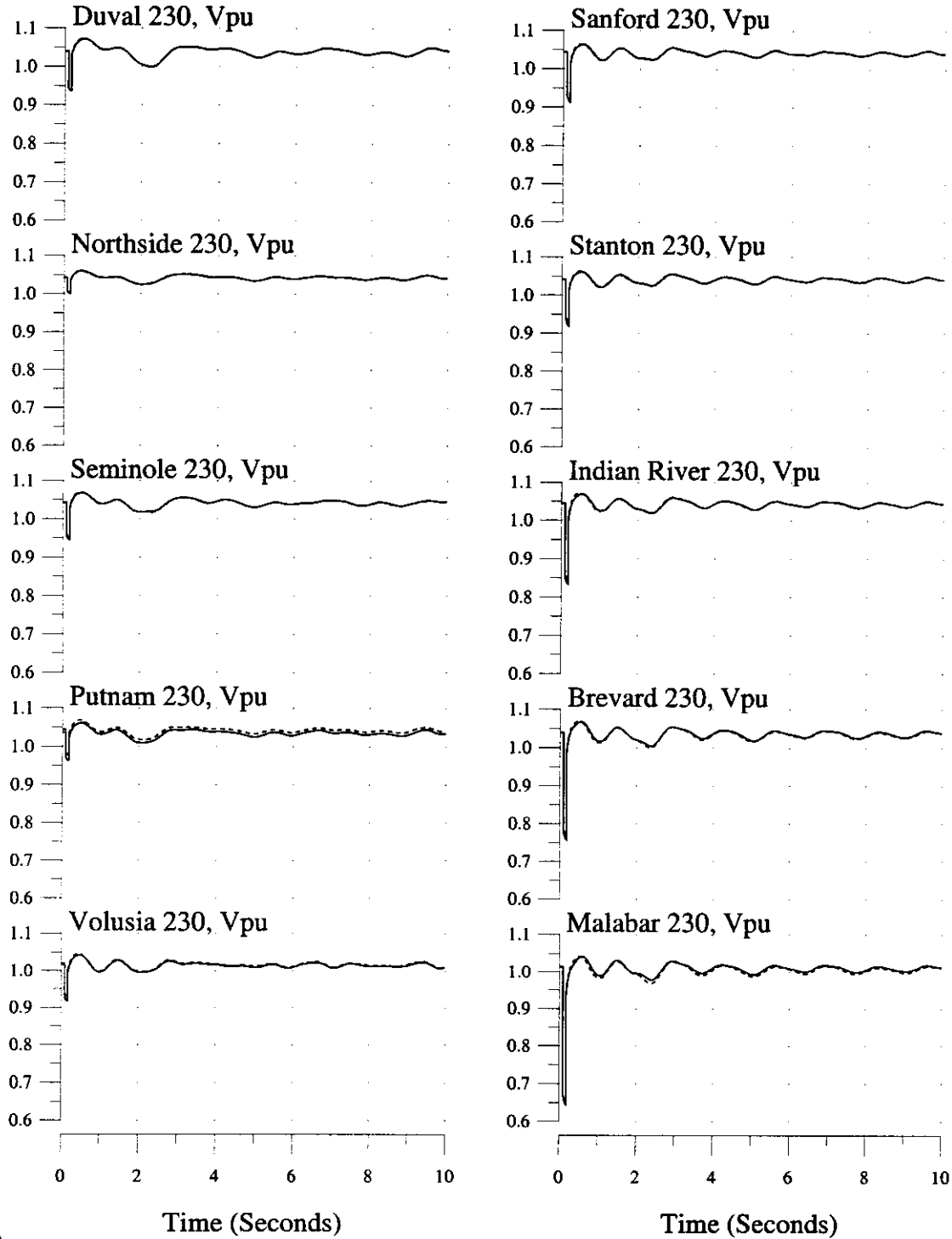

3-phase, 5-cycle Fault at Martin 500kV Bus, Trip Poinsett-Martin 500kV Line
2003 Summer System

Bus Variables: (___) With Okeechobee No. FPL Dispatch, (...) Without

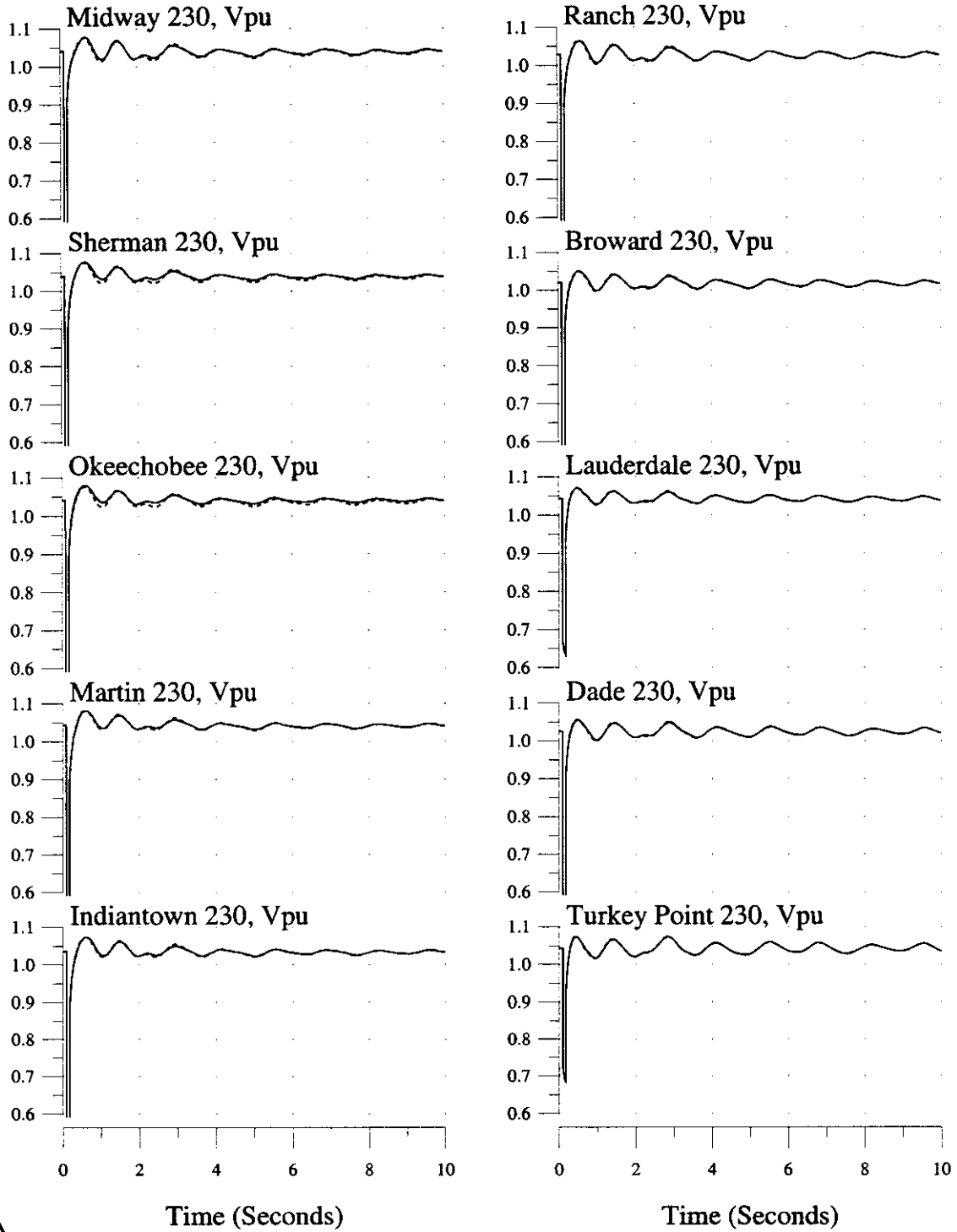

3-phase, 5-cycle Fault at Martin 500kV Bus, Trip Poinsett-Martin 500kV Line
2003 Summer System

Bus Variables: (—) With Okeechobee No. FPL Dispatch, (...) Without

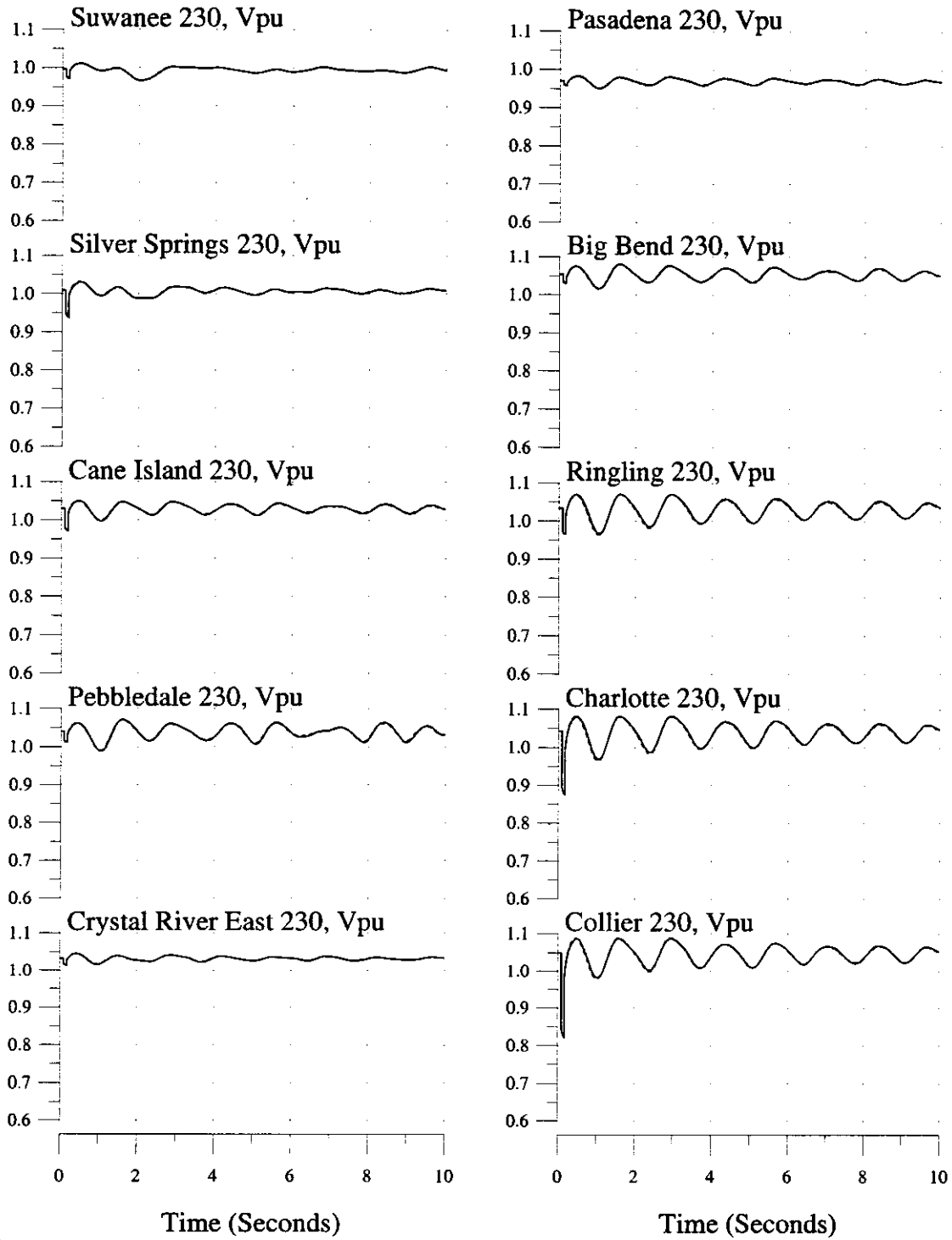

3-phase, 5-cycle Fault at Okeechobee 230kV Bus, Trip Okeechobee-Sherman 230kV Line
2003 Summer System

Machine & Interface Variables: (—) With Okeechobee No. FPL Dispatch, (...) Without

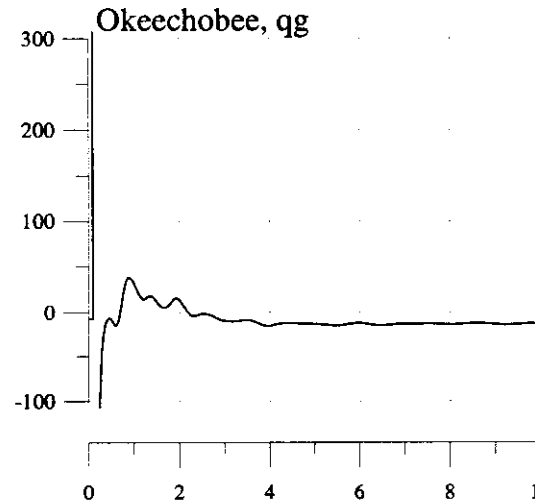
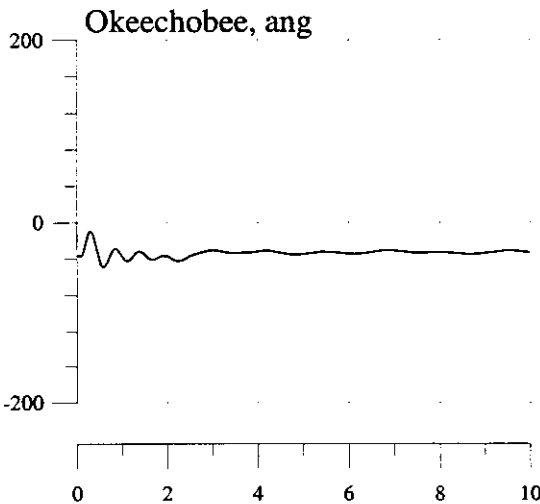
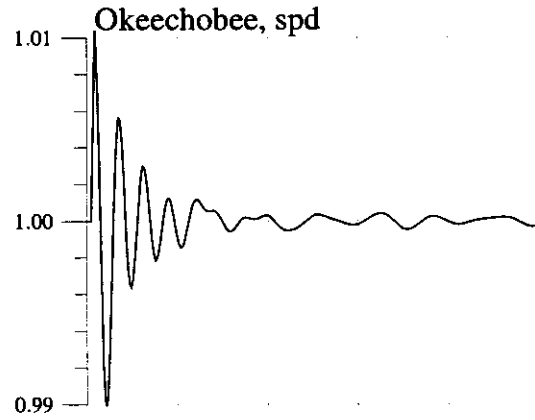
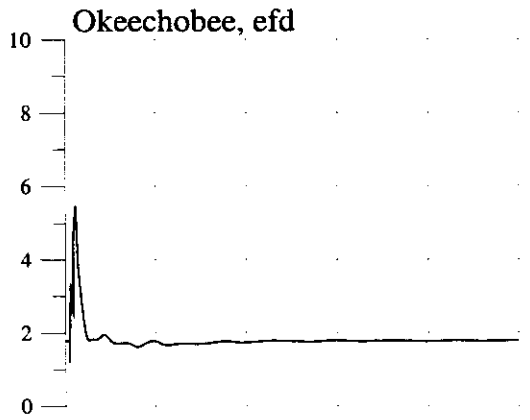
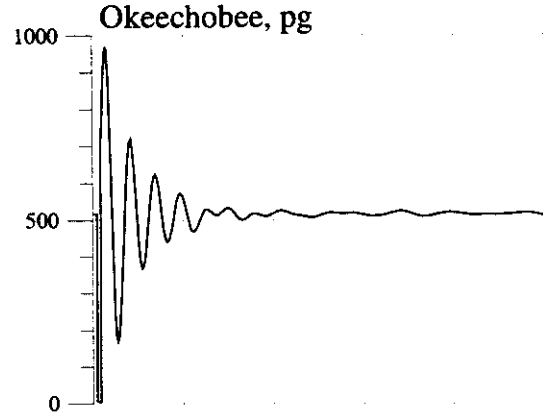
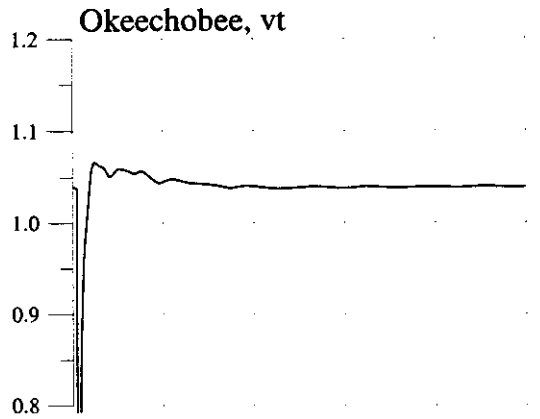

Time (Seconds)

Time (Seconds)



3-phase, 5-cycle Fault at Okeechobee 230kV Bus, Trip Okeechobee-Sherman 230kV Line
 2003 Summer System

Machine & Interface Variables: (—) With Okeechobee No. FPL Dispatch, (...) Without

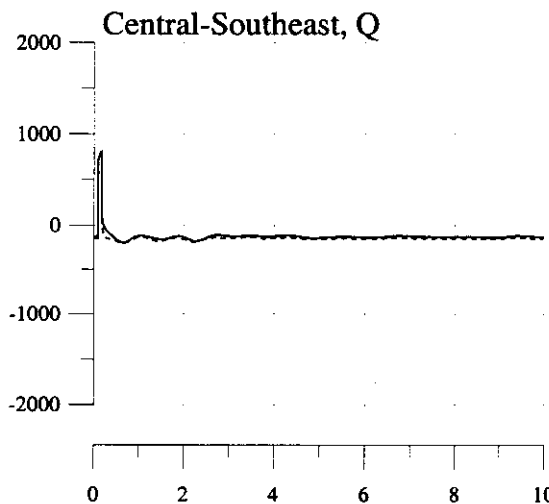
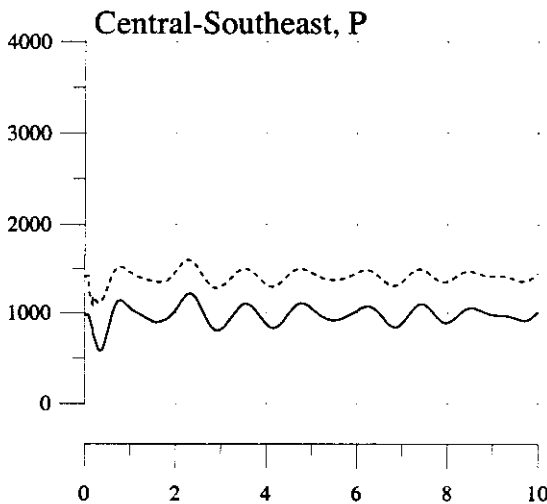
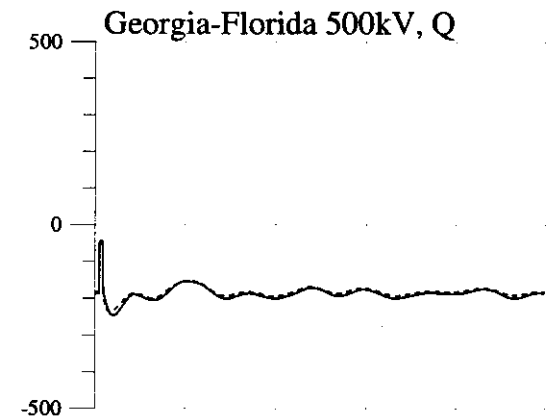
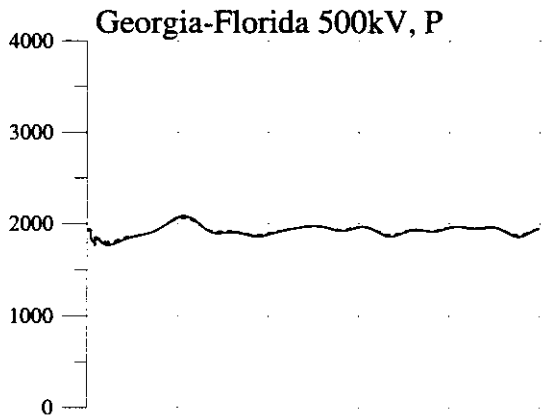
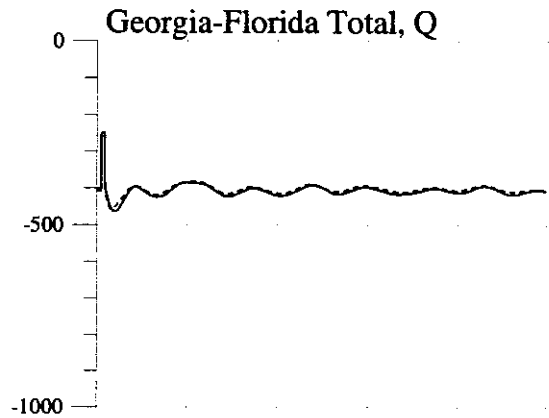
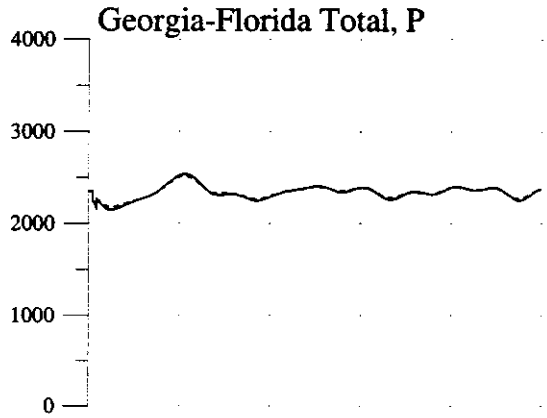

Time (Seconds)

Time (Seconds)



3-phase, 5-cycle Fault at Okeechobee 230kV Bus, Trip Okeechobee-Sherman 230kV Line
2003 Summer System

Machine Variables: (___) With Okeechobee No. FPL Dispatch, (...) Without

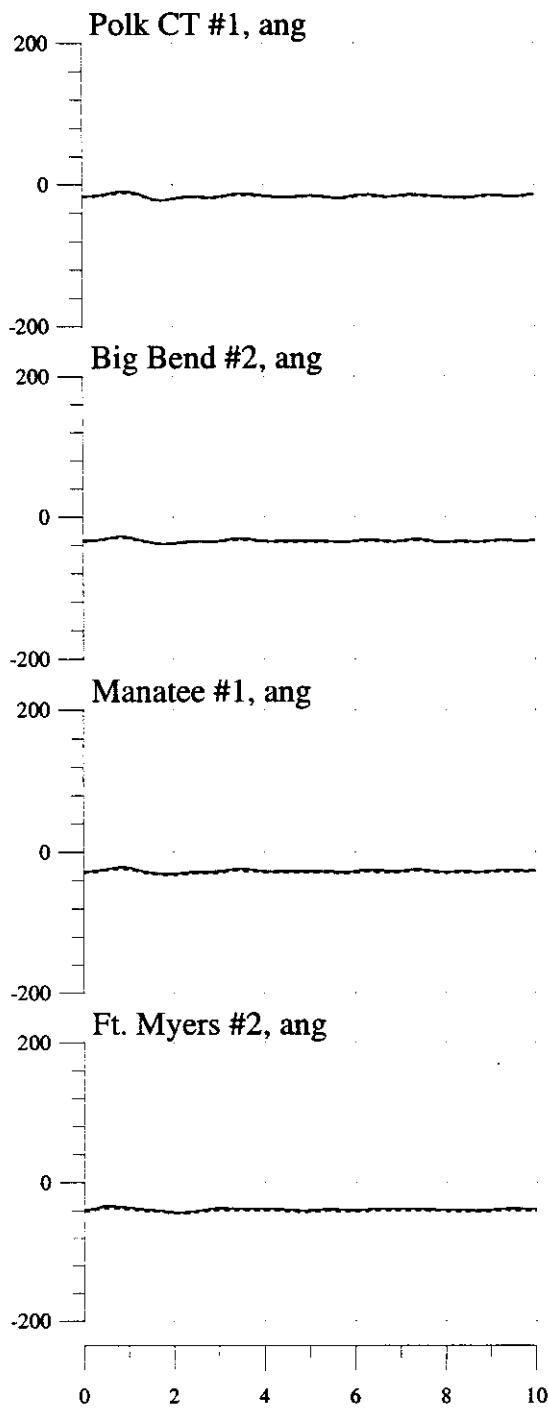
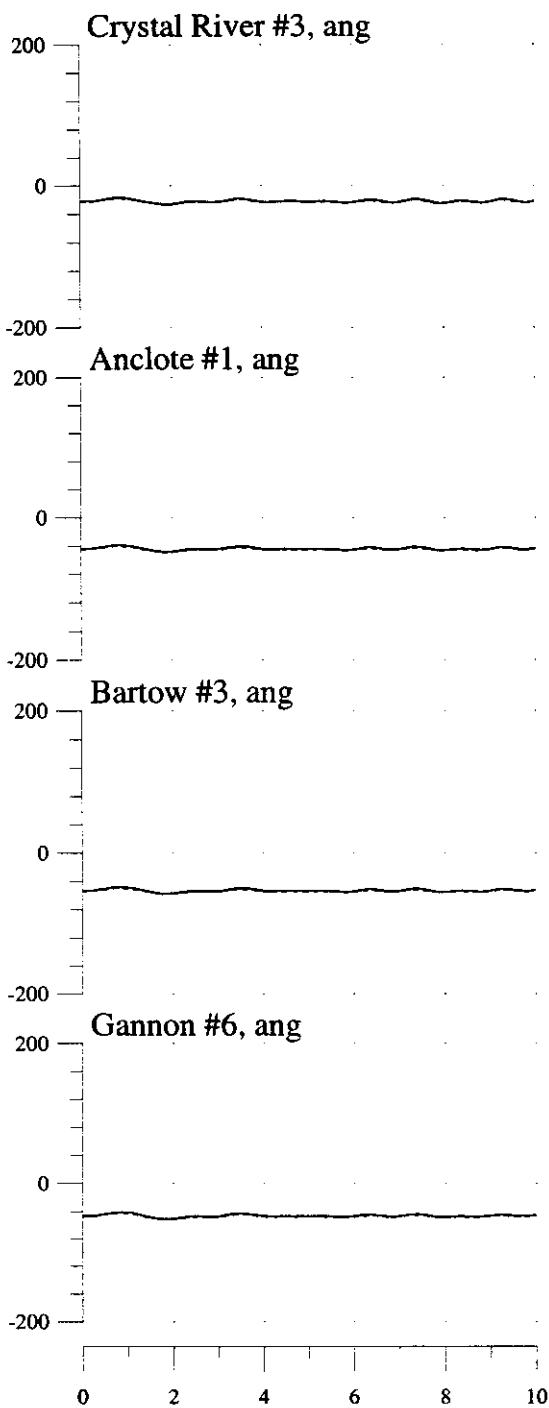

3-phase, 5-cycle Fault at Okeechobee 230kV Bus, Trip Okeechobee-Sherman 230kV Line
 2003 Summer System

Machine Variables: (—) With Okeechobee No. FPL Dispatch, (...) Without

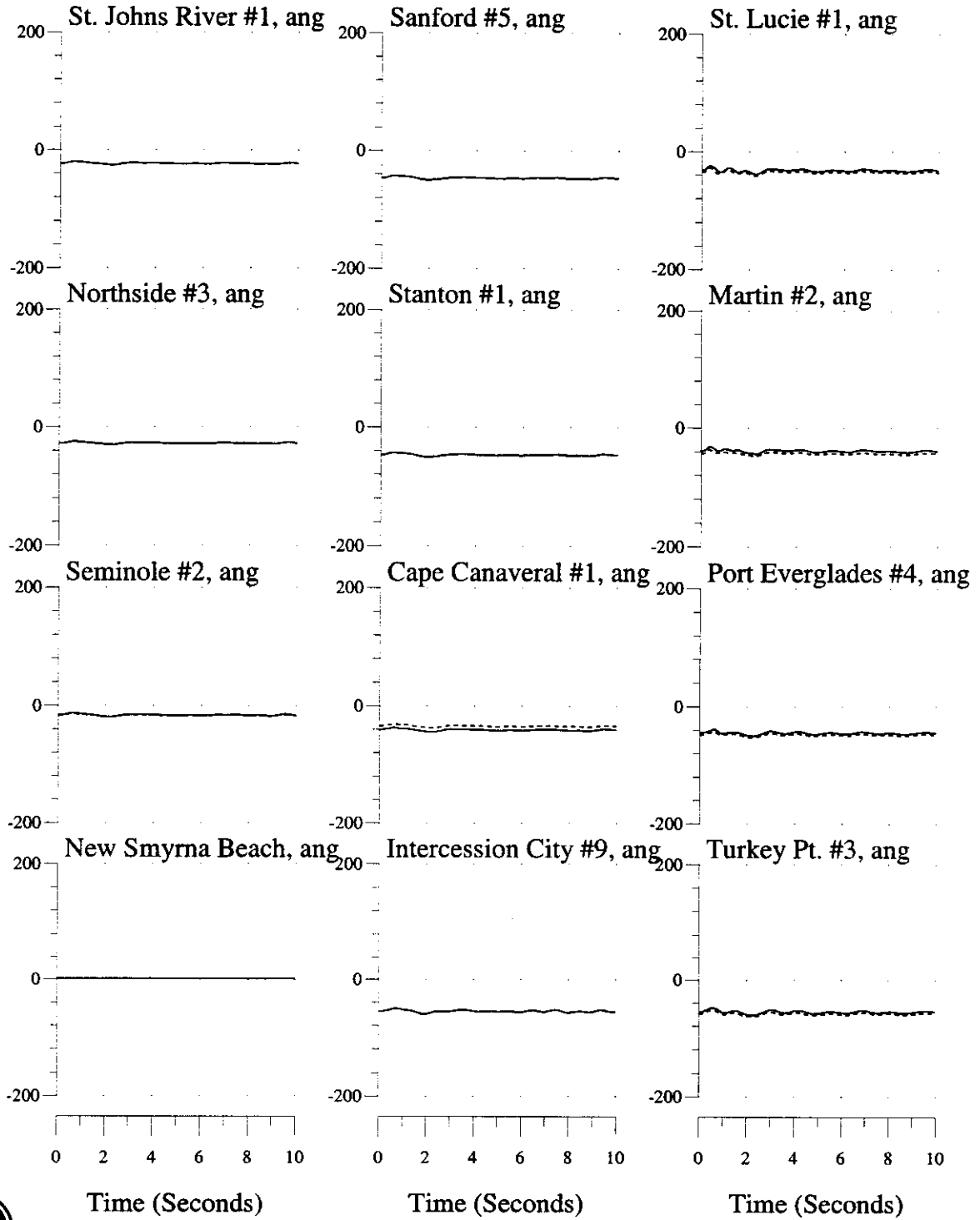

3-phase, 5-cycle Fault at Okeechobee 230kV Bus, Trip Okeechobee-Sherman 230kV Line
2003 Summer System

Bus Variables: (___) With Okeechobee No. FPL Dispatch, (...) Without

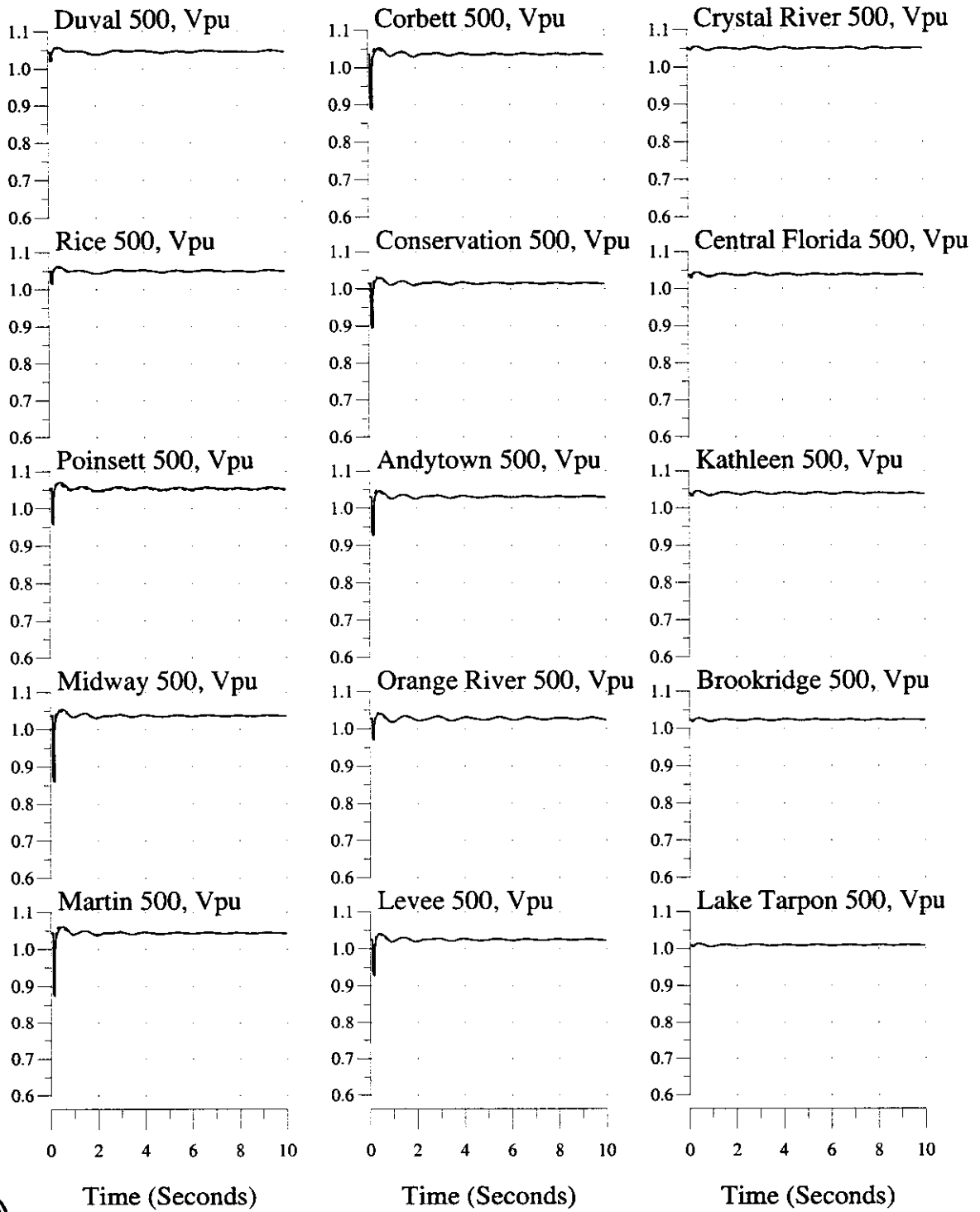

3-phase, 5-cycle Fault at Okeechobee 230kV Bus, Trip Okeechobee-Sherman 230kV Line
 2003 Summer System

Bus Variables: (___) With Okeechobee No. FPL Dispatch, (...) Without

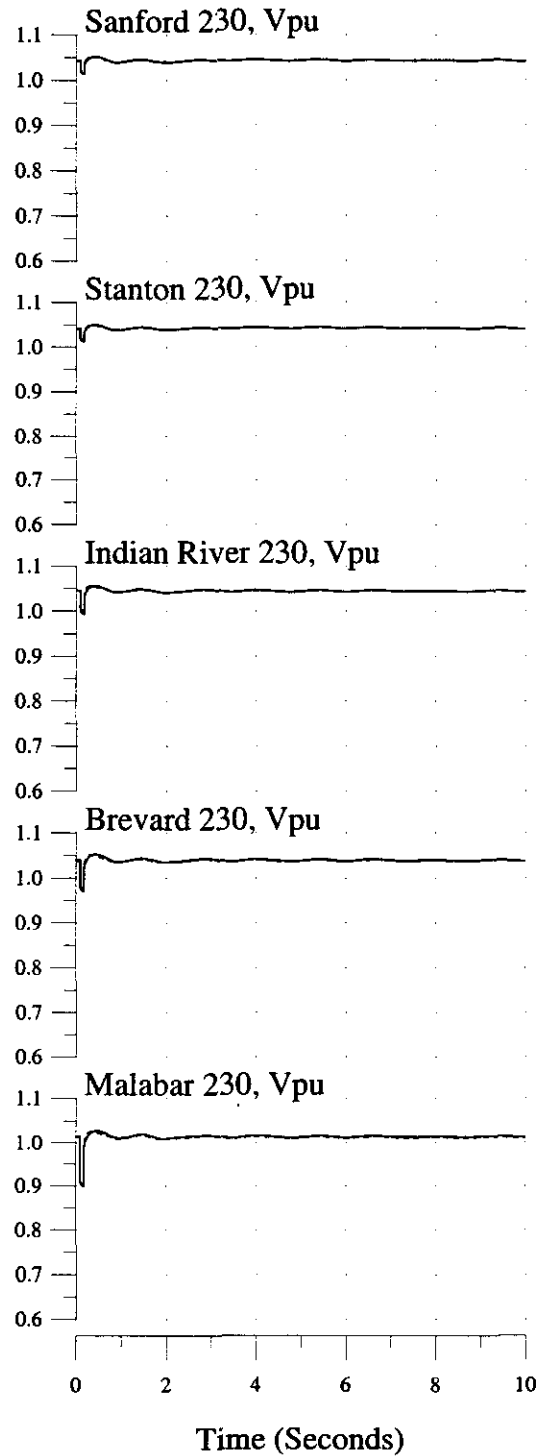
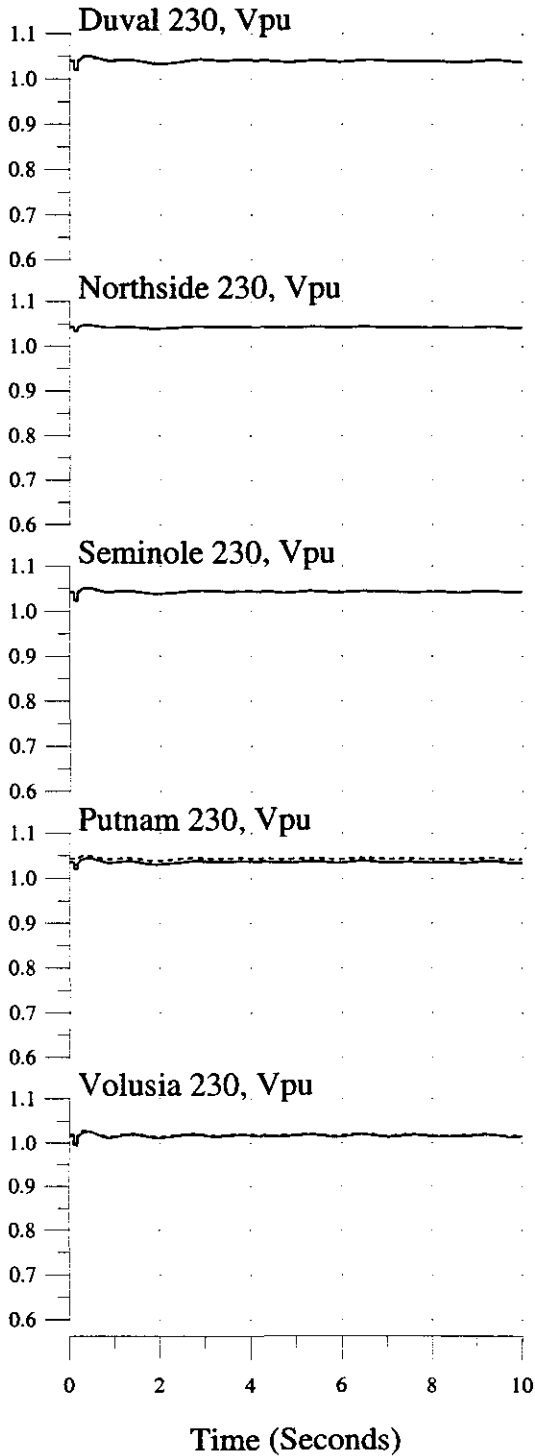

3-phase, 5-cycle Fault at Okeechobee 230kV Bus, Trip Okeechobee-Sherman 230kV Line
2003 Summer System

Bus Variables: (___) With Okeechobee No. FPL Dispatch, (...) Without

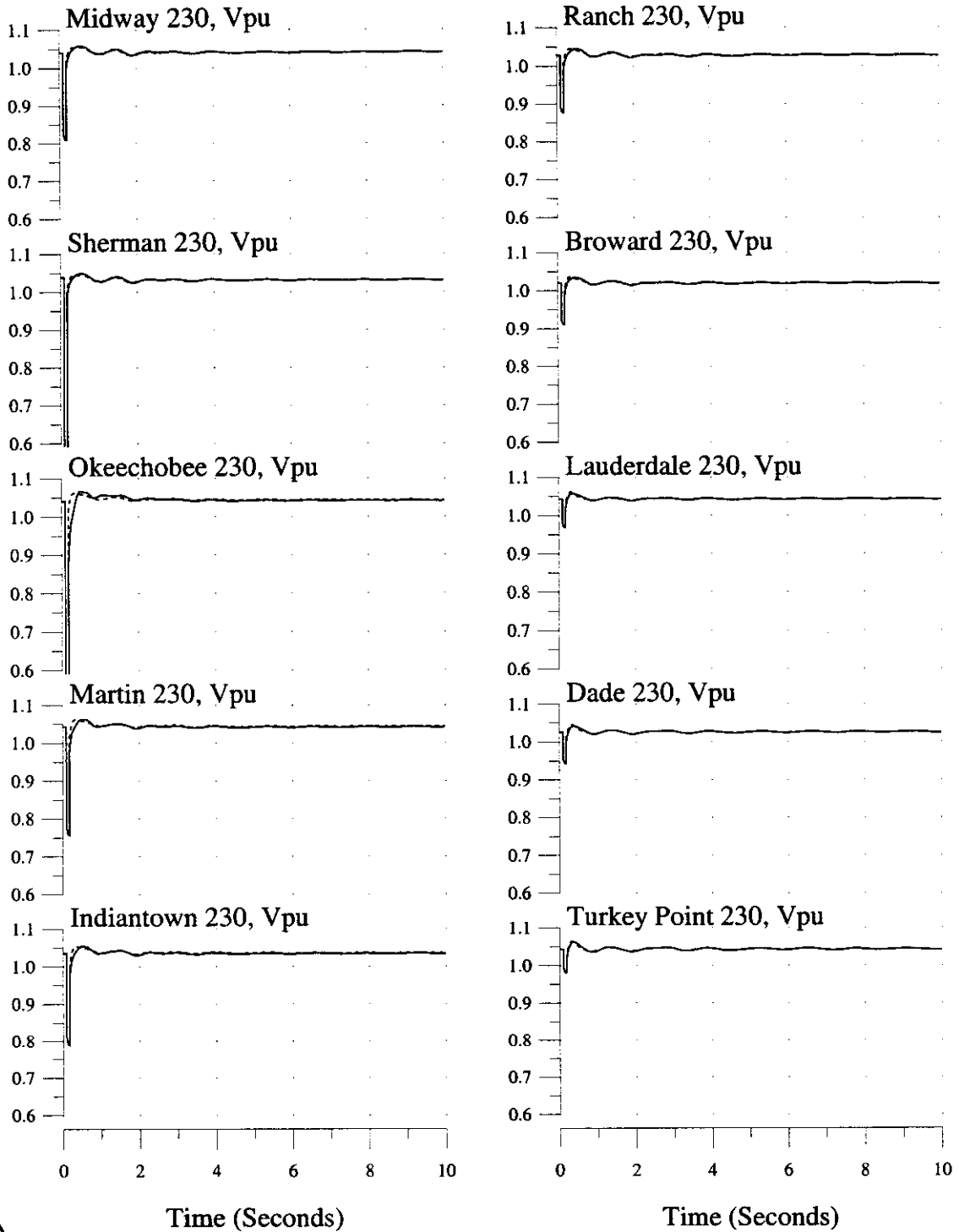

3-phase, 5-cycle Fault at Okeechobee 230kV Bus, Trip Okeechobee-Sherman 230kV Line
 2003 Summer System

Bus Variables: (—) With Okeechobee No. FPL Dispatch, (...) Without

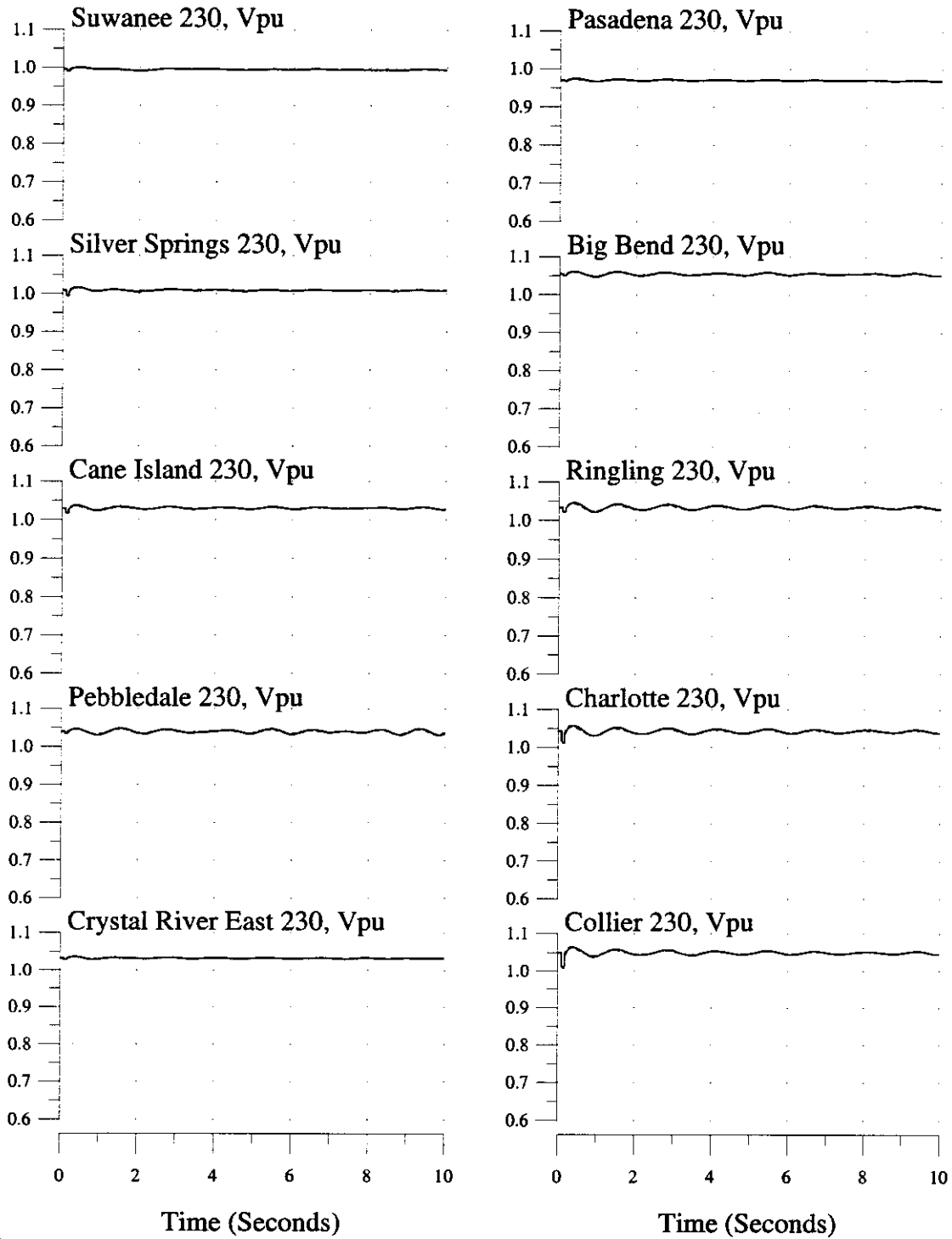

3-phase, 5-cycle Fault at Okeechobee 230kV Bus, Trip Okeechobee-Martin 230kV Line
2003 Summer System

Machine & Interface Variables: (___) With Okeechobee No. FPL Dispatch, (...) Without

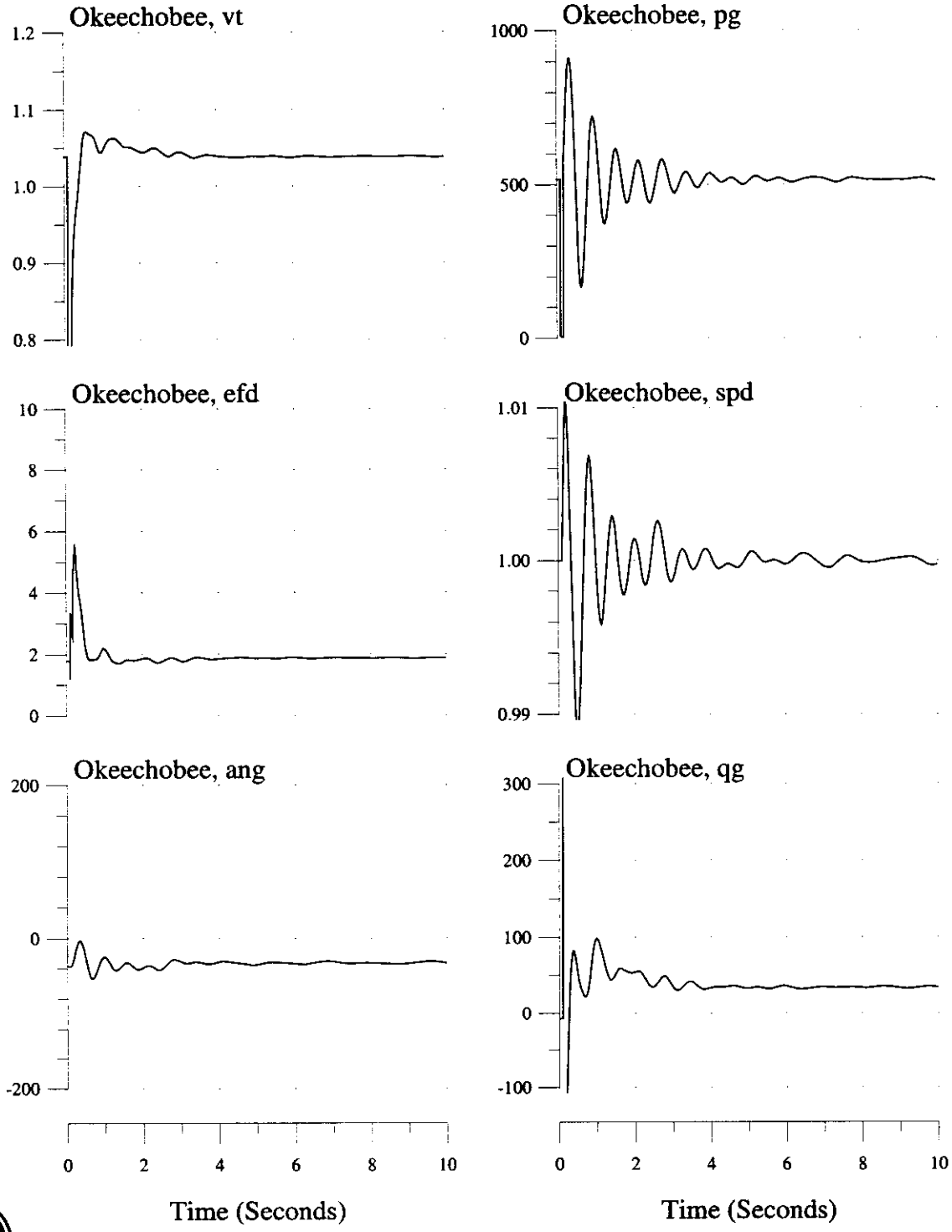

3-phase, 5-cycle Fault at Okeechobee 230kV Bus, Trip Okeechobee-Martin 230kV Line
 2003 Summer System

Machine & Interface Variables: (—) With Okeechobee No. FPL Dispatch, (...) Without

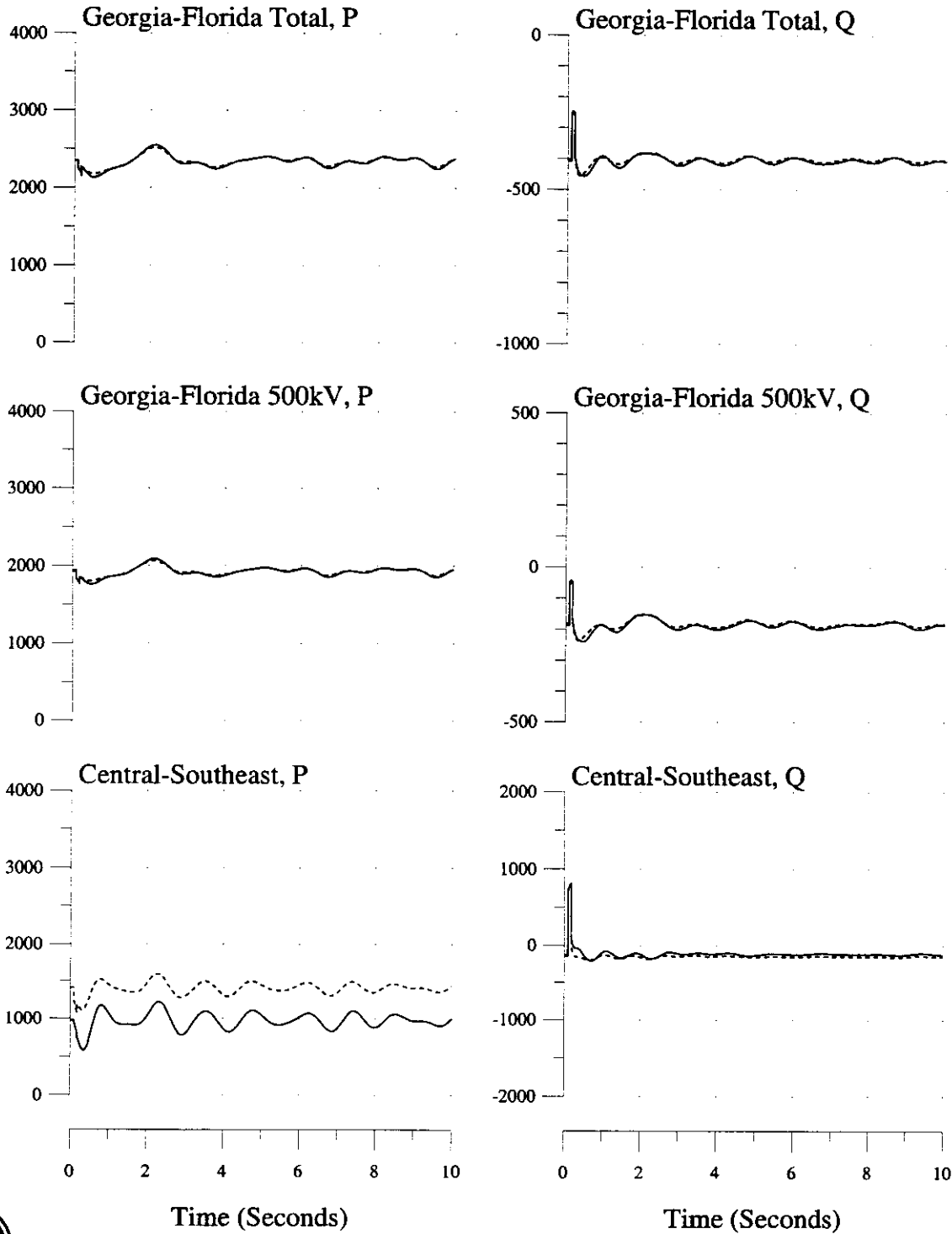

3-phase, 5-cycle Fault at Okeechobee 230kV Bus, Trip Okeechobee-Martin 230kV Line
2003 Summer System

Machine Variables: (___) With Okeechobee No. FPL Dispatch, (...) Without

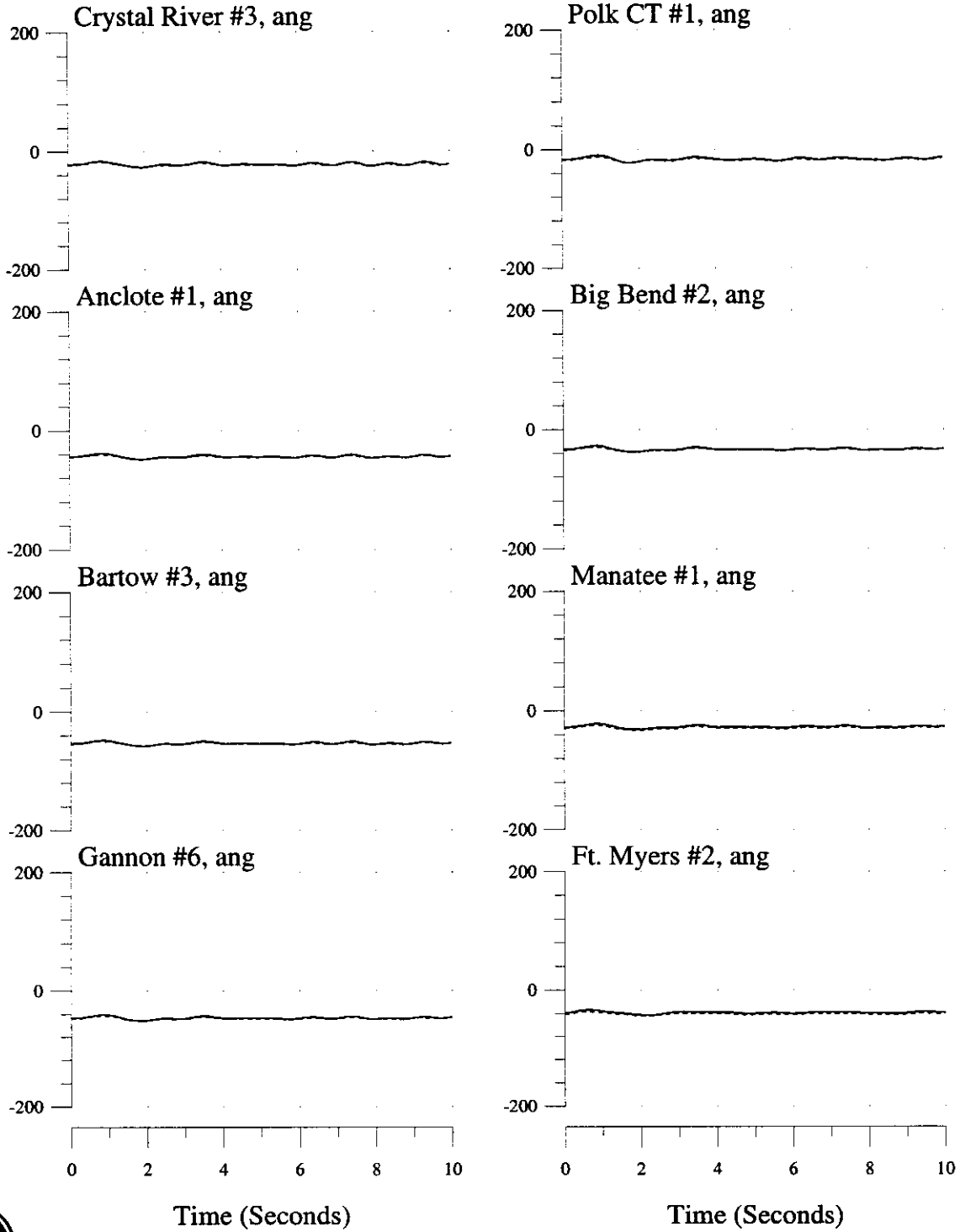

3-phase, 5-cycle Fault at Okeechobee 230kV Bus, Trip Okeechobee-Martin 230kV Line
2003 Summer System

Machine Variables: (—) With Okeechobee No. FPL Dispatch, (...) Without

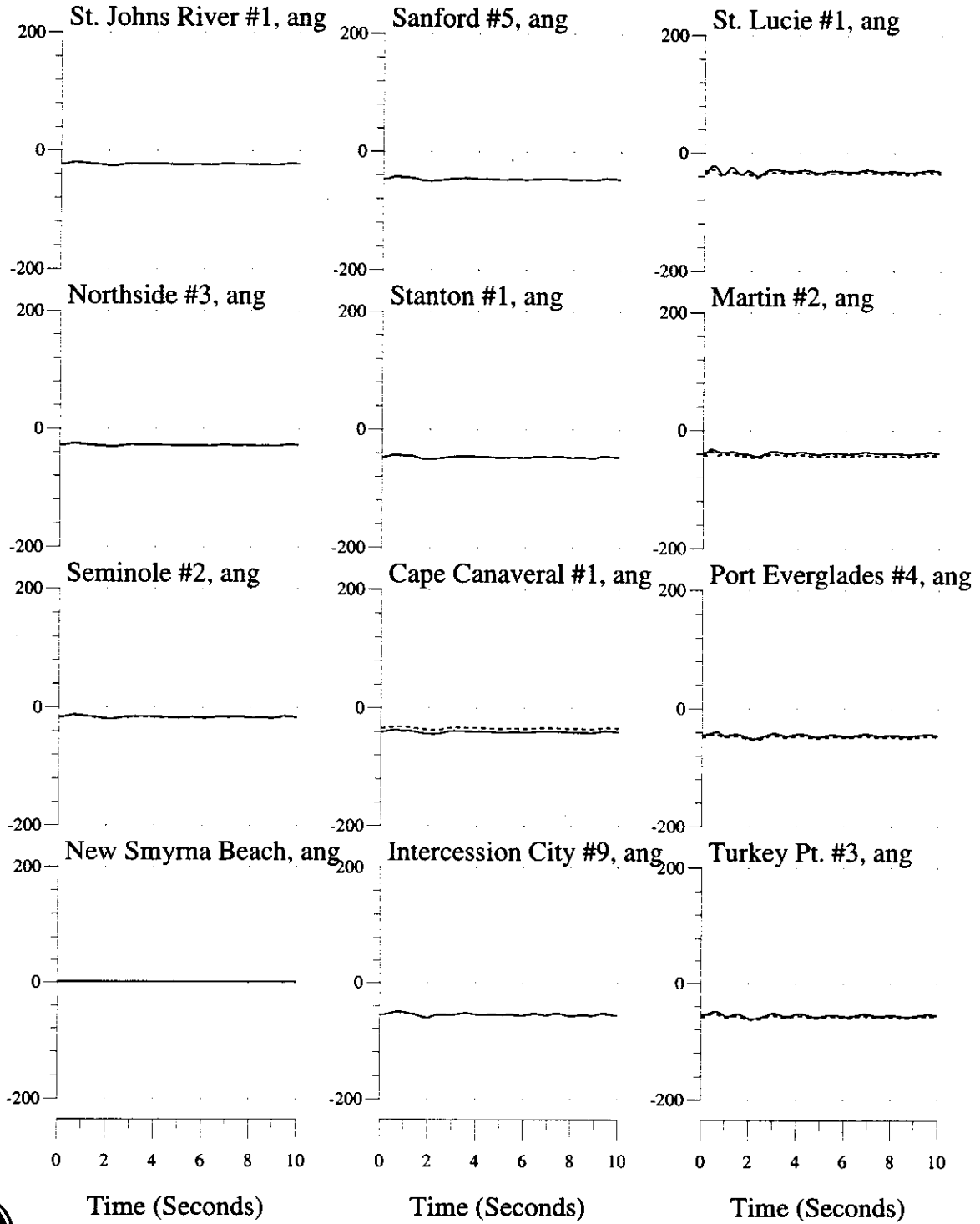

3-phase, 5-cycle Fault at Okeechobee 230kV Bus, Trip Okeechobee-Martin 230kV Line
 2003 Summer System

Bus Variables: (___) With Okeechobee No. FPL Dispatch, (...) Without

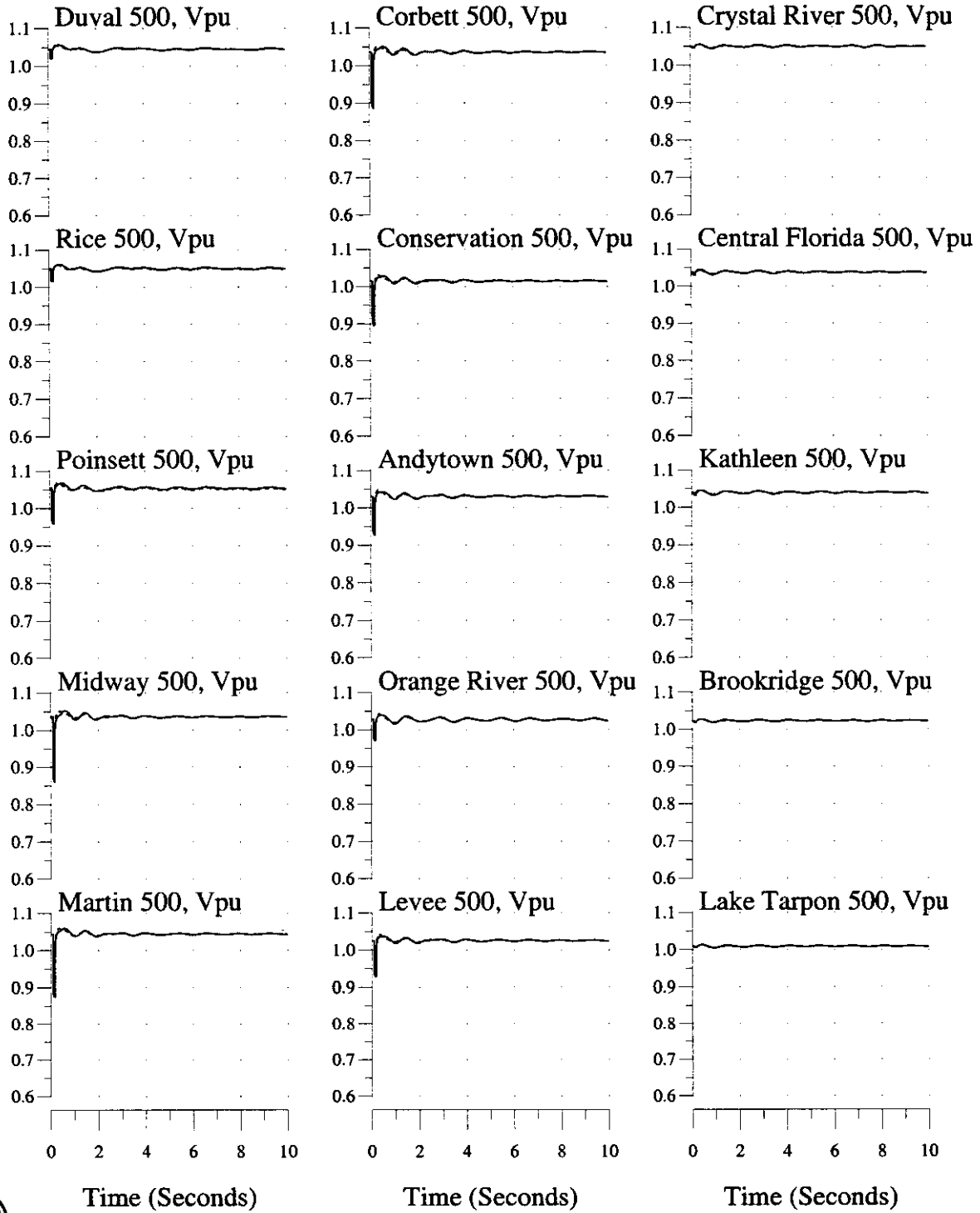

3-phase, 5-cycle Fault at Okeechobee 230kV Bus, Trip Okeechobee-Martin 230kV Line
2003 Summer System

Bus Variables: (___) With Okeechobee No. FPL Dispatch, (...) Without

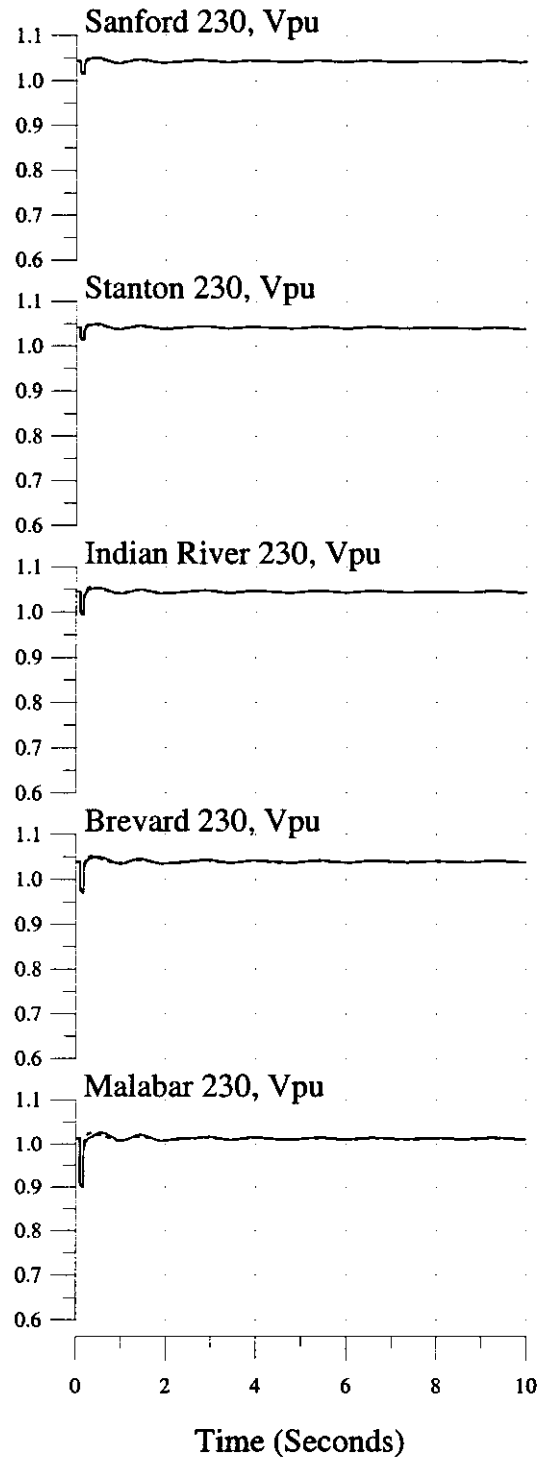
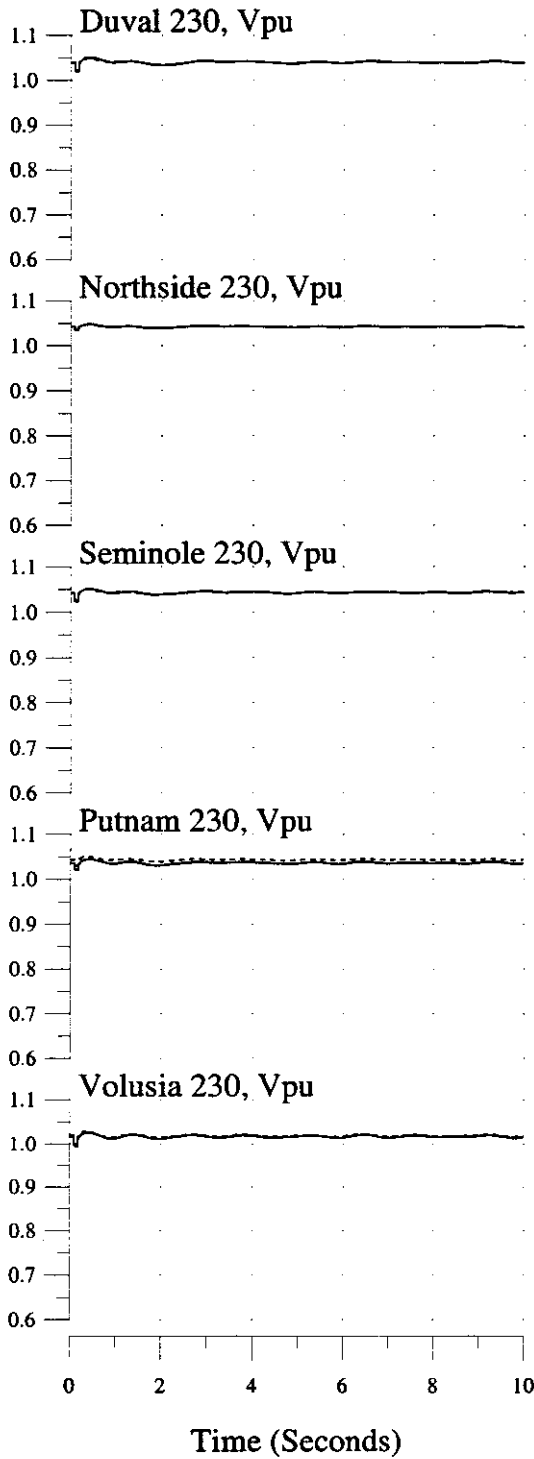

3-phase, 5-cycle Fault at Okeechobee 230kV Bus, Trip Okeechobee-Martin 230kV Line
2003 Summer System

Bus Variables: (—) With Okeechobee No. FPL Dispatch, (...) Without

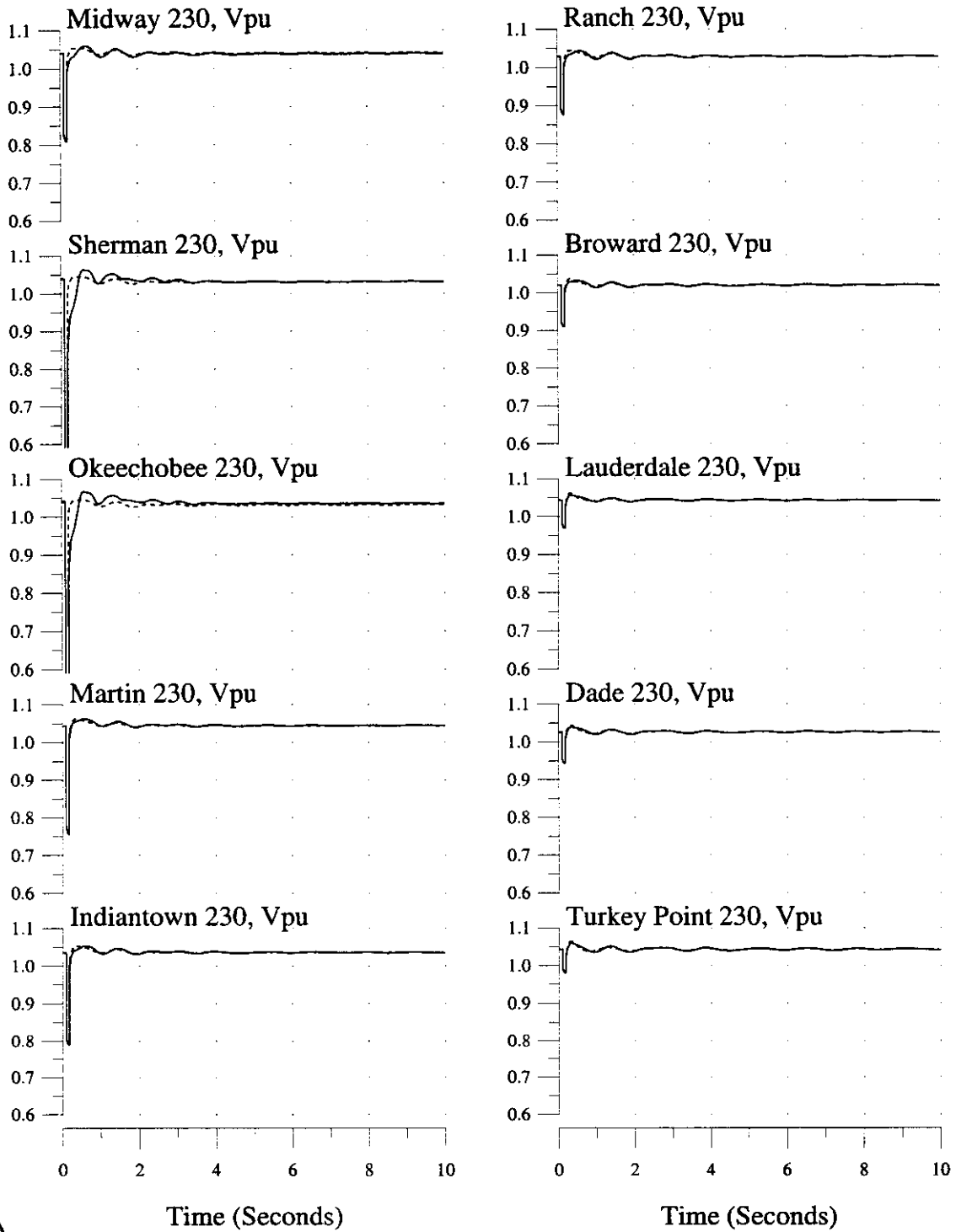

3-phase, 5-cycle Fault at Okeechobee 230kV Bus, Trip Okeechobee-Martin 230kV Line
2003 Summer System

Bus Variables: (___) With Okeechobee No. FPL Dispatch, (...) Without

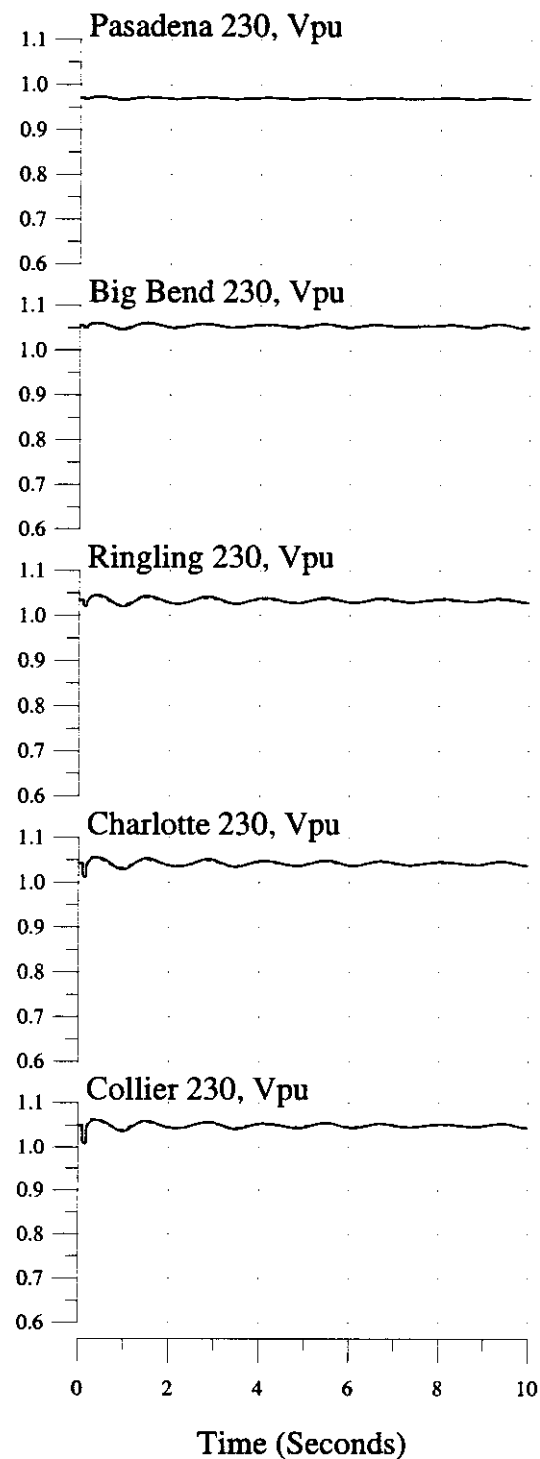
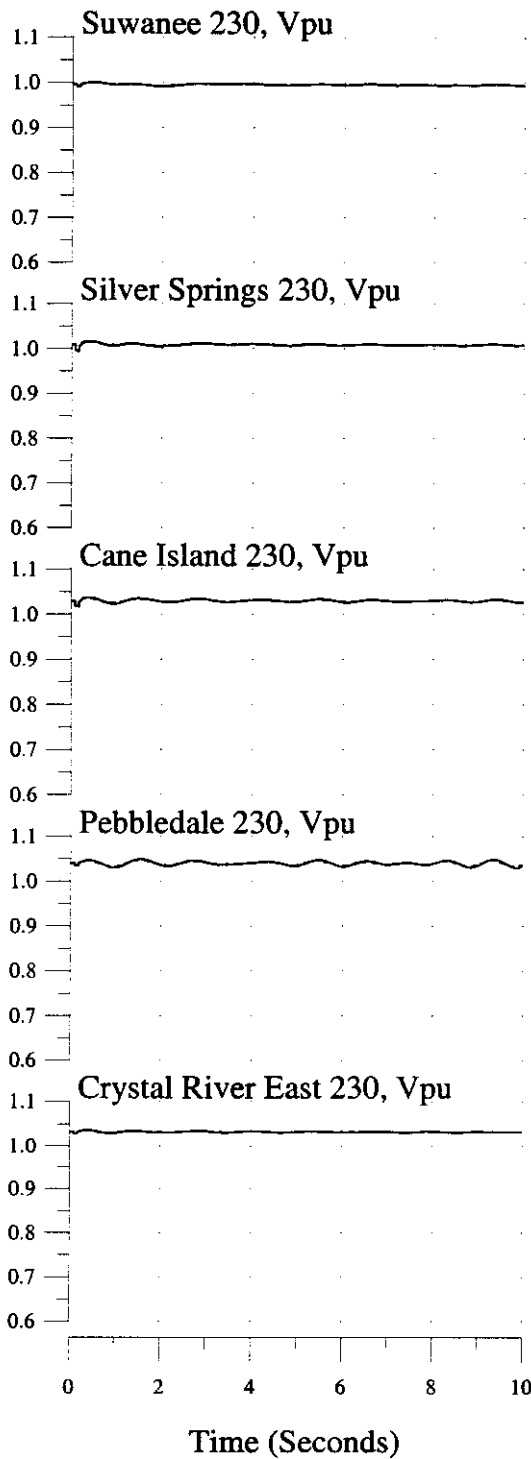

3-ph, 5-cy Fault at Martin 500kV Bus, Trip Martin #2 & GSU, TT Martin-Poinsett 500kV Line
 2003 Summer System

Machine & Interface Variables: (—) With Okeechobee No. FPL Dispatch, (...) Without

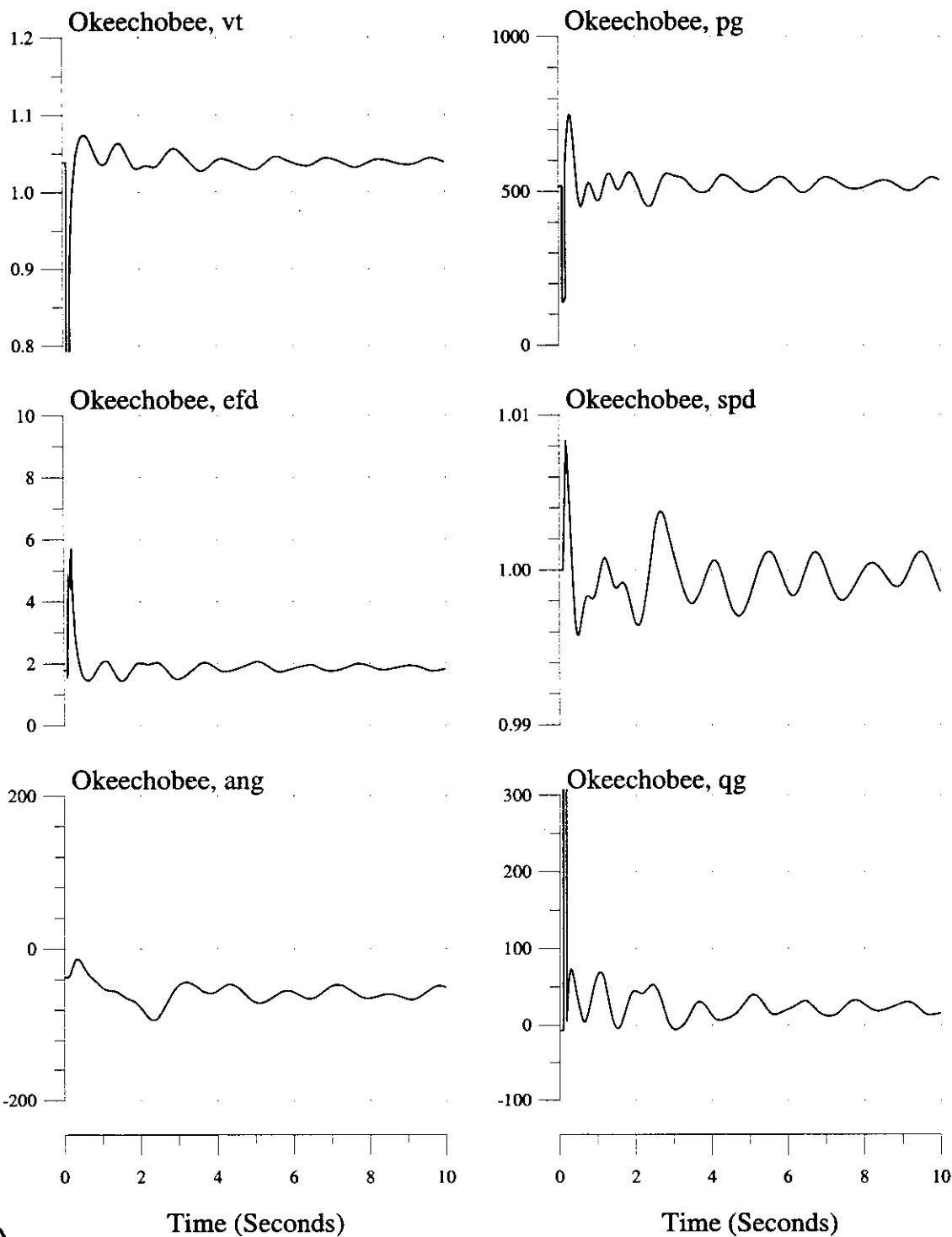

3-ph, 5-cy Fault at Martin 500kV Bus, Trip Martin #2 & GSU, TT Martin-Poinsett 500kV Line
2003 Summer System

Machine & Interface Variables: (—) With Okeechobee No. FPL Dispatch, (...) Without

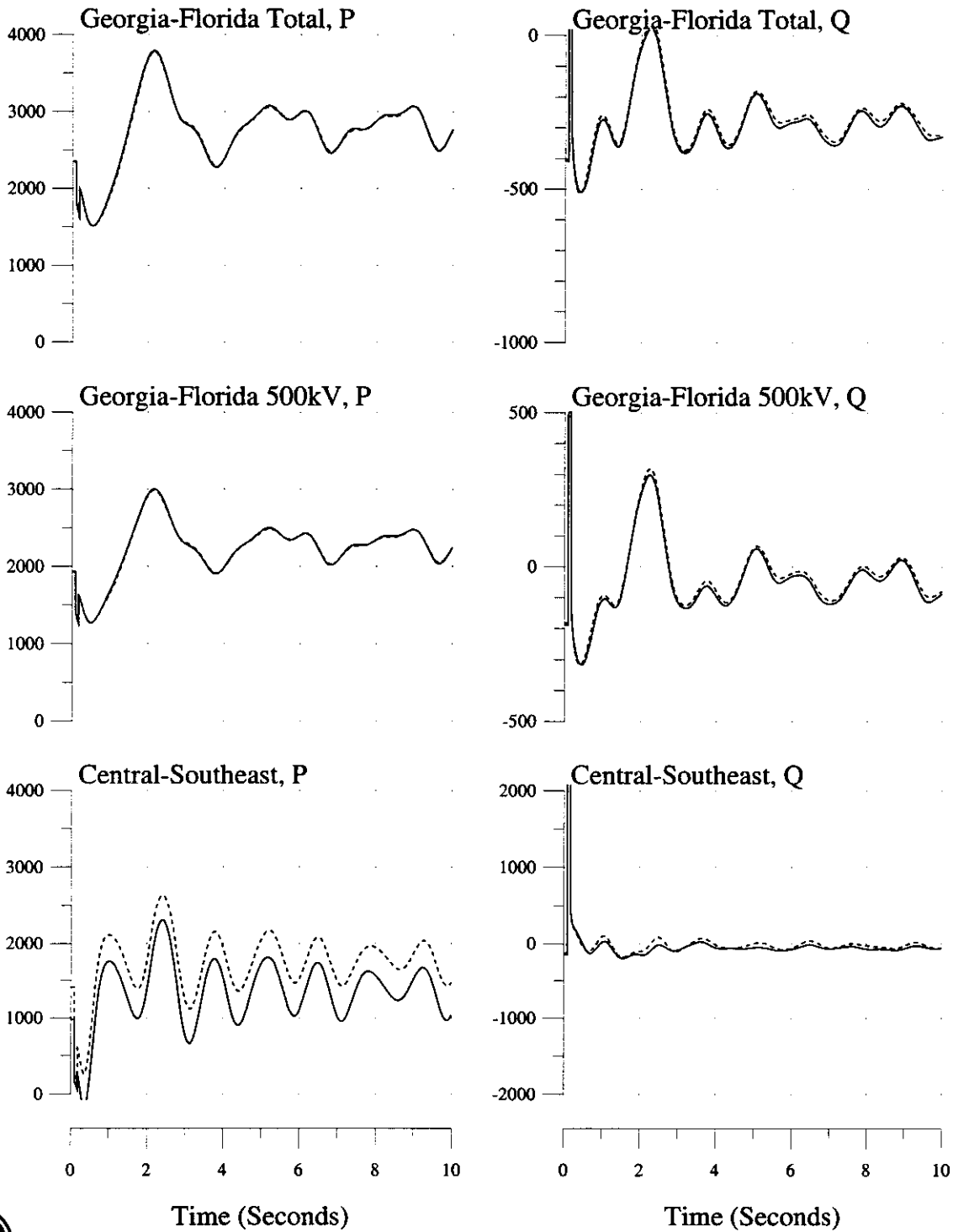

3-ph, 5-cy Fault at Martin 500kV Bus, Trip Martin #2 & GSU, TT Martin-Poinsett 500kV Line
2003 Summer System

Machine Variables: (—) With Okeechobee No. FPL Dispatch, (...) Without

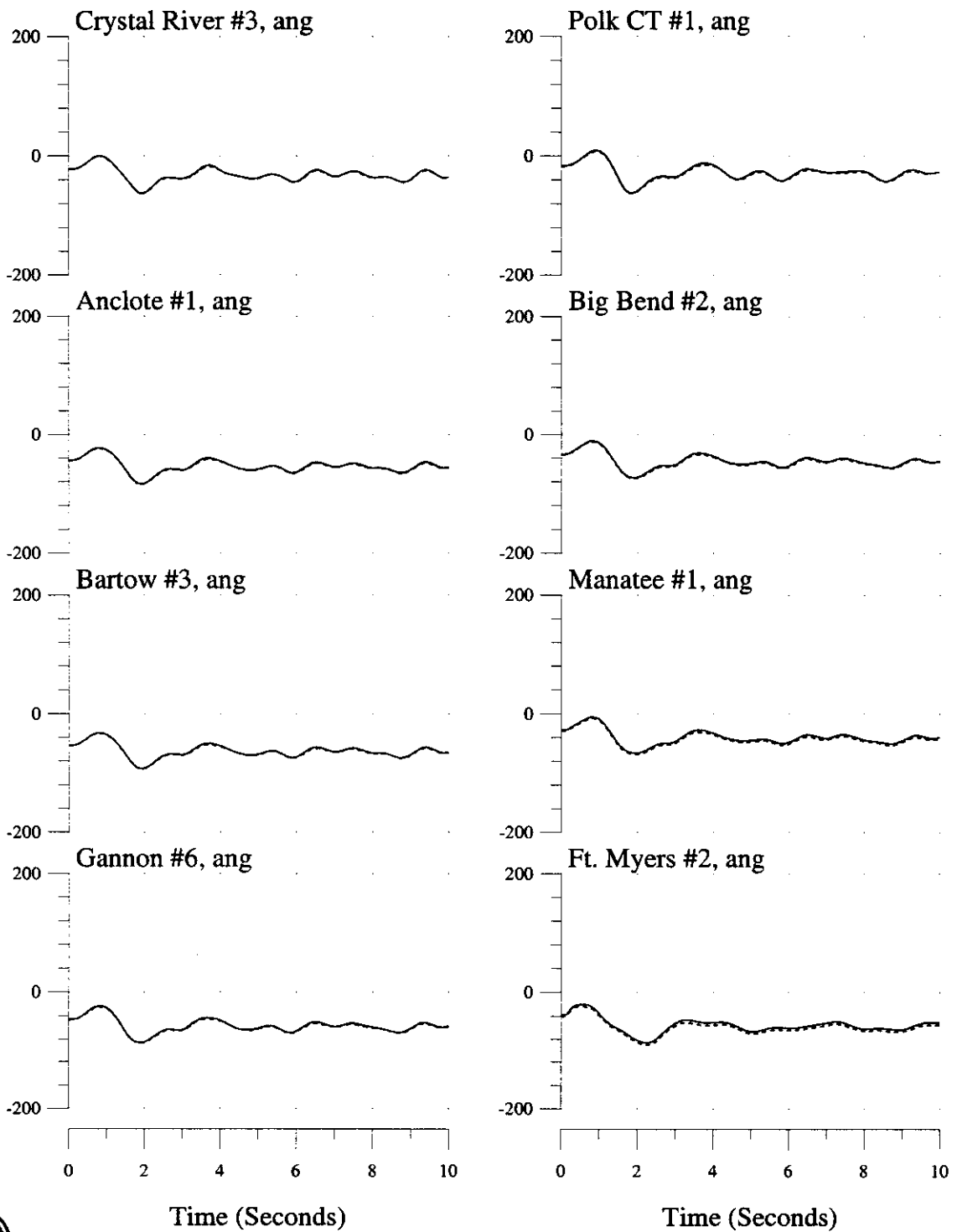

3-ph, 5-cy Fault at Martin 500kV Bus, Trip Martin #2 & GSU, TT Martin-Poinsett 500kV Line
2003 Summer System

Machine Variables: (___) With Okeechobee No. FPL Dispatch, (...) Without

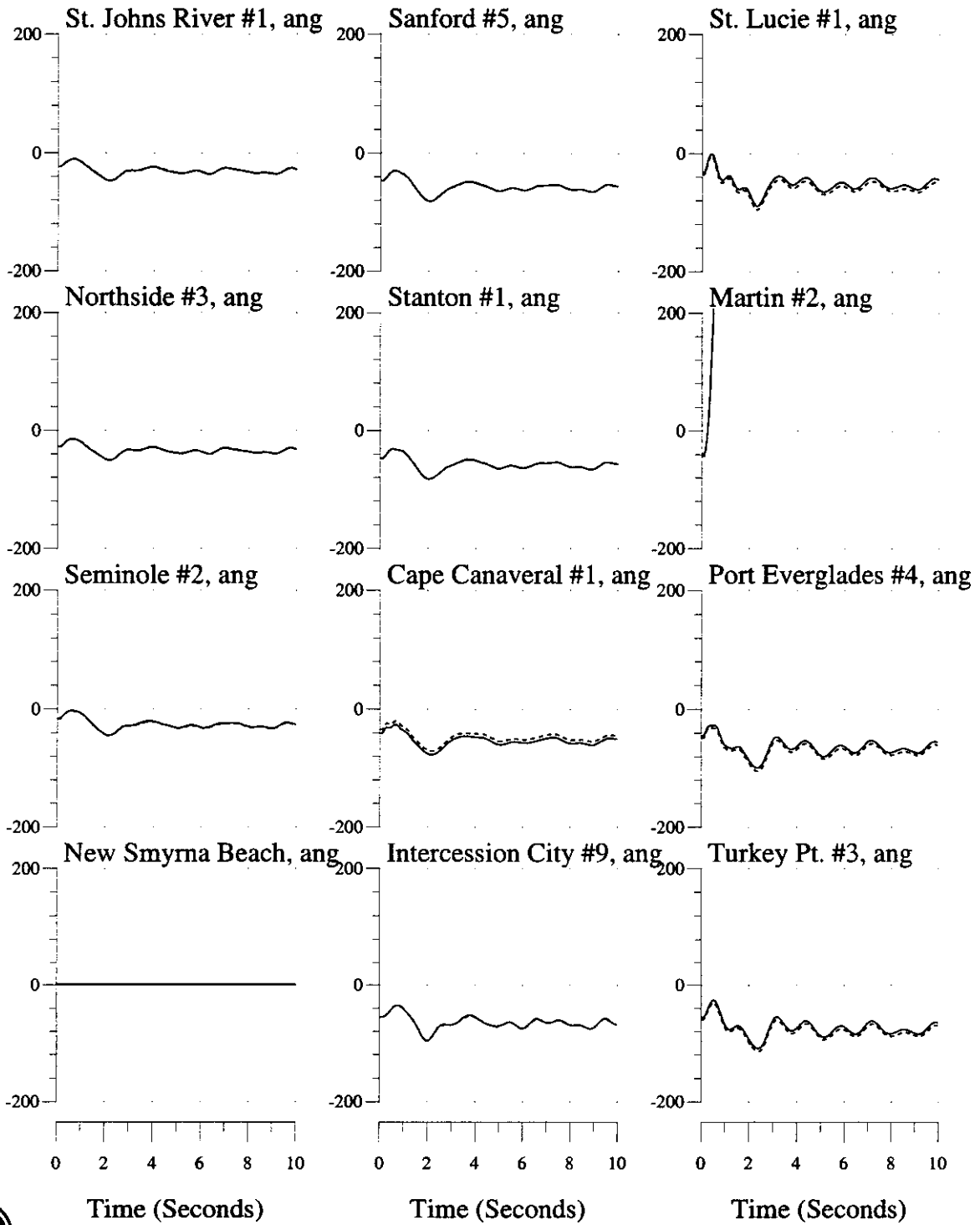

3-ph, 5-cy Fault at Martin 500kV Bus, Trip Martin #2 & GSU, TT Martin-Poinsett 500kV Line
 2003 Summer System

Bus Variables: (___) With Okeechobee No. FPL Dispatch, (...) Without

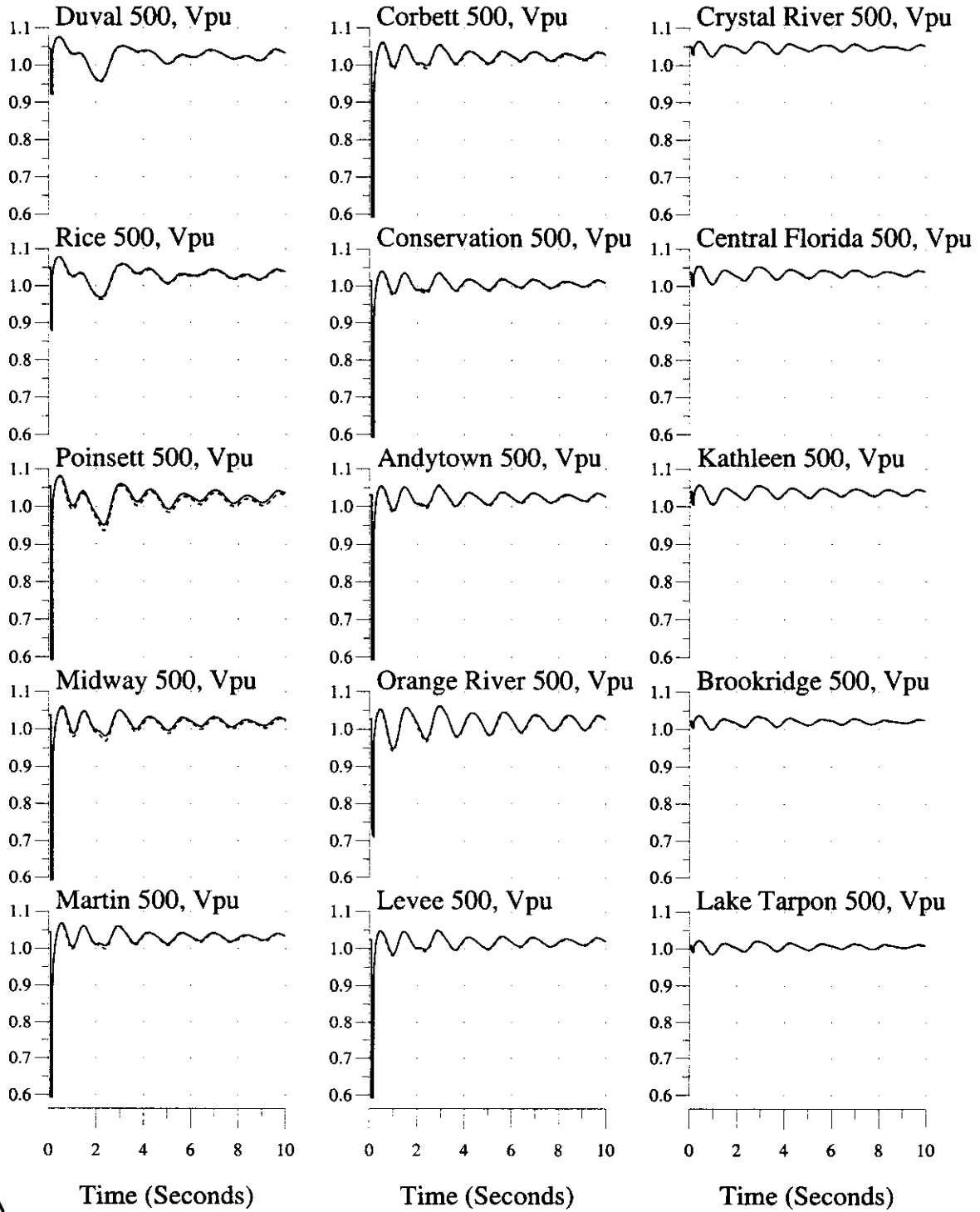

3-ph, 5-cy Fault at Martin 500kV Bus, Trip Martin #2 & GSU, TT Martin-Poinsett 500kV Line
 2003 Summer System

Bus Variables: (___) With Okeechobee No. FPL Dispatch, (...) Without

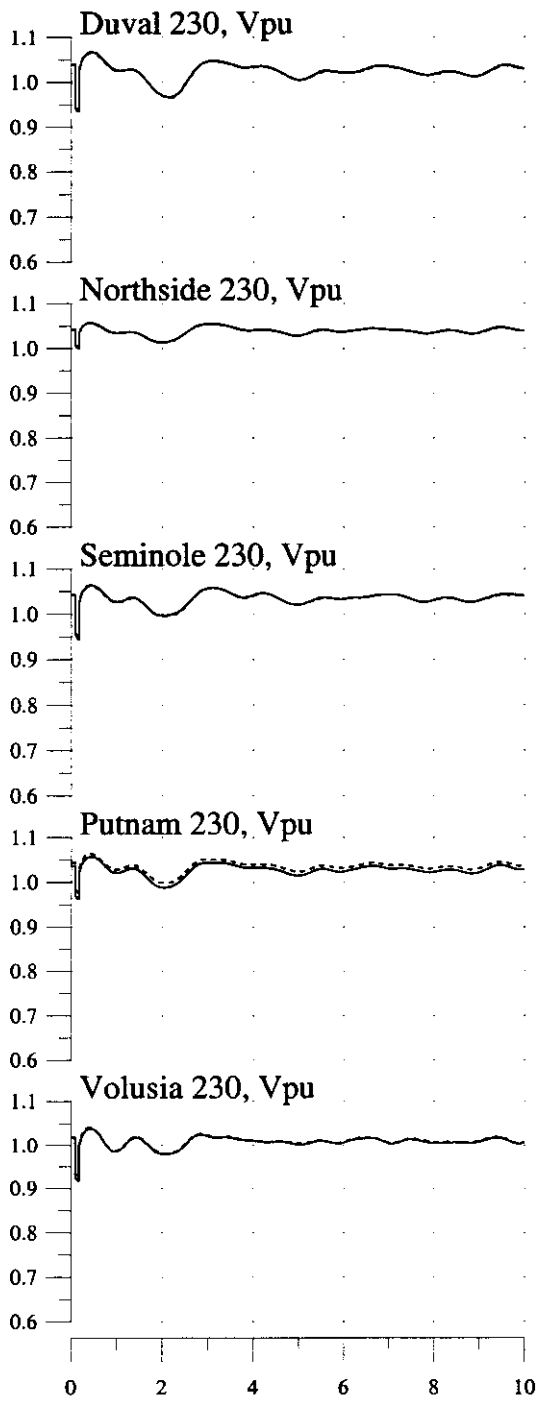

Time (Seconds)

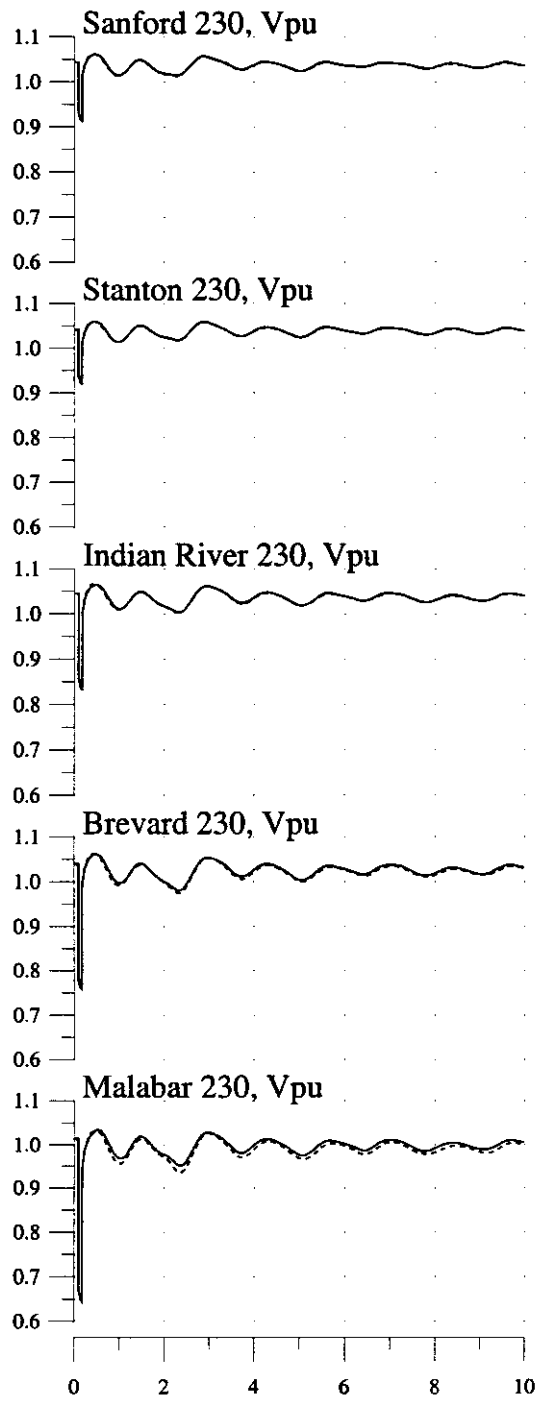

Time (Seconds)



3-ph, 5-cy Fault at Martin 500kV Bus, Trip Martin #2 & GSU, TT Martin-Poinsett 500kV Line
 2003 Summer System

Bus Variables: (—) With Okeechobee No. FPL Dispatch, (...) Without

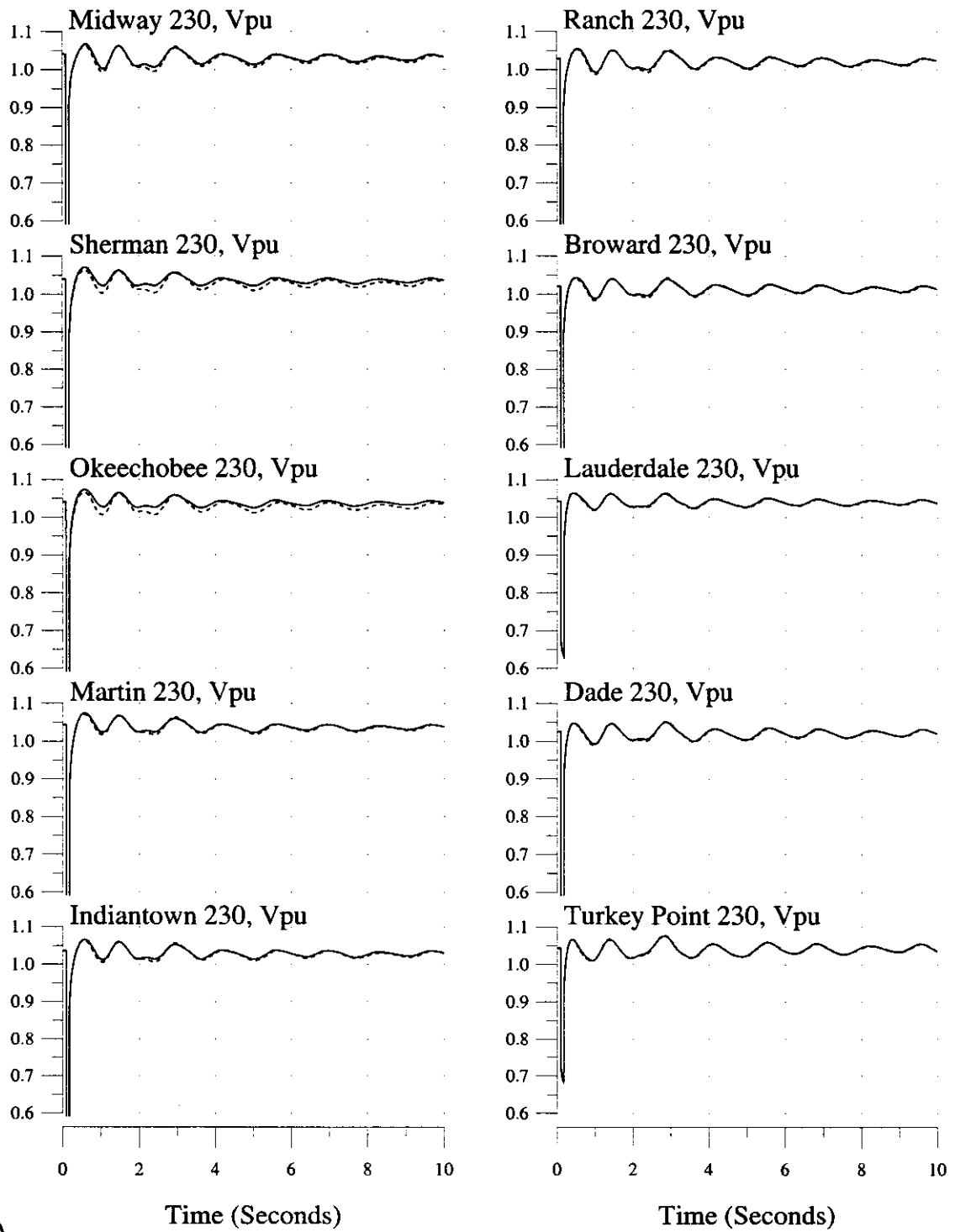

3-ph, 5-cy Fault at Martin 500kV Bus, Trip Martin #2 & GSU, TT Martin-Poinsett 500kV Line
2003 Summer System

Bus Variables: (___) With Okeechobee No. FPL Dispatch, (...) Without

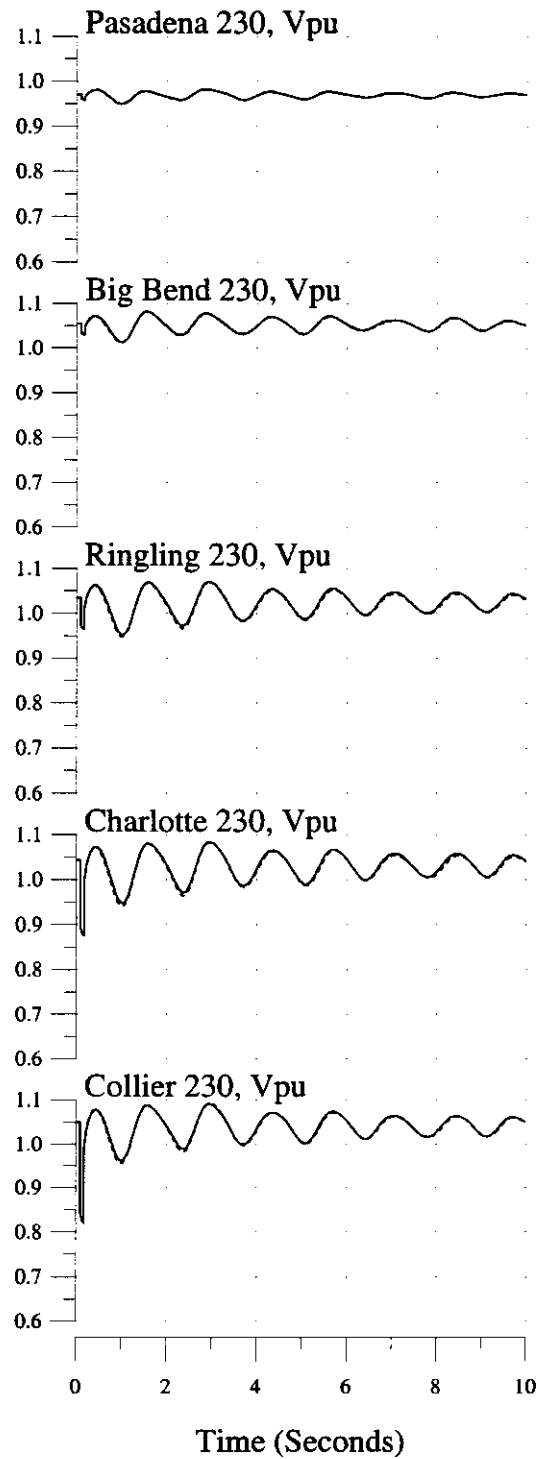
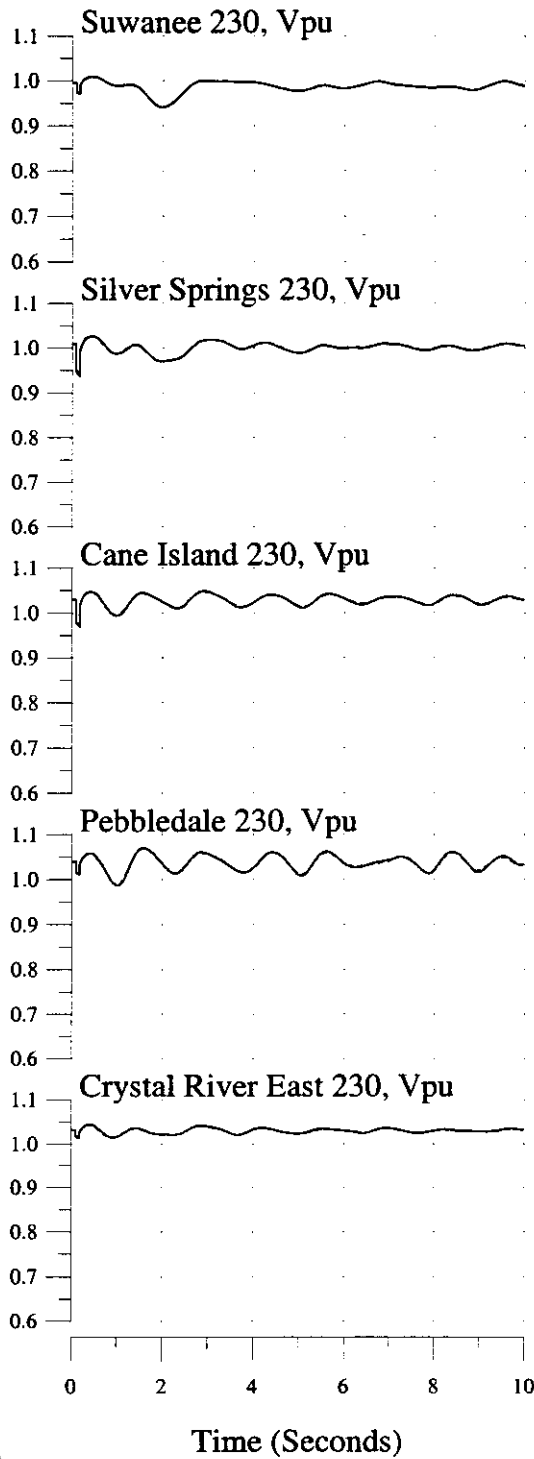

3-ph Fault at Turkey Pt 230kV Bus, Trip TP #3 & GSU @5-cy, Trip TP-Galloway 230kV Line @12cy
 2003 Summer System

Machine & Interface Variables: (___) With Okeechobee No. FPL Dispatch, (...) Without

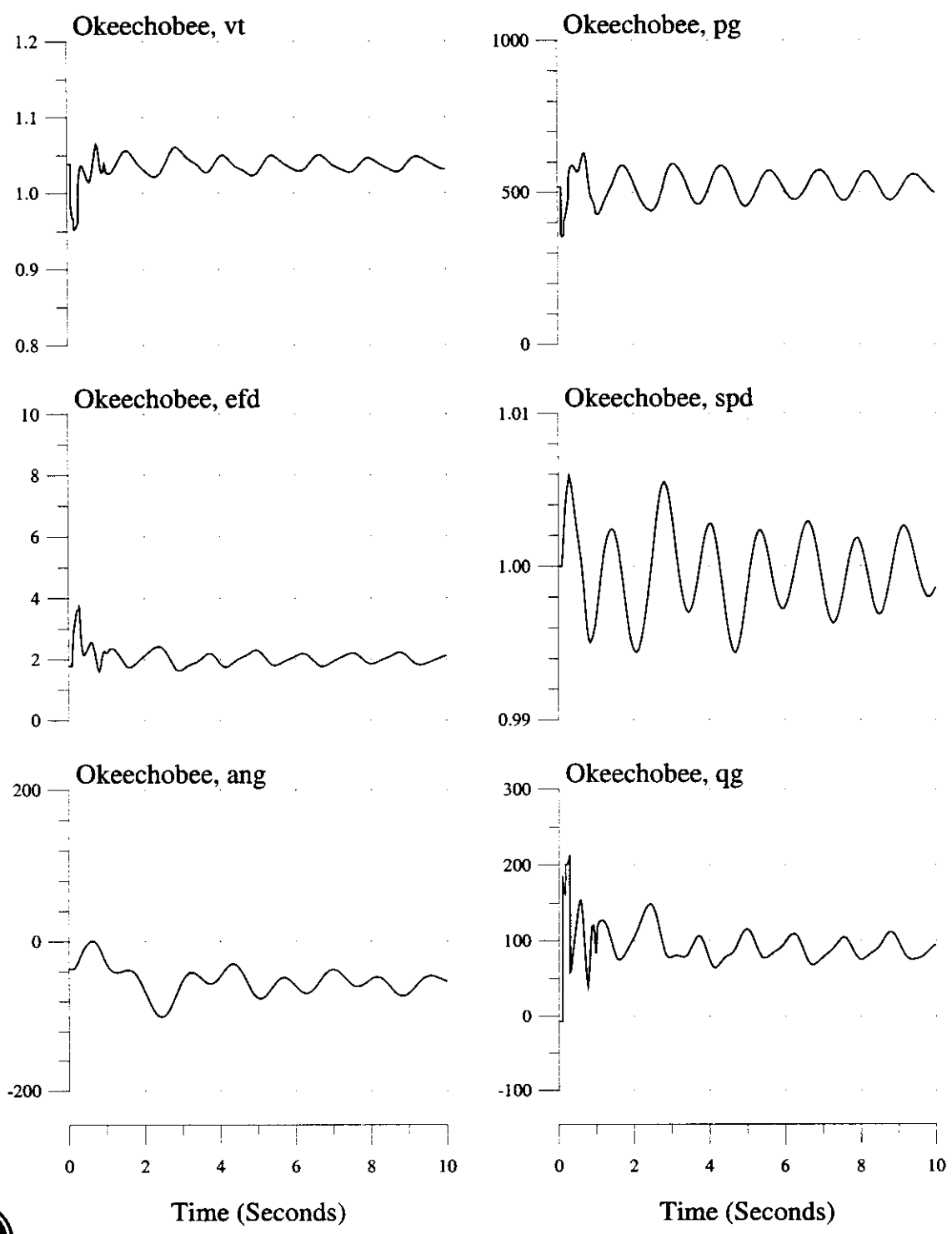

3-ph Fault at Turkey Pt 230kV Bus, Trip TP #3 & GSU @5-cy, Trip TP-Galloway 230kV Line @12cy
2003 Summer System

Machine & Interface Variables: (—) With Okeechobee No. FPL Dispatch, (...) Without

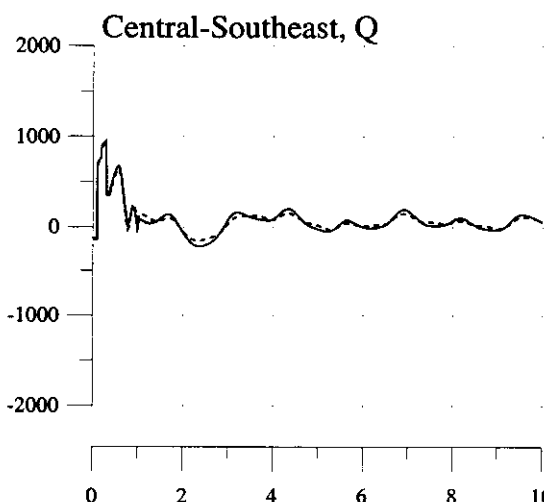
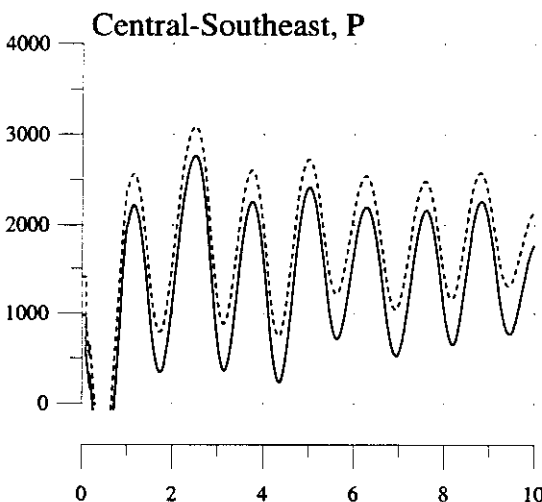
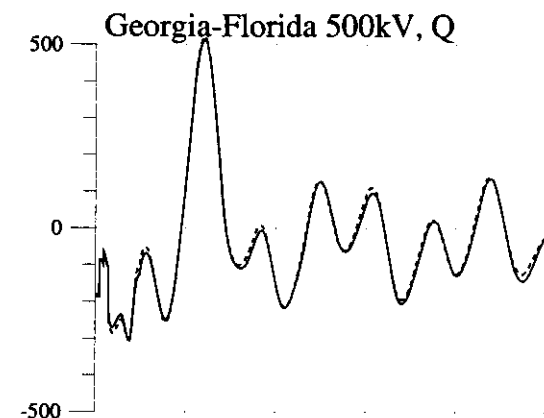
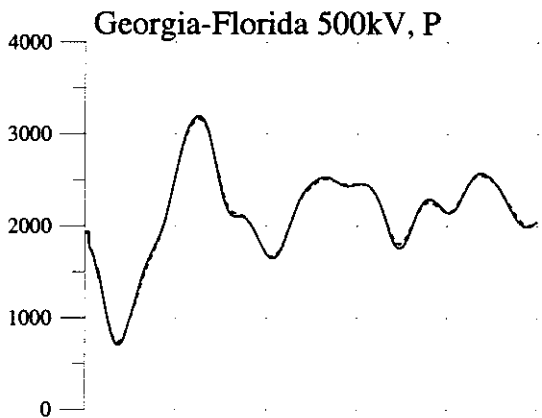
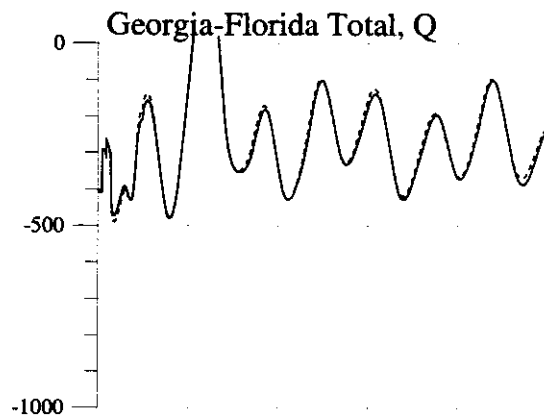
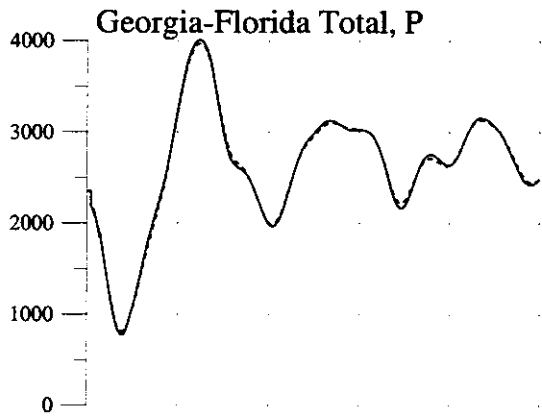

Time (Seconds)

Time (Seconds)



3-ph Fault at Turkey Pt 230kV Bus, Trip TP #3 & GSU @5-cy, Trip TP-Galloway 230kV Line @12cy
2003 Summer System

Machine Variables: (___) With Okeechobee No. FPL Dispatch, (...) Without

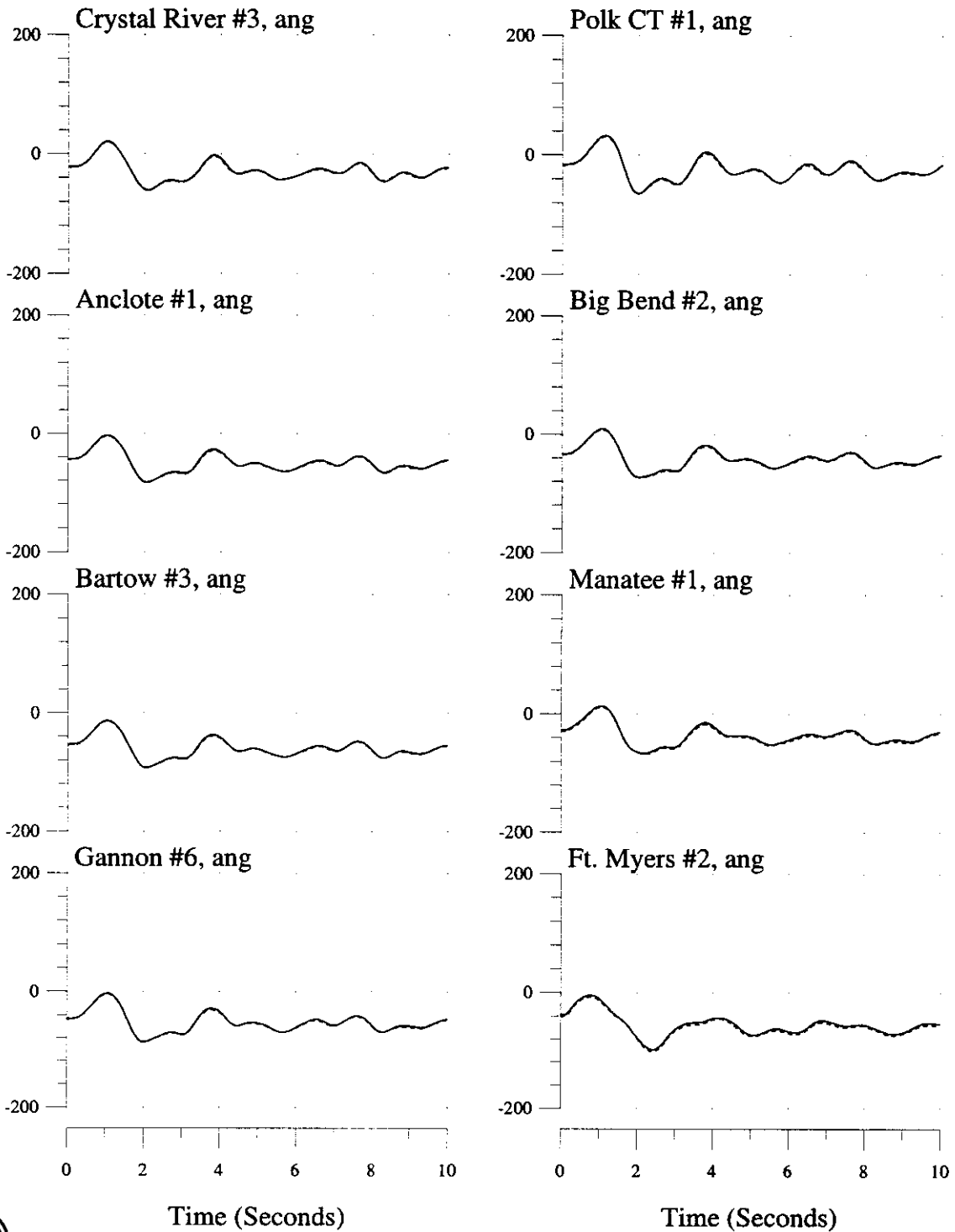

3-ph Fault at Turkey Pt 230kV Bus, Trip TP #3 & GSU @5-cy, Trip TP-Galloway 230kV Line @12cy
 2003 Summer System

Machine Variables: (___) With Okeechobee No. FPL Dispatch, (...) Without

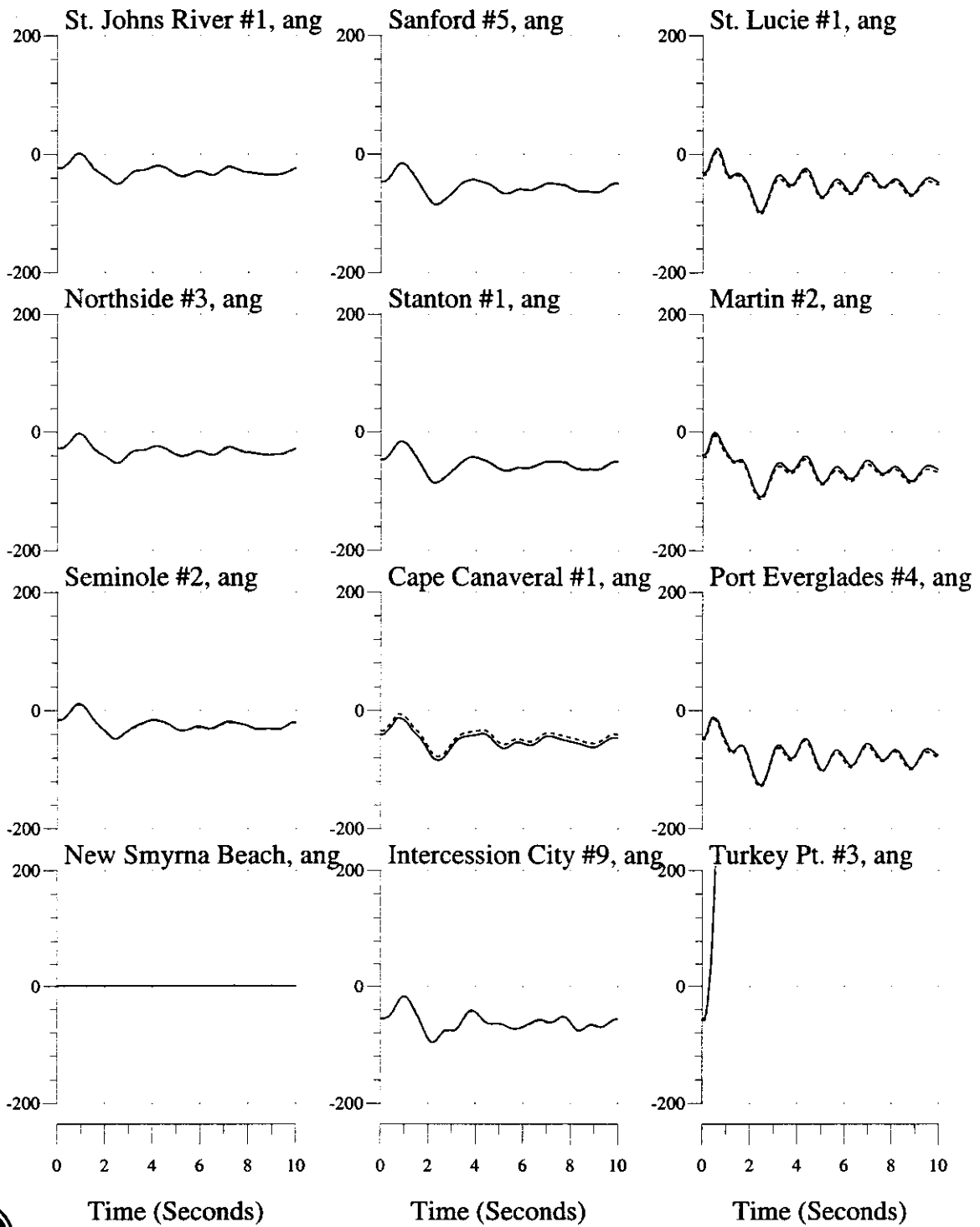

3-ph Fault at Turkey Pt 230kV Bus, Trip TP #3 & GSU @5-cy, Trip TP-Galloway 230kV Line @12cy
 2003 Summer System

Bus Variables: (___) With Okeechobee No. FPL Dispatch, (...) Without

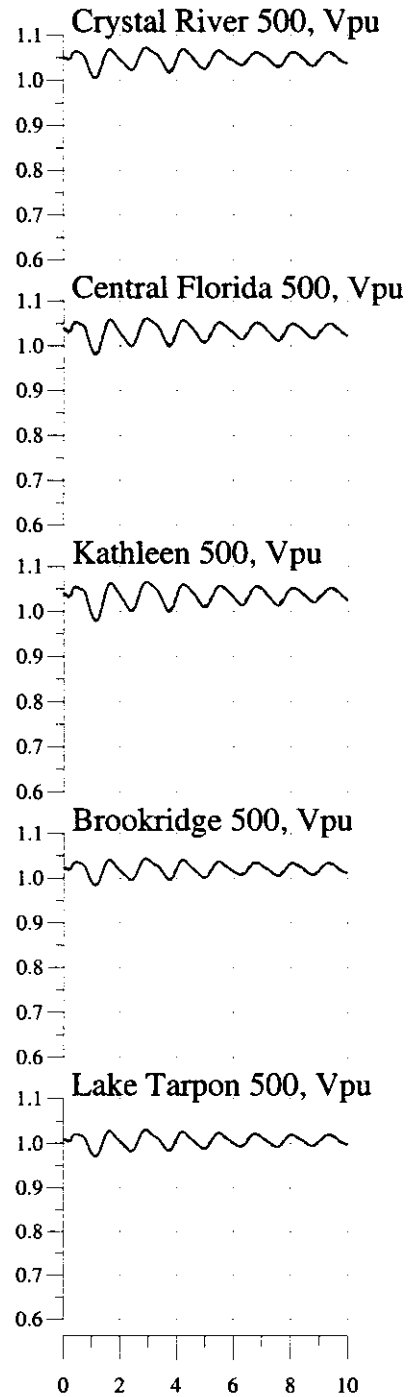
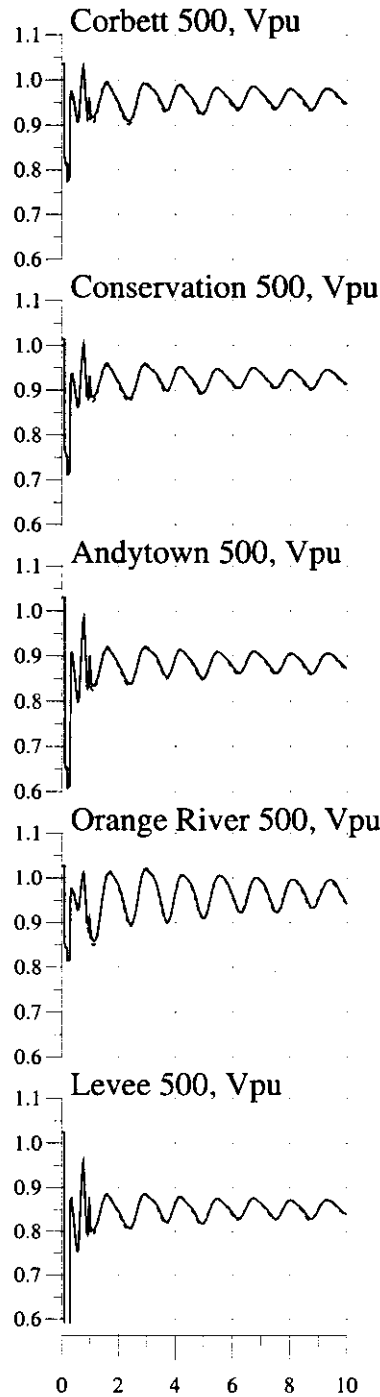
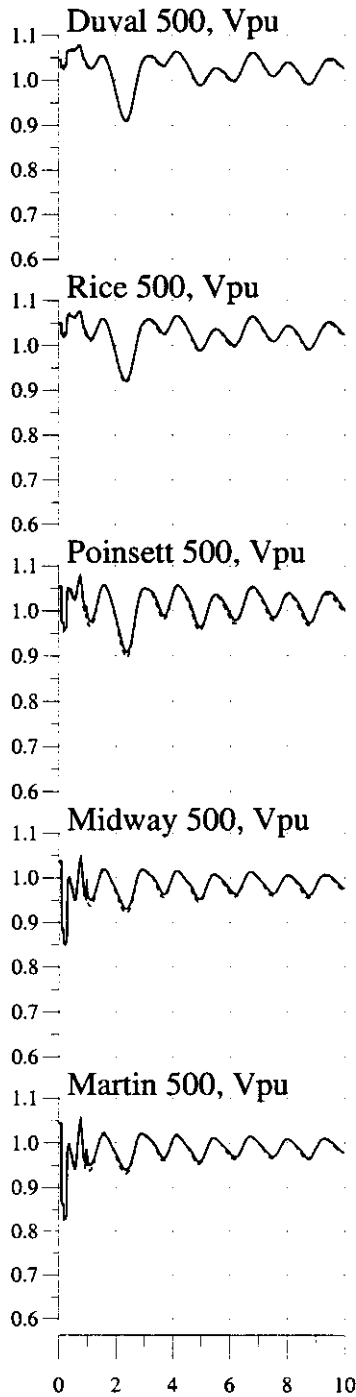

3-ph Fault at Turkey Pt 230kV Bus, Trip TP #3 & GSU @5-cy, Trip TP-Galloway 230kV Line @12cy
2003 Summer System

Bus Variables: (—) With Okeechobee No. FPL Dispatch, (...) Without

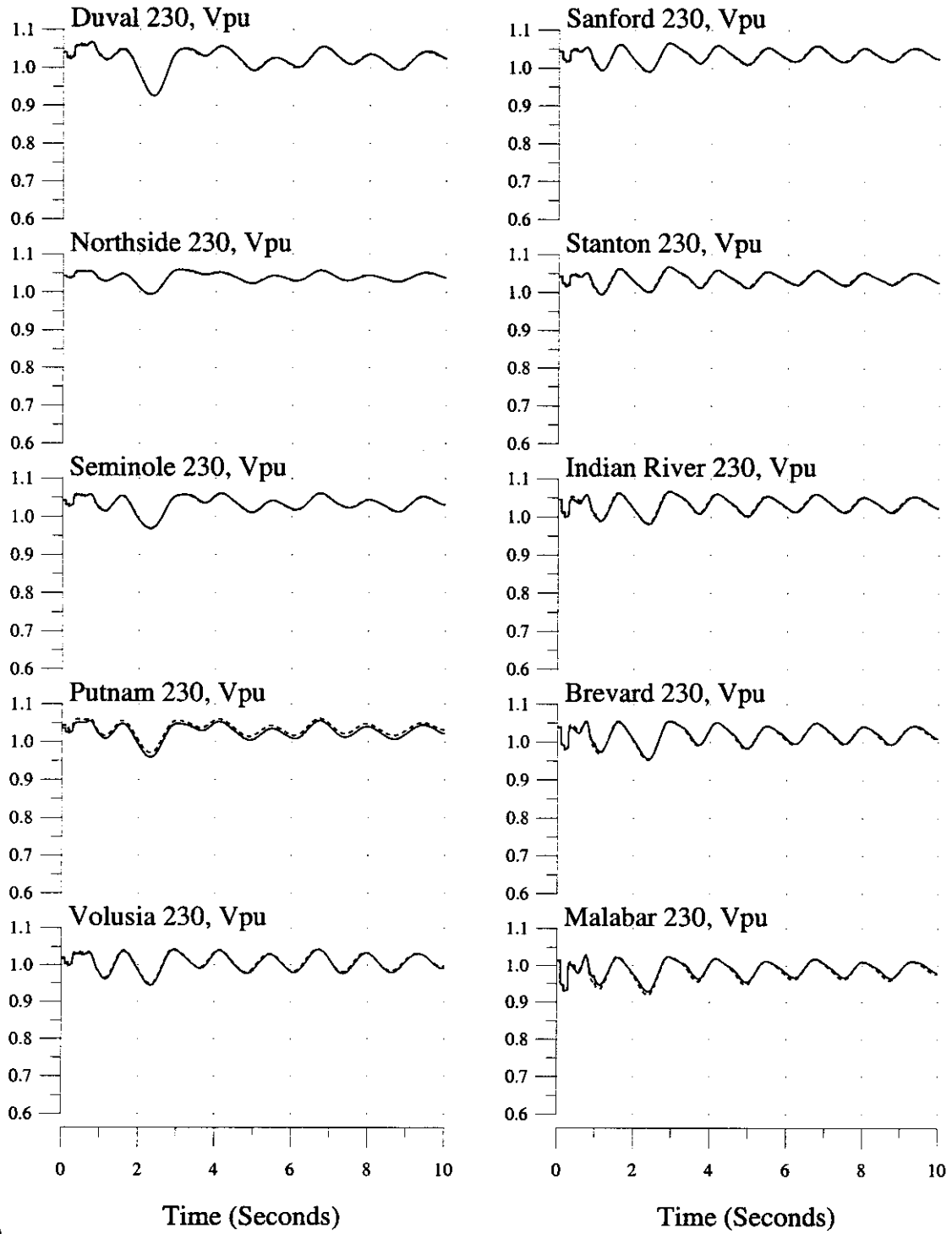

3-ph Fault at Turkey Pt 230kV Bus, Trip TP #3 & GSU @5-cy, Trip TP-Galloway 230kV Line @12cy
2003 Summer System

Bus Variables: (—) With Okeechobee No. FPL Dispatch, (...) Without

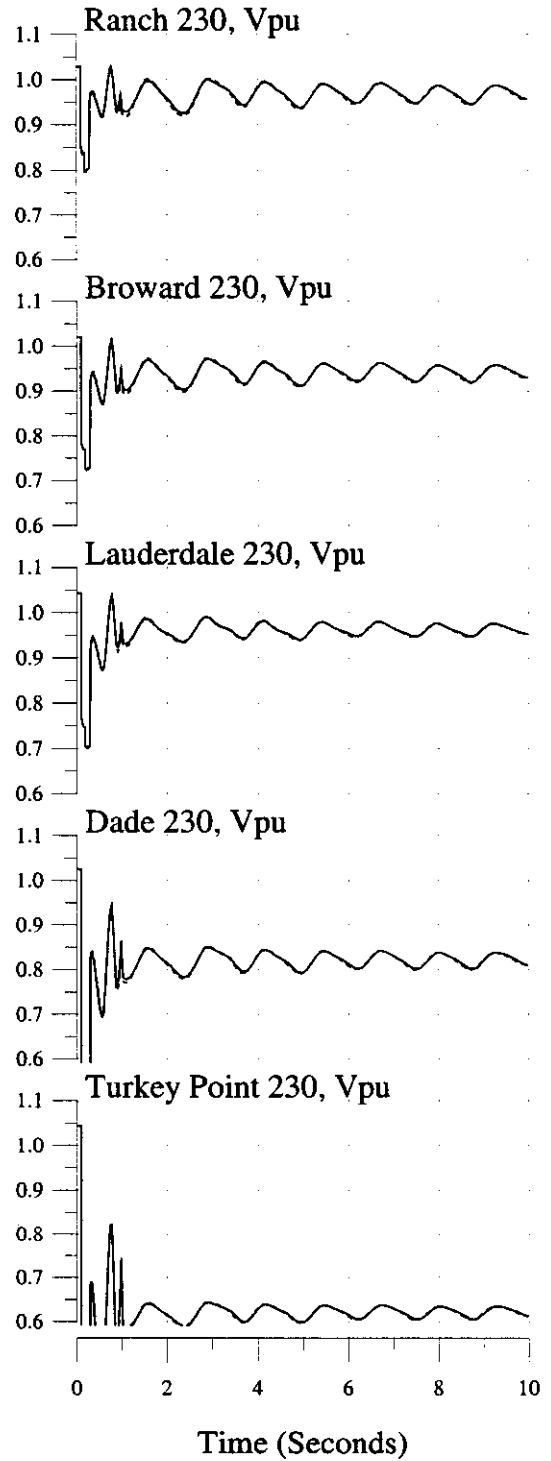
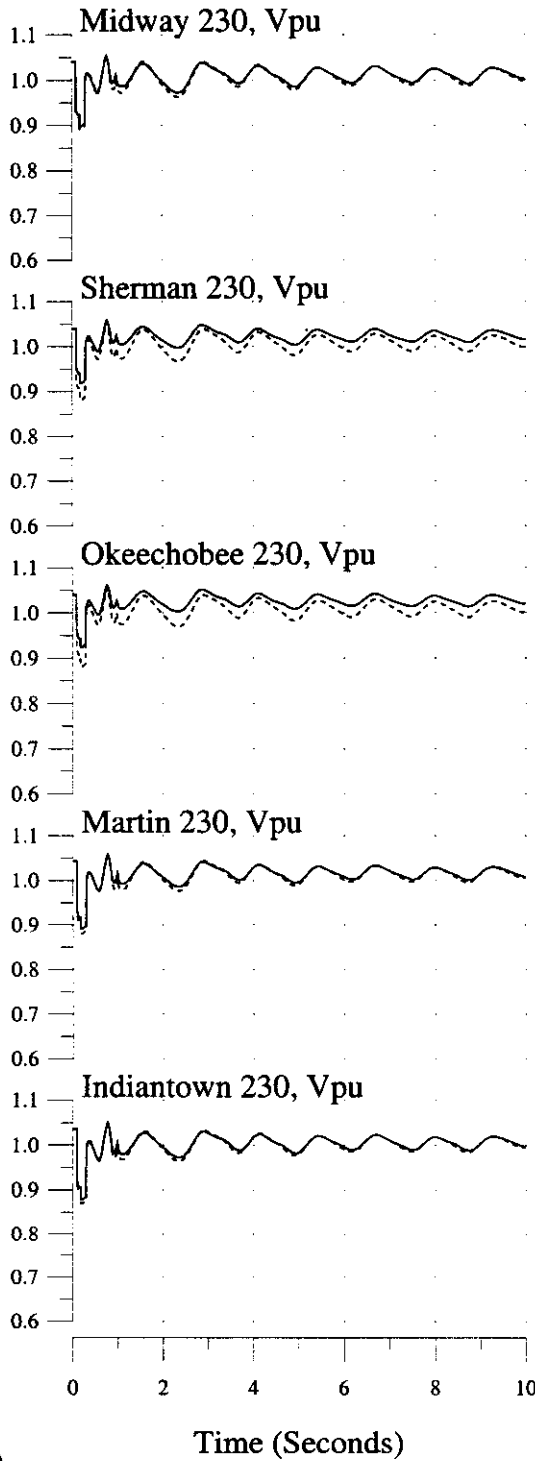

3-ph Fault at Turkey Pt 230kV Bus, Trip TP #3 & GSU @5-cy, Trip TP-Galloway 230kV Line @12cy
2003 Summer System

Bus Variables: (___) With Okeechobee No. FPL Dispatch, (...) Without

