

Docket No. 2020001-EI  
Cross-Examination  
Hearing Exhibit

Exhibit No.: 9

Proffered by: Public Counsel

Short title: Management Review Board - St. Lucie Ground Fault

Witness(s): FPL- Coffey



**MANAGEMENT REVIEW BOARD  
ATTACHMENT 1 – COMPLETED ITEM REVIEW  
ST. LUCIE NUCLEAR STATION  
JUNE 4, 2019**

**ATTENDANCE ROSTER:**

Quorum	SD**	OPS	ENG	MNT	PI	SEC	LIC
Primary	D. DeBoer	B. Beltz	M. Jones	D. Sluszka	W. Godes	Q. Hernandez	M. Snyder
Alternate	M. Jones	T. Spillman (S)	B. Ross	G. Thomas	G. Atkinson	J. Berlett	K. Frehafer
	B. Beltz	A. Terezakis (S)	P. Rasmus (S)	R. Costello (S)	D. Eykelhoff	D. Lane	R. Sciscente
	M. Snyder	W. Zuppe	A. Dong (S)	P. Ensmenger	T. Schoemer	E. Gonzalez	M. Dimarco
	D. Sluszka	T. Miller (S)			T. Ouret		P. Polfeit
		T. Plower (S)			E. Feightner		K. Paez
		J. Folden (S)* (7-8-19)			R. Virgin		
		W. Rexrode (S)* (8-11-19)					

\*JFG or LMS Item Pending Completion of Qualification; \*\*Anyone with SD signature meets the quorum of PGM.

- Has everyone reviewed the package?
- Are all items ready to be presented, with a representative?
- Meeting Pluses / Deltas
- One quorum member will be a current or previous SRO, or possess a SRO certification (S). ✓
- RCEs have the appropriate MRC tracking assignments created in NAMS for EFRs.
- Review Operability and Functionality assignment extensions from the previous month for compliance.

**10CFR50 Appendix B SECTION XVI Corrective Action**

Measures shall be established to assure that conditions adverse to quality, such as failures, malfunctions, deficiencies, deviations, defective material and equipment, and nonconformances are promptly identified and corrected. In the case of significant conditions adverse to quality, the measures shall assure that the cause of the condition is determined and corrective action taken to preclude repetition. The identification of the significant condition adverse to quality, the cause of the condition, and the corrective action taken shall be documented and reported to appropriate levels of management.

Note: MRC will review all completed Adverse Trends and Potential Adverse Trend Investigations.

**Agenda:**

AGENDA ITEM (NOTE: Manager of Department listed is responsible for representing agenda item)	DEPT	SPONSOR
1. RCE 2312208-01 "Unit 1 Main Generator Ground Fault Interim Root Cause Evaluation Report"	Engineering	M. Jones
2.		
3.		

1524

# St. Lucie Station

## *Unit 1 Main Generator Ground Fault Interim Root Cause Evaluation Report*

**Event Date: 04/25/2019**

**CR Number: 02312208**

Root Cause Team	Name	Dept/Group
Management Sponsor	Mark Jones	Engineering Director
Team Leader	Anas Bouchfaa	Engineering
RC Evaluator	Gary Arntson	Engineering
Team Members	Don Zoll	Maintenance
	Andy Terezakis	Operations

Root Cause Evaluator: GARY ARNTSON / Gary Arntson Date: 5/31/19  
Print/Sign

Management Sponsor: MARK JONES / Mark Jones Date: 5/31/19  
Print/Sign

MRC Chair: \_\_\_\_\_ Date: \_\_\_\_\_  
Print/Sign

*Electronic Signature may be obtained by assigning actions in NAMS.  
Refer to PI-AA-104-1000 for details.*

The root cause process is designed to be self critical to drive improvement. As such, specific organizational and/or programmatic causes within the plant's span of control are identified. The root cause process determines a functional cause and not a legal or contractual cause.



## Unit 1 Main Generator Ground Fault RCE

AR 02312208

**1.0 Executive Summary**

On 04/25/2019 St Lucie Unit 1 tripped due to a generator lockout during performance of a Reactive Power Lagging Capability Test. The lockout was initiated due to a ground fault in the generator. The fault condition was verified using electrical testing and determined to be in the C phase winding of the stator, however the location could not be identified during less-intrusive inspections. After generator disassembly and rotor removal, the fault was located to a specific half-coil stator bar in the bottom of slot 17 (B17) in the stator core. The fault was determined to be unrepairable in place. A decision was made to perform a generator rewind to address the faulted coil.

The ground fault location was ultimately identified and attributed to a localized breach in the ground wall insulation of stator bar B17. This interim root cause evaluation report documents initial findings and various possible causal factors based on available field data. The failure process that led to the fault was not apparent from the initial investigations. The failed stator bar and a sampling of other non-failed stator bars were held for lab testing to determine the failure process; therefore, the root cause is indeterminate pending further analysis.

An extent of condition review of Unit 2 generator maintenance history has been completed. The Unit 2 generator completed high potential testing in September 2018 and the insulation successfully withstood the high potential test voltage. It can be concluded that a similar ground fault was not present and is not likely in the near term.

**Interim Causal Factor determination**

Ground wall insulation failure of Stator Bar B17 in the Phase C Stator Winding

**Interim Corrective Action**

Complete rewind of the Unit 1 generator to restore stator winding to serviceable condition.

## Unit 1 Main Generator Ground Fault RCE

AR 02312208

**2.0** Report**1.** Event Description

On 04/25/2019 St Lucie Unit 1 Operators commenced performance of a Reactive Power Lagging Capability Test in accordance with procedure 0-OSP-53.01. Pre-requisite and risk mitigation activities for the test were completed including verification of generator H2 gas pressures, pre-test predictive maintenance checks and cooling water system performance reviews, securing all load threat work activities both in the plant and switchyard, staging personnel for monitoring exciter fuses and generator vibrations during the test, and establishing pre-planned operating conditions in accordance with St Lucie Unit 2 and Transmission System Operations (TSO).

At 0819 Unit 1 began reactive power ascension. At 0835 the Unit 1 generator reached the test reactive power of 255MVAR out and began 1 hour hold as specified in the test procedure. Operators began manual logging of test data on 15 minute intervals. At 0935 the generator backup lockout was tripped. Automatic turbine and reactor trip occurred in response to the lockout as expected.

Initial investigations determined that the lockout was initiated by operation of backup ground protection relay 64GB/881. The relay's protection zone includes the Main Generator, Isolated Phase bus and associated potential transformers, the high voltage side of Main Transformers 1A and 1B, and the high voltage side of Aux Transformers 1A and 1B. A failure investigation team was chartered in accordance with EN-AA-108-1001 to investigate the ground fault. Digital Fault Recorder data captured for the event provided evidence that a valid ground fault condition was present and likely located on the C phase. After removal of generator flexible links to separate the machine from the isolated phase bus, and to separate each phase at the neutral bus, a ground was confirmed internal to the generator on phase C. Subsequent disassembly and testing confirmed the bottom stator bar in slot 17 of the generator (B17) had a low resistance ground.

**2.** Problem Statement

The Unit 1 Main Generator experienced a ground fault during performance of a reactive power lagging capability test. The ground fault resulted in a generator lockout and reactor trip.



### 3. Analysis

#### A. Background Information on Unit 1 Generator

The St Lucie Unit 1 Main Generator is an 1800rpm direct hydrogen inner-cooled synchronous unit originally supplied by the Westinghouse Electric Company with a rating 1000MVA. During the SL1-24 outage various modifications were performed by Siemens Energy, the current OEM, to achieve increased output for the Extended Power Uprate project. These modifications included rotor replacement and stator rewind to increase the rating from 1000MVA to 1200MVA [D19,D21,D22].

The 'stator' is the primary stationary component of the generator consisting of a stator core, three phase windings, and the generator leads which conduct the electrical power from the stator windings. Several images of the Unit 1 generator during rewind in SL1-24 are presented on the following pages to illustrate the stator construction. The core is constructed using laminations of steel with slots to receive the stator coils (Figure 1). The windings each consist of a series of distributed single turn coils. The coils are constructed using half coil 'stator bars' installed within slots in the core (Figure 2 and 3) and connected at the ends of the stator outside of the core Figure 4).

Each stator bar contains conductor, hydrogen cooling tubes, and several layers of materials forming the insulation system (Figure 5 and 6). The conductor consists of copper strands that are individually insulated from each other to reduce losses and arranged close to the cooling tubes for heat removal. The ground wall insulation is 'Thermalastic'; a trademarked insulation system originally developed by Westinghouse consisting of layers of inorganic mica tape impregnated with an organic epoxy resin.

Special semi-conductive layers are applied to protect the ground wall insulation from partial discharges (sometimes termed corona) which are damaging to the organic components of the insulation. The Inside Corona Protection (ICP) is applied around the conductor strands under the ground wall. The ICP layer incorporates a conductive copper strip connected to a strand at one end of the stator bar to provide a drain for excess electrical charge. The Outside Corona Protection (OCP) layer is applied over the ground wall insulation. The OCP is maintained in contact with the grounded core laminations to provide a drain path for excess electrical charge outside the ground wall.

Figure 1 – Stator Core prior to Coil Installation

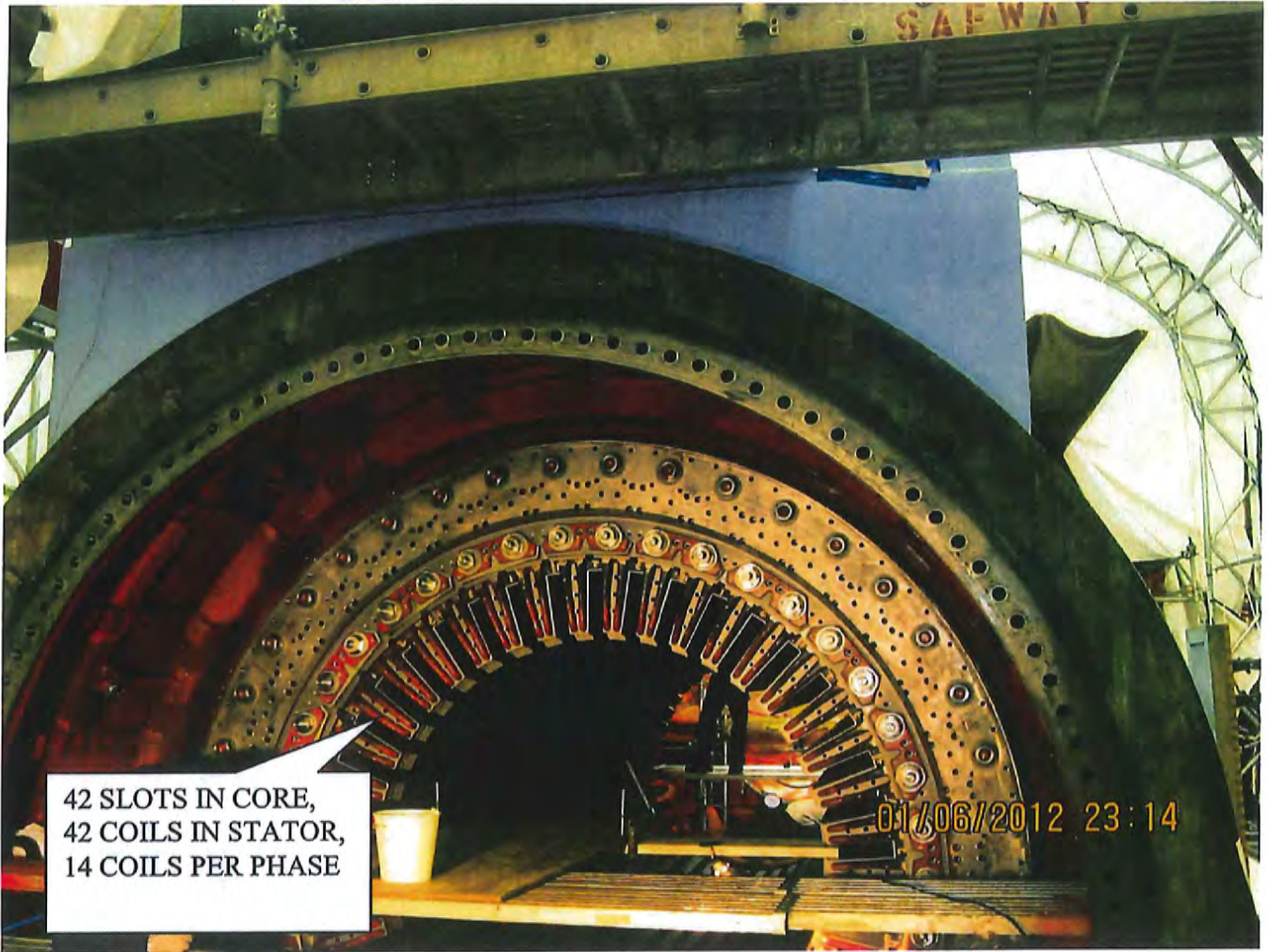



Figure 2 – Bottom Half-Coil installation

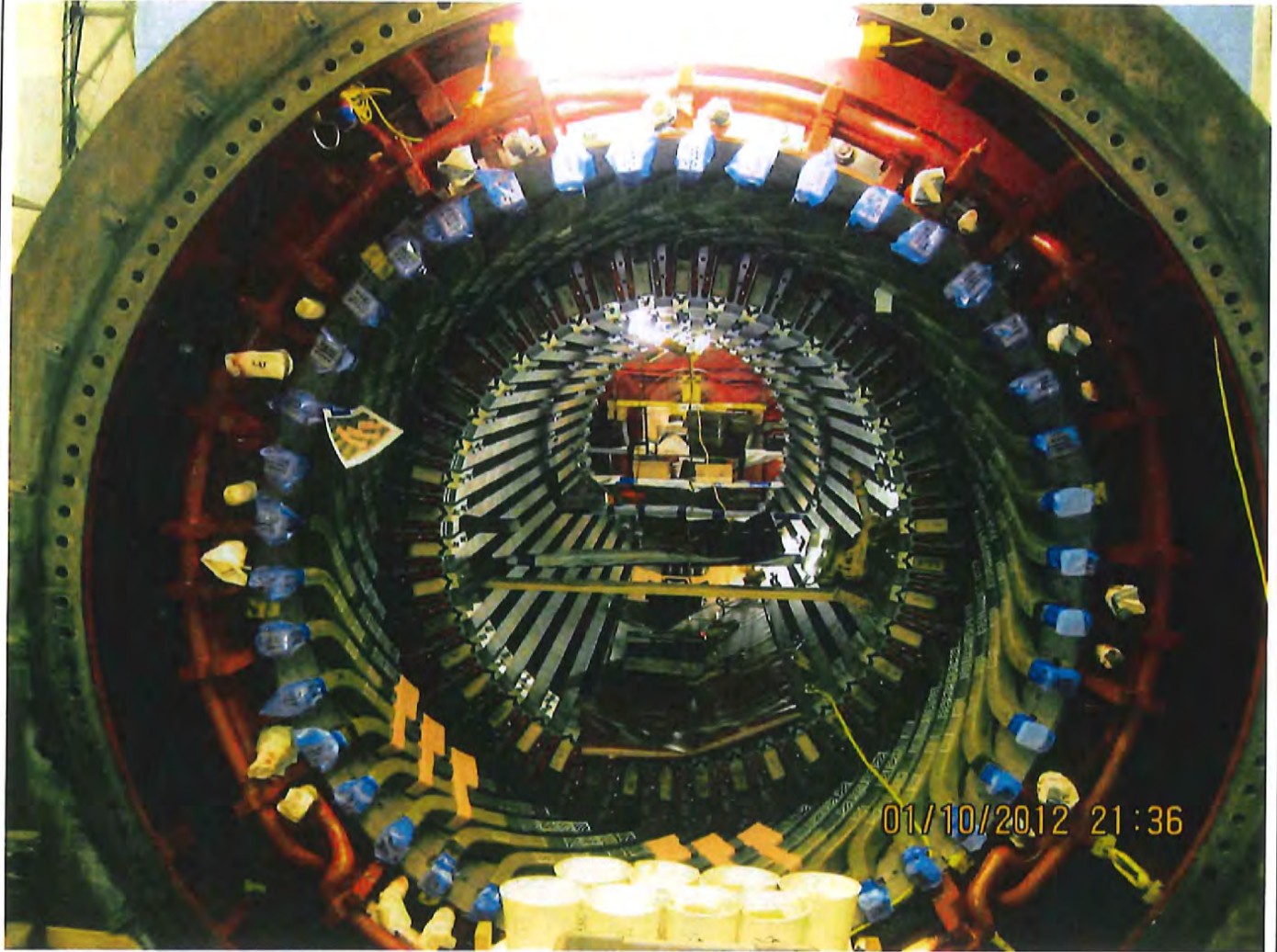



Figure 3 – Top Half-Coil Installation

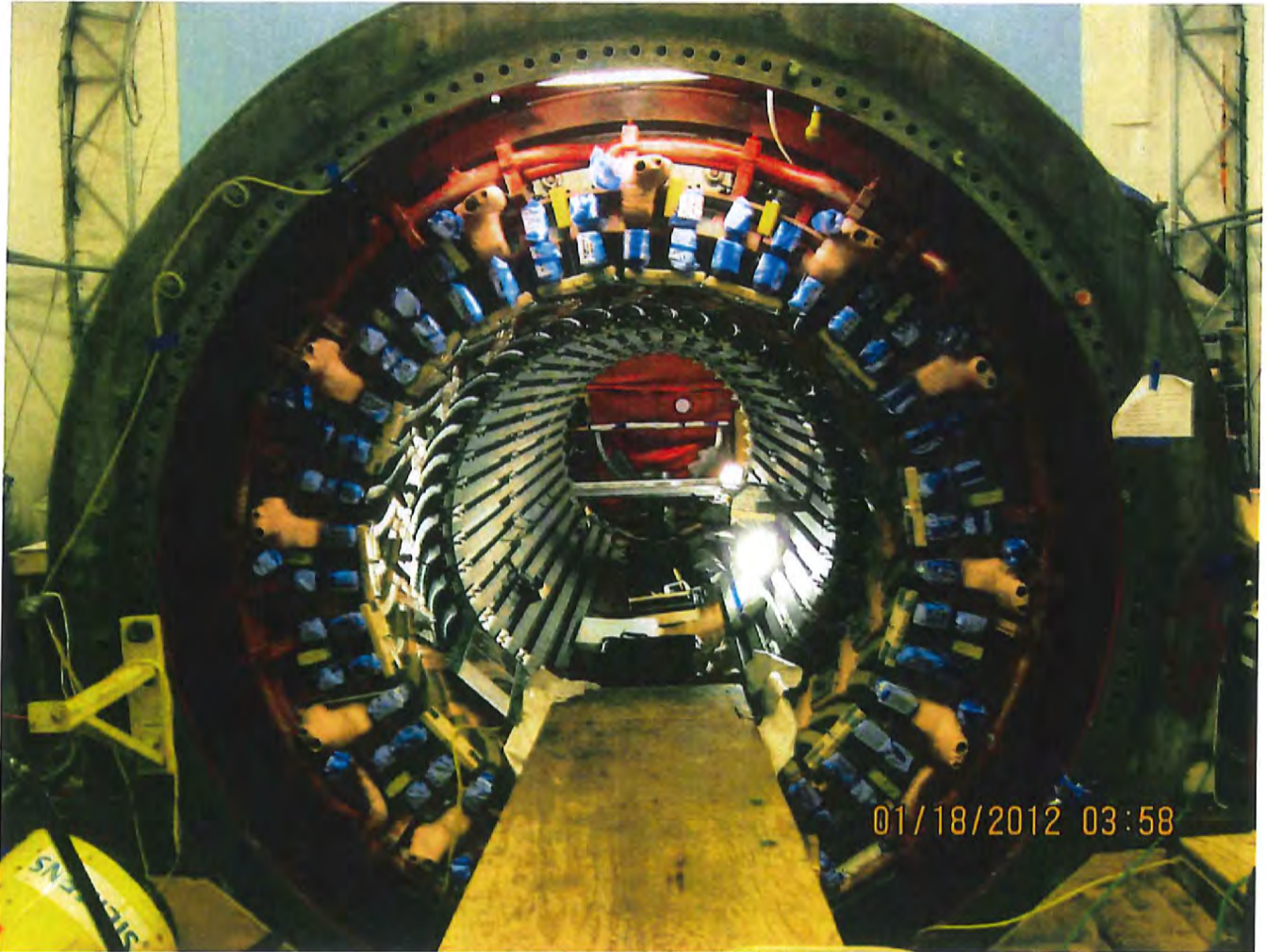

Figure 4 – Coil End Connections

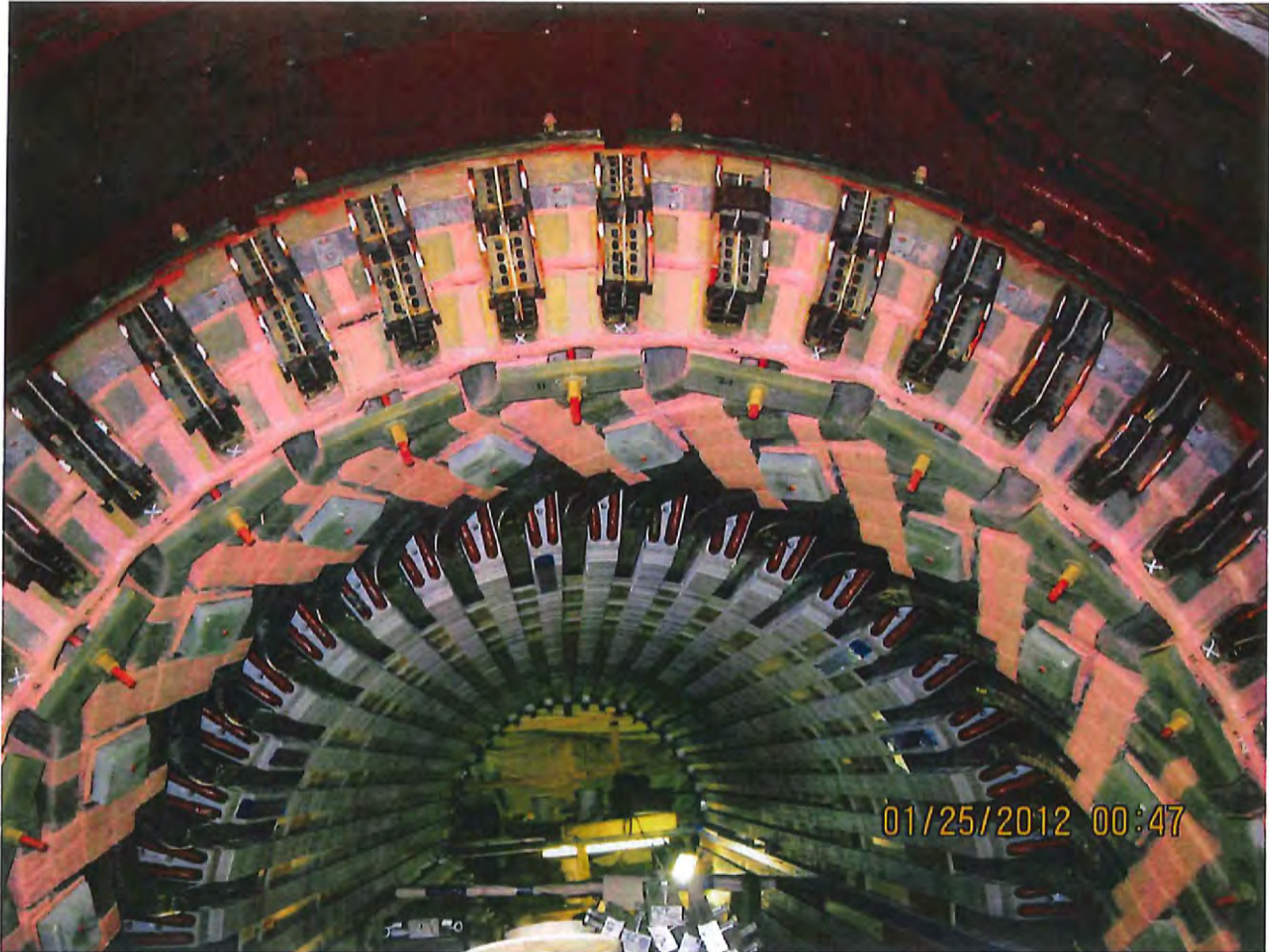



Figure 5 – Stator Bar Section

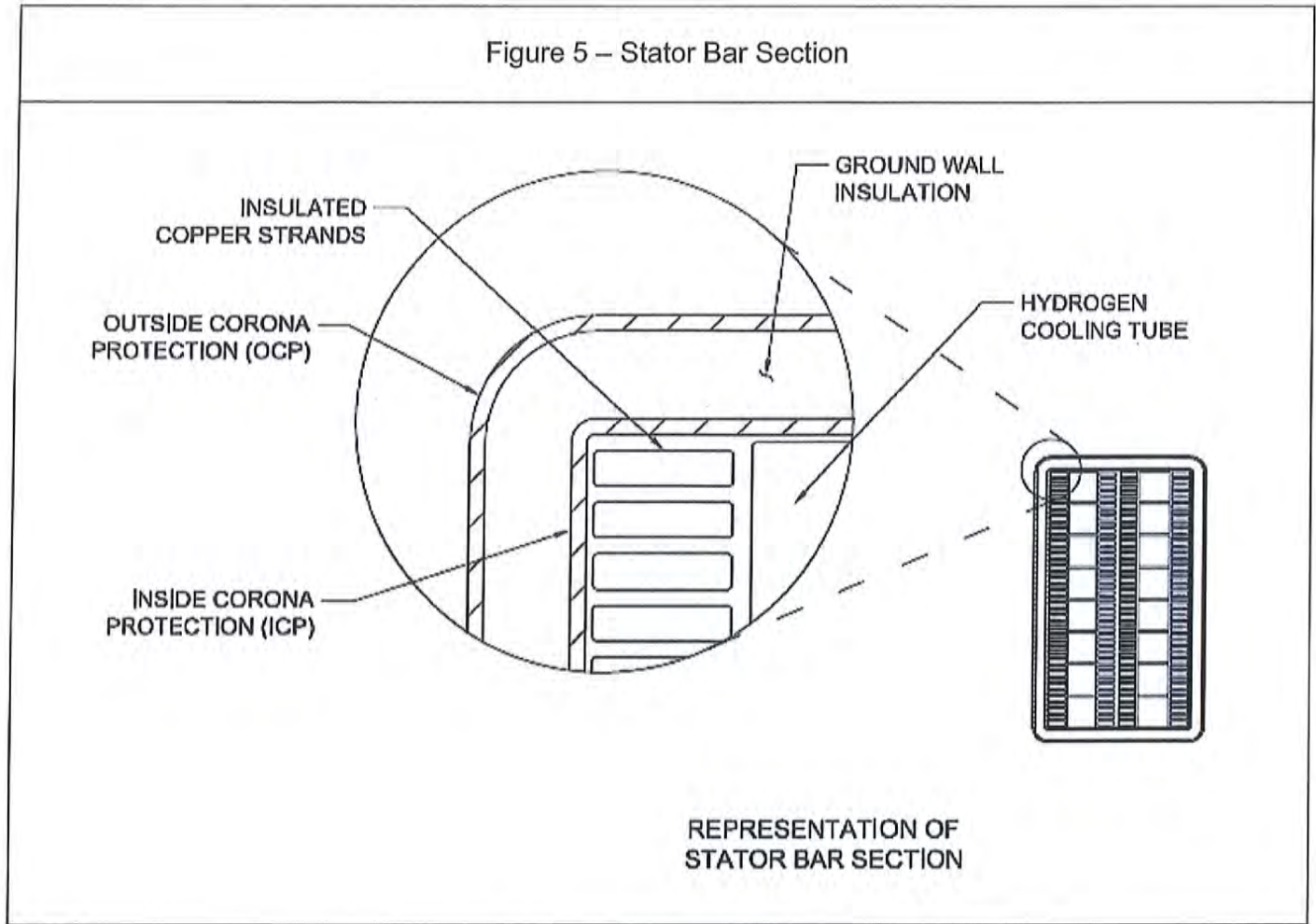

Figure 6 – Section of Stator Bar Removed from Unit 1 Generator 2019 Rewind





Unit 1 Main Generator Ground Fault RCE

AR 02312208

**B. Fault Tree Analysis and Support Refute Matrix**

Many failure processes (mechanical, thermal and electrical) have been documented which can ultimately lead to a ground fault in the stator of a generator. The Fault Tree presented in Attachment B was developed to investigate a range of possible causes for each of these failure processes. The fault tree reflects input from relevant EPRI and IEEE publications on rotating electrical machines and their insulation systems [D16,D17,D20].

Evidence supporting or refuting each failure was captured in the Support Refute Matrix presented in Attachment C. Evidence available at the time of this interim report is limited to field test data and observations captured during the generator rewind. This available data has proven insufficient to determine the dominant failure process; therefore, various potential causal factors remain open. Additional lab tests are planned to identify the specific failure process and ultimately lead to the underlying causal factors. These additional activities [D31], which will be carried out at a Siemens testing facility, are described in the testing schedule provided as Attachment E.

**C. Event and Causal Factors Analysis**

The Event and Causal Factors Chart is presented in Attachment D. The chart includes documented history of the Unit 1 main generator since the generator rewind completed in 2011 for Extended Power Uprate, refueling outage SL1-24.

No significant generator maintenance activities have been performed since the rewind. In 2013 an RTD replacement activity was completed during refueling outage SL1-25. A High Potential Test of the generator was completed after reassembly in SL1-25 with satisfactory results. Crawl through inspections were performed in 2015, 2016, 2018 outages. During the SL1-27 outage in 2016 a ground condition was measured during insulation resistance testing; this was caused by water intrusion in the neutral ground transformer bushing [D28,D29].

Unit 1 Main Generator Ground Fault RCE

AR 02312208

4. Causal Factor Categorization

- A. Address each category - People, Programmatic, Organizational and Equipment based on the analysis.

Extensive experience in the evaluation of insulation aging and failure has been documented. The various important failure mechanisms are generally separated into those of the rotor, the stator windings, and the core laminations. Most or all of the various mechanisms may be acting on the generator however certain dominant mechanisms will ultimately determine the life of the insulation in these components. [D20] In addition, the main factors that determine the dominant failure mechanism have been suggested based on the industry experience (e.g. the likely causes to consider as a minimum). These are design, quality of manufacture, the operating environment (both the physical environment and the operating conditions and duty) and maintenance.

Sufficient evidence has been provided to demonstrate that the generator ground resulted from failure of the ground wall insulation of stator bar B17 in the phase C stator winding. However, this is considered as a more specific direct cause relating to the equipment. The dominant mechanism that influenced premature failure of the ground wall insulation is still under investigation pending further examination and testing of the subject stator bar (Attachment E). Pending this determination, the underlying causal factors remain unclear.

- B. Based upon the above documentation, categorize the results using the Causal Factor Characterization Matrix below.

<b>Causal Factor Characterization</b> (Each causal factor identified is listed and classified in the appropriate People, Programmatic, Organizational and Equipment categories.)		
<b>Cause Type</b>	<b>Cause Statement</b>	<b>Category</b>
Direct Cause	Failure of the ground wall insulation of stator bar B17 in the phase C Stator Winding	Equipment



## Unit 1 Main Generator Ground Fault RCE

AR 02312208

**Interim Causal Factor determination**

Ground wall insulation failure of Stator Bar B17 in the Phase C Stator Winding

Summary

The field testing performed on the Phase C Generator Stator coils demonstrated that the ground fault was located in the bottom stator bar in slot 17 of the stator. The insulation failure resulted in a circuit path to ground from the inner corona protection (ICP) layer of the bar sufficient to operate the generator ground protective relaying. Care was used for removal of this stator bar during disassembly of the stator. Initial visual inspections and field resistance tests confirmed the fault occurred due to an insulation breach located just outside the stator slot on the turbine end. The breach has the appearance of crack in the underlying insulation. The surrounding OCP layer material was degraded and carbon tracking is noted along the adjacent surface areas.

A determination of why the ground wall insulation failed on B17 and at this location requires further evaluation. The failure is significantly premature given the in service time, and appears limited to a localized insulation breach in this specific bar. The failed B17 bar and several control bars were quarantined pending additional forensic testing necessary to establish the failure process and complete the root cause analysis. The summary of proposed forensic testing D31 has been developed and referenced to various open items in the Support Refute Matrix provided in Attachment C.

Supporting Information

- 1) The St Lucie Unit 1 Main Generator is a Siemens/Westinghouse hydrogen intercooled unit rated 1200MVA. [D22]
- 2) A complete rewind and rotor replacement was completed for the St Lucie Unit 1 Generator for Extended Power Uprate during the SL1-24 refueling outage [D19]. The uprated generator was required to meet a new output of 1200 MVA, 22 kV, 1800 rpm at 75 psig hydrogen pressures [D21]
- 3) The Unit 1 generator ground fault lockout occurred on 04/25/2019 during the performance of a reactive capability test of the generator. The testing was being performed in accordance with procedure 0-OSP-53.01. The unit was operating at 100% reactor power. The generator was producing 1055MWe (gross) with 255MVAR (lagging) when the lockout occurred. During the test, Unit 2 was operating at -100MVAR (leading) to compensate for the excess reactive output from Unit 1. Generator terminal voltage was 22.7kV. [D1,D4, D6]

## Unit 1 Main Generator Ground Fault RCE

AR 02312208

- 4) The generator upgrade specification [D21] addressed an expected 40 year service life – “The uprated main generator, refurbished/rewound exciter rotor as well as the hydrogen coolers, exciter coolers, main leads, bushings and current transformers shall be designed for suitable operation for a minimum service life of 40 years under power uprate conditions”.
- 5) The generator upgrade specification [D21] describes technical requirements for the stator windings and insulation:

*The stator coils shall be gas inner-cooled, single turn, half coils wound in open slots and secured in place by Kevlar coated molded glass-epoxy wedges. Each stator coil shall be made up of two half coils shaped on a former and joined together after assembly in the slots.*

*The stator coils shall be composed of solid copper strands in insulated ventilation tubes. Each stator coil strand shall be made of annealed tough pitch copper wire. All individual strands shall be insulated with a double thickness of continuous filament Dacron-Glass fibers having suitable thermal properties, high thermal stability and high abrasion resistance.*

*The coils shall utilize the latest stator coil construction materials, which include internal and external voltage grading material to improve the dielectric performance.*

*A glass backed mica paper tape and epoxy resin, rated for Class F insulation (155°C hot spot temperature limit) and working to Class B (130°C hot spot temperature limit) shall be used to provide the ground wall insulation of the stator coils superior dielectric and mechanical properties. The vacuum-pressure-impregnation (VPI) process shall be utilized.*

*The glass-backed mica paper tape shall be machine-applied over the entire length of the coil, straight part and end arms.*

*Prior to vacuum pressure impregnation, each coil shall be subject to a pre-heat cycle that removes residual moisture.*

*The coils shall be placed into an impregnation pan that shall be inserted into a tank, where a vacuum shall be drawn prior to introduction of the epoxy impregnation resin. Following impregnation, the coils shall be wrapped with a release film barrier and then placed into presses for curing in an oven.*



## Unit 1 Main Generator Ground Fault RCE

AR 02312208

- 6) The Siemens generator documentation [D22] includes a topical description of the Armature Coils:

*The copper strands which make up the armature coils are transposed internally, by means of Roebel transpositions, so that eddy currents will be reduced. A series of high resistance alloy vent tubes extend throughout the length of the coil to provide paths for the flow of hydrogen which cools the coil. The coils are made in halves, and the ends are connected with an additional transposition to eliminate eddy currents arising from end flux effects and to eliminate circulation of the currents due to radial fluxes passing thru the coils in the end zone.*

*The stator coils are insulated with THERMALASTIC insulation. To suppress the corona activity, the portions of the coils embedded in the slot are treated with a semi-conducting tape. A gradient tape is applied to portions of the end turns as well.*

- 7) Insulation resistance testing of the generator was performed by site maintenance electricians during the post event investigations to verify the ground condition. The generator failed the initial 500Vdc test attempt after achieving only 9Vdc test voltage, demonstrating a ground internal to the generator. The ground resistance was measured as 1.88kOhm using a Digital Multimeter. Separation of the generator neutral connections was then performed and the testing repeated on each phase. This testing confirmed C Phase of the generator was grounded. [D13,D14]
- 8) Internal inspection of the generator Lead Box was performed with no findings. Siemens staff performed internal disassembly to isolate the C Phase generator leads from the respective line and neutral bushings for additional Insulation Resistance tests. This testing demonstrated that the ground was located in the generator stator. Insulation Resistance Tests performed on the bushings were satisfactory. [O1,D14,D15].
- 9) Generator crawl through inspection was performed with no findings. Siemens staff performed a voltage drop test from each end of the C Phase Stator winding to ground. The purpose of the test was to determine the relative location of the ground fault from interpretation of the voltage drops as a function of the circuit length through the stator. This test indicated the fault was likely in a particular coil close to the turbine end of the stator. After breaking connections between individual Stator Bars it was determined the Bottom Bar in Slot 17 of the stator was grounded. [O3]

## Unit 1 Main Generator Ground Fault RCE

AR 02312208

- 10) Additional testing of Stator Bar B17 insulation layers was performed to characterize the ground condition. The ICP layer in the stator bar contains a drain conductor that is connected to a strand at one end the stator bar such that the individual strand insulation is bypassed. The drain conductor was disconnected and low voltage insulation resistance testing was performed. This testing confirmed that the stand insulation was intact. [O3]
- 11) Operating voltage of the stator winding conductors increases from the neutral terminal to the line terminal with each turn through the stator. The B17 Stator Bar is electrically close to the generator neutral. Schematics and winding diagrams for the stator are proprietary. Siemens has anecdotally indicated that this bar operates at approximately 3000V, as compared to 12.7kV at the line terminal.



Unit 1 Main Generator Ground Fault RCE

AR 02312208

12) Stator Bar T17 was removed allowing in-situ inspection of bar B17 in the slot. At the time of inspection there was no obvious indication of the fault. [O2]

Several pictures taken during the inspection show the area subsequently confirmed to be the location of the fault just outside of the slot in the stator core laminations. Subtle tracking marks are evident from close review as shown below, though they are somewhat obscured by the gradient taping and paint applied at the end winding area.

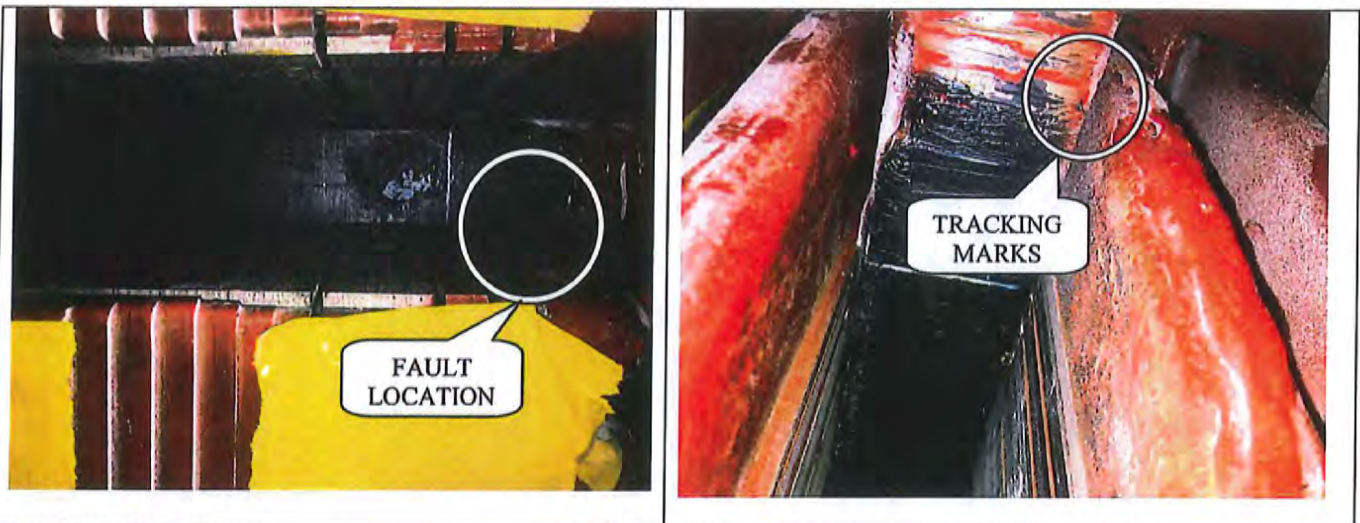

Close-up View:

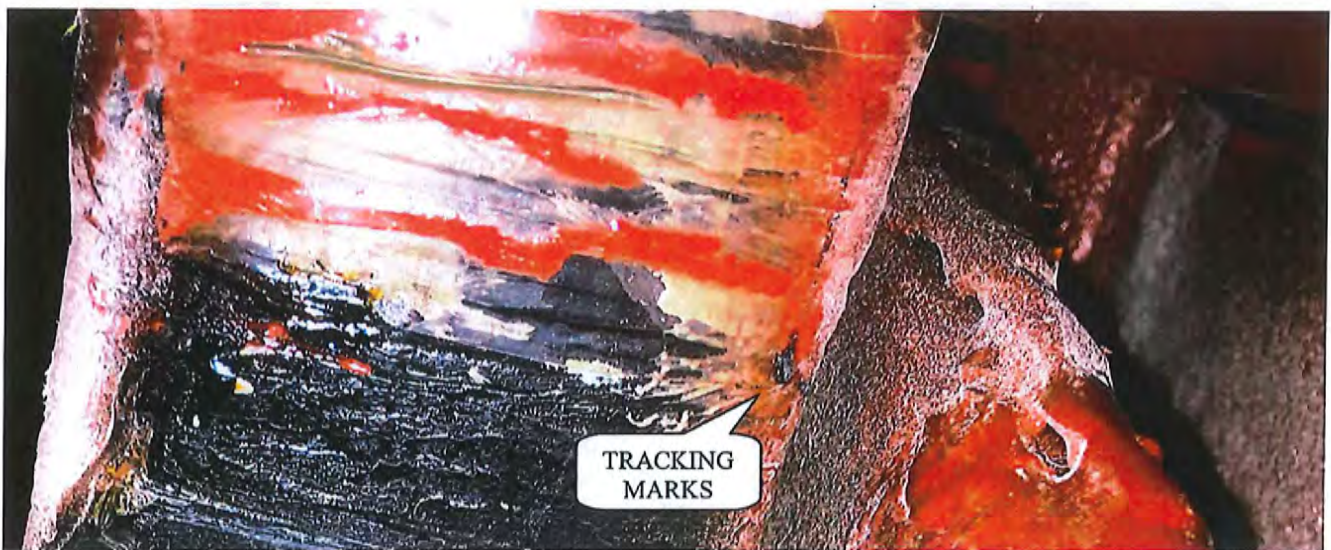



Unit 1 Main Generator Ground Fault RCE

AR 02312208

13)After stator bar B17 was carefully removed from the generator the area of the fault was apparent from visual inspection [O3]

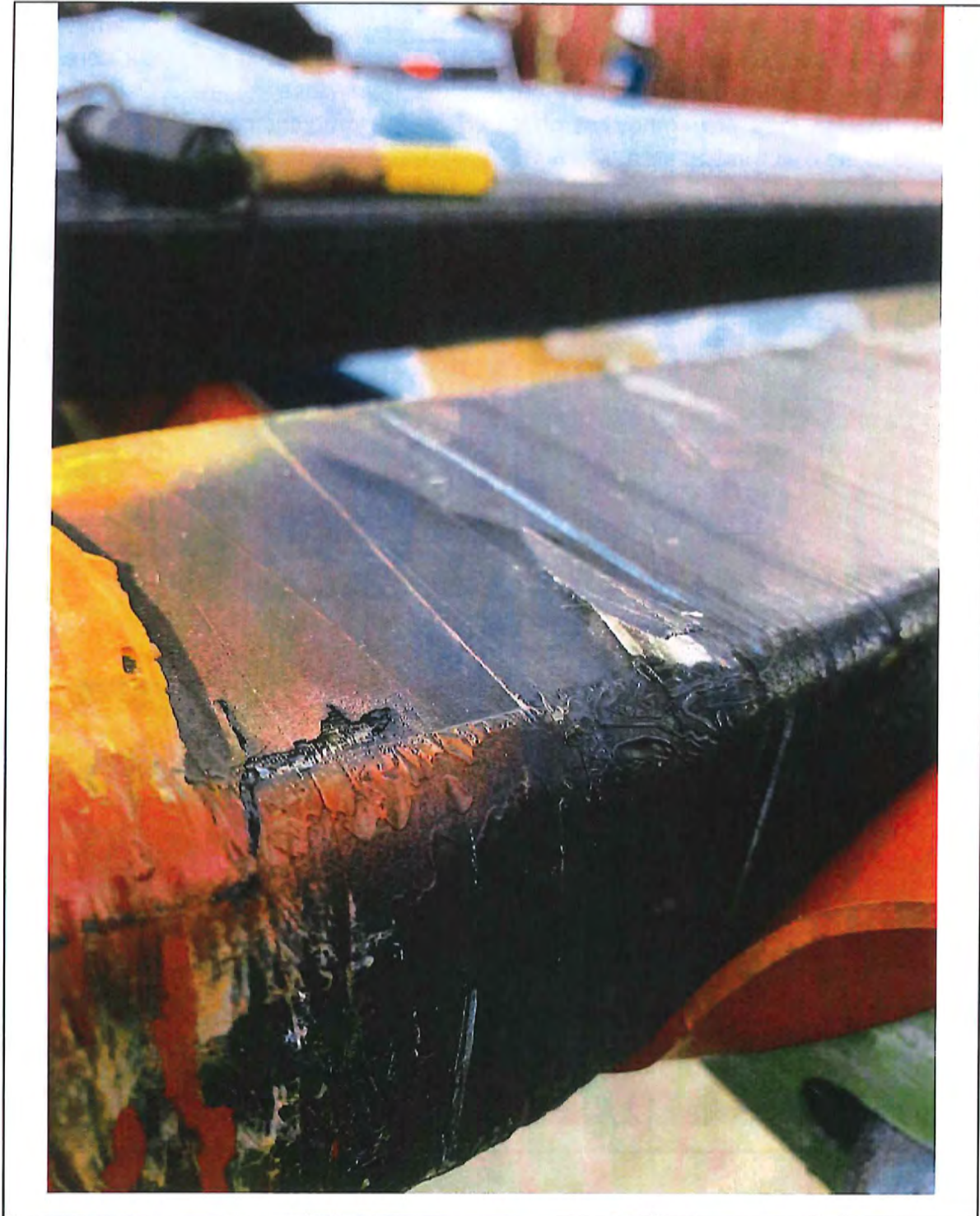



Unit 1 Main Generator Ground Fault RCE

AR 02312208

5. Evaluation Attributes

A. Previous Occurrences

The generator ground fault event is not a repeat occurrence. However, a review of previous events in the context of a Root Cause is not possible in this interim report. Previous occurrence will need to be addressed in the final evaluation report.

B. Extent of Condition

**Identified Problem** – The Extent of Condition (EOC) reviews for generator ground failures.

Object: St Lucie Unit 1 Main Generator

Defect: Grounded stator winding

Consequence: protective relay actuation and generator lockout

**Same / Similar Analysis**

<b>Same Object:</b> Unit Main Generator	<b>Same Defect:</b> Grounded stator winding	<b>Same / Same:</b> St Lucie Unit 2 Main Generator
	<b>Similar Defect:</b> Stator Winding insulation failures: Phase to Ground Phase to Phase	<b>Same / Similar:</b> Other types of fault paths through insulation failures to the stator are considered
<b>Similar Object:</b> Generators and Motors with similar stator configurations		<b>Similar / Similar:</b> Emergency Diesel Generators and other large motors used on site are subject to electrical faults due to

An insulation resistance test, polarization index test, and high potential test, are standard tests for determining insulation condition in a motor or generator.

The scope of extent of condition reviews the St Lucie Unit 2 Main Generator for present insulation condition to ensure there is no current vulnerability for a fault. The Unit 1 and 2 Generators are provided with ground protective relays that will lockout the unit in the event of a ground fault. The units are also provided with differential protective relays that will lockout the unit in the event of a phase to phase type fault.

## Unit 1 Main Generator Ground Fault RCE

AR 02312208

For purposes extent of condition for this event the reviews will be limited to Unit 2 Main Generator. Although electrical insulation system of any motor or generator could have a failure resulting in a fault, due to their size and scale the stator designs and protection system arrangements of the Unit Main Generators are unique in construction using half coil bars and complex arrangements for cooling. The Emergency Diesel Generators and all Medium Voltage motors used on site are relatively simple air cooled machines using form wound coils for stator windings. None of these machines have a stator construction similar to the Unit generators. In addition, the electrical systems (6.9 and 4.16kV) these machines are connected to have high impedance grounding with alarm, but no automatic tripping in the event of a ground fault.

**Extent of Condition Review**

EOC Action – review most recent insulation condition tests for the Unit 2 generator to determine if adequate confidence is provided for the current condition of the stator winding insulation. If necessary, ensure insulation condition tests are scheduled for next opportunity.

An inspection of the St Lucie Unit 2 generator was performed during the most recent SL2-24 refueling outage in 2018. This work included a generator crawl-through inspection, tuning weight inspection, exciter rotor swap out and electrical inspection, and rotor radial lead hardware upgrade. The generator was partially disassembled for this inspection and the rotor was removed [D18]. Electrical tests were performed including, insulation resistance test, polarization index test, and high potential test to 48,000Vdc. To the extent that the Unit 2 generator passed these tests and insulation successfully withstood the high potential test voltage it can be concluded there that a similar ground fault was not present and is not likely in the near term.



Unit 1 Main Generator Ground Fault RCE

AR 02312208

**C. Extent of Cause**

The extent of cause will need to be addressed in the final evaluation report after determination of the root cause.

**D. Safety Culture Evaluation**

The safety culture evaluation will need to be addressed in the final evaluation report after determination of the root cause.

**E. Risk/Consequence**

The main generator is not safety related. However, a generator lockout turbine trip initiates a Loss of Load actuation in the Reactor Protection System (RPS) and results in an automatic reactor trip.

The operational crew entered 2-EOP-01, Standard Post Trip Actions, and then transitioned to 2-EOP-02, Post Trip Recovery. All CEAs fully inserted into the core and the trip was uncomplicated with all safety functions satisfied. The plant established in Mode 3 Hot Standby. Nuclear Regulatory Commission (NRC) was notified of the event per 10CFR 50.72(b)(2) due to RPS Actuation.

The ground fault was located in an inaccessible location of the generator stator and the affected stator bar assessed as unrepairable in place. An emergent Generator rewind was undertaken. This evolution has resulted in over 30 days of unplanned energy loss (UEL) beginning 4/25/19.

The event did not impact the environment and there were no radiological or security related implications

Unit 1 Main Generator Ground Fault RCE

AR 02312208

6. Operating Experience

A preliminary OE search and review was completed for generator ground faults.

INPO TR4-38	Topical Report - Review of Main Generator Failures
OE #103441	Braidwood Unit 1 REACTOR TRIP CAUSED BY MAIN GENERATOR PHASE C GROUND FAULT
OE #312004 (WANO)	Novovoronezh 5 Protection Actuation on a Ground Fault in Turbine Generator Stator Winding Caused a Main Generator Trip and Subsequent Unit Load Reduction
OE #287412	Sequoyah Unit 1 TURBINE TRIP (POWER > 50%) A MAIN GENERATOR GROUND FAULT CAUSED A TURBINE TRIP WHICH CAUSED A REACTOR TRIP BECAUSE REACTOR POWER WAS ABOVE 50%. THE GROUND FAULT WAS CAUSED BY INSULATION BREAKDOWN ON THE "C" PHASE STATOR BAR T-17
OE #102142	South Texas Unit 1 Reactor Trip Due to a Generator Ground Fault Relay Actuation Caused by a Stator Coil End Turn Failure

Based on the information reviewed to date there is no OE directly relevant to the event. A review to determine how relevant OE was screened / evaluated at the site will need to be performed in the final evaluation report to assess effectiveness of the OE program.

INPO IER L2-11-2 Scram Analysis:

The Main Generator is an SPV component, therefore Recommendation 2 of IER L2-11-2 pertaining to SPV elimination and mitigation strategies is directly applicable. The Main Generator has been classified as an SPV/FID1. The St. Lucie scram analysis response has credited SPV mitigating strategies including preventive maintenance, replacement, and design modification.

SPV elimination is not credible for the generator, however the uprate completed in 2012 addressed both replacement and modernization improvements. Various preventive maintenance activities address the generator. By its nature the activities for the stator are limited to monitoring (inspect and test) activities, however these are consistent with industry practice. No gaps in this area are apparent based on interim evaluation. A further review is warranted in the final evaluation report..



## Unit 1 Main Generator Ground Fault RCE

AR 02312208

**7. Lessons Learned**

Prior to the generator ground fault event, various preventive measures were established associated with the performance of Reactive Capability testing. These included review of various performance and diagnostic data from the generator available before the test, and online monitoring performed during the test (vibration, thermography etc.) This data has been reviewed and it provided no indications of the degrading insulation condition which resulted in the ground fault.

**8. Proof Statement:**

The proof statement will be addressed in the final evaluation report after determination of the root cause

**9. Corrective Actions**

Area	Corrective Action/Assignment	Responsible Maintenance Programs	Assignment Type	Due Date
Direct Cause - Ground wall insulation failure of Stator Bar B17 in the Phase C Stator Winding	Complete rewind of the Unit 1 generator to restore stator winding to serviceable condition.		CA	By Work Management Process - Forced Outage Schedule
Interim - Forensics Testing	Track completion of forensics testing as prescribed in Attachment E	RCE Sponsor Mark Jones	MA	7/12/19
	Re-establish Root Cause Team to complete final Evaluation based on findings of forensics testing. Revise RCE Charter with updated team scope and schedule	RCE Sponsor Mark Jones	MA	7/19/19
Extent of Condition- Unit 2 Generator	Review maintenance history for Unit 2 Generator to determine near term risk for stator insulation resistance	Root Cause Team	CA	COMPLETE

**10. Deferral Justification**

This report provides an interim evaluation. As such specific CAPR and CA are deferred for the final report in accordance with PI-AA-100-1005

**11. Effectiveness Review Plan**

The EFR plan will be addressed in the final evaluation report after determination of the root cause



## Unit 1 Main Generator Ground Fault RCE

AR 02312208

## 12. Sources Cited

## Documents:

#	Document Title
D1.	AR 02312208 UNIT 1 AUTOMATIC REACTOR TRIP
D2.	AR 02312219 NRC Notification
D3.	AR 02312560 LER
D4.	0-OSP-53.01 "Reactive Power Lagging Capability Test" performed 4/25/19
D5.	Turbine Generator Vibration Summary for Lagging Test 4/25/19
D6.	U1 Ops Narrative Logs April 25, 2019
D7.	Enterprise Wide Information System (EWIS) St Lucie Data / PI Process Book
D8.	8770-B-327 sh890
D9.	8770-B-327 sh1250
D10.	WO 40066477 SL1-248 Generator Rewind (EPU)
D11.	WO 40168563 SL1-25 Rotor Inspection
D12.	WO 40272487 SL1-25 Generator High Pot
D13.	WO 40661261-10 U1 GEN MAIN ACCESS LEAD BOX FOR MEGGER - FAR 10
D14.	Summary of Failure Investigation Process Field Actions and Results
D15.	WO 40661017-18 U01 GENERATOR MEGGER TEST FIP - FAR 3
D16.	EPRI EL-5036 "Power Plant Electrical Reference Series, Volume 1 Electric Generators"
D17.	EPRI EL-5036 "Power Plant Electrical Reference Series, Volume 16 Handbook to Assess Insulation"
D18.	Siemens Customer Report for St Lucie Unit 2 Generator September 2018
D19.	EC 246457 "UNIT 1 GENERATOR ROTOR REPLACEMENT AND STATOR REWIND"
D20.	IEEE Press "Electrical Insulation for Rotating Machines" by Stone, Boulter, Culbert, Dhirani
D21.	Specification SPEC-E-037 Rev. 3 "Main Generator and Exciter Upgrade"
D22.	Manual 8770-4139 Rev. 17 "Siemens Hydrogen Inter-cooled Turbine Generator"
D23.	Siemens Customer Report for St Lucie Unit 1 Generator Rewind and Core Replacement completed February 2012
D24.	WO 40011327 SL1-24 Generator Rewind
D25.	Siemens Customer Report for St Lucie Unit 1 Generator October 2013
D26.	PSDS Field Data
D27.	WO 40503468-01 SL1-28 Generator Grounding and Testing
D28.	WO 40391932-01 SL1-27 Generator Grounding and Testing
D29.	AR 02167611-01 CE SUPPLEMENT TO AR 2167433 LOW GEN MEGGER
D30.	Understanding Generator Ground Faults
D31.	Siemens Testing Summary and Acceptance Criteria [proprietary data]
D32.	WO 40168563-01 SL1-25 Rotor Insp.
D33.	Siemens Customer Report for St Lucie Unit 1 Generator 2015
D34.	Siemens Customer Report for St Lucie Unit 1 Generator 2016
D35.	Siemens Customer Report for St Lucie Unit 1 Generator 2018

Unit 1 Main Generator Ground Fault RCE

AR 02312208

Observations:

#	Observation
O1.	Generator Crawl through field notes/pictures
O2.	Top Coil Removal and slot inspection field notes/pictures
O3.	Slot 17 Bottom Coil Removal and field notes/pictures
O4.	



Unit 1 Main Generator Ground Fault RCE

AR 02312208

**13. Attachments**

- A. Root Cause Charter**
- B. Fault Tree Analysis**
- C. Support Refute Matrix**
- D. Event and Causal Factors Chart**
- E. Siemens RCA Lab Testing Plan and Schedule**

**ROOT CAUSE CHARTER**

**Facility:** St. Lucie Nuclear  
**Condition Report:** 2312208  
**Manager Sponsor:** Mark Jones (Engineering)

**Event Description**

At approximately 0918 on 4/25/2019, Unit 1 reactor and turbine automatically tripped due to a Main Generator ground.

**Preliminary Problem Statement**

**Object:** U1 Main Generator  
**Defect:** experienced a phase to ground electrical fault  
**Consequence:** resulting in an automatic reactor and turbine trip.

**Preliminary Extent of Condition**

**Extent of condition** preliminarily defined as U2 Main Generator.  
**Extent of cause** preliminarily defined as U1/U2 Main Turbine and U1/U2 Main Generator

**Investigation Scope and Methodology**

At a minimum, the RCE shall address the following:

- Root and Contributing Causes
- Extent of Condition and Extent of Cause
- Corrective Actions and Effectiveness Measures

The following investigation methodologies shall be considered for use by the RCE team:

- Hazard/Barrier/Target Analysis
- Event and Causal Factor Charting
- Organizational and Programmatic Failure Analysis

**Team Members**

**Team Leader:** A. Bouchfaa (Engineering)  
**Team Root Cause Evaluator:** Gary Arntson (Engineering)  
**Team Member:** Andy Terezakis (Operations)  
**Team Member:** Don Zoll (Electrical Maintenance)

**Milestones**

**Date Assigned:** 05/06/2019  
**Status Update:** 05/20/2019  
**Draft Report Date:** 05/31/2019  
**Final Report Date:** 06/05/2019

**Communications Plan:** Weekly updates to MRC. Daily updates will be provided during the early, critical discovery phase of deconstruction and repairs.

**Sponsor Approval:** Mark Jones Date: 5/30/2019

**MRC Approval:** Don Zoll Date: 5/31/19



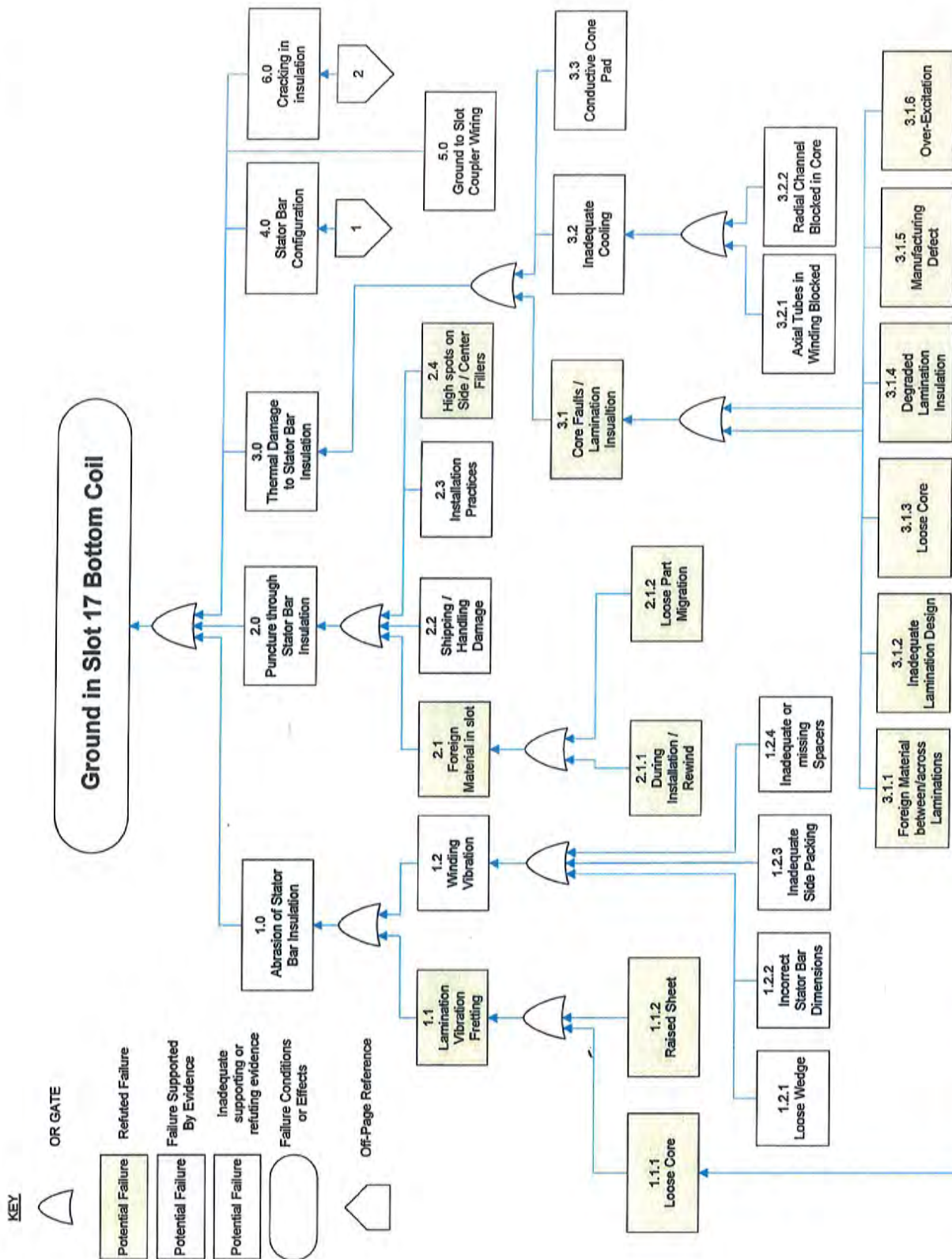

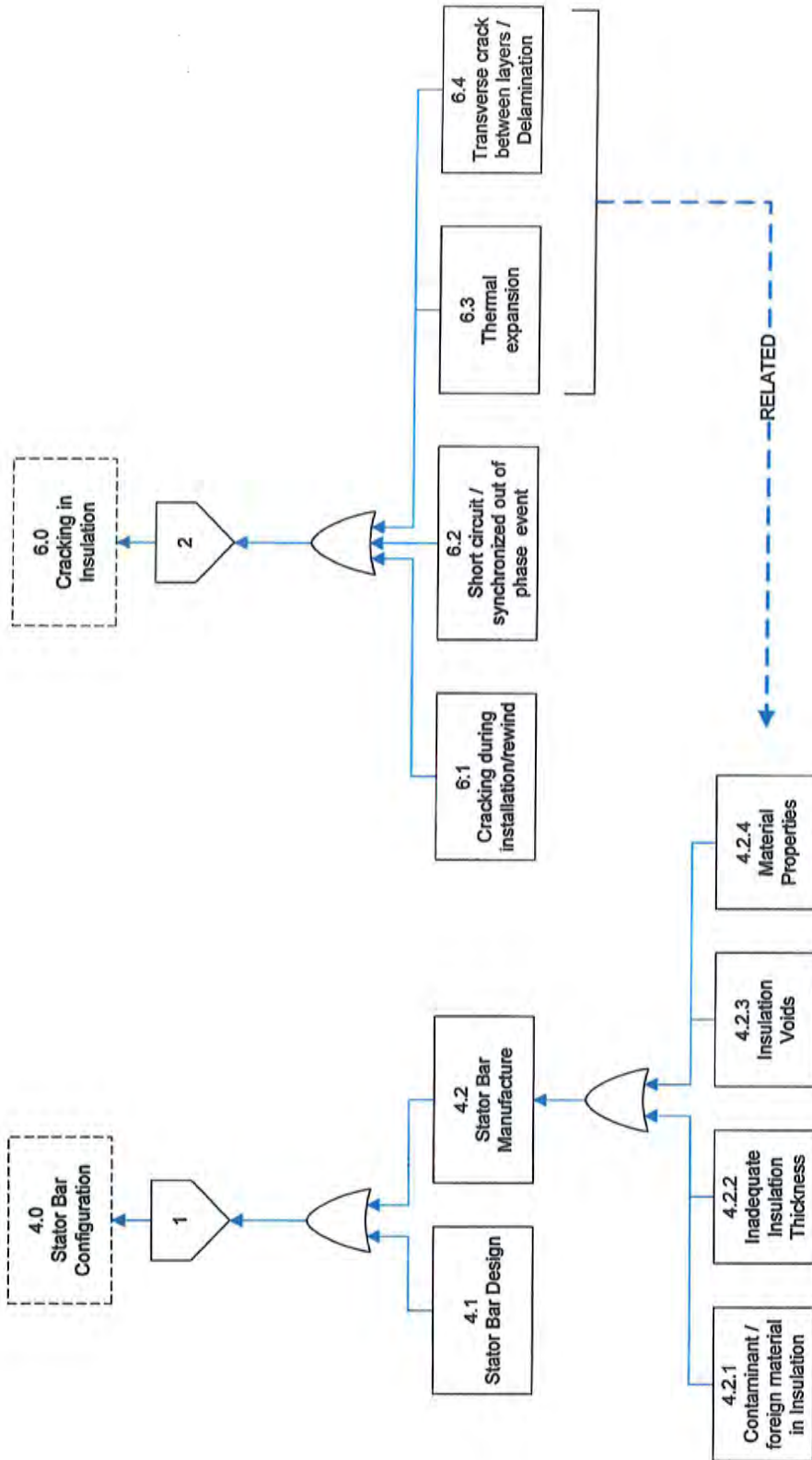



Support / Refute Matrix

Failure Mode # 1 – Abrasion of Stator Bar insulation					
CAUSE	VERIFICATION	EXPECTED / NORMAL	ACTUAL	CONCLUSION	NOTES
1.0					
1.1	Determine if fretting of insulation is present on stator bar insulation: 1. Field visual inspection of slot 17 stator bars before and after removal 2. Field visual inspection of slot 17 after stator bars and fillers are removed	No significant evidence of insulation damage due to fretting as indicated by greasing or dusting indications on bars or in slot	External inspection of the top and bottom bars from slot 17 was completed. Inspection of stator slot 17 was completed after bar removal. No evidence of fretting was identified and no indications were found for a raised lamination [O2,O3]	This failure mode can be refuted. No evidence supporting lamination vibration has been noted.	Initial Visual observation of bottom 17 bar shows indication of ground fault outside of the slot area on turbine end.
1.1.1	See 3.1.3				
1.1.2	Perform visual inspection with check by feel for raised lamination in slot 17	Sheets properly aligned in core stack			
1.2	Determine if indications of insulation abrasion due to vibration are present: 1. Field visual inspection of slot 17 stator bars before and after removal	No significant evidence of rubbing or wear through insulation damage due to vibration of the bar within the slot or out of slot at the end turns	Field inspection of the top and bottom bars from slot 17 was completed. There were no obvious indications of insulation abrasion.	This failure mode appears unlikely based on available evidence however RCE team believes additional testing is required to refute.	Pending result of Siemens Lab Testing Attachment E

Support / Refute Matrix

Failure Mode # 1 – Abrasion of Stator Bar insulation					
CAUSE	VERIFICATION	EXPECTED / NORMAL	ACTUAL	CONCLUSION	NOTES
1.0					
1.2.1	Perform PSDS (pre stress driving strip) Wedge Tightness	PSDS Wedge Tightness within specification	Preliminary review of as-found PSDS deflection data shows the slot 17 wedges were generally consistent for all the wedges and with those of the adjacent wedges [D26].		Material has been collected for further inspection. Assessment of data by Siemens is pending.
1.2.2	Validate bar dimensions after stator bar removal	Stator Bar dimensions within Siemens specifications			Pending result of Siemens Lab Testing Attachment E
1.2.3	Inspect prior to removal and check for bar loose fit in the slot during removal from stator	Assess fit during bar removal from Slot 17. Inspect removed bar and side packing materials for evidence of abrasion	Side packing appeared tight during bar removal.		Side Packing material has been collected for further inspection.
1.2.4	Validate all spacers in place during bar removal from slot	All spacer in place in accordance with Siemens specifications Inspect removed stator bar and spacer materials for evidence of abrasion	Inspection did not reveal any missing spacers. All center fillers were accounted for between top and bottom bars in slot 17. Review of original bump test data indicated no resonances. Initial readings by FOVM were low and further readings were suspended.		Spacer material has been collected for further inspection.



Support / Refute Matrix

Failure Mode # 2 – Puncture through insulation					
CAUSE	VERIFICATION	EXPECTED / NORMAL	ACTUAL	CONCLUSION	NOTES
2.0	Puncture through insulation	Determine if insulation is punctured. 1. Non Destructive CT exam of bar 2. Visual and Microscopic Exam of fault area surface	Insulation is free from indications of puncture damage		Pending result of Siemens Lab Testing Attachment E
2.1	Foreign Material in Slot				
2.1.1	Introduced during Installation/Rewind	Inspect stator bar and slot after removal for evidence of Foreign Material	No foreign materials found in slot during visual inspections	No visually identifiable foreign materials have been found after bar removal from Slot 17	Damage to the insulation due to a foreign material is refuted
2.1.2	Loose Part Mitigation	Additional exam and testing as described in 4.2.1			
2.2	Shipping/ Handling Damage	1. Visual and Microscopic Exam of fault area surface	No puncture or cracking of insulation	The coils passed initial High Potential testing during Bottom coil test, Top coil test and final test at 76500Vdc (110% of coil voltage based on (2E+1) x 1.7)	Pending result of Siemens Lab Testing Attachment E
2.3	Installation Practices	2. Section Bar and perform visual and microscopic exam of insulation at fault	No evidence of localized insulation damage from nonconforming filler materials.	The fault location was identified after bar removal from Slot 17. Insulation damage was identified in a location outside of the slot	
2.4	High spot or anomaly on side fillers or center filler	Visual Exam of stator bar and middle and side fillers from slot 17			Spacer material has been collected for further inspection.

Support / Refute Matrix

Failure Mode # 3 – Thermal Damage to insulation					
CAUSE	VERIFICATION	EXPECTED / NORMAL	ACTUAL	CONCLUSION	NOTES
3.0					
Core Faults/ Lamination Insulation					
3.1	Core Faults/ Lamination Insulation				
3.1.1	Foreign Material between/ across Lamination 1. Perform field inspection of slot 17 laminations 2. Perform core imperfection test (EL-CID/SMCAS)	No heating or tracking indications on slot 17 laminations No significant indications in slot 17 laminations	No evidence of FME or in the core Initial SMCAS after fault does not show significant indications at slot 17	Core faults due to FME in slot 17 can be refuted	No faults found in these locations by SMCAS and Loop tests after 2011 rewind
3.1.2	Lamination Design	Consistent satisfactory condition in all radial sections of laminations adjacent to 17, no systemic indications	The core was found in generally serviceable condition after generator stripping. No evidence of overheating Initial SMCAS after fault does not show any systemic indications. A Loop test has been also been performed finding a consistent thermal response to rated flux and no thermal anomalies present	Design of the laminations can be refuted as a cause	Reactive Capability Testing was underway during the fault. The voltage was only raised by 2.3% and the reactive power was well within the capability curve



Support / Refute Matrix

3.0 Failure Mode # 3 – Thermal Damage to insulation					
CAUSE	VERIFICATION	EXPECTED / NORMAL	ACTUAL	CONCLUSION	NOTES
3.1.3 Loose Core	<ol style="list-style-type: none"> <li>As-found SMCAS</li> <li>Visual inspection after removal</li> <li>Knife test</li> <li>Post-Removal SMCAS (Core Loop Test if indicated)</li> <li>Through bolt tightness checks, visual inspection of Belleville washers</li> </ol>	<p>SMCAS/Knife test within Siemens specifications</p> <p>Visual inspection with no anomalies</p> <p>Bolts tightened to Siemens specification</p>	<p>Some end iron issues were noted that were clearly due to generator stripping activities. No loose core lamination issues for slot 17.</p> <p>Initial SMCAS after fault does not show any systemic indications.</p> <p>A Loop test has been also been performed and no thermal anomalies were present</p>	<p>Core looseness can be refuted as a cause</p>	
3.1.4 Degraded Lamination Insulation	<ol style="list-style-type: none"> <li>Perform field inspection of slot 17 laminations</li> <li>Perform core imperfection test (EL-CID/SMCAS)</li> </ol>	<p>No heating or tracking indications on slot 17 laminations</p> <p>No indications in stator core laminations</p>	<p>The core was found in generally serviceable condition after generator stripping. No evidence of overheating</p> <p>Initial SMCAS after fault does not show any systemic indications.</p> <p>A Loop test has been also been performed finding a consistent thermal response to rated flux and no thermal anomalies present</p>	<p>Satisfactory inspections and testing demonstrates lamination insulation is not degraded</p>	
3.1.5 Lamination Manufacturing	See 3.1.1				
3.1.6 Over-excitation of generator	Review generator data recorded during reactive capability test	Generator Reactive Load (MVAR) and Exciter Amps within capability ratings	Generator was maintained at 255MVAR during the reactive load test.	Generator was maintained within excitation limits	The generator capability limit for the test conditions was 510MVA

Support / Refute Matrix

3.0 Failure Mode # 3 – Thermal Damage to insulation					
CAUSE	VERIFICATION	EXPECTED / NORMAL	ACTUAL	CONCLUSION	NOTES
3.2	Inadequate Cooling				
3.2.1	Ventilation Tubes in Bar Blocked	<ol style="list-style-type: none"> <li>1. Perform borescope inspection of cooling tubes</li> <li>2. Section Bar and perform visual and microscopic exam of insulation at fault</li> <li>3. Review hot gas temperature history data</li> </ol>	<p>cooling tubes are open and free of any debris</p> <p>no outlier in hot gas temperatures prior to fault event, consistent temperature response during reactive capability testing</p>		Pending result of Siemens Lab Testing Attachment E
3.2.2	Cooling Channel Blocked in Core (Axial Channels, plus additional radial channels in step iron)	<ol style="list-style-type: none"> <li>1. Perform field inspection of cooling channels in slot 17 and adjacent slots for blockage</li> </ol>	<p>Stator cooling channels are open and free of any debris</p>		
3.3	Conductive Cone Pad brought high voltage to weak point on affected stator bar	<ol style="list-style-type: none"> <li>1. Visual Exam of cone pad sample</li> <li>2. Insulation Resistance test of cone pad sample</li> </ol>	<p>1000 MΩ/in<sup>2</sup> (1.00 x 109 Ω/in<sup>2</sup>) minimum at 1,000 Vdc or 500 MΩ/in<sup>2</sup> (0.50 x 109 Ω/in<sup>2</sup>) minimum at 5,000 Vdc when measured over a 1in<sup>2</sup> area</p>		Turkey Point OE on conductive cone pad material that resulted in failed high potential testing. St Lucie passed initial high potential testing after rewind



Support / Refute Matrix

Failure Mode # 4 – Stator Bar Configuration						
4.0	CAUSE	VERIFICATION	EXPECTED / NORMAL	ACTUAL	CONCLUSION	NOTES
4.1	Stator Bar Design	Measure and record the insulation resistance (IR) and Polarization Index (PI) of non-faulted stator bar section and on all control sample bars  Additional exam and testing as described in 4.2 may also provide evidence for verification of coil design	Values over 100 Mega-ohms with a PI of at least 2 are considered good for further testing			Pending result of Siemens Lab Testing Attachment E
4.2	Stator Bar Manufacture					
4.2.1	Contaminants / Foreign Material in Insulation	1. Microscopic Exam of fault area surface 2. Section Bar and perform Microscopic Examination of insulation at fault 3. IR Spectroscopy if warranted by inspections	Insulation layer is free of any foreign material or contaminants			Pending result of Siemens Lab Testing Attachment E

Support / Refute Matrix

Failure Mode # 4 – Stator Bar Configuration						
4.0	CAUSE	VERIFICATION	EXPECTED / NORMAL	ACTUAL	CONCLUSION	NOTES
4.2.2	Inadequate Insulation Thickness	<ol style="list-style-type: none"> <li>Section Bar and perform visual and microscopic exam of insulation at fault</li> <li>dimensional measurements of insulation thickness</li> </ol>	<p>Verify lapping configuration and insulation dimensions</p> <p>Configurations and copper and insulation sizes conform with drawings (Siemens)</p>			Pending result of Siemens Lab Testing Attachment E
4.2.3	Insulation Voids	<ol style="list-style-type: none"> <li>Perform tap test on bar</li> <li>Section Bar and perform visual exam of insulation at fault for voids</li> </ol>	<p>Verify lapping configurations conform with drawings (Siemens)</p> <p>Insulation is free from voids</p>			Pending result of Siemens Lab Testing Attachment E



Support / Refute Matrix

Failure Mode # 4 – Stator Bar Configuration						
4.0	CAUSE	VERIFICATION	EXPECTED / NORMAL	ACTUAL	CONCLUSION	NOTES
4.2.4	Material Properties	<p>Sample insulation adjacent to fault location for test</p> <ol style="list-style-type: none"> <li>1. Tensile test</li> <li>2. Glass transition temperature</li> <li>3. Burnout test to measure % organics</li> <li>4. Soxhlet extraction to separate solids from insulation</li> </ol>	<p>No indication of epoxy migration at expected operating temperatures</p> <p>Tensile test requirement: 5,000psi minimum for new coils</p> <p>Glass transition temperature requirement: 70C minimum for new coils</p> <p>% Organics requirement: 18-28% for new coils</p> <p>Soxhlet extraction requirement: 2.5% maximum for new coils</p> <p>Above test results will also be compared to the non-faulted bar</p>			Pending result of Siemens Lab Testing Attachment E

RCE AR 02312208  
Attachment C

Support / Refute Matrix

Failure Mode # 5 – Ground to Stator Slot Coupler						
5.0	CAUSE	VERIFICATION	EXPECTED / NORMAL	ACTUAL	CONCLUSION	NOTES
5.0	Ground to Stator slot Coupler	Inspect Stator Slot Coupler Wiring Perform insulation resistance test at slot coupler	No evidence of wear or damage to insulation along SSC wiring path in stator.  Low voltage IR demonstrates Slot coupler is not grounded to shield			Pending result of Siemens Lab Testing Attachment E



Support / Refute Matrix

Failure Mode # 6 – Crack in Insulation					
CAUSE	VERIFICATION	EXPECTED / NORMAL	ACTUAL	CONCLUSION	NOTES
6.0	Crack in Insulation	Determine if cracking is present in stator bar insulation.  3. Non Destructive CT exam of bar 4. Visual and Microscopic Exam of fault area surface 5. Section Bar and perform Microscopic Examination of insulation at fault	Insulation is free from crack indications		Initial Visual observation of bottom 17 bar shows indication of ground fault outside of the slot area on turbine end.  Pending result of Siemens Lab Testing Attachment E
6.1	Cracking during Installation/ Rewind	Review installation history / Siemens PCMs (internal records) for anomalies	No significant non-conformance with accepted installation practices		Passed High Potential Tests during installation
6.2	Close in Short Circuit event or out of phase synchronization	Review generator operating history	No significant events identified since startup from SL1-24 after rewind		

Support / Refute Matrix

Failure Mode # 6 – Crack in Insulation						
6.0	CAUSE	VERIFICATION	EXPECTED / NORMAL	ACTUAL	CONCLUSION	NOTES
6.3	Crack in operation due to thermal expansion	Evaluate insulation physical properties: exam and testing as described in 4.2.4  Compare properties of bottom 17 stator bar with other in service bars from generator as control samples	See 4.2.4			Pending result of Siemens Lab Testing Attachment E
6.4	Delamination / Transverse cracking between layers	Perform visual examination of bar for delamination of insulation  Inspect sectioned bar: exam and testing as described in 4.2.3 and 4.2.4	See 4.2.3 and 4.2.4			Pending result of Siemens Lab Testing Attachment E



RCE AR 02312208  
Attachment D – Event and Causal Factors Chart

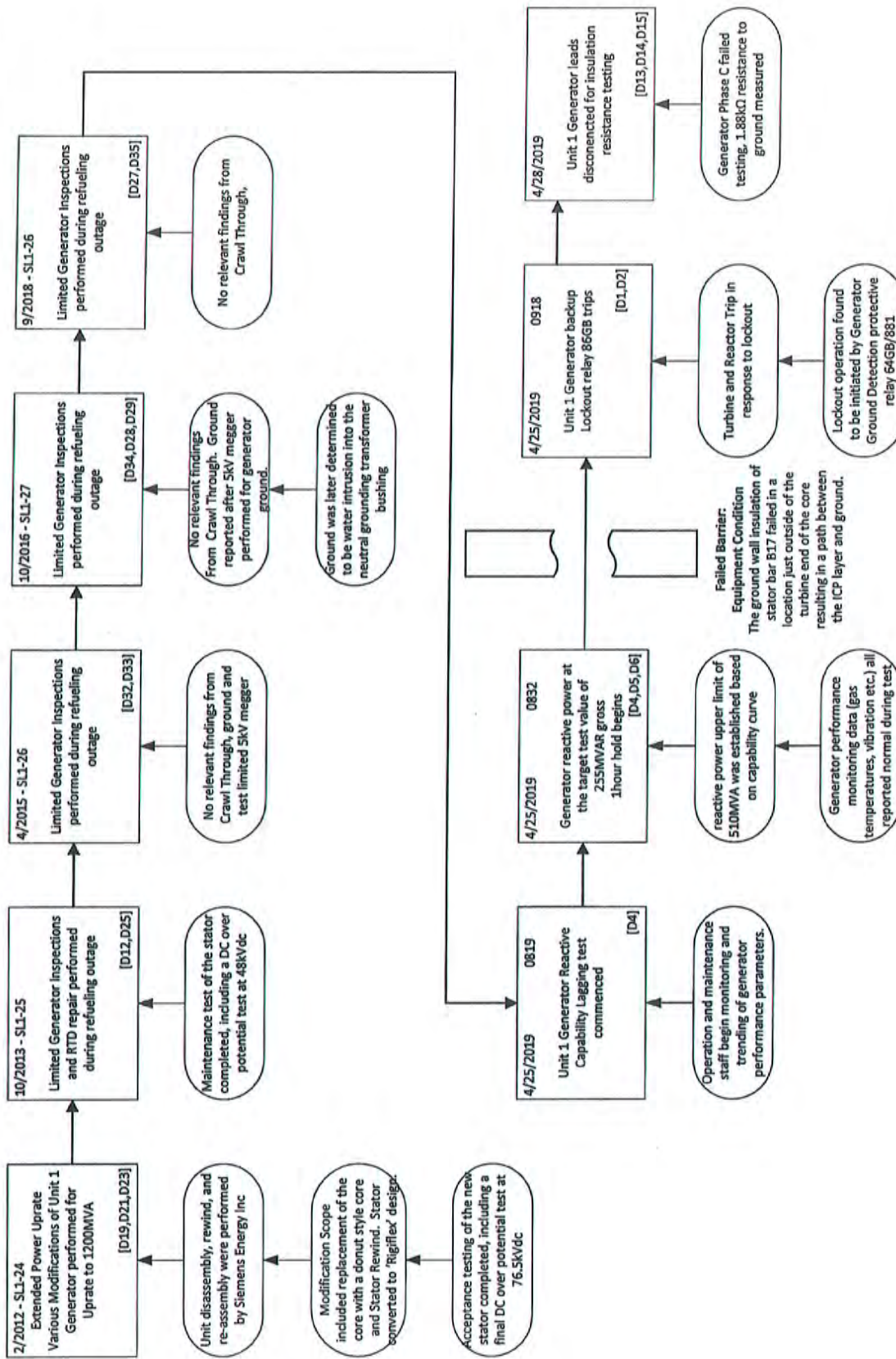

ID	Task Name	Duration	Start	Finish
1	<b>CVH RCA Lab Testing</b>	<b>31 days</b>	<b>Tue 5/28/19</b>	<b>Tue 7/9/19</b>
2	Rec Coils & Material at CLT Lab	0 days	Tue 5/28/19	Tue 5/28/19
3	Unpack, Photo Document Coils & Material	2 days	Tue 5/28/19	Wed 5/29/19
4	Measure PSDS Load vs Deflection	2 days	Thu 5/30/19	Fri 5/31/19
5	Measure the height and width of coils	1 day	Thu 5/30/19	Thu 5/30/19
6	Perform tap test on bar	1 day	Fri 5/31/19	Fri 5/31/19
7	Measure OCP resistance	1 day	Fri 5/31/19	Fri 5/31/19
8	Perform inspection of cooling tubes	3 days	Mon 6/3/19	Wed 6/5/19
9	Visual and Microscopic Exam of fault area surface / 2 days isolate and Test rest of coil	2 days	Mon 6/3/19	Tue 6/4/19
10	Section bar / remove fault area	2 days	Wed 6/5/19	Thu 6/6/19
11	Non-Destructive CT exam of bar Section	8 days	Fri 6/7/19	Tue 6/18/19
12	Perform QC tests on coils(2)	8 days	Wed 6/12/19	Fri 6/21/19
13	Tensile test	3 days	Wed 6/12/19	Fri 6/14/19
14	Glass transition temperature	1 day	Mon 6/17/19	Mon 6/17/19
15	Burnout test to measure % organics	2 days	Wed 6/12/19	Thu 6/13/19
16	Soxhlet extraction to separate monomers from insulation	5 days	Mon 6/17/19	Fri 6/21/19
17	IR and PI test at 5 kV	2 days	Fri 6/7/19	Mon 6/10/19
18	Initial 30 kV DC test of non failed coils	3 days	Fri 6/7/19	Tue 6/11/19
19	Prep 2 coils for PF	2 days	Fri 6/7/19	Mon 6/10/19
20	PF Test 2 coils	1 day	Tue 6/11/19	Tue 6/11/19
21	Compressive tests of insulation	3 days	Mon 6/24/19	Wed 6/26/19
22	Measure Resistance of side filler	2 days	Thu 5/30/19	Fri 5/31/19
23	Examination of center filler	1 day	Thu 5/30/19	Thu 5/30/19
24	Measure Tg of center filler	1 day	Fri 5/31/19	Fri 5/31/19
25	Insulation Resistance test of cone pad sample	2 days	Thu 5/30/19	Fri 5/31/19

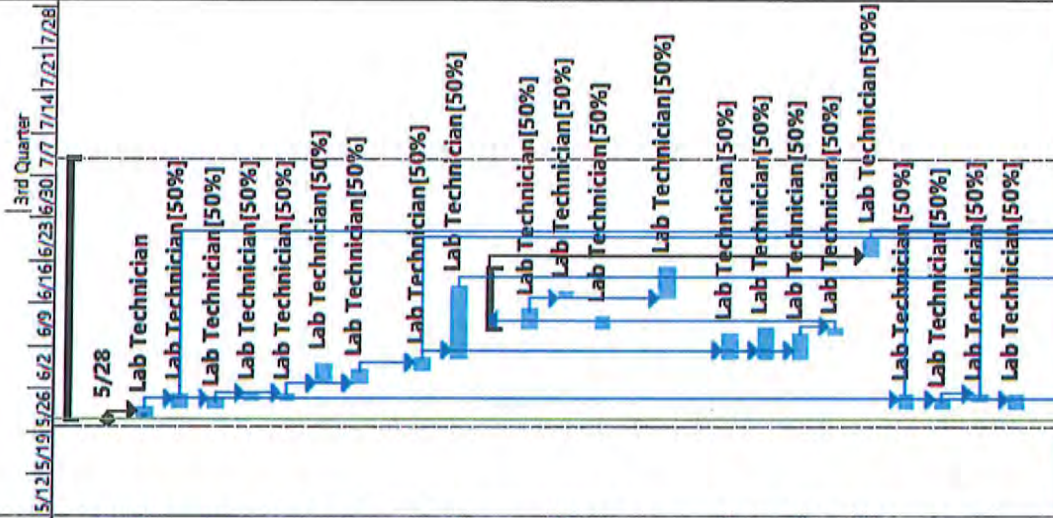



RCE AR 02312208  
Attachment E – Siemens Lab Test Plan and Schedule

ID	Task Name	Duration	Start	Finish
26	Inspect Stator Slot Coupler Wiring	1 day	Thu 5/30/19	Thu 5/30/19
27	Insulation resistance test of slot coupler	1 day	Fri 5/31/19	Fri 5/31/19
28	Measure Tg of wedges for both slots	2 days	Thu 5/30/19	Fri 5/31/19
29	Prep and dielectric breakdown test under oil 2 sections	3 days	Thu 6/27/19	Mon 7/1/19
30	Dissect selected coils document and measurement all dimensions	5 days	Wed 6/19/19	Tue 6/25/19
31	Inspect bakelized bar along the bar length and in the region around the fault location	2 days	Wed 6/26/19	Thu 6/27/19
32	IR Spectroscopy if warranted by inspections	2 days	Wed 6/26/19	Thu 6/27/19
33	Review all data and Report	8 days	Fri 6/28/19	Tue 7/9/19

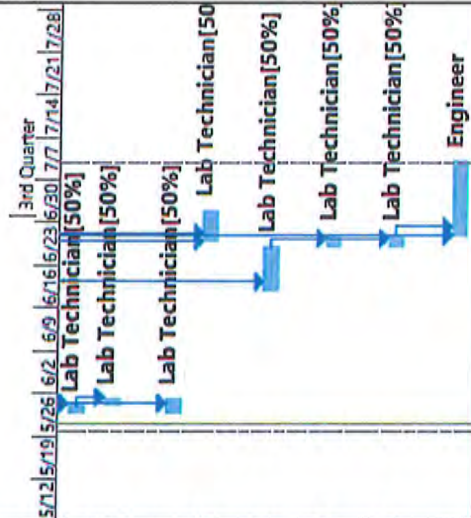

RCE AR 02312208  
 Attachment E – Siemens Lab Test Plan and Schedule

	<p>Task</p> <p>Split</p> <p>Milestone</p> <p>Summary</p> <p>Project Summary</p> <p>Inactive Task</p> <p>Inactive Milestone</p>	<p>Inactive Summary</p> <p>Manual Task</p> <p>Duration-only</p> <p>Manual Summary Rollup</p> <p>Manual Summary</p> <p>Start-only</p> <p>Finish-only</p>	<p>External Tasks</p> <p>External Milestone</p> <p>Deadline</p> <p>Progress</p> <p>Manual Progress</p>
	<p>Project: St Lucie Lab Testing PI                  Date: Tue 5/28/19</p>	<p>Page 3</p>	



REVISION NO.: 18	PROCEDURE TITLE: ROOT CAUSE ANALYSIS	PAGE: 115 of 116
PROCEDURE NO.: PI-AA-100-1005	NUCLEAR FLEET ADMINISTRATIVE	

**ATTACHMENT 18**  
**EVALUATION QUALITY ASSESSMENT GUIDE**  
(Page 1 of 2)

**BACKGROUND:**

The following guidance is presented as an aide when reviewing completed root cause evaluations. Using the criteria presented below should allow a reviewer to adequately assess the quality of the cause evaluation. Some sections may not be applicable for NCAQ RCEs. Guidance is also presented to help categorize the reviewer's conclusions.

Criteria	Satisfactory	Unsatisfactory
Does the Problem Statement address the appropriate issue(s)? <i>(Problem Statement contains OBJECT, DEFECT and CONSEQUENCE)</i>	✓	
Is the Proof Statement correct? <i>(Proof Statement: the "Problem Statement" is caused by identified "Cause" and is corrected by identified "Corrective Action(s)". This identifies if the Problem Statement, the Cause, and the Corrective Action are aligned. The conclusions (cause(s)) are adequately supported by the facts presented in the report analysis.</i>	✓	
Does the analysis adequately identify and investigate potential Organizational and/or Programmatic drivers as appropriate? <i>Every cause evaluation needs to consider potential organizational and programmatic drivers for events. For example, if the cause is human error, there should be documentation substantiating that the cause is limited to the involved personnel.</i>	✓	
Is the Extent of Condition addressed? <i>(Extent of Condition focuses on "where else" this problem exists or could occur). If there are potential extent of condition implications, appropriate corrective actions need to be assigned.</i>	✓	
Is the Extent of Cause addressed? <i>(Extent of Cause focuses on "where else" the cause(s) exist or could occur). If there are potential extent of cause implications, appropriate corrective actions need to be assigned.</i>	✓	
Were the appropriate cause methodology(ies) properly used to analyze the event? <i>(FMEA, Barrier Analysis, Change Analysis, etc.)</i>	✓	
Did the Safety Culture Evaluation properly categorize the causes(s)? <i>(This evaluation is done for each cause. If significant contributors were identified, appropriate corrective actions need to be assigned.)</i>	Will done For final Rev	

REVISION NO.: 18	PROCEDURE TITLE: ROOT CAUSE ANALYSIS	PAGE: 116 of 116
PROCEDURE NO.: PI-AA-100-1005	NUCLEAR FLEET ADMINISTRATIVE	

**ATTACHMENT 18**  
**EVALUATION QUALITY ASSESSMENT GUIDE**  
(Page 2 of 2)

Was Operating Experience (both Internal and External) evaluated appropriately and does the report contain a Repeat Event determination? (if there was previous OE, should it have been expected to prevent this event?)	✓	
Are Corrective Actions targeted at the identified cause and SMART? (Specific, Measurable, Achievable, Relevant and Timely)	✓	
Is the methodology and schedule for the Effectiveness Review appropriate? (Has the effectiveness of the completed actions been adequately challenged?)	✓	

**CONCLUSION:**

Approved: all above are SAT and any/all submitted comments were resolved.

Approved with Comments: all above are SAT; comments could include:

adding another CA or another group to a CA

adding clarifying information that does not substantially change the analysis section

word-smithing of the Cause or CA statement (i.e. intent of sentence does not change)

Failed: any of the above criteria is UNSAT

*Minor comments provided to Evg Dir by S.D.*